

TABLE OF CONTENTS

General Information	2
Warranty	3
Customer's Own Material	4
Fabric Information	5-6
Finishes	7-8
Tablet Edge Specifications	9
SCS Certification	10
Quick-Ship Program	10
Product Customization	10
Shipping Information	11-12

TERMS AND CONDITIONS

INTRODUCTION:

Arcadia is committed to providing quality seating and table products that complement the business environment. Our commitment to our customers extends beyond the products we make: to provide a quality product that is enhanced by the service that supports the product. The Price List herein provides all relevant ordering procedures, conditions of sale and shipping information that will allow you, the customer, an easy path to receiving the quality product that you order. Additionally, our Customer Service staff and Sales Representatives are available to assist with any questions you may have.

PRICING:

All prices reflected in this Price List are for our standard products. These prices supercede any and all prior Price Lists or Supplemental Price Lists. We reserve the right to modify prices without prior notification.

TERMS:

Net 30 days to credit approved accounts. The customer will be liable for any costs incurred in attempting collection of past due amounts, including collection and/or attorney's fees. Past due accounts are subject to a 1% late charge for each month after 30 days.

CREDIT:

A line of credit may be established upon acceptance of satisfactory references, including the completion and signing of our Credit Application Form. All new customers are required to remit 50% of the invoice amount with the placement of the purchase order, with the remaining balance due before the merchandise is released for shipment. Custom furniture specifications may require the remittance of a deposit, for both new and existing customers with an established credit approved account.

ORDER ACKNOWLEDGEMENT:

Order acknowledgement will be made for each order and indicates final production specifications. Customers should review our acknowledgement, notwithstanding any variance in terms and conditions set forth on the customer's order form.

Orders will not be acknowledged or entered for production until all specification information is complete. Upon final acceptance of the order by the factory, orders will be scheduled for production. **For orders specified with COM, scheduling will occur upon confirmation of when materials are expected to arrive. Production begins when scheduling is determined, not when fabrics are received. Please be advised that receipt of any COM/COL or custom finish approval must arrive a minimum of 15 working days prior to the scheduled ship-ment date or the actual ship date may be extended by approximately 5-10 working days.** Contact Customer Service for exact shipping lead times.

ORDERING PROCEDURES:

To avoid unnecessary order entry delays, please be sure each order specifies the following information:

- | | |
|--|--|
| 1. Quantity | 7. Options (list with each specific product) |
| 2. Model number | 8. Drawing for modular seating configurations |
| 3. Item description | 9. Shipping destination, contact name and phone number |
| 4. Size | 10. Purchase order number |
| 5. Finish (wood and/or metal finish) | 11. Special instructions, if any |
| 6. Fabric (including any special instructions) | |

ORDER CHANGES OR CANCELLATIONS:

Arcadia must approve all order changes and/or modifications. Additions or modifications to acknowledged orders may be subject to rescheduling of said order. Cancellations, partial or otherwise, may be subject to restocking fees pending where the order is in the production process. **Any items, once fully manufactured and ready to ship, cannot be cancelled.** Contact Customer Service for applicable charges.

DELIVERY INFORMATION:

All products are shipped F.O.B. La Palma, California, freight prepaid and allowed. Title to the product passes from Arcadia to the purchaser upon receipt of product by the transportation company. The transportation company, however, assumes all responsibility from acceptance of shipment through final delivery.

Freight charges are included in all prices herein. Shipments that do not meet minimum value requirements for respective shipping territories are subject to a freight surcharge. The Delivered Freight Program is explained in detail on page 16.

TERMS AND CONDITIONS

CLAIMS:

Do not refuse merchandise damaged in transit. All shipments are delivered to the transportation company in good condition. Arcadia's liability ceases at that time. If shipment arrives damaged or short, you should first inspect all cartons/crates immediately and note any visual damage or shortages on the delivery receipt. The carrier should be notified immediately to inspect the merchandise and subsequently file a freight claim. If visual damage is not apparent, sign the delivery receipt "No Visual Damage". This will allow recourse for a concealed damage claim. Claims for freight damage, concealed or otherwise, must be filed within 5 days of original delivery date.

Do not destroy packing materials until shipment has been inspected by the carrier. Failure to make claims against Arcadia or its designated carrier within 5 days shall constitute acceptance of the merchandise and a waiver of any defects, errors or shortages discovered upon inspection. See page 11 for detailed instructions if a problem exists at time of delivery.

PRODUCT WARRANTY:

Arcadia products are guaranteed against defects in material and workmanship for a period of ten (10) years from the original invoice date. Pneumatic lifts, tilting mechanisms and casters are warranted to be free from defects in materials and workmanship for a period of four (4) years. Fabrics and electrical/data units are warranted to be free from defects in materials and workmanship for one (1) year or the extent the manufacturer will warrant further, whichever is lesser. Customer's Own Materials (COM/COL) are not included in this warranty.

This warranty does not include damages from normal wear and tear. Normal wear and tear is defined as single shift service (eight (8) hours per day), five (5) days per week. Arcadia assumes no responsibility for repairs to products sustaining damages resulting from user modification, attachments to a product, misuse, abuse, alteration or negligent use of the product.

The warranty provisions set forth above are expressly in lieu of all other warranties, express, statutory or implied in fact or by law, and all remedies against. There are no implied warranties of merchantability or fitness for a particular purpose made by Arcadia in connection with the sale or use of any such article of furniture.

If a defect in material or workmanship has occurred, Arcadia reserves the right to determine if the problem has occurred under normal use. The defective product will be repaired or replaced at the option of Arcadia, free of charge to the customer.

Warranty claims should be submitted, in writing, with a detailed explanation of the occurrence to our Customer Service Department.

WAREHOUSE AND STORAGE:

Due to limited storage space, orders will be shipped when completed. If storage is required, a fee of 3% of the order value will be applied per month, pending availability of space. Additionally, the order will be invoiced and payment due in accordance with the terms of the acknowledgement. Orders for which payment has not been received, the merchandise may be shipped to storage facilities at the customer's expense.

PRODUCT DESIGN:

We reserve the right to alter our product design for the purpose of construction improvement, without notification. Weights and measurements are approximate and subject to change without notice.

CUSTOMER'S OWN MATERIAL

GENERAL INFORMATION:

COM's should be shipped prepaid to:

Arcadia
Attn: COM Department
5593 Fresca Drive
La Palma, CA 90623

All packages should be marked with customer's name, customer's order number and items to be covered. Collect shipments of COM/COL fabrics will not be accepted. Please furnish a sample cutting of COM or COL with the original purchase order so that identification of COM/COL can be verified. In the absence of specific written instructions accompanying the order, fabrics will be cut, seamed and applied at our discretion and at the customer's risk. An additional fee may be assessed for COM or COM materials that are deemed atypical should additional labor be required to cut, sew and/or match said materials.

While we inspect fabrics for mill imperfections, some are difficult to recognize. As such, we cannot be responsible for defects, color inaccuracies, dye lot variations and other flaws and suggest that our customers inspect fabrics before furnishing them. Under no circumstances will we assume responsibility for COM/COL shortages, flaws or other such problems. While we make a concerted effort to control COM/COL fabrics, it is not our responsibility to police the receipt of COM/COL's in order to meet delivery deadlines and we assume that customers are aware of any undue delay in the delivery of their COM/COL fabrics.

FABRIC APPLICATION:

COM fabric is cut "up the roll" as a standard cutting procedure (see chart below). Customer must specify that the fabric be cut in another direction (i.e. "railroad"). We reserve the right to railroad fabric whenever possible to avoid seams in large upholstered areas and/or single cushion units.

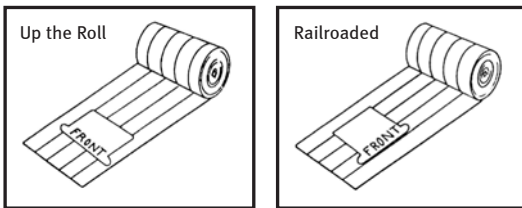

It is imperative that all COM fabrics sent to us are "backed" with, at a minimum, an acrylic or similar backing. We cannot be responsible for stretching of fabrics which are not "backed" subsequent to the upholstery process. Additionally, we cannot be held responsible for the appearance, behavior, quality or performance of any COM as well as COM's that are rolled reversed by the fabric supplier.

The application of patterned fabrics on curved seating units will be stitched to match pattern requirements. Geometric, linear and striped fabrics will be stitched together to provide the best match, however, a "V" pattern may be the result which is not considered to be a flaw. Additionally, due to varied stretch properties among fabrics, slight wrinkling or puddling may occur. Contact our Customer Service Department for any concerns regarding upholstery selections.

YARDAGE REQUIREMENTS:

COM yardage requirements shown in this Price List are based on using fabric which is plain (i.e. non-directional) and a full 54" wide. Fabrics that involve matching repeats and/or are of narrower widths will require additional yardage. Use the chart below to determine the necessary additional yardage for fabrics with repeats:

If you are using a printed or striped fabric with a repeat, use this table:

FABRIC REPEAT	INCREASE COM REQUIREMENT BY:
4.75" and under	0%
5" - 10.75"	12%
11" - 15.75"	18%
16" - 20.75"	25%
21" and over	40%

For upholstery fabrics that are less than 54" wide, please contact Customer Service for additional yardage(s) requirements. Specific models and quantities will determine final yardage amounts.

Yardage requirements may also be less than indicated on large quantity orders. Contact Customer Service with specific models and quantities for exact yardage required.

CUSTOMER'S OWN MATERIAL/FABRIC INFORMATION

CUSTOMER'S OWN LEATHER (COL):

Customer's leather must meet our standard of no more than three defects per hide. We use a conversion factor of 18 square feet per yard, unless otherwise noted herein, to determine the usable square footage for side chairs and executive seating. COL requirements on lounge pieces are noted within each lounge series. COL is priced as Grade 3.

ARCADIA VINYL/POLYURETHANE:

Arcadia offers selected vinyl/polyurethane upholstery options in addition to accepting Customer's Own Vinyl (COV). To determine grade-in pricing for vinyls/polyurethanes not included in Arcadia's standard program, please contact Customer Service for assistance. Customer's Own Vinyl (COV) is priced out as COM.

Due to the inherent stretch properties of 100% polyurethane, puddling or sagging is more likely to occur on the majority of these fabrics. For high traffic areas, alternate upholstery is recommended.

UPHOLSTERY COMBINATIONS:

For fabric, vinyl or leather upholstery combinations, pricing will be based on the following:

- When combining **two** COM/COV/COL fabrics, or fabrics with the same grade, add the following (per unit):
 - › \$45 List for guest, executive/conference chairs and stools
 - › \$65 List for bariatric chairs, lounge seating, ottomans and benches
 - › \$105 List for love seats and chaise lounges
 - › \$130 for sofas
- When combining **three or more** COM/COV/COL fabrics, or fabrics with the same grade, add the following (per unit):
 - › \$55 List for guest, executive/conference chairs and stools
 - › \$75 List for bariatric chairs, lounge seating, ottomans and benches
 - › \$115 List for love seats and chaise lounges
 - › \$140 for sofas
- When combining different grades of fabric, price will be based on the highest grade specified.

MOISTURE BARRIER:

Arcadia offers an optional moisture barrier to seats only on all seating products. Please specify appropriate option code next to chair model number and add the following (per unit).

Option Code	Description	List
MB01	Guest Chairs	\$50
MB02	Bariatric Chairs, Lounge Seating, Ottomans and Single-Seat Benches	\$95
MB03	Love Seats and Two-Seat Benches	\$145
MB04	Three-Seat Benches	\$170
MB05	Sofas	\$215

For products not listed above, please contact Customer Service for assistance.

FIRE RESISTANCE:

Due to the vast choice of fabrics with varying degrees of flame retardancy, we suggest you consult the published technical data of the fabric supplier. Fabrics, vinyl and/or leathers offered by Arcadia meet, as a minimum, California Technical Bulletin #117 or revisions thereto. Although this Bulletin relates to fabrics as well as resilient filling materials (i.e. foam and dacron), all Arcadia products conform to this standard. Consult the individual Arcadia fabric cards to review fabric specifications that are inherent in each fabric offered. Arcadia assumes no responsibility for the flame retardancy of any COM.

Certain jurisdictions require the use of additional fire inhibitors such as the regulation known as California Technical Bulletin #133. Arcadia provides compliance to this standard by way of application of a fire barrier. The cost of TB133 compliance is listed by each product, as applicable. Labels indicating respective fire retardancy compliance levels are placed on the underside of all seating products when required.

FABRIC INFORMATION

FABRIC CARE AND MAINTENANCE:

Most fabrics feature cleaning codes as reflected below:

Code S

- Only mild, pure water-free dry cleaning may be used for cleaning.
- Cleaning by a professional furniture service is recommended.

Code W-S

- Water base cleaning agents and foam may be used for cleaning. This fabric may also be cleaned with mild, water-free solvents.
- Cleaning by a professional furniture service is recommended.

Please refer to individual textile manufacturer's website for additional information regarding the care and maintenance of specific fabrics.

Cleaning of Arcadia leather, Luxor II and faux leather upholstery materials is as follows:

- Remove as much soil or staining material by brushing or wiping with a soft cloth or similar material.
- Use warm water and mild soap to remove most soil and stains.
- Do not use furniture polishes, oils, solvents, abrasive cleaners, ammonia or wax.

ADDITIONAL FABRIC PROGRAMS:

Refer to the presentation cards offered in our commercial catalog for Arcadia's selection of fabrics, polyurethanes and leathers for upholstery. Along with these fabrics, Arcadia, in conjunction with Architex, Camira, Design Tex, Maharam, Mayer, Momentum and Stinson, develops additional fabric programs to allow our customers to simplify the ordering of products and fabrics at one time. Refer to the Textile Partner Program brochure or contact Customer Service for additional information.

Patterns represented in the Textile Partner Program brochure reflect the full offering of our textile partners and may not be compatible with all products. Please contact Customer Service to verify that the selected fabric has been approved for your specification.

Architex® **camira** DESIGN
TEX maharam MAYER FABRICS MOMENTUM
TEXTILES Stinson

FINISHES

WOOD FINISHES:

The Arcadia standard wood finishes available on our products are listed as follows:

Ash	Beech	Maple	White Oak	Walnut
162 White Oak on Ash	12 Natural Beech	10 Natural Maple	14 Natural White Oak	29 Natural Walnut
163 Walnut on Ash	22 Caramel Beech	11 Natural Beech on Maple	18 Slate Grey Oak	30 Cinnamon Walnut
164 Cocoa Ash	27 Ebony Beech	21 Caramel Maple	19 Smoky Umber Oak	35 Bourbon Walnut
165 Kona Ash	33 Cinnamon Beech	26 Ebony Maple	20 Caramel Oak	
166 Smoky Umber Ash	38 Bourbon Beech	31 Cinnamon Maple	25 Ebony Oak	White
167 Slate Grey Ash	43 Autumn Beech	36 Bourbon Maple	32 Cinnamon Oak	01 Pure White
	73 Kona Beech	41 Autumn Maple	37 Bourbon Oak	
	85 Cocoa Beech	71 Kona Maple	44 Autumn Oak	
		115 Cocoa Maple	70 Kona Oak	
			123 Cocoa Oak	

Please refer to the Arcadia Finish Brochure for digital representations or contact Arcadia's Literature Fulfillment Department for actual samples.

Arcadia uses the following wood species within our product lines: Ash, Beech, Maple, White Oak and Walnut. Please note that all models within this Price List are not manufactured in all species of wood. Please refer to individual models to determine wood species that are available.

Arcadia's standard wood finishes encompass a seven-step finishing process culminating with a durable conversion varnish top coat. This process results in a semi-filled, open-pore finish on all products. Full-filled finishes are available at an upcharge which can vary from 15-20%. Full-filled finishes simply fill in the open pores within the wood itself. In some cases, there may appear to be rubbing or fine abrasion lines in this finish. This is characteristic of the required method of rubbing, not an indication of an inferior finish, and can usually be mitigated by rewaxing the furniture.

As part of our finishing process, we best match the standard finish or a customer's custom finish on the appropriate wood species in which the product is manufactured.

CUSTOM FINISHES:

Custom wood finishes are available on our standard veneers and hardwoods. To match a custom finish, please submit a 2" x 3" (minimum size) sample for approval. A factory strike-off will be generated and sent to our customers for final approval. **We must receive the customer approved strike-off at the factory at least 15 working days prior to the scheduled ship date, otherwise the ship date may be delayed by 5-10 working days.**

For custom wood finishing, please add one-time upcharge of \$400 List per color per order for all products.

For custom paint finishes, please contact Customer Service for approvals and pricing. Please note that longer lead-times may apply.

FINISH MAINTENANCE:

As with all fine finishes, care should be taken to protect the finish from sharp, unprotected objects. The top coat has a natural characteristic to repel the most common liquids used around wood components, yet spills or soil marks should be cleaned up immediately to avoid moisture seeping into open-pore areas. Please note that constant polishing and cleaning of the finish may raise the sheen level, whereas neglect in cleaning will dull and possibly abrade the finish.

FINISHES

STANDARD LAMINATE TOPS:

Plastic laminate tops are available on most tablets, modular tables, occasional tables and training/meeting tables. We offer a limited number of standard wood laminates which closely, but do not exactly, match the Arcadia wood finishes. All standard laminates are listed below and are available at no additional upcharge:

Wood Grain Selection

Nevamar WM-8-340T Clear Maple	Wilsonart 7122-K-07 Empire Mahogany
Nevamar WM-0005T Siren Maple	Formica 7739-58 Cocoa Maple
Pionite WM951-SD Honey Maple	Pionite WX421-PV Witchcraft
Wilsonart 7954-38 Natural Rift	Pionite WY160-SD Absolute Acajo
Wilsonart 7937-38 River Cherry	Nevamar WM-0047T Iconic Maple
Wilsonart 7039-78 Windsor Mahogany	Pionite SE101-AW Black Ashwood
Wilsonart 7935K-07 Shaker Cherry	

Solid Color Selection

Formica 459-58 Brite White
Pionite SG228-SD Slate
Wilsonart 1595-60 Black

Matching wood edges, aprons and/or legs to occasional tables specified with Formica Brite White is performed at no additional upcharge. To match other solid color laminates, please contact Customer Service for pricing.

Matching wood edges and/or legs to all our other standard wood grain laminates is also performed at no additional upcharge. For all table lengths, wood grain laminates will run parallel to length of table.

For all table lengths, wood grain laminates will run parallel to length of table.

NON-STANDARD LAMINATE TOPS:

In addition to our standard laminates, we also accept most laminates from the following manufacturers: Formica (standard grade, matte texture), Nevamar, Pionite (standard grade, suede texture), and Wilsonart. Mirror, high gloss and metal laminates are not available.

For non-standard laminates, add \$500 List per color per order. Pre-approval required, please contact Customer Service.

CORIAN® SURFACE MATERIAL:

Corian is available on a variety of seating and table collections, please refer to individual pages for availability and pricing. Except where noted, solid surface tops are affixed to table surface increasing overall table height by $\frac{1}{2}$ ". In some instances, a $\frac{1}{8}$ " reveal may be present. We offer four standard Corian colors which are listed below:

Designer White
Linen
Rain Cloud
Witch Hazel

Corian® is a registered trademark of Dupont.

To order a non-standard Corian color, please specify the name and color number. Contact Customer Service to confirm pricing.

Note: Non-matching seams are present on tables 36" and larger.

BACK-PAINTED GLASS:

Back-painted glass is available on select tablets, tables, conference accessories and inlay accents. Glass is back-painted white and may be used as a writable surface with dry-erase markers. For other colors, please contact Customer Service for pricing.

TABLET EDGE SPECIFICATIONS

With the variety of materials available on rotating tablets, pull-up tables and select occasional tables, the following represents how edge finishes will be applied to each.

For veneer tops, edge finish will always match the top finish color, unless otherwise specified.

For standard laminate tops (laminate cannot be applied to the edge):

- Wood grain laminates, edge finish will match the laminate top color, unless otherwise specified.
- Solid color laminates, edge finish will be natural (clear coat) as standard, unless otherwise specified.

For Corian tops:

- Designer White, Rain Cloud and Linen colors, edge will be white as standard, unless otherwise specified.
- Witch Hazel, edge will be natural (clear coat) as standard, unless otherwise specified.

Edges are also available in all standard wood finishes, please specify. For custom edge finishes, please add one-time upcharge of \$400 List per color, per order.

Material options will vary across product categories, please refer to individual pages for availability.

SCS CERTIFICATION/QUICK-SHIP/CUSTOMIZATION

SCS CERTIFICATION:

As a matter of corporate philosophy, Arcadia is committed to intelligent environmental policies and practices. Standard recycling procedures and ecologically sensible policies and practices have been implemented throughout all aspects of our operations/facilities, and as it relates to new product development and project management. Furthermore, we insist on a similar operational philosophy from our vendor-partners.



In accordance with our ongoing efforts to develop and manufacture products that positively contribute to healthy environments, Arcadia has completed testing for Indoor Air Quality certification across several product categories achieving SCS Indoor Advantage Gold (highest certification available for Indoor Air Quality) for the majority of guest, lounge and bench seating models and SCS Indoor Advantage certification for all executive seating models.

With either SCS Indoor Advantage Gold or SCS Indoor Advantage certification, we not only meet the criteria of BIFMA M-7.1 and X-7.1 (low-emitting office furniture systems and seating) but also the LEED-Commercial Interiors EQ 4.5 credit for Indoor Air Quality of office furniture.

Products achieving SCS certification will be noted with the SCS logo throughout this price list.

Q S QUICK-SHIP PROGRAM:

Designed to provide a full range of products within a condensed time frame, the Quick-Ship Program features a select variety of Arcadia products that are available to ship within ten (10) business days*. Specify from among a host of Quick-Ship fabric options, Arcadia's signature L-1-3 Black leather or Luxor II CD-30 Ebony faux leather to simplify the ordering of products and fabrics at one time (refer to the Quick Ship fabric card to make your selection).

Customer's Own Material (COM) is also available on all Quick-Ship seating products. Flexibility has been an Arcadia trademark from the beginning and accepting COM, even for Quick-Ship, is no exception (ten-day lead time subsequent to receipt of COM fabric).

All Quick-Ship seating and table products are available in ten (10) standard Arcadia wood finishes or in several powdercoat finish options, as applicable, to further expand the flexibility of choice. And, in keeping with Arcadia's commitment to quality and value, all Quick-Ship products carry a Ten-Year Warranty.

Products available on the Quick-Ship program will be designated with the QS logo throughout this price list. Please refer to the Quick-Ship Program brochure for additional information, quantity maximums and available options.

*10-day manufacturing program begins upon approval of purchase order. For orders specified with COM, 10-day manufacturing begins upon receipt of fabric. No minimum quantities are required, however, please observe maximums where noted. Quick-Ship purchase orders should be designated as such and must be placed separately from standard lead-time purchase orders. No split purchase orders allowed.

CUSTOM SIZES OR MODIFICATIONS:

While maintaining design integrity, Arcadia's product modification and custom capabilities illustrate our commitment to providing value as solutions to the customers' needs. As part of our normal production schedule, Arcadia can furnish special sizes, finishes or other modifications upon request. Each request is individually reviewed to determine if any upcharge is required.

Orders requesting special sizes, or modifications different from those published in this Price List, must be authorized by Arcadia.

SHIPPING INFORMATION

FOR YOUR PROTECTION IT IS IMPERATIVE THAT YOU READ THIS NOTICE.

The merchandise you receive has been inspected at our factory to ensure that it is of the highest quality and in perfect condition prior to being shipped to you.

Keep this form and check the following upon receipt of merchandise.

1. Any items/cartons missing? Be sure that you have received the same number of cartons as appears on the delivery receipt. Make note of the cartons missing on the delivery receipt before you sign it.
2. Any items damaged? No matter how slight, all damage to items/cartons should be noted on delivery receipt before you sign. Do not sign or accept merchandise until you have checked all cartons thoroughly. Do not refuse shipments that may be or appear to be damaged.
3. Immediately after delivery, all cartons should be opened and all merchandise inspected for damage. Items may be damaged in transit, even though outer cartons do not show damage.
4. Contact the carrier who delivered the merchandise, in writing, immediately, if any damage is found. By law, any concealed damage must be reported in writing to delivering carrier within 15 days for cartoned shipments and 5 days for blanket-wrap shipments.
5. All cartons must be saved until the freight carrier has made an inspection.
6. If damage or loss claim is necessary, enter said claim with the motor carrier. The carrier's inspector will supply the necessary forms or you can use the standard form for presentation or loss and damage claim.
7. If you need assistance in filing a claim, please contact Customer Service.
8. If incorrect merchandise is received, please contact Customer Service.

UNAUTHORIZED RETURNS:

As per our terms and conditions of sale, we do not accept unauthorized returns. Such returns, should they appear at our factory, are automatically refused by us and they become the responsibility of the shipper and the carrier involved. Please contact Customer Service before returning any merchandise.

In order to resolve the problem at hand as rapidly as possible, please include all information pertinent to the problem. The most pertinent information required is:

1. Reason for return
2. Invoice number
3. Product code numbers
4. Copy of your purchase order

Upon receipt of your request, we will issue proper return authorization or furnish you with instructions in order to settle this matter to your complete satisfaction.

Your complete cooperation is most necessary and sincerely appreciated.

PACKAGING:

As part of our in-force measures to support intelligent environmental practices, Arcadia utilizes blanket-wrapped delivery at every opportunity. Not only does this eliminate the need to dispose of packaging materials but also enables greater efficiency and flexibility when routing shipments.

Please note the following exceptions:

- Applies to shipments within the contiguous U.S. only.
- For orders with 10 or less units, products will typically ship cartoned with the following exceptions:
 - › Co-op Upholstered Units
 - › Hush Private Lounge/Modular Seating Units
 - › Intima Modular Seating Units
 - › Avelina Meeting Tables
 - › Delen Meeting Tables

Due to the scale and/or weight of these products, blanket-wrap shipping is the optimum method.

If cartoning is required, it must be specified and included on purchase orders. Refer to individual product pages for applicable upcharges.

Please refer to page 12 for additional shipping instructions.

SHIPPING INFORMATION

Products shipped via the Arcadia freight program are for normal delivery only and do not include expedited shipping, inside delivery, installation, unpacking or the removal of cartoning materials. Any request for carrier “pre-delivery” notification should be noted on the original purchase order. Arcadia reserves the right to ship via the most appropriate carrier and/or routing on all shipments. If the customer specifies a carrier, other than a pre-approved carrier, freight will ship collect at the customer’s expense via the designated carrier. Any additional costs related to post shipment issues such as reconsignment charges, storage charges, etc., will be the responsibility of the customer.

Title to all goods passes to the purchaser upon receipt by the transportation company. It is the responsibility of the purchaser or consignee to report to the carrier promptly upon receipt, and to settle with the carrier, any subsequent claims for loss or damage. Refer to page 3 for details on reporting freight damages.

Arcadia offers a dual method freight program based upon delivery destinations.

SHIPMENTS TO TERRITORY 1

Deliveries within California, Arizona and Las Vegas, Nevada: Merchandise is shipped F.O.B. La Palma, CA, freight prepaid and allowed. Minimum shipment charge may apply (see below for details). Please refer to page 11 for packaging details.

Customers in CA, AZ and Las Vegas, NV shipping outside Territory 1 must contact Customer Service for applicable charges.

SHIPMENTS TO TERRITORIES 2, 3 AND 4

Deliveries to all other locations (identified as territories 2-4) other than California, Arizona and Las Vegas, Nevada: Merchandise is shipped F.O.B. La Palma, CA, freight prepaid and allowed. Please refer to page 11 for packaging details.

MINIMUM SHIPMENT VALUE REQUIREMENTS - ALL TERRITORIES

This freight program guarantees the product will be delivered freight prepaid to the designated consignee, based upon two factors: 1) destination territory and 2) value of shipment. Using the chart and map below, determine the product destination territory. If the value of the shipment to the destination territory meets the minimum requirement, the shipment is free from freight charges. If the value of the shipment to the destination territory does not meet the minimum requirement, a freight surcharge of **\$60 Net** per shipment for territory 1 or **\$135 NET** per shipment for territories 2-4 will be assessed. **Minimum shipment value is based on COM List, not the graded value.** See chart and map below.

<u>Destination</u>	<u>Minimum Shipment Value</u>	<u>Freight Surcharge</u>
Territory 1	\$1,500 COM List	\$60 NET
Territory 2	\$4,200 COM List	\$135 NET
Territory 3	\$6,000 COM List	\$135 NET
Territory 4	\$7,800 COM List	\$135 NET

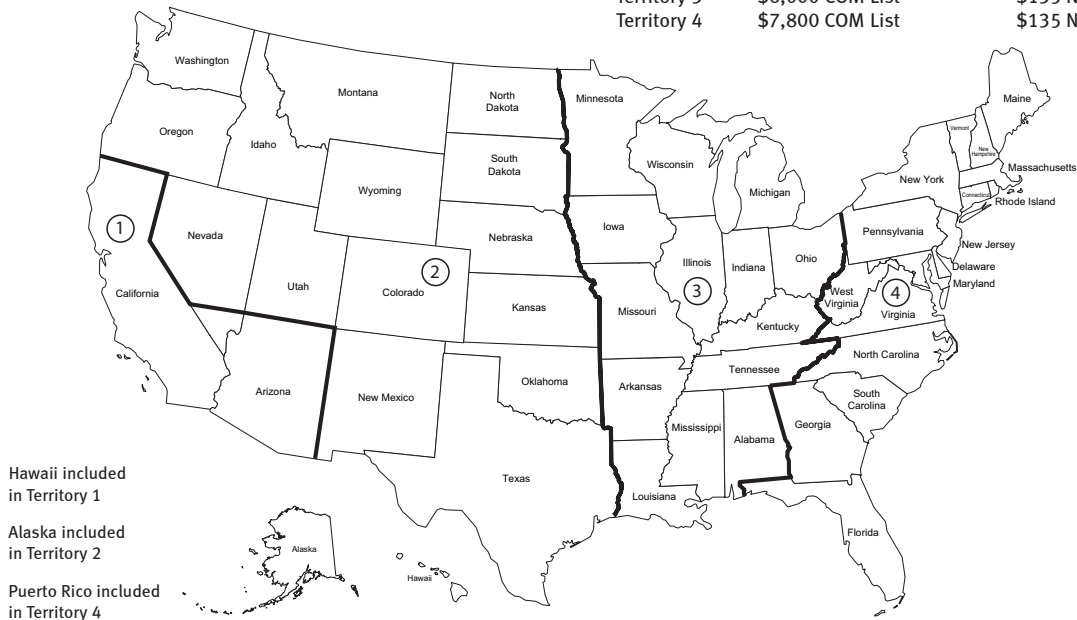

This program does not apply to Will Call orders. For the shipment of textiles and/or components, actual freight charges will apply.

Shipments outside the contiguous U.S. are shipped to the point of embarkation free of charge, if the shipment meets the minimum requirement. All subsequent freight charges will be at the customer’s expense, shipped collect.

Due to the fluctuation of fuel prices, Arcadia reserves the right to impose fuel surcharges to invoices for any shipment(s).

ACHELLA BENCHES

designed by christopher panichella



SIN #711-16

PRODUCT FEATURES:

- Standard base configuration includes wood platform with fixed metal legs.
- Fixed legs available in three finishes: #90 Metallic Silver, #92 Polished Aluminum and #95 Satin Black.
- Maximum weight capacity is 350 lbs. for single seat benches, 700 lbs. for two-seat models and 1050 lbs. for three-seat units.
- Please refer to individual product pages for round and square bench maximum weight capacities.
- Center table manufactured in Maple veneer or laminate.
- Wood platform and center table available in all standard and custom wood finishes available on Maple.
- For custom wood finishes (to platform, center table and/or rotating tablet), please add one-time upcharge of \$400 List per color per order.
- For standard laminates, refer to Standard Finish Card.
- For custom laminates, add \$500 List per color per order. Pre-approval required, please contact Customer Service.
- Non-skid glides available for hard surface floors. Please specify “-NS02B” after model number and add \$20 List per unit.
- Two-tone upholstery examples and yardage requirements featured on pages 6-7.
- All dimensions are nominal.

ROTATING TABLET:

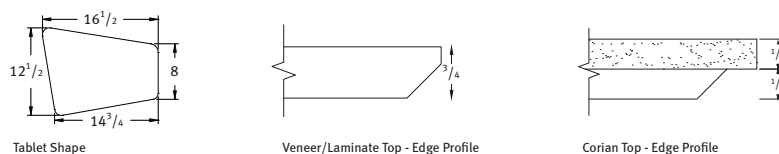

Tablet Shape

Veneer/Laminate Top - Edge Profile

Corian Top - Edge Profile

- Tablet size is $16\frac{1}{2}$ " W x $12\frac{1}{2}$ " D x $\frac{3}{4}$ " thick with 360-degree rotation and is mounted to center of table, unless otherwise specified.
- Three tablet surface options: Maple veneer, laminate or Corian.
- Corian offered in four standard colors. For non-standard options, please contact Customer Service for pricing.
- For maximum durability, a laminate or Corian surface with a clear coat edge finish is recommended.
- Tablet mounting post will match bench leg finish as standard, unless otherwise specified. For polished aluminum leg finish, post will be #91 Chrome (post not available in polished aluminum).

CORIAN® COLORS:

Designer White
Linen
Rain Cloud
Witch Hazel

Corian® is a registered trademark of Dupont.

ACHELLA BENCHES

designed by christopher panichella



SIN #711-16

TABLET EDGE FINISH SPECIFICATIONS:

- For veneer tops, edge finish will always match the top finish color, unless otherwise specified.
- For standard laminate tops (laminate cannot be applied to the edge):
 - › Wood grain laminates, edge finish will match the laminate top color, unless otherwise specified.
 - › Solid color laminates, edge finish will be natural (clear coat) as standard, unless otherwise specified.
- For Corian tops:
 - › Designer White, Rain Cloud and Linen colors, edge will be white as standard, unless otherwise specified.
 - › Witch Hazel, edge will be natural (clear coat) as standard, unless otherwise specified.
- Edges are also available in all standard wood finishes, please specify. For custom edge finishes, please add one-time upcharge of \$400 List per color, per order.

POWER UNITS:

- For placement on center table models only.
- PB1 and PB2 dimensions: 5³/₄" W x 2¹/₂" D
- PB3 dimensions: 6¹/₂" W x 2¹/₂" D
- Metallic Silver or White finish with 108" electrical cord.
- UL listed.

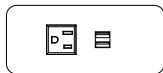

PB1

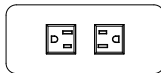

PB2

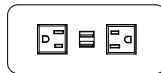

PB3

- PB1 unit features one outlet and two USB charging ports.
- PB2 unit features two outlets.
- PB3 unit features two outlets and two USB charging ports.

NOTES:

- Standard base configuration includes wood platform with fixed metal legs.
- Wood platform available in all standard and custom wood finishes on Maple.
- Metal legs available in three finishes: #90 Metallic Silver, #92 Polished Aluminum and #95 Satin Black.
- Refer to page 6 for two-tone upholstery examples and yardage requirements.

SPECIFY:

1. Model number
2. Wood platform finish
3. Leg finish
4. Upholstery selection
5. Options, as applicable

ORDERING EXAMPLE:

#7212-T-TAC01

Two-Seat Bench, Center Table
Rotating Tablet

ACHELLA BENCHES

designed by christopher panichella

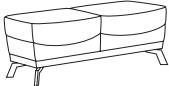
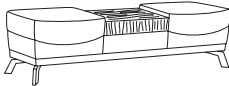
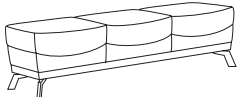

SIN #711-16

MODEL NUMBER	PRODUCT SPECIFICATIONS	FABRIC GRADES							LEATHER GRADES						
		COM	1	2	COL			4	5	6	7	8	L1	L2	L3
7211 	Single Seat Bench W 22 D 20 H 18 2 Yds. 28 lbs. COL 40 Sq. Ft. TB 133, add \$96 List	1249	1363	1390	1438	1487	1533	1581	1625	1674	1894	2056	2213		
7212 	Two-Seat Bench W 44 D 20 H 18 2 1/2 Yds. 45 lbs. COL 50 Sq. Ft. TB 133, add \$120 List	1532	1674	1708	1769	1829	1887	1947	2002	2063	2338	2540	2737		
7212-T 	Two-Seat Bench with Center Table W 66 D 20 H 18 2 3/4 Yds. 84 lbs. COL 55 Sq. Ft. TB 133, add \$132 List	1950	2106	2144	2210	2277	2340	2407	2467	2534	2837	3059	3276		
7213 	Three-Seat Bench W 66 D 20 H 18 4 1/4 Yds. 70 lbs. COL 85 Sq. Ft. TB 133, add \$204 List	1905	2146	2204	2307	2410	2508	2611	2704	2807	3275	3619	3954		

OPTIONS (XXXX - REFERS TO BENCH MODEL NUMBER)

MODEL	DESCRIPTION	LIST
XXXX-TAC01	Veneer/Laminate Rotating Tablet	326
XXXX-TAC01-CO	Corian Rotating Tablet	629
XXXX-PB1-S	Power Band 1 (one power, two USB), Silver	413
XXXX-PB1-W	Power Band 1 (one power, two USB), White	413
XXXX-PB2-S	Power Band 2 (dual power), Silver	322
XXXX-PB2-W	Power Band 2 (dual power), White	322
XXXX-PB3-S	Power Band 3 (dual power, two USB), Silver	429
XXXX-PB3-W	Power Band 3 (dual power, two USB), White	429
XXXX-NS02B	Non-Skid Glides	20

ACHELLA BENCHES

designed by christopher panichella



SIN #711-16

NOTES:



- Standard base configuration includes wood platform with fixed metal legs.
- Wood platform available in all standard and custom wood finishes on Maple.
- Metal legs available in three finishes: #90 Metallic Silver, #92 Polished Aluminum and #95 Satin Black.
- Refer to page 6 for two-tone upholstery examples and yardage requirements.

SPECIFY:

1. Model number
2. Wood platform finish
3. Leg finish
4. Upholstery selection
5. Options, as applicable

ORDERING EXAMPLE:

#7232-NS02B
30" Square Bench
Non-Skid Glides

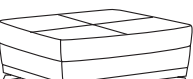
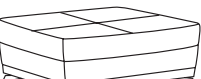
MODEL NUMBER	PRODUCT SPECIFICATIONS	FABRIC GRADES										LEATHER GRADES				
		COM	COL										L1	L2	L3	
7231 	24" Square Bench W 24 D 24 H 18 1 1/2 Yds. 39 lbs. COL 30 Sq. Ft. TB 133, add \$72 List	1234	1320	1340	1376	1412	1447	1483	1516	1553	1718	1839	1957			
7232 	30" Square Bench W 30 D 30 H 18 2 3/4 Yds. 50 lbs. COL 55 Sq. Ft. TB 133, add \$132 List	1465	1621	1659	1725	1792	1855	1922	1982	2049	2352	2574	2791			
7233 	36" Square Bench W 36 D 36 H 18 3 Yds. 71 lbs. COL 60 Sq. Ft. TB 133, add \$144 List	1757	1928	1969	2041	2113	2183	2255	2321	2394	2725	2967	3203			
7234 	42" Square Bench W 42 D 42 H 18 3 3/4 Yds. 86 lbs. COL 75 Sq. Ft. TB 133, add \$180 List	1981	2194	2245	2336	2426	2513	2604	2686	2777	3190	3493	3789			
7235 	48" Square Bench W 48 D 48 H 18 3 3/4 Yds. 109 lbs. COL 75 Sq. Ft. TB 133, add \$180 List	2331	2544	2595	2686	2776	2863	2954	3036	3127	3540	3843	4139			

OPTIONS (XXXX - REFERS TO BENCH MODEL NUMBER)

MODEL	DESCRIPTION	LIST	WEIGHT CAPACITY
XXXX-NS02B	Non-Skid Glides	20	#7231 350 lbs. #7232 500 lbs. #7233 700 lbs. #7234 700 lbs. #7235 700 lbs.

NOTES:

- Standard base configuration includes wood platform with fixed metal legs.
- Wood platform available in all standard and custom wood finishes on Maple.
- Metal legs available in three finishes: #90 Metallic Silver, #92 Polished Aluminum and #95 Satin Black.
- Refer to page 7 for two-tone upholstery examples and yardage requirements.

SPECIFY:

- Model number
- Wood platform finish
- Leg finish
- Upholstery selection
- Options, as applicable

ORDERING EXAMPLE:

#7262-NS02B

30" Round Bench
Non-Skid Glides

ACHELLA BENCHES

designed by christopher panichella



SIN #711-16

		COM	1	2	COL			4	5	6	7	8	L1	L2	L3
7260	18" Round Bench 18" Dia. x 18" H 2 Yds. 23 lbs. COL 40 Sq. Ft. TB 133, add \$96 List	1058	1172	1199	1247	1296	1342	1390	1434	1483	1703	1865	2022		
7261	24" Round Bench 24" Dia. x 18" H 2 1/4 Yds. 32 lbs. COL 45 Sq. Ft. TB 133, add \$108 List	1227	1355	1386	1440	1494	1546	1601	1650	1705	1953	2135	2312		
7262	30" Round Bench 30" Dia. x 18" H 2 1/2 Yds. 41 lbs. COL 45 Sq. Ft. TB 133, add \$108 List	1440	1568	1599	1653	1707	1759	1814	1863	1918	2166	2348	2525		
7263	36" Round Bench 36" Dia. x 18" H 3 Yds. 72 lbs. COL 60 Sq. Ft. TB 133, add \$144 List	1726	1897	1938	2010	2082	2152	2224	2290	2363	2694	2936	3172		
7264	42" Round Bench 42" Dia. x 18" H 3 1/4 Yds. 85 lbs. COL 65 Sq. Ft. TB 133, add \$156 List	2172	2357	2401	2480	2558	2633	2712	2783	2862	3220	3483	3739		
7265	48" Round Bench 48" Dia. x 18" H 3 1/2 Yds. 105 lbs. COL 70 Sq. Ft. TB 133, add \$168 List	2493	2692	2740	2824	2909	2990	3074	3151	3236	3622	3905	4180		

OPTIONS (XXXX - REFERS TO BENCH MODEL NUMBER)

MODEL	DESCRIPTION	LIST	WEIGHT CAPACITY
XXXX-NS02B	Non-Skid Glides	20	#7260 350 lbs. #7261 350 lbs. #7262 350 lbs. #7263 500 lbs. #7264 700 lbs. #7265 700 lbs.

ACHELLA BENCHES

designed by christopher panichella



UPHOLSTERY COMBINATIONS:

For fabric, vinyl or leather upholstery combinations, refer to the pricing below:

- When combining **two** COM/COV/COL fabrics, or fabrics with the same grade, price will be \$65 List (per unit).
 - When combining **three or more** COM/COV/COL fabrics, or fabrics with the same grade, price will be \$75 List (per unit).
 - When combining different grades of fabric, price will be based on the highest grade specified.
- Two-tone upholstery examples and yardage requirements for the most common combinations are listed below. Additional combinations available, please contact Customer Service for yardage requirements and pricing.
 - Note: Yardage amounts are based on fabric which is plain (i.e. non-directional) and a full 54" wide.
 - **Appropriate upholstery code must be included on order.**

SIN #711-16

ACHELLA SCALLOPED BENCH SERIES



Code AB1
Model COM Requirement
 7211 Seat Cushion = 1 yd.
 Seat Box = 3/4 yd.

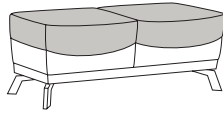

Code AB2
Model COM Requirement
 7212 Seat Cushion = 1 3/4 yds.
 Seat Box = 1 1/4 yds.

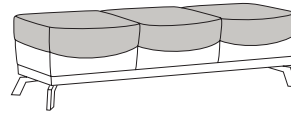

Code AB3
Model COM Requirement
 7213 Seat Cushion = 2 1/2 yds.
 Seat Box = 1 1/2 yds.

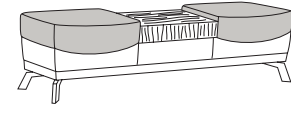

Code AB4
Model COM Requirement
 7212-T Seat Cushion = 1 3/4 yds.
 Seat Box = 1 1/4 yds.

ACHELLA SQUARE BENCH SERIES

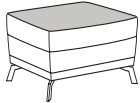

Code AB5
Model COM Requirement
 7231 Top of Seat Cushion = 3/4 yd.
 Balance of Bench = 1 yd.

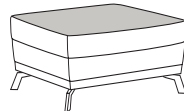

Code AB6
Model COM Requirement
 7232 Top of Seat Cushion = 1 yd.
 Balance of Bench = 2 1/4 yds.

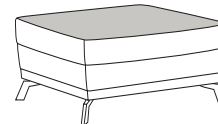

Code AB7
Model COM Requirement
 7233 Top of Seat Cushion = 1 1/4 yds.
 Balance of Bench = 2 1/4 yds.



Code AB8
Model COM Requirement
 7234 Top of Seat Cushion = 1 1/4 yds.
 Balance of Bench = 2 1/4 yds.

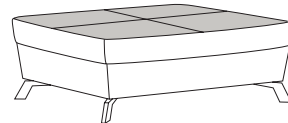

Code AB9
Model COM Requirement
 7235 Top of Seat Cushion = 1 1/2 yds.
 Balance of Bench = 2 1/4 yds.

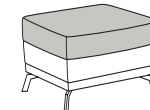

Code AB10
Model COM Requirement
 7231 Seat Cushion = 1 1/4 yds.
 Seat Box = 3/4 yd.

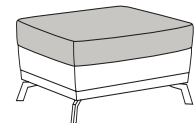

Code AB11
Model COM Requirement
 7232 Seat Cushion = 2 yds.
 Seat Box = 1 1/4 yds.

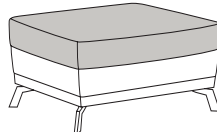

Code AB12
Model COM Requirement
 7233 Seat Cushion = 2 1/4 yds.
 Seat Box = 1 1/4 yds.

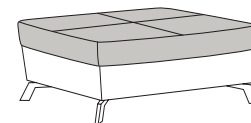

Code AB13
Model COM Requirement
 7234 Seat Cushion = 2 1/4 yds.
 Seat Box = 1 1/4 yds.

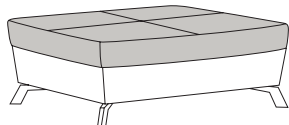

Code AB14
Model COM Requirement
 7235 Seat Cushion = 2 3/4 yds.
 Seat Box = 1 1/4 yds.

UPHOLSTERY COMBINATIONS:

For fabric, vinyl or leather upholstery combinations, refer to the pricing below:

- When combining **two** COM/COV/COL fabrics, or fabrics with the same grade, price will be \$65 List (per unit).
- When combining **three or more** COM/COV/COL fabrics, or fabrics with the same grade, price will be \$75 List (per unit).
- When combining different grades of fabric, price will be based on the highest grade specified.

- Two-tone upholstery examples and yardage requirements for the most common combinations are listed below. Additional combinations available, please contact Customer Service for yardage requirements and pricing.
- Note: Yardage amounts are based on fabric which is plain (i.e. non-directional) and a full 54" wide.
- **Appropriate upholstery code must be included on order.**

ACHELLA BENCHES

designed by christopher panichella



SIN #711-16

ACHELLA ROUND BENCH SERIES

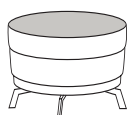

Code AB15

Model COM Requirement
7260 Top of Seat Cushion = 3/4 yd.
Balance of Bench = 1 1/4 yds.

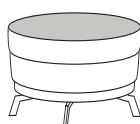

Code AB16

Model COM Requirement
7261 Top of Seat Cushion = 1 yd.
Balance of Bench = 1 1/4 yds.

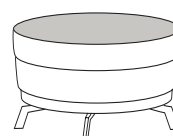

Code AB17

Model COM Requirement
7262 Top of Seat Cushion = 1 yd.
Balance of Bench = 1 1/4 yds.

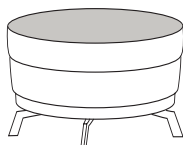

Code AB18

Model COM Requirement
7263 Top of Seat Cushion = 1 1/4 yds.
Balance of Bench = 2 yds.

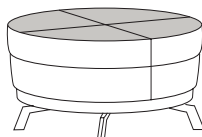

Code AB19

Model COM Requirement
7264 Top of Seat Cushion = 1 1/2 yds.
Balance of Bench = 2 1/4 yds.

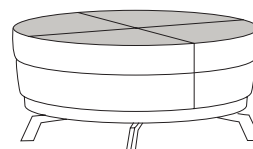

Code AB20

Model COM Requirement
7265 Top of Seat Cushion = 1 1/2 yds.
Balance of Bench = 2 yds.

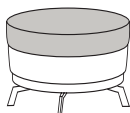

Code AB21

Model COM Requirement
7260 Seat Cushion = 1 yd.
Seat Box = 3/4 yd.

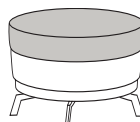

Code AB22

Model COM Requirement
7261 Seat Cushion = 1 1/4 yds.
Seat Box = 3/4 yd.

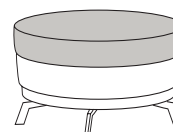

Code AB23

Model COM Requirement
7262 Seat Cushion = 1 1/2 yds.
Seat Box = 1 yd.

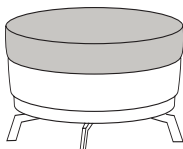

Code AB24

Model COM Requirement
7263 Seat Cushion = 2 yds.
Seat Box = 1 1/4 yds.

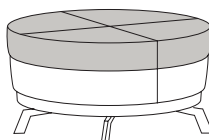

Code AB25

Model COM Requirement
7264 Seat Cushion = 2 1/4 yds.
Seat Box = 1 1/4 yds.

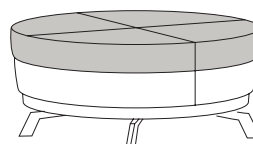

Code AB26

Model COM Requirement
7265 Seat Cushion = 2 1/2 yds.
Balance of Bench = 1 1/4 yds.

ACHELLA LOUNGE

designed by christopher panichella



SIN #711-16

PRODUCT FEATURES:

- Fixed seat cushion.
- Standard base configuration includes wood platform with fixed metal legs or casters.
- Wood platform available in all standard and custom wood finishes on Maple.
- For custom wood finishes (to platform and/or tablet), please add one-time upcharge of \$400 List per color per order.
- Each unit comes standard with four (4) 5" high cast aluminum legs.
- Metal legs available in three finishes: #90 Metallic Silver, #92 Polished Aluminum and #95 Satin Black.
- Mobile version comes standard with two locking casters in rear and two non-locking casters in front.
- Soft-tread casters available, silver color only. Please specify "-C05" and add \$50 List per set (includes 4 casters).
- Non-skid glides available for hard surface floors. Please specify "-NS02B" after model number and add \$20 List per unit.
- Maximum weight capacity is 350 lbs. for lounge chairs, 700 lbs. for love seats and 1000 lbs. for sofas.
- Please refer to page 5 for two-tone upholstery examples, yardage requirements and pricing.
- Percentage of sales is donated to The Common Thread for the Cure, an organization established to unite the furnishings industry in the battle against breast cancer.
- All dimensions are nominal.

ROTATING TABLET:

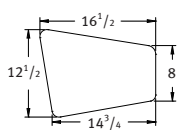

Tablet Shape

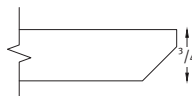

Veneer/Laminate Top - Edge Profile

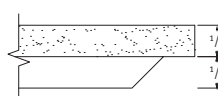

Corian Top - Edge Profile

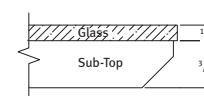

Back-Painted Glass Top - Edge Profile

- Rotating tablet affixed to right arm or left arm, as specified.
- Tablet size is $16\frac{1}{2}$ " W x $12\frac{1}{2}$ " D x $\frac{3}{4}$ " thick and features 180-degree turning radius.
- Four tablet surface options: Maple veneer, laminate, Corian or white back-painted glass.
- All standard and custom wood finishes available on Maple.
- For custom wood finishes (to platform and/or tablets), please add one-time upcharge of \$400 List per color per order.
- For standard laminates, refer to Standard Finish Card.
- For custom laminates, add \$500 List per color per order. Pre-approval required, please contact Customer Service.
- Corian available in four standard colors. For non-standard options, please contact Customer Service for pricing.
- Glass is back-painted white and may be used as a writable surface with dry-erase markers. For other colors, please contact Customer Service for pricing.
- For maximum durability, a laminate or Corian surface with a clear coat edge finish is recommended.

CORIAN® COLORS:

Designer White
Linen
Rain Cloud
Witch Hazel

Corian® is a registered trademark of Dupont.

ACHELLA LOUNGE

designed by christopher panichella



SIN #711-16

EDGE FINISH SPECIFICATIONS:

- For veneer tops, edge finish will always match the top finish color, unless otherwise specified.
- For standard laminate tops (laminate cannot be applied to the edge):
 - › Wood grain laminates, edge finish will match the laminate top color, unless otherwise specified.
 - › Solid color laminates, edge finish will be natural (clear coat) as standard, unless otherwise specified.
- For Corian tops:
 - › Designer White, Rain Cloud and Linen colors, edge will be white as standard, unless otherwise specified.
 - › Witch Hazel edge will be natural (clear coat) as standard, unless otherwise specified.
- Edges are also available in all standard wood finishes, please specify. For custom edge finishes, please add one-time upcharge of \$400 List per color, per order.

CUP HOLDER:

- Dimensions: 5" diameter.
- Cup holder will be mounted to right side, as seated, unless otherwise specified.
- If specified in conjunction with a tablet, cup holder will be mounted to opposite side, unless otherwise specified.
- Cup holder finish is #92 Polished Aluminum, with black laminate insert.

POWER UNITS:

- Unit affixed to right side, as seated, unless otherwise specified.
- If specified in conjunction with a tablet, power unit will be mounted to same side as tablet, unless otherwise specified.
- PB1 and PB2 dimensions: 5³/₄" W x 2¹/₂" D
- PB3 dimensions: 6¹/₂" W x 2¹/₂" D
- Metallic Silver or White finish with 108" electrical cord.
- UL listed.



PB1

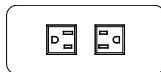

PB2



PB3

- PB1 unit features one outlet and two USB charging ports.
- PB2 unit features two outlets.
- PB3 unit features two outlets and two USB charging ports.

NOTES:

- Standard base configuration includes wood platform with fixed metal legs.
- Wood platform available in all standard and custom wood finishes on Maple.
- Metal legs available in three finishes: #90 Metallic Silver, #92 Polished Aluminum and #95 Satin Black.
- Refer to page 5 for two-tone upholstery examples and yardage requirements.

SPECIFY:

- Model number
- Wood platform finish
- Leg finish
- Upholstery selection
- Options, as applicable

ORDERING EXAMPLE:

#2701-TAR01-PB1-S



Lounge Chair
Veneer Tablet, Right
Power Band 1 Unit, Silver

**ACHELLA
LOUNGE**

designed by christopher panichella

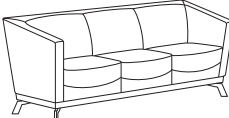

SIN #711-16

MODEL NUMBER	PRODUCT SPECIFICATIONS	FABRIC GRADES								LEATHER GRADES			
		COM	1	2	COL			6	7	8	L1	L2	L3
2701 	Lounge Chair W 31½ D 28 H 32 Seat Height 18 Inside Seat Width 22½ Inside Seat Depth 18½ Arm Height 29½ 4½ Yds. 59 lbs. COL 90 Sq. Ft. TB 133, add \$216 List	1613	1869	1930	2039	2147	2251	2360	2459	2568	3064	3428	3782
2702 	Love Seat W 53 D 28 H 32 Seat Height 18 Inside Seat Width 44 Inside Seat Depth 18½ Arm Height 29½ 6¾ Yds. 90 lbs. COL 135 Sq. Ft. TB 133, add \$324 List	2165	2548	2640	2803	2966	3122	3285	3434	3597	4341	4887	5419
2703 	Sofa W 75½ D 28 H 32 Seat Height 18 Inside Seat Width 66½ Inside Seat Depth 18½ Arm Height 29½ 8 Yds. 115 lbs. COL 160 Sq. Ft. TB 133, add \$384 List	2865	3319	3428	3621	3815	3999	4193	4369	4562	5444	6091	6721

OPTIONS (XXXX - REFERS TO CHAIR MODEL NUMBER)

MODEL	DESCRIPTION	LIST
XXXX-TAR01	Veneer/Laminate Rotating Tablet, Right (as seated)	356
XXXX-TAL01	Veneer/Laminate Rotating Tablet, Left (as seated)	356
XXXX-TAR01-CO	Corian Rotating Tablet, Right (as seated)	659
XXXX-TAL01-CO	Corian Rotating Tablet, Left (as seated)	659
XXXX-TAR01-PG	Back-Painted Glass Rotating Tablet, Right (as seated)	514
XXXX-TAL01-PG	Back-Painted Glass Rotating Tablet, Left (as seated)	514
XXXX-PB1-S	Power Band 1 (one power, two USB), Silver	413
XXXX-PB1-W	Power Band 1 (one power, two USB), White	413
XXXX-PB2-S	Power Band 2 (dual power), Silver	322
XXXX-PB2-W	Power Band 2 (dual power), White	322
XXXX-PB3-S	Power Band 3 (dual power, two USB), Silver	429
XXXX-PB3-W	Power Band 3 (dual power, two USB), White	429
XXXX-CHR02	Cup Holder, Right (as seated)	210
XXXX-CHL02	Cup Holder, Left (as seated)	210
XXXX-NS02B	Non-Skid Glides	20

ACHELLA LOUNGE

designed by christopher panichella



SIN #711-16

NOTES:

- Standard base configuration includes wood platform with casters.
- Wood platform available in all standard and custom wood finishes on Maple.
- Mobile version comes standard with two locking casters in rear and two non-locking casters in front.
- Caster finish is silver as standard.
- Black casters available at no upcharge, please specify.
- Power units not available on mobile units.
- Refer to page 5 for two-tone upholstery examples and yardage requirements.

SPECIFY:

1. Model number
2. Wood platform finish
3. Upholstery selection
4. Options, as applicable

ORDERING EXAMPLE:

#2721-TAR01-CO
Lounge Chair
Corian Tablet Arm, Right

MODEL NUMBER	PRODUCT SPECIFICATIONS	FABRIC GRADES								LEATHER GRADES			
		COM	1	2	COL			6	7	8	L1	L2	L3
2721	 <p>Lounge Chair, Casters W 31½ D 28 H 32 Seat Height 18 Inside Seat Width 22½ Inside Seat Depth 18½ Arm Height 29½ 4½ Yds. 59 lbs. COL 90 Sq. Ft. TB 133, add \$216 List</p>	1613	1869	1930	2039	2147	2251	2360	2459	2568	3064	3428	3782

OPTIONS (XXXX - REFERS TO CHAIR MODEL NUMBER)

MODEL	DESCRIPTION	LIST
XXXX-TAR01	Veneer/Laminate Rotating Tablet, Right (as seated)	356
XXXX-TAL01	Veneer/Laminate Rotating Tablet, Left (as seated)	356
XXXX-TAR01-CO	Corian Rotating Tablet, Right (as seated)	659
XXXX-TAL01-CO	Corian Rotating Tablet, Left (as seated)	659
XXXX-TAR01-PG	Back-Painted Glass Rotating Tablet, Right (as seated)	514
XXXX-TAL01-PG	Back-Painted Glass Rotating Tablet, Left (as seated)	514
XXXX-CHR02	Cup Holder, Right (as seated)	210
XXXX-CHL02	Cup Holder, Left (as seated)	210
XXXX-C05	Soft Tread Casters	50

UPHOLSTERY COMBINATIONS:

For fabric, vinyl or leather upholstery combinations, refer to the pricing below:

- When combining **two** COM/COV/COL fabrics, or fabrics with the same grade, add the following (per unit):
 - › \$65 List for lounge chairs
 - › \$105 List for love seats
 - › \$130 List for sofas
- When combining **three or more** COM/COV/COL fabrics, or fabrics with the same grade, add the following (per unit):
 - › \$75 List for lounge chairs
 - › \$115 List for love seats
 - › \$140 List for sofas
- When combining different grades of fabric, price will be based on the highest grade specified.
- Two-tone upholstery examples and yardage requirements for the most common combinations are listed below. Additional combinations available, please contact Customer Service for yardage requirements and pricing.
- Note: Yardage amounts are based on fabric which is plain (i.e. non-directional) and a full 54" wide.
- **Appropriate upholstery code must be included on order.**

ACHELLA LOUNGE

designed by christopher panichella



SIN #711-16

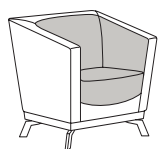

Code AC1
Model COM Requirement
 2701 Inside Back/Inside Arms/
 2721 Seat Cushion = 2 yds.
 Balance of Chair = 2¹/₂ yds.

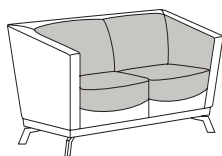

Code AC2
Model COM Requirement
 2702 Inside Back/Inside Arms/
 Seat Cushion = 3³/₂ yds.
 Balance of Love Seat = 3³/₄ yds.

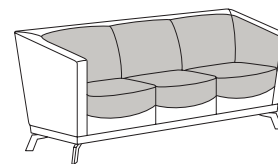

Code AC3
Model COM Requirement
 2703 Inside Back/Inside Arms/
 Seat Cushion = 5 yds.
 Balance of Sofa = 4 yds.

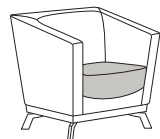

Code AC4
Model COM Requirement
 2701 Seat Cushion Only = 1 yd.
 2721 Balance of Chair = 3³/₄ yds.

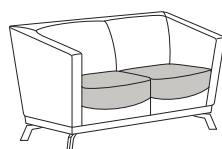

Code AC5
Model COM Requirement
 2702 Seat Cushion Only = 2 yds.
 Balance of Love Seat = 4³/₄ yds.

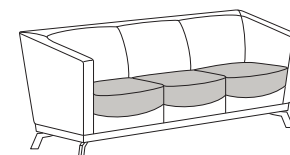

Code AC6
Model COM Requirement
 2703 Seat Cushion Only = 3 yds.
 Balance of Sofa = 6 yds.

ACHELLA MODULAR

designed by christopher panichella



SIN #711-16

LOUNGE PRODUCT FEATURES:

- Available in two back heights: 29¹/₂" or 32¹/₂".
- Each unit comes standard with four (4) 5" high cast aluminum legs.
- Metal legs available in three finishes: #90 Metallic Silver, #92 Polished Aluminum and #95 Satin Black.
- Non-skid glides available for hard surface floors. Please specify "-NS02B" after model number and add \$20 List per unit.
- Optional clean-out vent between seat and back available on 32¹/₂" (high back) lounge models only.



Clean-Out Vent

- Lounge chairs available individually or in modular combinations.
- 350 lb. maximum weight capacity per chair.
- Please refer to pages 16-19 for two-tone upholstery examples, yardage requirements and pricing.
- All dimensions are nominal.

TABLE PRODUCT FEATURES:

- Available in five sizes: 12" wide straight, 22" wide straight, 30-degree narrow, 30-degree wide and 90-degree.
- Three table surface options: Maple veneer, laminate or Corian.
- All standard and custom wood finishes available on Maple.
- For custom wood finishes, please add one-time upcharge of \$400 List per color per order.
- For standard laminates, refer to Standard Finish Card.
- For custom laminates, add \$500 List per color per order. Pre-approval required, please contact Customer Service.
- Corian top is 1/2" thick in lieu of standard table top thickness of 3/4".
- Corian top available in seven standard colors. For non-standard colors, please contact Customer Service for pricing.
- **Table with laminate or Corian top, finish selection for table body must be specified.**
- Each unit comes standard with four (4) 5" high cast aluminum legs.
- Metal legs available in three finishes: #90 Metallic Silver, #92 Polished Aluminum and #95 Satin Black.
- Non-skid glides available for hard surface floors. Please specify "-NS02B" after model number and add \$20 List per table.
- All dimensions are nominal.

CORIAN® COLORS:

Designer White
Linen
Rain Cloud
Witch Hazel

Corian® is a registered trademark of Dupont.

ACHELLA MODULAR

designed by christopher panichella



SIN #711-16

BENCH PRODUCT FEATURES:

- Available in three sizes: 22" wide straight, 30-degree and 90-degree.
- Each unit comes standard with four (4) 5" high cast aluminum legs.
- Metal legs available in three finishes: #90 Metallic Silver, #92 Polished Aluminum and #95 Satin Black.
- Non-skid glides available for hard surface floors. Please specify "-NS02B" after model number and add \$20 List per unit.
- **Note: Upholstery direction must be specified on 90-degree benches when patterned fabrics are selected. In the absence of specific instructions, Arcadia reserves the right to upholster units at our discretion.**

Up the roll

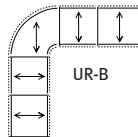
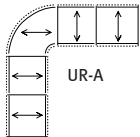

Railroaded

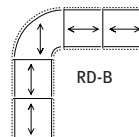
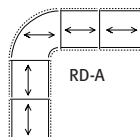

POWER UNITS:

- Available on individual lounge chairs, armless seat end-units and all table sizes.
- PB1 and PB2 dimensions: 5³/₄" W x 2¹/₂" D
- PB3 dimensions: 6¹/₂" W x 2¹/₂" D
- Metallic Silver or White finish with 108" electrical cord.
- UL listed.



PB1

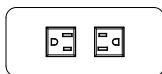

PB2

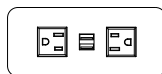

PB3

- PB1 unit features one outlet and two USB charging ports.
- PB2 unit features two outlets.
- PB3 unit features two outlets and two USB charging ports.

MODULAR ARRANGEMENTS:

- Optional ganging bracket available, please specify "GC01" with quantity and add \$50 List per set. One set contains two brackets for connecting two units together.
- Field assembly required.

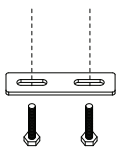

NOTES:

- Lounge units available individually or in modular combinations with tables and benches.
- Each unit comes standard with four (4) 5" high cast aluminum legs.
- Metal legs available in #90 Metallic Silver, #92 Polished Aluminum and #95 Satin Black.
- Refer to pages 16-19 for two-tone upholstery examples and yardage requirements.

SPECIFY:

1. Model number
2. Leg finish
3. Upholstery selection
4. Options, as applicable

ORDERING EXAMPLE:

#2751-NS02B
30-Degree Inside Wedge
Non-Skid Glides

ACHELLA MODULAR

designed by christopher panichella

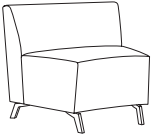
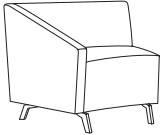
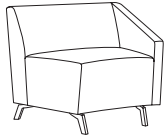
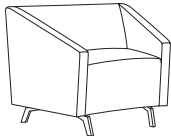

SIN #711-16

MODEL NUMBER	PRODUCT SPECIFICATIONS	FABRIC GRADES								LEATHER GRADES			
		COM	1	2	COL			7	8	L1	L2	L3	
2751	 <p>Lounge Chair, Armless 30-Degree Inside Wedge W 36³/₄ D 28¹/₂ H 29¹/₂ Seat Height 18 Inside Seat Width 20³/₄ - 32¹/₂ Inside Seat Depth 20¹/₄ 3 Yds. 39 lbs. COL 60 Sq. Ft. TB 133, add \$144 List</p>	1263	1434	1475	1547	1619	1689	1761	1827	1900	2231	2473	2709
2752	 <p>Lounge Chair, Right Arm 30-Degree Inside Wedge W 39¹/₄ D 28¹/₂ H 29¹/₂ Seat Height 18 Inside Seat Width 20³/₄ - 32¹/₂ Inside Seat Depth 20¹/₄ Arm Height 25³/₄ 4¹/₂ Yds. 52 lbs. COL 90 Sq. Ft. TB 133, add \$216 List</p>	1470	1726	1787	1896	2004	2108	2217	2316	2425	2921	3285	3639
2753	 <p>Lounge Chair, Left Arm 30-Degree Inside Wedge W 39¹/₄ D 28¹/₂ H 29¹/₂ Seat Height 18 Inside Seat Width 20³/₄ - 32¹/₂ Inside Seat Depth 20¹/₄ Arm Height 25³/₄ 4¹/₂ Yds. 52 lbs. COL 90 Sq. Ft. TB 133, add \$216 List</p>	1470	1726	1787	1896	2004	2108	2217	2316	2425	2921	3285	3639
2754	 <p>Lounge Chair, Right & Left Arm 30-Degree Inside Wedge W 41³/₄ D 28¹/₂ H 29¹/₂ Seat Height 18 Inside Seat Width 20³/₄ - 32¹/₂ Inside Seat Depth 20¹/₄ Arm Height 25³/₄ 5³/₄ Yds. 65 lbs. COL 115 Sq. Ft. TB 133, add \$276 List</p>	1679	2006	2084	2223	2362	2495	2633	2760	2899	3533	3998	4451

OPTIONS (XXXX - REFERS TO CHAIR MODEL NUMBER)

MODEL	DESCRIPTION	LIST
XXXX-NS02B	Non-Skid Glides	20
GC01 (order separately)	Ganging Connector (one set connects two units together)	50

ACHELLA MODULAR

designed by christopher panichella



SIN #711-16

NOTES:

- Lounge units available individually or in modular combinations with tables and benches.
- Each unit comes standard with four (4) 5" high cast aluminum legs.
- Metal legs available in #90 Metallic Silver, #92 Polished Aluminum and #95 Satin Black.
- Refer to pages 16-19 for two-tone upholstery examples and yardage requirements.

SPECIFY:

1. Model number
2. Leg finish
3. Upholstery selection
4. Options, as applicable

ORDERING EXAMPLE:

#2762-NS02B
30-Degree Outside Wedge
Non-Skid Glides

MODEL NUMBER	PRODUCT SPECIFICATIONS	FABRIC GRADES							LEATHER GRADES				
		COM	1	2	COL			8	L1	L2	L3		
2761	Lounge Chair, Armless 30-Degree Outside Wedge W 36 ³ / ₄ D 28 ¹ / ₂ H 29 ¹ / ₂ Seat Height 18 Inside Seat Width 32 ¹ / ₂ -20 ³ / ₄ Inside Seat Depth 20 ¹ / ₄ 2 ³ / ₄ Yds. 39 lbs. COL 55 Sq. Ft. TB 133, add \$132 List	1313	1469	1507	1573	1640	1703	1770	1830	1897	2200	2422	2639
2762	Lounge Chair, Right Arm 30-Degree Outside Wedge W 39 ¹ / ₄ D 28 ¹ / ₂ H 29 ¹ / ₂ Seat Height 18 Inside Seat Width 32 ¹ / ₂ -20 ³ / ₄ Inside Seat Depth 20 ¹ / ₄ Arm Height 25 ³ / ₄ 3 ³ / ₄ Yds. 52 lbs. COL 75 Sq. Ft. TB 133, add \$180 List	1522	1735	1786	1877	1967	2054	2145	2227	2318	2731	3034	3330
2763	Lounge Chair, Left Arm 30-Degree Outside Wedge W 39 ¹ / ₄ D 28 ¹ / ₂ H 29 ¹ / ₂ Seat Height 18 Inside Seat Width 32 ¹ / ₂ -20 ³ / ₄ Inside Seat Depth 20 ¹ / ₄ Arm Height 25 ³ / ₄ 3 ³ / ₄ Yds. 52 lbs. COL 75 Sq. Ft. TB 133, add \$180 List	1522	1735	1786	1877	1967	2054	2145	2227	2318	2731	3034	3330
2764	Lounge Chair, Right & Left Arm 30-Degree Outside Wedge W 41 ³ / ₄ D 28 ¹ / ₂ H 29 ¹ / ₂ Seat Height 18 Inside Seat Width 32 ¹ / ₂ -20 ³ / ₄ Inside Seat Depth 20 ¹ / ₄ Arm Height 25 ³ / ₄ 5 ¹ / ₄ Yds. 65 lbs. COL 105 Sq. Ft. TB 133, add \$252 List	1730	2028	2100	2227	2353	2475	2601	2717	2844	3423	3847	4261

OPTIONS (XXXX - REFERS TO CHAIR MODEL NUMBER)

MODEL	DESCRIPTION	LIST
XXXX-NS02B	Non-Skid Glides	20
GC01 (order separately)	Ganging Connector (one set connects two units together)	50

NOTES:

- Lounge units available individually or in modular combinations with tables and benches.
- Each unit comes standard with four (4) 5" high cast aluminum legs.
- Metal legs available in #90 Metallic Silver, #92 Polished Aluminum and #95 Satin Black.
- Refer to pages 16-19 for two-tone upholstery examples and yardage requirements.

SPECIFY:

1. Model number
2. Leg finish
3. Upholstery selection
4. Options, as applicable

ORDERING EXAMPLE:

#2771-NS02B

Straight
Non-Skid Glides

ACHELLA MODULAR

designed by christopher panichella

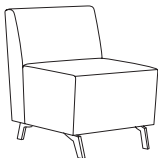
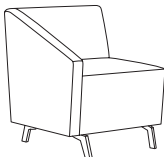
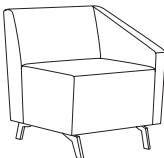
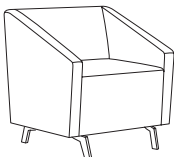

SIN #711-16

MODEL NUMBER	PRODUCT SPECIFICATIONS	FABRIC GRADES							LEATHER GRADES							
		COM	1	2	COL			3	4	5	6	7	8	L1	L2	L3
2771	 <p>Lounge Chair, Armless Straight W 22 D 28¹/₂ H 29¹/₂ Seat Height 18 Inside Seat Width 22 Inside Seat Depth 20¹/₄ 2¹/₂ Yds. 32 lbs. COL 50 Sq. Ft. TB 133, add \$120 List</p>	1209	1351	1385	1446	1506	1564	1624	1679	1740	2015	2217	2414			
2772	 <p>Lounge Chair, Right Arm Straight W 24¹/₂ D 28¹/₂ H 29¹/₂ Seat Height 18 Inside Seat Width 22 Inside Seat Depth 20¹/₄ Arm Height 25³/₄ 3¹/₂ Yds. 46 lbs. COL 70 Sq. Ft. TB 133, add \$168 List</p>	1416	1615	1663	1747	1832	1913	1997	2074	2159	2545	2828	3103			
2773	 <p>Lounge Chair, Left Arm Straight W 24¹/₂ D 28¹/₂ H 29¹/₂ Seat Height 18 Inside Seat Width 22 Inside Seat Depth 20¹/₄ Arm Height 25³/₄ 3¹/₂ Yds. 46 lbs. COL 70 Sq. Ft. TB 133, add \$168 List</p>	1416	1615	1663	1747	1832	1913	1997	2074	2159	2545	2828	3103			
2774	 <p>Lounge Chair, Right & Left Arm Straight W 27 D 28¹/₂ H 29¹/₂ Seat Height 18 Inside Seat Width 22 Inside Seat Depth 20¹/₄ Arm Height 25³/₄ 4³/₄ Yds. 60 lbs. COL 95 Sq. Ft. TB 133, add \$228 List</p>	1625	1895	1960	2074	2189	2299	2414	2518	2633	3157	3541	3915			

OPTIONS (XXXX - REFERS TO CHAIR MODEL NUMBER)

MODEL	DESCRIPTION	LIST
XXXX-NS02B	Non-Skid Glides	20
GC01 (order separately)	Ganging Connector (one set connects two units together)	50

ACHELLA MODULAR

designed by christopher panichella



SIN #711-16

NOTES:

- Lounge units available individually or in modular combinations with tables and benches.
- Each unit comes standard with four (4) 5" high cast aluminum legs.
- Metal legs available in #90 Metallic Silver, #92 Polished Aluminum and #95 Satin Black.
- Refer to pages 16-19 for two-tone upholstery examples and yardage requirements.

SPECIFY:

1. Model number
2. Leg finish
3. Upholstery selection
4. Options, as applicable

ORDERING EXAMPLE:

#2751-H-NS02B
High Back 30-Degree
Inside Wedge
Non-Skid Glides

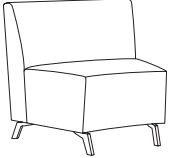
MODEL NUMBER	PRODUCT SPECIFICATIONS	FABRIC GRADES							LEATHER GRADES				
		COM	1	2	COL			6	7	8	L1	L2	L3
2751-H 	High Back Lounge Chair, Armless 30-Degree Inside Wedge W 36 ³ / ₄ D 28 ¹ / ₂ H 32 ¹ / ₂ Seat Height 18 Inside Seat Width 20 ³ / ₄ - 32 ¹ / ₂ Inside Seat Depth 20 ¹ / ₄ 3 ¹ / ₂ Yds. 39 lbs. COL 70 Sq. Ft. TB 133, add \$168 List	1341	1540	1588	1672	1757	1838	1922	1999	2084	2470	2753	3028
		2752-H	High Back Lounge Chair, Right Arm 30-Degree Inside Wedge W 39 ¹ / ₄ D 28 ¹ / ₂ H 32 ¹ / ₂ Seat Height 18 Inside Seat Width 20 ³ / ₄ - 32 ¹ / ₂ Inside Seat Depth 20 ¹ / ₄ Arm Height 25 ³ / ₄ 4 ¹ / ₂ Yds. 52 lbs. COL 90 Sq. Ft. TB 133, add \$216 List	1549	1805	1866	1975	2083	2187	2296	2395	2504	3000
2753-H	High Back Lounge Chair, Left Arm 30-Degree Inside Wedge W 39 ¹ / ₄ D 28 ¹ / ₂ H 32 ¹ / ₂ Seat Height 18 Inside Seat Width 20 ³ / ₄ - 32 ¹ / ₂ Inside Seat Depth 20 ¹ / ₄ Arm Height 25 ³ / ₄ 4 ¹ / ₂ Yds. 52 lbs. COL 90 Sq. Ft. TB 133, add \$216 List	1549	1805	1866	1975	2083	2187	2296	2395	2504	3000	3364	3718
2754-H	High Back Lounge Chair, Right & Left Arm, 30-Degree Inside Wedge W 41 ³ / ₄ D 28 ¹ / ₂ H 32 ¹ / ₂ Seat Height 18 Inside Seat Width 20 ³ / ₄ - 32 ¹ / ₂ Inside Seat Depth 20 ¹ / ₄ Arm Height 25 ³ / ₄ 5 ³ / ₄ Yds. 65 lbs. COL 115 Sq. Ft. TB 133, add \$276 List	1759	2086	2164	2303	2442	2575	2713	2840	2979	3613	4078	4531

OPTIONS (XXXX - REFERS TO CHAIR MODEL NUMBER)

MODEL	DESCRIPTION	LIST
XXXX-NS02B	Non-Skid Glides	20
GC01 (order separately)	Ganging Connector (one set connects two units together)	50

NOTES:

- Lounge units available individually or in modular combinations with tables and benches.
- Each unit comes standard with four (4) 5" high cast aluminum legs.
- Metal legs available in #90 Metallic Silver, #92 Polished Aluminum and #95 Satin Black.
- Refer to pages 16-19 for two-tone upholstery examples and yardage requirements.

SPECIFY:

1. Model number
2. Leg finish
3. Upholstery selection
4. Options, as applicable

ORDERING EXAMPLE:

#2764-H-NS02B

High Back 30-Degree Outside Wedge, Right and Left Arm Non-Skid Glides

**ACHELLA
MODULAR**

designed by christopher panichella

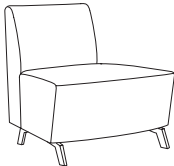
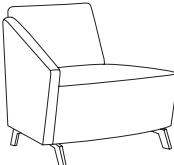
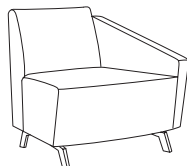
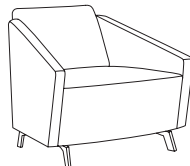

SIN #711-16

MODEL NUMBER	PRODUCT SPECIFICATIONS	FABRIC GRADES							LEATHER GRADES							
		COM	1	2	COL			3	4	5	6	7	8	L1	L2	L3
2761-H 	High Back Lounge Chair, Armless 30-Degree Outside Wedge W 36 ³ / ₄ D 28 ¹ / ₂ H 32 ¹ / ₂ Seat Height 18 Inside Seat Width 32 ¹ / ₂ -20 ³ / ₄ Inside Seat Depth 20 ¹ / ₄ 2 ³ / ₄ Yds. 39 lbs. COL 55 Sq. Ft. TB 133, add \$132 List	1391	1547	1585	1651	1718	1781	1848	1908	1975	2278	2500	2717			
2762-H 	High Back Lounge Chair, Right Arm 30-Degree Outside Wedge W 39 ¹ / ₄ D 28 ¹ / ₂ H 32 ¹ / ₂ Seat Height 18 Inside Seat Width 32 ¹ / ₂ -20 ³ / ₄ Inside Seat Depth 20 ¹ / ₄ Arm Height 25 ³ / ₄ 4 Yds. 52 lbs. COL 80 Sq. Ft. TB 133, add \$192 List	1495	1722	1777	1873	1970	2062	2159	2247	2344	2785	3108	3423			
2763-H 	High Back Lounge Chair, Left Arm 30-Degree Outside Wedge W 39 ¹ / ₄ D 28 ¹ / ₂ H 32 ¹ / ₂ Seat Height 18 Inside Seat Width 32 ¹ / ₂ -20 ³ / ₄ Inside Seat Depth 20 ¹ / ₄ Arm Height 25 ³ / ₄ 4 Yds. 52 lbs. COL 80 Sq. Ft. TB 133, add \$192 List	1495	1722	1777	1873	1970	2062	2159	2247	2344	2785	3108	3423			
2764-H 	High Back Lounge Chair, Right & Left Arm, 30-Degree Outside Wedge W 41 ³ / ₄ D 28 ¹ / ₂ H 32 ¹ / ₂ Seat Height 18 Inside Seat Width 32 ¹ / ₂ -20 ³ / ₄ Inside Seat Depth 20 ¹ / ₄ Arm Height 25 ³ / ₄ 5 ¹ / ₄ Yds. 65 lbs. COL 105 Sq. Ft. TB 133, add \$252 List	1806	2104	2176	2303	2429	2551	2677	2793	2920	3499	3923	4337			

OPTIONS (XXXX - REFERS TO CHAIR MODEL NUMBER)

MODEL	DESCRIPTION	LIST
XXXX-NS02B	Non-Skid Glides	20
GC01 (order separately)	Ganging Connector (one set connects two units together)	50

ACHELLA MODULAR

designed by christopher panichella



NOTES:

- Lounge units available individually or in modular combinations with tables and benches.
- Each unit comes standard with four (4) 5" high cast aluminum legs.
- Metal legs available in #90 Metallic Silver, #92 Polished Aluminum and #95 Satin Black.
- Refer to pages 16-19 for two-tone upholstery examples and yardage requirements.

SPECIFY:

1. Model number
2. Leg finish
3. Upholstery selection
4. Options, as applicable

ORDERING EXAMPLE:

#2771-H-NS02B
High Back Straight
Non-Skid Glides

SIN #711-16

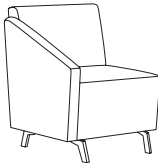
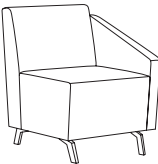
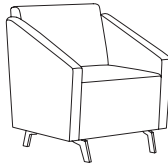
MODEL NUMBER	PRODUCT SPECIFICATIONS	FABRIC GRADES							LEATHER GRADES							
		COM	1	2	COL			3	4	5	6	7	8	L1	L2	L3
2771-H	 <p>High Back Lounge Chair, Armless Straight W 22 D 28¹/₂ H 32¹/₂ Seat Height 18 Inside Seat Width 22 Inside Seat Depth 20¹/₄ 2¹/₂ Yds. 32 lbs. COL 50 Sq. Ft. TB 133, add \$120 List</p>	1286	1428	1462	1523	1583	1641	1701	1756	1817	2092	2294	2491			
2772-H	 <p>High Back Lounge Chair, Right Arm Straight W 24¹/₂ D 28¹/₂ H 32¹/₂ Seat Height 18 Inside Seat Width 22 Inside Seat Depth 20¹/₄ Arm Height 25³/₄ 3³/₄ Yds. 46 lbs. COL 75 Sq. Ft. TB 133, add \$180 List</p>	1495	1708	1759	1850	1940	2027	2118	2200	2291	2704	3007	3303			
2773-H	 <p>High Back Lounge Chair, Left Arm Straight W 24¹/₂ D 28¹/₂ H 32¹/₂ Seat Height 18 Inside Seat Width 22 Inside Seat Depth 20¹/₄ Arm Height 25³/₄ 3³/₄ Yds. 46 lbs. COL 75 Sq. Ft. TB 133, add \$180 List</p>	1495	1708	1759	1850	1940	2027	2118	2200	2291	2704	3007	3303			
2774-H	 <p>High Back Lounge Chair, Right & Left Arm, Straight W 27 D 28¹/₂ H 32¹/₂ Seat Height 18 Inside Seat Width 22 Inside Seat Depth 20¹/₄ Arm Height 25³/₄ 5 Yds. 60 lbs. COL 100 Sq. Ft. TB 133, add \$240 List</p>	1704	1988	2056	2177	2298	2413	2534	2644	2765	3316	3720	4114			

OPTIONS (XXXX - REFERS TO CHAIR MODEL NUMBER)

MODEL	DESCRIPTION	LIST
XXXX-NS02B	Non-Skid Glides	20
GC01 (order separately)	Ganging Connector (one set connects two units together)	50

NOTES:

- Lounge units available individually or in modular combinations with tables and benches.
- Clean-out vent between seat and back.
- Each unit comes standard with four (4) 5" high cast aluminum legs.
- Metal legs available in #90 Metallic Silver, #92 Polished Aluminum and #95 Satin Black.
- Refer to pages 16-19 for two-tone upholstery examples and yardage requirements.

SPECIFY:

1. Model number
2. Leg finish
3. Upholstery selection
4. Options, as applicable

ORDERING EXAMPLE:

#2751-HV-NS02B
 High Back 30-Degree
 Inside Wedge
 Non-Skid Glides

ACHELLA MODULAR

designed by christopher panichella

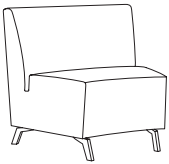
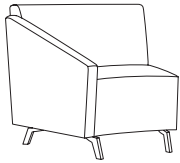
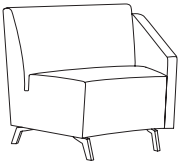
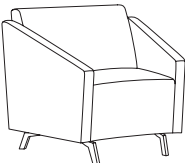

SIN #711-16

MODEL NUMBER	PRODUCT SPECIFICATIONS	FABRIC GRADES								LEATHER GRADES			
		COM	1	2	COL			4	5	6	7	8	L1
2751-HV 	High Back Lounge Chair with Clean-Out, Armless, 30-Degree Inside Wedge W 36 ³ / ₄ D 28 ¹ / ₂ H 32 ¹ / ₂ Seat Height 18 Inside Seat Width 20 ³ / ₄ - 32 ¹ / ₂ Inside Seat Depth 20 ¹ / ₄ 3 ³ / ₄ Yds. 39 lbs. COL 75 Sq. Ft. TB 133, add \$180 List	1406	1619	1670	1761	1851	1938	2029	2111	2202	2615	2918	3214
2752-HV 	High Back Lounge Chair with Clean-Out, Right Arm, 30-Degree Inside Wedge W 39 ¹ / ₄ D 28 ¹ / ₂ H 32 ¹ / ₂ Seat Height 18 Inside Seat Width 20 ³ / ₄ - 32 ¹ / ₂ Inside Seat Depth 20 ¹ / ₄ Arm Height 25 ³ / ₄ 5 ¹ / ₄ Yds. 52 lbs. COL 105 Sq. Ft. TB 133, add \$252 List	1614	1912	1984	2111	2237	2359	2485	2601	2728	3307	3731	4145
2753-HV 	High Back Lounge Chair with Clean-Out, Left Arm 30-Degree Inside Wedge W 39 ¹ / ₄ D 28 ¹ / ₂ H 32 ¹ / ₂ Seat Height 18 Inside Seat Width 20 ³ / ₄ - 32 ¹ / ₂ Inside Seat Depth 20 ¹ / ₄ Arm Height 25 ³ / ₄ 5 ¹ / ₄ Yds. 52 lbs. COL 105 Sq. Ft. TB 133, add \$252 List	1614	1912	1984	2111	2237	2359	2485	2601	2728	3307	3731	4145
2754-HV 	High Back Lounge Chair with Clean-Out, Right & Left Arm 30-Degree Inside Wedge W 41 ¹ / ₄ D 28 ¹ / ₂ H 32 ¹ / ₂ Seat Height 18 Inside Seat Width 20 ³ / ₄ - 32 ¹ / ₂ Inside Seat Depth 20 ¹ / ₄ Arm Height 25 ³ / ₄ 6 ¹ / ₂ Yds. 65 lbs. COL 130 Sq. Ft. TB 133, add \$312 List	1823	2192	2281	2438	2595	2745	2902	3045	3202	3919	4444	4956

OPTIONS (XXXX - REFERS TO CHAIR MODEL NUMBER)

MODEL	DESCRIPTION	LIST
XXXX-NS02B	Non-Skid Glides	20
GC01 (order separately)	Ganging Connector (one set connects two units together)	50

ACHELLA MODULAR

designed by christopher panichella



SIN #711-16

NOTES:

- Lounge units available individually or in modular combinations with tables and benches.
- Clean-out vent between seat and back.
- Each unit comes standard with four (4) 5" high cast aluminum legs.
- Metal legs available in #90 Metallic Silver, #92 Polished Aluminum and #95 Satin Black.
- Refer to pages 16-19 for two-tone upholstery examples and yardage requirements.

SPECIFY:

1. Model number
2. Leg finish
3. Upholstery selection
4. Options, as applicable

ORDERING EXAMPLE:

#2771-H-NS02B
High Back Straight
Non-Skid Glides

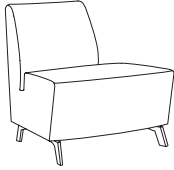
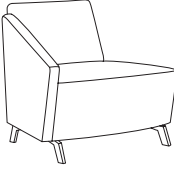
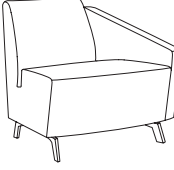
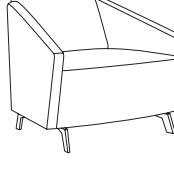
MODEL NUMBER	PRODUCT SPECIFICATIONS	FABRIC GRADES							LEATHER GRADES				
		COM	1	2	COL 3	4	5	6	7	8	L1	L2	L3
2761-HV 	High Back Lounge Chair with Clean-Out, Armless 30-Degree Outside Wedge W 36 ³ / ₄ D 28 ¹ / ₂ H 32 ¹ / ₂ Seat Height 18 Inside Seat Width 32 ¹ / ₂ -20 ³ / ₄ Inside Seat Depth 20 ¹ / ₄ 3 ¹ / ₄ Yds. 39 lbs. COL 65 Sq. Ft. TB 133, add \$156 List	1457	1642	1686	1765	1843	1918	1997	2068	2147	2505	2768	3024
2762-HV 	High Back Lounge Chair with Clean-Out, Right Arm 30-Degree Outside Wedge W 39 ³ / ₄ D 28 ¹ / ₂ H 32 ¹ / ₂ Seat Height 18 Inside Seat Width 32 ¹ / ₂ -20 ³ / ₄ Inside Seat Depth 20 ¹ / ₄ Arm Height 25 ³ / ₄ 4 ¹ / ₂ Yds. 52 lbs. COL 90 Sq. Ft. TB 133, add \$216 List	1665	1921	1982	2091	2199	2303	2412	2511	2620	3116	3480	3834
2763-HV 	High Back Lounge Chair with Clean-Out, Left Arm 30-Degree Outside Wedge W 39 ³ / ₄ D 28 ¹ / ₂ H 32 ¹ / ₂ Seat Height 18 Inside Seat Width 32 ¹ / ₂ -20 ³ / ₄ Inside Seat Depth 20 ¹ / ₄ Arm Height 25 ³ / ₄ 4 ¹ / ₂ Yds. 52 lbs. COL 90 Sq. Ft. TB 133, add \$216 List	1665	1921	1982	2091	2199	2303	2412	2511	2620	3116	3480	3834
2764-HV 	High Back Lounge Chair with Clean-Out, Right & Left Arm 30-Degree Outside Wedge W 41 ¹ / ₄ D 28 ¹ / ₂ H 32 ¹ / ₂ Seat Height 18 Inside Seat Width 32 ¹ / ₂ -20 ³ / ₄ Inside Seat Depth 20 ¹ / ₄ Arm Height 25 ³ / ₄ 5 ³ / ₄ Yds. 65 lbs. COL 115 Sq. Ft. TB 133, add \$276 List	1873	2200	2278	2417	2556	2689	2827	2954	3093	3727	4192	4645

OPTIONS (XXXX - REFERS TO CHAIR MODEL NUMBER)

MODEL	DESCRIPTION	LIST
XXXX-NS02B	Non-Skid Glides	20
GC01 (order separately)	Ganging Connector (one set connects two units together)	50

NOTES:

- Lounge units available individually or in modular combinations with tables and benches.
- Clean-out vent between seat and back.
- Each unit comes standard with four (4) 5" high cast aluminum legs.
- Metal legs available in #90 Metallic Silver, #92 Polished Aluminum and #95 Satin Black.
- Refer to pages 16-19 for two-tone upholstery examples and yardage requirements.

SPECIFY:

1. Model number
2. Leg finish
3. Upholstery selection
4. Options, as applicable

ORDERING EXAMPLE:

#2771-HV-NS02B
 High Back Straight
 Non-Skid Glides

ACHELLA MODULAR

designed by christopher panichella

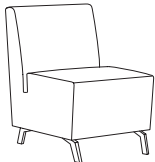
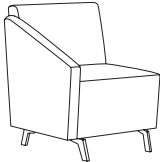
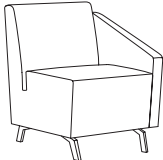
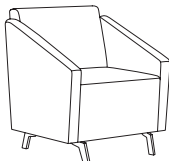

SIN #711-16

MODEL NUMBER	PRODUCT SPECIFICATIONS	FABRIC GRADES								LEATHER GRADES						
		COM	1	2	COL			4	5	6	7	8	L1	L2	L3	
2771-HV 	High Back Lounge Chair with Clean-Out, Armless Straight W 22 D 28 ¹ / ₂ H 32 ¹ / ₂ Seat Height 18 Inside Seat Width 22 Inside Seat Depth 20 ¹ / ₄ 2 ³ / ₄ Yds. 39 lbs. COL 55 Sq. Ft. TB 133, add \$132 List	1351	1507	1545	1611	1678	1741	1808	1868	1935	2238	2460	2677			
2772-HV 	High Back Lounge Chair with Clean-Out, Right Arm Straight W 24 ¹ / ₂ D 28 ¹ / ₂ H 32 ¹ / ₂ Seat Height 18 Inside Seat Width 22 Inside Seat Depth 20 ¹ / ₄ Arm Height 25 ³ / ₄ 4 Yds. 46 lbs. COL 80 Sq. Ft. TB 133, add \$192 List	1560	1787	1842	1938	2035	2127	2224	2312	2409	2850	3173	3488			
2773-HV 	High Back Lounge Chair with Clean-Out, Left Arm Straight W 24 ¹ / ₂ D 28 ¹ / ₂ H 32 ¹ / ₂ Seat Height 18 Inside Seat Width 22 Inside Seat Depth 20 ¹ / ₄ Arm Height 25 ³ / ₄ 4 Yds. 46 lbs. COL 80 Sq. Ft. TB 133, add \$192 List	1560	1787	1842	1938	2035	2127	2224	2312	2409	2850	3173	3488			
2774-HV 	High Back Lounge Chair with Clean-Out, Right & Left Arm Straight W 27 D 28 ¹ / ₂ H 32 ¹ / ₂ Seat Height 18 Inside Seat Width 22 Inside Seat Depth 20 ¹ / ₄ Arm Height 25 ³ / ₄ 5 ¹ / ₄ Yds. 60 lbs. COL 105 Sq. Ft. TB 133, add \$252 List	1769	2067	2139	2266	2392	2514	2640	2756	2883	3462	3886	4300			

OPTIONS (XXXX - REFERS TO CHAIR MODEL NUMBER)		
MODEL	DESCRIPTION	LIST
XXXX-NS02B	Non-Skid Glides	20
GC01 (order separately)	Ganging Connector (one set connects two units together)	50

ACHELLA MODULAR

designed by christopher panichella



NOTES:

- Metal legs available in #90 Metallic Silver, #92 Polished Aluminum and #95 Satin Black.
- Refer to pages 16-19 for two-tone upholstery examples and yardage requirements.

SPECIFY:

1. Model number
2. Leg finish
3. Upholstery selection
4. Options, as applicable

ORDERING EXAMPLE:

#2780-NS02B

Straight Bench
Non-Skid Glides

SIN #711-16

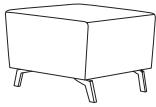
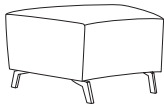
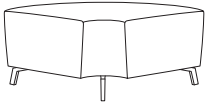
MODEL NUMBER	PRODUCT SPECIFICATIONS	FABRIC GRADES							LEATHER GRADES							
		COM	1	2	COL			3	4	5	6	7	8	L1	L2	L3
2780	 <p>Straight Bench W 22 D 26³/₄ H 18 Seat Height 18 1¹/₂ Yds. 30 lbs. COL 30 Sq. Ft. TB 133, add \$72 List</p>	980	1066	1086	1122	1158	1193	1229	1262	1299	1464	1585	1703			
2785	 <p>30-Degree Bench W 22¹/₂ - 36³/₄ D 26³/₄ H 18 Seat Height 18 2¹/₄ Yds. 30 lbs. COL 45 Sq. Ft. TB 133, add \$108 List</p>	1040	1168	1199	1253	1307	1359	1414	1463	1518	1766	1948	2125			
2786	 <p>90-Degree Bench W 34 D 26³/₄ H 18 Seat Height 18 2¹/₄ Yds. 30 lbs. COL 45 Sq. Ft. TB 133, add \$108 List</p>	1151	1279	1310	1364	1418	1470	1525	1574	1629	1877	2059	2236			

OPTIONS (XXXX - REFERS TO BENCH MODEL NUMBER)

MODEL	DESCRIPTION	LIST
XXXX-NS02B	Non-Skid Glides	20
GC01 (order separately)	Gangng Connector (one set connects two units together)	50

ACHELLA MODULAR

designed by christopher panichella



SIN #711-16

NOTES:



- Available in Maple veneer, laminate or Corian (top surface only).
- Corian top is 1/2" thick in lieu of standard table top thickness of 3/4".
- **Table with laminate or Corian top, finish selection for table body must be specified.**
- Metal legs available in #90 Metallic Silver, #92 Polished Aluminum and #95 Satin Black.
- Refer to page 2 for power unit details.

SPECIFY:

1. Model number
2. Wood finish
3. Leg finish
4. Options, as applicable

ORDERING EXAMPLE:

#2791-CO-PB1-S
12" Straight Table, Corian Top
Power Band 1 Unit, Silver

MODEL NUMBER	PRODUCT SPECIFICATIONS	TABLE TOP FINISH	
		VENEER OR LAMINATE	CORIAN (-CO)
2791 	12" Straight Table W 12 D 25 ¹ / ₄ H 16 27 lbs.	1014	1393
2792 	22" Straight Table W 22 D 25 ¹ / ₄ H 16 43 lbs.	1234	1902

OPTIONS (XXXX - REFERS TO TABLE MODEL NUMBER)

MODEL	DESCRIPTION	LIST
XXXX-PB1-S	Power Band 1 (one power, two USB), Silver	413
XXXX-PB1-W	Power Band 1 (one power, two USB), White	413
XXXX-PB2-S	Power Band 2 (dual power), Silver	322
XXXX-PB2-W	Power Band 2 (dual power), White	322
XXXX-PB3-S	Power Band 3 (dual power, two USB), Silver	429
XXXX-PB3-W	Power Band 3 (dual power, two USB), White	429
XXXX-NS02B	Non-Skid Glides	20
GC01 (order separately)	Ganging Connector (one set connects two units together)	50

ACHELLA MODULAR

designed by christopher panichella



SIN #711-16

NOTES:

- Available in Maple veneer, laminate or Corian (top surface only).
- Corian top is 1/2" thick in lieu of standard table top thickness of 3/4".
- **Table with laminate or Corian top, finish selection for table body must be specified.**
- Metal legs available in #90 Metallic Silver, #92 Polished Aluminum and #95 Satin Black.
- Refer to page 2 for power unit details.



SPECIFY:

1. Model number
2. Wood finish
3. Leg finish
4. Options, as applicable

ORDERING EXAMPLE:

#2796-CO-PB1-S

30-Degree Narrow Table
Corian Top
Power Band 1 Unit, Silver

MODEL NUMBER	PRODUCT SPECIFICATIONS	TABLE TOP FINISH	
		VENEER OR LAMINATE	CORIAN (-CO)
2796 	30-Degree Narrow Table W 20 D 25 ¹ / ₂ H 16 28 lbs.	1183	1792
2797 	30-Degree Wide Table W 28 D 25 ¹ / ₂ H 16 37 lbs.	1404	2244
2798 	90-Degree Table W 43 D 23 H 16 47 lbs.	1533	2706

OPTIONS (XXXX - REFERS TO TABLE MODEL NUMBER)

MODEL	DESCRIPTION	LIST
XXXX-PB1-S	Power Band 1 (one power, two USB), Silver	413
XXXX-PB1-W	Power Band 1 (one power, two USB), White	413
XXXX-PB2-S	Power Band 2 (dual power), Silver	322
XXXX-PB2-W	Power Band 2 (dual power), White	322
XXXX-PB3-S	Power Band 3 (dual power, two USB), Silver	429
XXXX-PB3-W	Power Band 3 (dual power, two USB), White	429
XXXX-NS02B	Non-Skid Glides	20
GC01 (order separately)	Ganging Connector (one set connects two units together)	50

ACHELLA MODULAR

designed by christopher panichella



SIN #711-16

CONFIGURATION EXAMPLES

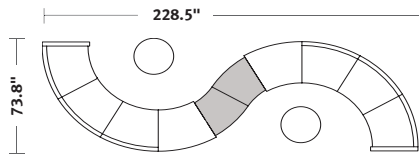

Qty	Model #	Description	COM List
2	2753	Lounge Chair, Left Arm, 30-Degree Inside Wedge (\$1,470 ea)	2,940
4	2751	Lounge Chair, Armless, 30-Degree Inside Wedge (\$1,263 ea)	5,052
2	2785	Bench, 30-Degree Wedge (\$1,040 ea)	2,080
2	2797	Table, 30-Degree Wide (\$1,404 ea)	2,808
<u>2</u>	<u>7262</u>	<u>Achella 30" Round Bench (\$1,440 ea)</u>	<u>2,880</u>
12			15,760

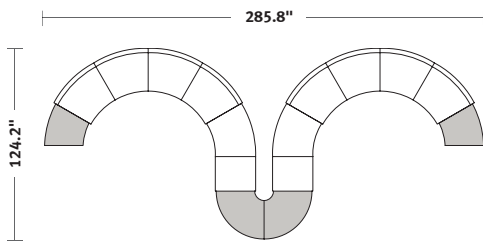

Qty	Model #	Description	COM List
2	2797	Table, 30-Degree Wide (\$1,404 ea)	2,808
8	2751	Lounge Chair, Armless, 30-Degree Inside Wedge (\$1,263 ea)	10,104
2	2785	Bench, 30-Degree Wedge (\$1,040 ea)	2,080
2	2780	Bench, Straight (\$980 ea)	1,960
<u>2</u>	<u>2798</u>	<u>Table, 90-Degree (\$1,533 ea)</u>	<u>3,066</u>
16			20,018

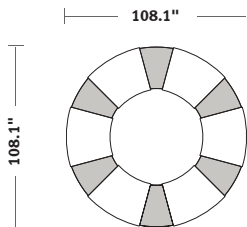

Qty	Model #	Description	COM List
6	2785	Bench, 30-Degree Wedge (\$1,040 ea)	6,240
<u>6</u>	<u>2796</u>	<u>Table, 30-Degree Narrow (\$1,183 ea)</u>	<u>7,098</u>
12			13,338

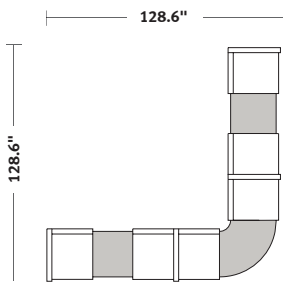

Qty	Model #	Description	COM List
3	2772	Lounge Chair, Right Arm, Straight (\$1,416 ea)	4,248
2	2792	Table, 22" Straight (\$1,234 ea)	2,468
2	2771	Lounge Chair, Armless, Straight (\$1,209 ea)	2,418
1	2798	Table, 90-Degree, Outside Wedge	1,533
<u>1</u>	<u>2773</u>	<u>Lounge Chair, Left Arm, Straight</u>	<u>1,416</u>
9			12,083

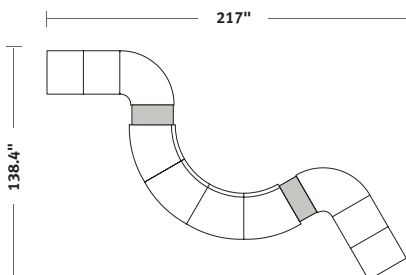

Qty	Model #	Description	COM List
4	2780	Bench, Straight (\$980 ea)	3,920
2	2786	Bench, 90-Degree (\$1,151 ea)	2,302
2	2791	Table, 12" Straight (\$1,014 ea)	2,028
<u>4</u>	<u>2761</u>	<u>Lounge Chair, Armless, 30-Degree Outside Wedge (\$1,313 ea)</u>	<u>5,252</u>
12			13,502

ACHELLA MODULAR

designed by christopher panichella



UPHOLSTERY COMBINATIONS:

For fabric, vinyl or leather upholstery combinations, refer to the pricing below:

- When combining **two** COM/COV/COL fabrics, or fabrics with the same grade, add \$65 List per unit.
- When combining **three or more** COM/COV/COL fabrics, or fabrics with the same grade, add \$75 List per unit.
- When combining different grades of fabric, price will be based on the highest grade specified.
- Two-tone upholstery examples and yardage requirements for the most common combinations are listed below. Additional combinations available, please contact Customer Service for yardage requirements and pricing.
- Note: Yardage amounts are based on fabric which is plain (i.e. non-directional) and a full 54" wide.
- **Appropriate upholstery code must be included on order.**

SIN #711-16

CONFIGURATION EXAMPLES

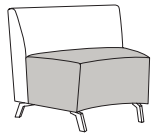

Code AM1

Model COM Requirement
2751 Seat Cushion Only = 1¹/₂ yds.
Balance of Chair = 2¹/₄ yds.

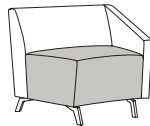

Code AM2

Model COM Requirement
2752 Seat Cushion Only = 1¹/₂ yds.
2753 Balance of Chair = 3 yds.

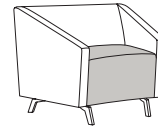

Code AM3

Model COM Requirement
2754 Seat Cushion Only = 1¹/₂ yds.
Balance of Chair = 4 yds.

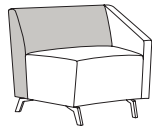

Code AM4

Model COM Requirement
2752 Inside/Outside Back = 1³/₄ yds.
2753 Balance of Chair = 2³/₄ yds.

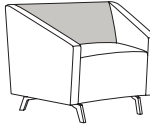

Code AM5

Model COM Requirement
2754 Inside/Outside Back = 1³/₄ yds.
Balance of Chair = 3³/₄ yds.

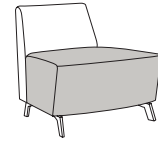

Code AM6

Model COM Requirement
2761 Seat Cushion Only = 1³/₄ yds.
Balance of Chair = 1¹/₂ yds.

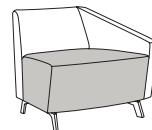

Code AM7

Model COM Requirement
2762 Seat Cushion Only = 1³/₄ yds.
2763 Balance of Chair = 2¹/₂ yds.

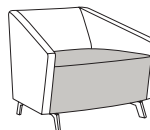

Code AM8

Model COM Requirement
2764 Seat Cushion Only = 1³/₄ yds.
Balance of Chair = 3¹/₂ yds.

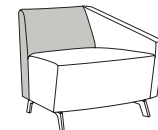

Code AM9

Model COM Requirement
2762 Inside/Outside Back = 1¹/₂ yds.
2763 Balance of Chair = 2³/₄ yds.

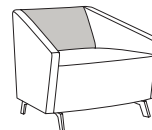

Code AM10

Model COM Requirement
2764 Inside/Outside Back = 1¹/₂ yds.
Balance of Chair = 3³/₄ yds.



Code AM11

Model COM Requirement
2771 Seat Cushion Only = 1¹/₂ yds.
Balance of Chair = 1³/₄ yds.

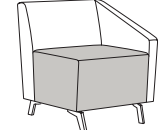

Code AM12

Model COM Requirement
2772 Seat Cushion Only = 1¹/₂ yds.
2773 Balance of Chair = 3 yds.

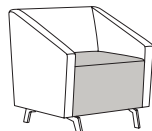

Code AM13

Model COM Requirement
2774 Seat Cushion Only = 1¹/₄ yds.
Balance of Chair = 4¹/₂ yds.

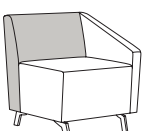

Code AM14

Model COM Requirement
2772 Inside/Outside Back = 1¹/₂ yds.
2773 Balance of Chair = 2³/₄ yds.

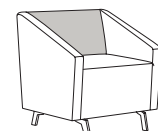

Code AM15

Model COM Requirement
2774 Inside/Outside Back = 1¹/₂ yds.
Balance of Chair = 3¹/₂ yds.

UPHOLSTERY COMBINATIONS:

For fabric, vinyl or leather upholstery combinations, refer to the pricing below:

- When combining **two** COM/COV/COL fabrics, or fabrics with the same grade, add \$65 List per unit.
- When combining **three or more** COM/COV/COL fabrics, or fabrics with the same grade, add \$75 List per unit.
- When combining different grades of fabric, price will be based on the highest grade specified.

- Two-tone upholstery examples and yardage requirements for the most common combinations are listed below. Additional combinations available, please contact Customer Service for yardage requirements and pricing.
- Note: Yardage amounts are based on fabric which is plain (i.e. non-directional) and a full 54" wide.
- **Appropriate upholstery code must be included on order.**

ACHELLA MODULAR

designed by christopher panichella



SIN #711-16

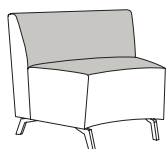

Code AM16

Model COM Requirement
2751 Inside Back/Top of Seat = 1¹/₂ yds.
Balance of Chair = 1³/₄ yds.

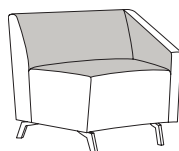

Code AM17

Model COM Requirement
2752 Inside Back/Top of Seat/
2753 Inside Arm = 2¹/₄ yds.
Balance of Chair = 2¹/₄ yds.

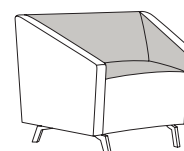

Code AM18

Model COM Requirement
2754 Inside Back/Top of Seat/
Inside Arm = 2³/₄ yds.
Balance of Chair = 2¹/₂ yds.

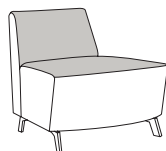

Code AM19

Model COM Requirement
2761 Inside Back/Top of Seat = 1¹/₂ yds.
Balance of Chair = 1³/₄ yds.

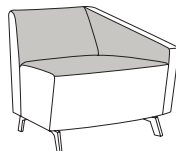

Code AM20

Model COM Requirement
2762 Inside Back/Top of Seat/
2763 Inside Arm = 2 yds.
Balance of Chair = 2 yds.

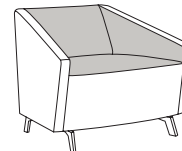

Code AM21

Model COM Requirement
2764 Inside Back/Top of Seat/
Inside Arm = 2¹/₂ yds.
Balance of Chair = 2¹/₂ yds.

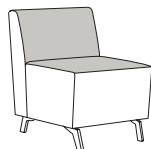

Code AM22

Model COM Requirement
2771 Inside Back/Top of Seat = 1 yd.
Balance of Chair = 1³/₄ yds.

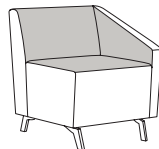

Code AM23

Model COM Requirement
2772 Inside Back/Top of Seat/
2773 Inside Arm = 1¹/₂ yds.
Balance of Chair = 1³/₄ yds.

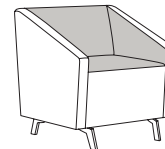

Code AM24

Model COM Requirement
2774 Inside Back/Top of Seat/
Inside Arm = 2 yds.
Balance of Chair = 2¹/₄ yds.

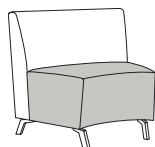

Code AH1

Model COM Requirement
2751-H Seat Cushion Only = 1¹/₂ yds.
2751-HV Balance of Chair = 2¹/₄ yds.

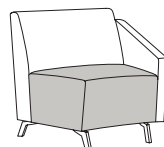

Code AH2

Model COM Requirement
2752-H Seat Cushion Only = 1¹/₂ yds.
2752-HV Balance of Chair = 3¹/₂ yds.
2753-H
2753-HV

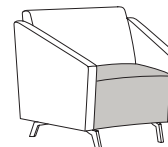

Code AH3

Model COM Requirement
2754-H Seat Cushion Only = 1¹/₂ yds.
2754-HV Balance of Chair = 4¹/₂ yds.

ACHELLA MODULAR

designed by christopher panichella



UPHOLSTERY COMBINATIONS:

For fabric, vinyl or leather upholstery combinations, refer to the pricing below:

- When combining **two** COM/COV/COL fabrics, or fabrics with the same grade, add \$65 List per unit.
- When combining **three or more** COM/COV/COL fabrics, or fabrics with the same grade, add \$75 List per unit.
- When combining different grades of fabric, price will be based on the highest grade specified.
- Two-tone upholstery examples and yardage requirements for the most common combinations are listed below. Additional combinations available, please contact Customer Service for yardage requirements and pricing.
- Note: Yardage amounts are based on fabric which is plain (i.e. non-directional) and a full 54" wide.
- **Appropriate upholstery code must be included on order.**

SIN #711-16

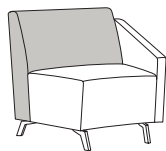

Code AH4
Model COM Requirement
 2752-H Inside/Outside Back = 2¹/₄ yds.
 2752-HV Balance of Chair = 2³/₄ yds.
 2753-H
 2753-HV

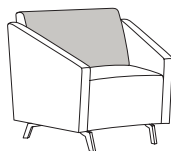

Code AH5
Model COM Requirement
 2754-H Inside/Outside Back = 2¹/₄ yds.
 2754-HV Balance of Chair = 4 yds.

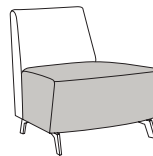

Code AH6
Model COM Requirement
 2761-H Seat Cushion Only = 1³/₄ yds.
 2761-HV Balance of Chair = 1³/₄ yds.

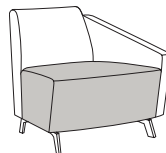

Code AH7
Model COM Requirement
 2762-H Seat Cushion Only = 1³/₄ yds.
 2762-HV Balance of Chair = 2³/₄ yds.
 2763-H
 2763-HV

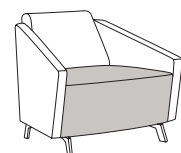

Code AH8
Model COM Requirement
 2764-H Seat Cushion Only = 1³/₄ yds.
 2764-HV Balance of Chair = 4 yds.

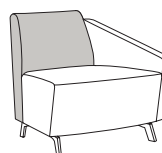

Code AH9
Model COM Requirement
 2762-H Inside/Outside Back = 1³/₄ yds.
 2762-HV Balance of Chair = 2³/₄ yds.
 2763-H
 2763-HV

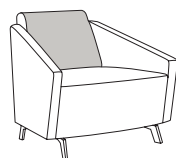

Code AH10
Model COM Requirement
 2764-H Inside/Outside Back = 1³/₄ yds.
 2764-HV Balance of Chair = 3³/₄ yds.

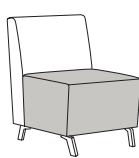

Code AH11
Model COM Requirement
 2771-H Seat Cushion Only = 1¹/₄ yds.
 2771-HV Balance of Chair = 1³/₄ yds.

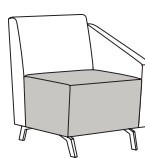

Code AH12
Model COM Requirement
 2772-H Seat Cushion Only = 1¹/₂ yds.
 2772-HV Balance of Chair = 3 yds.
 2773-H
 2773-HV

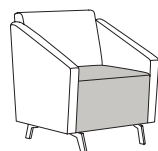

Code AH13
Model COM Requirement
 2774-H Seat Cushion Only = 1¹/₂ yds.
 2774-HV Balance of Chair = 4 yds.

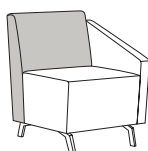

Code AH14
Model COM Requirement
 2772-H Inside/Outside Back = 1³/₄ yds.
 2772-HV Balance of Chair = 2¹/₂ yds.
 2773-H
 2773-HV

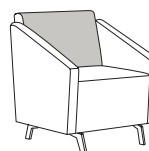

Code AH15
Model COM Requirement
 2774-H Inside/Outside Back = 1³/₄ yds.
 2774-HV Balance of Chair = 3³/₄ yds.

UPHOLSTERY COMBINATIONS:

For fabric, vinyl or leather upholstery combinations, refer to the pricing below:

- When combining **two** COM/COV/COL fabrics, or fabrics with the same grade, add \$65 List per unit.
- When combining **three or more** COM/COV/COL fabrics, or fabrics with the same grade, add \$75 List per unit.
- When combining different grades of fabric, price will be based on the highest grade specified.

- Two-tone upholstery examples and yardage requirements for the most common combinations are listed below. Additional combinations available, please contact Customer Service for yardage requirements and pricing.
- Note: Yardage amounts are based on fabric which is plain (i.e. non-directional) and a full 54" wide.
- **Appropriate upholstery code must be included on order.**

ACHELLA MODULAR

designed by christopher panichella



SIN #711-16

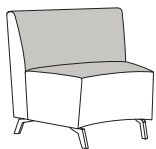

Code AH16
Model COM Requirement
2751-H Inside Back/Top of Seat = 1³/₄ yds.
2751-HV Balance of Chair = 2 yds.

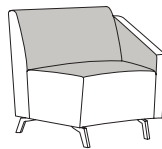

Code AH17
Model COM Requirement
2752-H Inside Back/Top of Seat/
2752-HV Inside Arm = 2¹/₂ yds.
2753-H Balance of Chair = 2³/₄ yds.
2753-HV

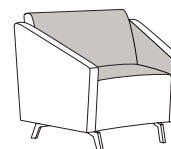

Code AH18
Model COM Requirement
2754-H Inside Back/Top of Seat/
2754-HV Inside Arm = 3¹/₄ yds.
Balance of Chair = 3¹/₂ yds.

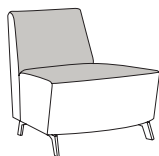

Code AH19
Model COM Requirement
2761-H Inside Back/Top of Seat = 1³/₄ yds.
2761-HV Balance of Chair = 2 yds.

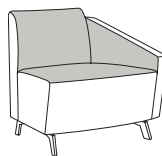

Code AH20
Model COM Requirement
2762-H Inside Back/Top of Seat/
2762-HV Inside Arm = 2¹/₄ yds.
2763-H Balance of Chair = 2¹/₂ yds.
2763-HV

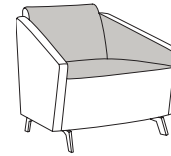

Code AH21
Model COM Requirement
2764-H Inside Back/Top of Seat/
2764-HV Inside Arm = 2³/₄ yds.
Balance of Chair = 3¹/₄ yds.



Code AH22
Model COM Requirement
2771-H Inside Back/Top of Seat = 1 yd.
2771-HV Balance of Chair = 1³/₄ yds.

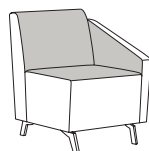

Code AH23
Model COM Requirement
2772 Inside Back/Top of Seat/
2773 Inside Arm = 1¹/₂ yds.
Balance of Chair = 2¹/₄ yds.

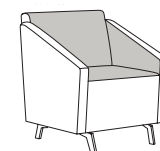

Code AH24
Model COM Requirement
2774-H Inside Back/Top of Seat/
2774-HV Inside Arm = 2 yds.
Balance of Chair = 3¹/₄ yds.

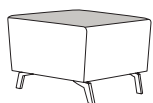

Code AM25
Model COM Requirement
2780 Top of Seat = 1 yd.
Balance of Seat = 1 yd.



Code AM26
Model COM Requirement
2785 Top of Seat = 1 yd.
Balance of Seat = 1¹/₂ yd.

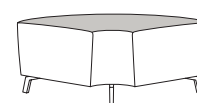

Code AM27
Model COM Requirement
2786 Top of Seat = 1 yd.
Balance of Seat = 1¹/₂ yd.



ACHELLA

OCCASIONAL TABLES

designed by christopher panichella

SIN #711-11

PRODUCT FEATURES:

- Tables manufactured in Maple.
- Custom sizes available, contact Customer Service for pricing.
- All tables feature veneer tops as standard. Laminate and Corian tops available.
- For standard laminates, refer to Standard Finish Card.
- For custom laminates, add \$500 List per color per order. Pre-approval required, please contact Customer Service.
- For Corian top, specify "-CO" next to model number. Corian top is affixed to table top surface increasing overall table height by 1/2". Please note that a 1/8" reveal will be present.
- Corian top available in four standard colors. For non-standard colors, please contact Customer Service for pricing.
- **Table with laminate or Corian top, finish selection for table body must be specified.**
- All standard wood finishes available on Maple.
- For custom wood finishes, please add one-time upcharge of \$400 List per color per order.
- 5" high cast aluminum leg offered in three fixed leg finishes: #90 Metallic Silver, #92 Polished Aluminum and #95 Satin Black.
- All dimensions are nominal.

CORIAN® COLORS:

Designer White
Linen
Rain Cloud
Witch Hazel

Corian® is a registered trademark of Dupont.

ACHELLA OCCASIONAL TABLES

designed by christopher panichella



NOTES:

- Tables manufactured in Maple.
- All tables feature veneer tops as standard. Laminate and Corian tops available.
- For Corian top, specify “-CO” next to model number.
- **Table with laminate or Corian top, finish selection for table body must be specified.**
- 5" high cast aluminum leg offered in #90 Metallic Silver, #92 Polished Aluminum and #95 Satin Black.



SPECIFY:

1. Model number
2. Top finish
3. Body finish
4. Leg finish

ORDERING EXAMPLE:

#325-1818-CO
18" Round Table
Corian Top

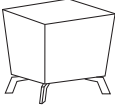
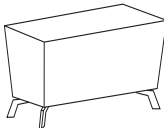
SIN #711-11

MODEL NUMBER		PRODUCT SPECIFICATIONS		TABLE TOP FINISH				
		MODEL NUMBER	VENEER OR LAMINATE	CORIAN (-CO)	WEIGHT			
320  	Achella Square/Rectangle Table 320 Series	320-181818	1270	1646	53			
		320-222220	1384	2043	87			
		320-303018	1649	2675	107			
		320-363618	1906	3600	115			
		320-424218	2070	4371	135			
		320-484818	2359	5360	151			
		320-482218	1859	3058	113			
		325 	Achella Round Table 325 Series	325-1818	1291	1666	40	
				325-2220	1488	2147	46	
325-3018	1760			2787	53			
325-3618	2132			3828	60			
325-4218	2414			4718	72			
325-4818	2796			5801	80			

NOTES:

- Compound curve back and seat shell with upholstered panel arm and fixed back height.
- Synchro-tilt mechanism with pneumatic lift as standard.
- Two base options: Black Nylon or #92 Polished Aluminum.
- Dual wheel carpet casters suitable for carpet and hard surfaces.
- Maximum weight capacity is 300 lbs.

SPECIFY:

1. Model number
2. Upholstery selection
3. Base selection

ORDERING EXAMPLE:



#1696
High Back
Polished Aluminum Base

ADJOURN EXECUTIVE

designed by manuel g. vesa



SIN #711-18

MODEL NUMBER	PRODUCT SPECIFICATIONS	BASE FINISH	FABRIC GRADES							LEATHER GRADES				
			COM	1	2	COL			4	5	6	7	8	L1
1686 	Mid-Back Synchro-Tilt W 25 ¹ / ₂ D 25 ¹ / ₂ H 37 ¹ / ₄ -40 ¹ / ₄ Seat Height 17 ¹ / ₂ Inside Seat Width 20 Inside Seat Depth 19 ¹ / ₂ Arm Height 25 ¹ / ₂ -28 ¹ / ₂ 2 ¹ / ₄ Yds. 49 lbs. COL 45 Sq. Ft. TB 133, add \$108 List	Black Nylon	1384	1512	1543	1597	1651	1703	1758	1807	1862	2110	2292	2469
		Polished Aluminum	1467	1595	1626	1680	1734	1786	1841	1890	1945	2193	2375	2552
1696 	High Back Synchro-Tilt W 25 ¹ / ₂ D 25 ¹ / ₂ H 44 ¹ / ₂ -47 ¹ / ₂ Seat Height 17 ¹ / ₂ Inside Seat Width 20 Inside Seat Depth 19 ¹ / ₂ Arm Height 25 ¹ / ₂ -28 ¹ / ₂ 2 ¹ / ₂ Yds. 52 lbs. COL 50 Sq. Ft. TB 133, add \$120 List	Black Nylon	1495	1637	1671	1732	1792	1850	1910	1965	2026	2301	2503	2700
		Polished Aluminum	1578	1720	1754	1815	1875	1933	1993	2048	2109	2384	2586	2783

NOTES:

- Three wood species available: Maple, Walnut and White Oak in all standard and custom wood finishes.
- For custom wood finishes please add one-time upcharge of \$400 List per color per order.
- Horizontal wood grain pattern standard.
- Metal frame available in #06 Charcoal Grey, #90 Metallic Silver and #91 Chrome.
- Maximum weight capacity is 350 lbs. for 48" wide benches and 700 lbs. for 60" wide benches.

SPECIFY:

1. Model number
2. Wood species
3. Wood finish
4. Frame finish
5. Upholstery selection
6. Options, as applicable

ORDERING EXAMPLE:

#5620-C-GD02
 48" Bench
 Chrome Frame
 Felt Glides

**ALOFT
 BENCHES**

designed by qdesign

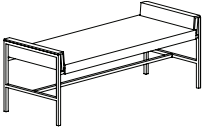
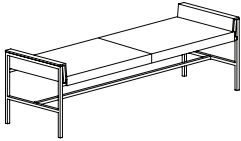

SIN #711-16

MODEL NUMBER	PRODUCT SPECIFICATIONS	FRAME FINISH	FABRIC GRADES							LEATHER GRADES				
			COM	1	2	COL			4	5	6	7	8	L1
5620-P (POWDERCOAT FRAME) 5620-C (CHROME FRAME) 	48" x 20¹/₂" x 20¹/₄" 1 ¹ / ₂ Yds. 70 lbs. Seat Height 18 COL 30 Sq. Ft. TB 133 add \$72 List	Powdercoat	1462	1548	1568	1604	1640	1675	1711	1744	1781	1946	2067	2185
		Chrome	1609	1695	1715	1751	1787	1822	1858	1891	1928	2093	2214	2332
5625-P (POWDERCOAT FRAME) 5625-C (CHROME FRAME) 	60" x 20¹/₂" x 20¹/₄" 2 Yds. 87 lbs. Seat Height 18 COL 40 Sq. Ft. TB 133 add \$96 List	Powdercoat	1560	1674	1701	1749	1798	1844	1892	1936	1985	2205	2367	2524
		Chrome	1683	1797	1824	1872	1921	1967	2015	2059	2108	2328	2490	2647

OPTIONS (XXXX - REFERS TO BENCH MODEL NUMBER)

MODEL	DESCRIPTION	LIST
XXXX-GD02	Felt Glides (For Hard-Surface Flooring)	20

ALOFT BENCHES

designed by qdesign



SIN #711-16

UPHOLSTERY COMBINATIONS:

For fabric vinyl or leather upholstery combinations refer to the pricing below:

- When combining **two** COM/COV/COL fabrics or fabrics with the same grade price will be \$65 List (per unit).
- When combining **three or more** COM/COV/COL fabrics or fabrics with the same grade price will be \$75 List (per unit).
- When combining different grades of fabric price will be based on the highest grade specified.
- Two-tone upholstery examples and yardage requirements for the most common combinations are listed below. Additional combinations available please contact Customer Service for yardage requirements and pricing.
- Note: Yardage amounts are based on fabric which is plain (i.e. non-directional) and a full 54" wide.
- **Appropriate upholstery code must be included on order.**

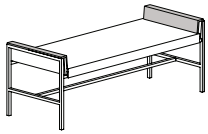

Code AL3

Model COM Requirement
5620 Arm Panels = 1/2 yd.
Balance of Bench = 1 1/4 yds.

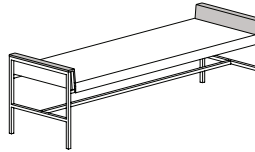

Code AL4

Model COM Requirement
5625 Arm Panels = 1/2 yd.
Balance of Bench = 2 yds.

NOTES:

- Available in Maple, Walnut and White Oak, in all standard and custom wood finishes.
- For custom wood finishes, please add one-time upcharge of \$400 List per color per order.
- Horizontal wood grain pattern standard.
- Metal frame available in #91 Chrome, #06 Charcoal Grey and #90 Metallic Silver.
- Maximum weight capacity is 350 lbs. for lounge chairs and 700 lbs. for love seats.

SPECIFY:

1. Model number
2. Wood species
3. Wood finish
4. Metal frame finish
5. Upholstery selection
6. Options, as applicable

ORDERING EXAMPLE:

#5602-C-GD02

Love Seat, Chrome Frame
Felt Glides

**ALOFT
LOUNGE**

designed by qdesign

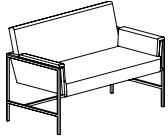

SIN #711-16

MODEL NUMBER	PRODUCT SPECIFICATIONS	FRAME FINISH	FABRIC GRADES							LEATHER GRADES				
			COM	1	2	COL			4	5	6	7	8	L1
5601-P (POWDERCOAT FRAME) 5601-C (CHROME FRAME) 	Lounge Chair W 29 D 26 H 32 Seat Height 17 ³ / ₄ Inside Seat Width 23 ¹ / ₄ Inside Seat Depth 20 Arm Height 24 2 ¹ / ₄ Yds. 59 lbs. COL 45 Sq. Ft. TB 133, add \$108 List	Powdercoat	1861	1989	2020	2074	2128	2180	2235	2284	2339	2587	2769	2946
		Chrome	1995	2123	2154	2208	2262	2314	2369	2418	2473	2721	2903	3080
5602-P (POWDERCOAT FRAME) 5602-C (CHROME FRAME) 	Love Seat W 49 ¹ / ₂ D 26 H 32 Seat Height 17 ³ / ₄ Inside Seat Width 43 ¹ / ₂ Inside Seat Depth 20 Arm Height 24 3 ¹ / ₄ Yds. 79 lbs. COL 65 Sq. Ft. TB 133, add \$156 List	Powdercoat	2516	2701	2745	2824	2902	2977	3056	3127	3206	3564	3827	4083
		Chrome	2679	2864	2908	2987	3065	3140	3219	3290	3369	3727	3990	4246

OPTIONS (XXXX - REFERS TO CHAIR MODEL NUMBER)

MODEL	DESCRIPTION	LIST
XXXX-GD02	Felt Glides	20

ALOFT LOUNGE

designed by qdesign



UPHOLSTERY COMBINATIONS:

For fabric, vinyl or leather upholstery combinations, refer to the pricing below:

- When combining **two** COM/COV/COL fabrics, or fabrics with the same grade, add the following (per unit):
 - > \$65 List for lounge chairs
 - > \$105 List for love seats
- When combining **three or more** COM/COV/COL fabrics, or fabrics with the same grade, add the following (per unit):
 - > \$75 List for lounge chairs
 - > \$115 List for love seats
- When combining different grades of fabric, price will be based on the highest grade specified.
- Two-tone upholstery examples and yardage requirements for the most common combinations are listed below. Additional combinations available, please contact Customer Service for yardage requirements and pricing.
- Note: Yardage amounts are based on fabric which is plain (i.e. non-directional) and a full 54" wide.
- **Appropriate upholstery code must be included on order.**

SIN #711-16

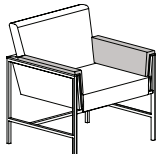

Code AL1
Model COM Requirement
 5601 Arm Panels = 1 yd.
 Balance of Chair = 1³/₄ yds.

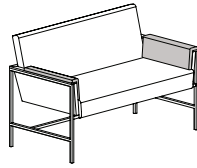

Code AL2
Model COM Requirement
 5602 Arm Panels = 1 yd.
 Balance of Love Seat = 2¹/₂ yds.

NOTES:

- Tables manufactured in Maple, Walnut and White Oak.
- All standard and custom wood finishes available.
- For custom wood finishes, please add \$400 List per color per order.
- Glass top is 1/2" clear glass with eased edge.
- Table tray measures 2" between glass and wood shelf.
- Metal frame available in #06 Charcoal Grey, #90 Metallic Silver and #91 Chrome.

SPECIFY:

1. Model number
2. Wood species
3. Wood finish
4. Frame finish

ORDERING EXAMPLE:

#560-242420
24" Square Table

ALOFT
OCCASIONAL TABLES

designed by qdesign

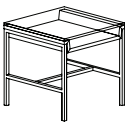
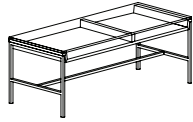

SIN #711-11

MODEL NUMBER	PRODUCT SPECIFICATIONS	FRAME FINISH			WEIGHT
		MODEL NUMBER	POWDERCOAT FRAME	CHROME FRAME	
<p>560</p>  	<p>Aloft Table 560 Series</p>	560-181818	1162	1239	30
		560-242420	1342	1461	35
		560-303018	1731	1847	42
		560-482018	1826	1914	75

AVELINA MEETING TABLES

designed by ramsey madsen
and jim contoio



SIN #711-11

PRODUCT FEATURES:

- Available in two heights: 29" and 42".
- Depth options include: 20", 30", 36" and 42".
- Length sizes include: 60", 72", 96", 120", 144" and 192".
- Tables offered in veneer, laminate and Formica Colorcore® 2.
- Corian top also available.
- Tables with 20" depth are intended for use against a wall or divider (signature edge detail featured on one side only).
- Table lengths of 120" and greater will require a center panel base.
- All panel bases feature adjustable glides as standard for leveling purposes.
- End panel bases, center panel bases and underside of tables feature removable panels for wire management accessibility.
- Select technology options for top surface and/or side-mount placement available on all sizes, please refer to pages 6-10 for options. Power units cannot be installed on center panel bases.
- Two-tone wood finishing available (exterior surface one color, interior surface another color), please add \$300 list for 1-piece tops and \$600 List for 2-piece tops and specify finishes. Edge finish will be the interior surface color.
- All dimensions are nominal.

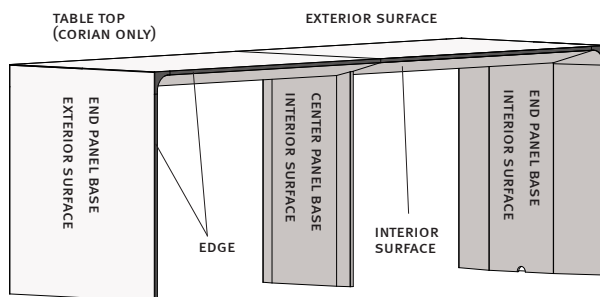

VENEER TABLE FEATURES:

- Available in Maple, Walnut and White Oak wood species.
- Veneer direction will run cross-grain on all table sizes.
- All standard wood finishes available on selected wood species (note: #26 Ebony Maple not available).
- For custom wood finishes, please add one-time upcharge of \$400 List per color per order.

LAMINATE TABLE FEATURES:

- Applied to entire exterior surface only (cannot be used in combination with veneer exterior end panel bases).
- **Wood species and finish must be specified for the table interior surface, which will also be applied to the edge. For the best results, please reference the next page which identifies the appropriate wood species for each standard laminate.**
- Laminate wood grain direction will run lengthwise on all table sizes.
- Available in all standard laminates.
- Matching wood edges and/or bases specified with Formica Brite White and Pionite Slate, please add one-time upcharge of \$400 List per color, per order.
- Matching wood edges and/or bases to our standard wood grain laminates is performed at no additional upcharge.
- For custom laminates, add \$500 List per color per order. Pre-approval required, please contact Customer Service.

AVELINA MEETING TABLES

designed by ramsey madsen
and jim contoia



SIN #711-11

STANDARD LAMINATES AND CORRESPONDING WOOD SPECIES:



Nevamar WM-8-340T
Clear Maple



Pionite WM951-SD
Honey Maple



Nevamar WM-0005T
Siren Maple



Pionite WX421-PV
Witchcraft



Formica 459-58
Brite White



Pionite SG228-SD
Slate

MAPLE



Wilsonart 7937-38
River Cherry



Wilsonart 7039-78
Windsor Mahogany



Pionite WY031-SD
Formal Mahogany



Wilsonart 7935K-07
Shaker Cherry



Wilsonart 7122K-07
Empire Mahogany

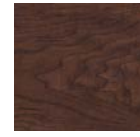

Formica 7739-58
Cocoa Maple

WALNUT



Wilsonart 7954-38
Natural Rift



Pionite WY160-SD
Absolute Acajou



Nevamar WM-0047T
Iconic Maple



Pionite SW101-AW
Black Ashwood



Wilsonart 1595-60
Black

WHITE OAK



AVELINA MEETING TABLES

designed by ramsey madsen
and jim contoio

SIN #711-11

FORMICA COLORCORE® 2 FEATURES:

- Features the same high performance characteristics as laminates with the added dimension of solid through color (i.e. eliminates the dark line associated with laminate edges).
- Offered in 949C-58 White Matte color only.
- Applied to entire exterior surface only (cannot be used in combination with veneer exterior end panel bases).
- Wood species and finish must be specified for the table interior surface, which will also be applied to the edge.
- To order in Colorcore 2, please specify and add \$312 list for 1-piece tops and \$520 List for 2-piece tops (add upcharge to applicable interior surface wood species column).

CORIAN® TOP FEATURES:

- Corian is affixed to table top only and increases overall table height by $\frac{1}{2}$ ". Please note that a $\frac{1}{8}$ " reveal will be present.
- Corian not available on table edges or on panel bases.
- Wood species and finish must be specified for panel bases.
- For Corian top, specify "-CO" after model number with color selection and add upcharge to applicable table pricing.
- Custom Corian colors available, please contact Customer Service for pricing.

CORIAN® COLORS:

Designer White
Linen
Rain Cloud
Witch Hazel

Corian® is a registered trademark of Dupont.

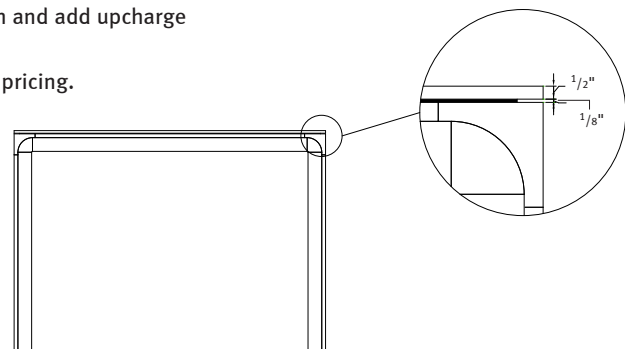

SHIPPING/ASSEMBLY:

- **All tables ship blanket-wrap.**
- If cartoning is required, a 5% upcharge will be applied to each applicable product. Contact Customer Service for additional information.
- Tables 96" in length and under ship in one piece.
- Tables 120" in length and over ship in two sections.
- All tables that are shipped in more than one piece will include a table joint connector to attach sections together.
- Limited field assembly is required as bases are pre-assembled to table tops.

AVELINA MEETING TABLES

designed by ramsey madsen
and jim contoio



SIN #711-11

NOTES:

- 20" depth tables are intended for use against a wall or divider.
- Table lengths of 120" and greater will include a center panel base.
- For Corian top, specify "-CO" after model number with color selection and add upcharge to applicable table pricing.
- When ordering laminate, Colorcore 2 or Corian, interior surface wood species and finish must be specified.
- Refer to page 1 for Colorcore 2 and two-tone finishing upcharges.

SPECIFY:

1. Model number
2. Wood species
3. Exterior surface finish
4. Interior surface finish, as applicable
5. Options, as applicable

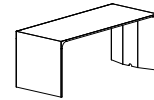

REPRESENTS 60", 72" AND 96" TABLE LENGTHS, WITH 29" OR 42" HEIGHTS

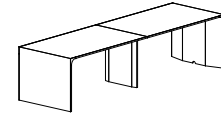

REPRESENTS 120", 144" AND 192" TABLE LENGTHS, WITH 29" OR 42" HEIGHTS (INCLUDES CENTER PANEL BASE)

	MODEL NUMBER	MAPLE OR LAMINATE EXTERIOR WITH MAPLE INTERIOR	WALNUT, WHITE OAK OR LAMINATE EXTERIOR WITH WALNUT OR WHITE OAK INTERIOR	CORIAN TOP (-CO) Add upcharge to applicable wood species column	WEIGHT For veneer, laminate and Colorcore 2 tables only
20" Depth, 29" Height					
20 D x 60 L x 29 H	A-206029	4951	5581	1304	142
20 D x 72 L x 29 H	A-207229	5246	5911	1564	151
20 D x 96 L x 29 H	A-209629	5563	6269	2085	165
20 D x 120 L x 29 H	A-2012029	7011	7499	2606	256
20 D x 144 L x 29 H	A-2014429	7282	7832	3126	269
20 D x 192 L x 29 H	A-2019229	8071	8721	4168	289
20" Depth, 42" Height					
20 D x 60 L x 42 H	A-206042	5150	5802	1304	153
20 D x 72 L x 42 H	A-207242	5443	6115	1564	163
20 D x 96 L x 42 H	A-209642	5764	6501	2085	177
20 D x 120 L x 42 H	A-2012042	7452	8081	2606	287
20 D x 144 L x 42 H	A-2014442	7883	8549	3126	301
20 D x 192 L x 42 H	A-2019242	8397	9278	4168	321
30" Depth, 29" Height					
30 D x 60 L x 29 H	A-306029	5580	6257	1953	156
30 D x 72 L x 29 H	A-307229	5943	6659	2345	169
30 D x 96 L x 29 H	A-309629	6260	6988	3126	183
30 D x 120 L x 29 H	A-3012029	8657	9504	3909	280
30 D x 144 L x 29 H	A-3014429	9058	9984	4689	198
30 D x 192 L x 29 H	A-3019229	9725	10700	6251	318
30" Depth, 42" Height					
30 D x 60 L x 42 H	A-306042	6313	7107	1953	193
30 D x 72 L x 42 H	A-307242	6685	7506	2345	205
30 D x 96 L x 42 H	A-309642	7110	7962	3126	221
30 D x 120 L x 42 H	A-3012042	9322	10259	3909	347
30 D x 144 L x 42 H	A-3014442	9696	10716	4689	364
30 D x 192 L x 42 H	A-3019242	10433	11518	6251	388

NOTES:

- Table lengths of 120" and greater will include a center panel base.
- For Corian top, specify "-CO" after model number with color selection and add upcharge to applicable table pricing.
- When ordering laminate, Colorcore 2 or Corian, interior surface wood species and finish must be specified.
- Refer to page 1 for Colorcore 2 and two-tone finishing upcharges.

SPECIFY:

1. Model number
2. Wood species
3. Exterior surface finish
4. Interior surface finish, as applicable
5. Options, as applicable

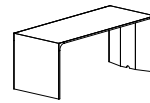

REPRESENTS 60", 72" AND 96" TABLE LENGTHS, WITH 29" OR 42" HEIGHTS

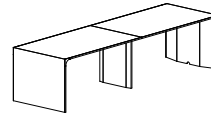

REPRESENTS 120", 144" AND 192" TABLE LENGTHS, WITH 29" OR 42" HEIGHTS (INCLUDES CENTER PANEL BASE)

AVELINA MEETING TABLES

designed by ramsey madsen and jim contoia



SIN #711-11

	MODEL NUMBER	MAPLE OR LAMINATE EXTERIOR WITH MAPLE INTERIOR	WALNUT, WHITE OAK OR LAMINATE EXTERIOR WITH WALNUT OR WHITE OAK INTERIOR	CORIAN TOP (-CO) Add upcharge to applicable wood species column	WEIGHT For veneer, laminate and Colorcore 2 tables only
36" Depth, 29" Height					
36 D x 60 L x 29 H	A-366029	6143	6876	2693	176
36 D x 72 L x 29 H	A-367229	6505	7265	3231	188
36 D x 96 L x 29 H	A-369629	6941	7732	4308	204
36 D x 120 L x 29 H	A-3612029	9348	10343	5384	315
36 D x 144 L x 29 H	A-3614429	9848	10891	6460	332
36 D x 192 L x 29 H	A-3619229	10570	11672	8614	356
36" Depth, 42" Height					
36 D x 60 L x 42 H	A-366042	6456	7242	2693	193
36 D x 72 L x 42 H	A-367242	6803	7633	3231	205
36 D x 96 L x 42 H	A-369642	7230	8080	4308	222
36 D x 120 L x 42 H	A-3612042	10133	11250	5384	357
36 D x 144 L x 42 H	A-3614442	10628	11787	6460	373
36 D x 192 L x 42 H	A-3619242	11256	12378	8614	398
42" Depth, 29" Height					
42 D x 60 L x 29 H	A-426029	6409	7169	3148	184
42 D x 72 L x 29 H	A-427229	6775	7580	3770	196
42 D x 96 L x 29 H	A-429629	7124	7948	5026	210
42 D x 120 L x 29 H	A-4212029	10097	11204	6282	334
42 D x 144 L x 29 H	A-4214429	10692	11855	7537	352
42 D x 192 L x 29 H	A-4219229	11502	12747	10049	371
42" Depth, 42" Height					
42 D x 60 L x 42 H	A-426042	6705	7544	3148	201
42 D x 72 L x 42 H	A-427242	7068	7935	3770	214
42 D x 96 L x 42 H	A-429642	7475	8361	5026	230
42 D x 120 L x 42 H	A-4212042	10962	12199	6282	377
42 D x 144 L x 42 H	A-4214442	11438	12826	7537	395
42 D x 192 L x 42 H	A-4219242	12374	13770	10049	418

AVELINA MEETING TABLES



designed by ramsey madsen
and jim contoio



SIN #711-11

NOTES:

- All units below are corded and available for top surface and/or side-mount placement. Refer to pages 8-9 for daisy chain options.
- Power units cannot be positioned above center panel bases nor can they be installed onto center panel bases themselves.
- Side-mount placement can be on inside or outside of end panel bases.
- **Please specify if power unit is to be placed on table top, inside base panel or outside base panel.**
- Cord length should be taken into account when specifying electrical placement.
- **Power source location must be identified.**
- Refer to page 11 for power unit standard locations.
- End interior panel bases, center panel bases and underside of tables feature removable panels for wire management accessibility.
- To add power cord exit to the exterior base panel, please specify -"PC02" and add \$75 List. For 20" depth tables, please note the base location as left or right, as facing.

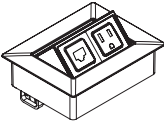
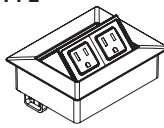
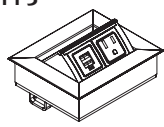
MODEL #	PRODUCT SPECIFICATIONS	LIST
<p>PB1-S (SILVER FINISH) PB1-W (WHITE FINISH)</p> 	<p>Power Band 1</p> <ul style="list-style-type: none"> ▪ Dimensions: 5³/₄" W x 2¹/₂" D ▪ Metallic Silver or White finish ▪ One (1) outlet and two (2) USB charging ports ▪ 108" electrical cord (only length available) ▪ UL Listed 	413
<p>PB2-S (SILVER FINISH) PB2-W (WHITE FINISH)</p> 	<p>Power Band 2</p> <ul style="list-style-type: none"> ▪ Dimensions: 5³/₄" W x 2¹/₂" D ▪ Metallic Silver or White finish ▪ Two (2) outlets ▪ 108" electrical cord (only length available) ▪ UL Listed 	322
<p>PB3-S (SILVER FINISH) PB3-W (WHITE FINISH)</p> 	<p>Power Band 3</p> <ul style="list-style-type: none"> ▪ Dimensions: 6¹/₂" W x 2¹/₂" D ▪ Metallic Silver or White finish ▪ Two (2) outlets and two (2) USB charging ports ▪ 108" electrical cord (only length available) ▪ UL Listed 	429
<p>PP1</p> 	<p>Portal Power 1</p> <ul style="list-style-type: none"> ▪ Dimensions: 5¹/₄" W x 4¹/₄" D ▪ Touch latch lid with Satin Nickel finish ▪ Unit features one simplex outlet with 72" electrical cord and one RJ-45 jack (Cat 6) with 72" patch cable ▪ 120" length cord available, please specify and add \$30 List ▪ UL listed 	612
<p>PP2</p> 	<p>Portal Power 2</p> <ul style="list-style-type: none"> ▪ Dimensions: 5¹/₄" W x 4¹/₄" D ▪ Touch latch lid with Satin Nickel finish ▪ Unit features two simplex outlets with 72" electrical cord ▪ 120" length cord available, please specify and add \$30 List ▪ UL listed 	542
<p>PP3</p> 	<p>Portal Power 3</p> <ul style="list-style-type: none"> ▪ Dimensions: 5¹/₄" W x 4¹/₄" D ▪ Touch latch lid with Satin Nickel finish ▪ Unit features one simplex outlet with 72" electrical cord and dual USB charging ports ▪ 120" length cord available, please specify and add \$30 List ▪ UL listed 	643

NOTES:

- All units below are corded and available for top surface placement only. Refer to pages 8-9 for daisy chain options.
- Power units cannot be positioned above center panel bases.
- Cord length should be taken into account when specifying electrical placement.
- **Power source location must be identified.**
- End interior panel bases, center panel bases and underside of tables feature removable panels for wire management accessibility.
- To add power cord exit to the exterior base panel, please specify -"PC02" and add \$75 List. For 20" depth tables, please note the base location as left or right, as facing.
- For the following technology units, please reference A/V jack combination options below. The price of individual A/V jacks must be added to the Base Model unit price listed below.
- Please contact Customer Service for faceplate/jack combinations that may not be referenced herein.
- Select units show open port positions which, once A/V jacks are purchased, can be reconfigured with different A/V jacks as needed.
- A/V jacks and faceplates snap into opening(s) in metal housing of Base Model units.

AVELINA MEETING TABLES

designed by ramsey madsen
and jim contoio



SIN #711-11

MODEL #	PRODUCT SPECIFICATIONS	LIST
PP4	<p>Portal Power 4</p> <ul style="list-style-type: none"> ▪ Dimensions: 8⁵/₁₆" W x 4¹/₄" D ▪ Touch latch lid with clear anodized aluminum finish ▪ Two (2) 15 amp simplex outlets and two (2) open ports ▪ 72" electrical cord, no A/V jacks included ▪ 120" length cord available, please specify and add \$30 List ▪ UL Listed 	575
PP6	<p>Portal Power 6</p> <ul style="list-style-type: none"> ▪ Dimensions: 9¹³/₁₆" W x 4¹/₄" D ▪ Touch latch lid with clear anodized aluminum finish ▪ Three (3) 15 amp simplex outlets and three (3) open ports ▪ 72" electrical cord, no A/V jacks included ▪ 120" length cord available, please specify and add \$30 List ▪ UL Listed 	612
PP7	<p>Portal Power 7</p> <ul style="list-style-type: none"> ▪ Dimensions: 6³/₄" W x 4³/₈" D ▪ Touch latch lid with clear anodized aluminum finish ▪ Two (2) 15 amp simplex outlets and two (2) USB charging ports ▪ 72" electrical cord ▪ 120" length cord available, please specify and add \$30 List ▪ UL Listed <p>PP4, PP6 and PP7 units available for top surface mount placement only.</p>	665

FACEPLATE CONFIGURATION OPTIONS

ID#	PART #	A/V JACK DESCRIPTION(S)	LIST
1)	Q1	(1) RJ-45 (Cat 5e), punchdown	\$33
2)	Q2	(1) RJ-45 (Cat 6), male/female pre-terminated, 72" long	\$87
3)	Q3	(1) RJ-45 (Cat 6), male/female pre-terminated, 120" long	\$87
4)	Q4	15 pin HD VGA with male/female cable, 72" long	\$87
5)	Q5	15 pin HD VGA with male/female cable, 120" long	\$102
6)	Q6	3.5mm Mini-Stereo jack with male/female cable, 120" long	\$33
7)	Q9	HDMI Corded Coupler, 18" long	\$82

Refer to page 10 for power unit standard locations.

AVELINA MEETING TABLES

designed by ramsey madsen and jim contoio



SIN #711-11

NOTES:

- All units below are corded and available for top surface placement only. Refer to pages 8-9 for daisy chain options.
- Power units cannot be positioned above center panel bases.
- Cord length should be taken into account when specifying electrical placement.
- **Power source location must be identified.**
- End interior panel bases, center panel bases and underside of tables feature removable panels for wire management accessibility.
- To add power cord exit to the exterior base panel, please specify -"PC02" and add \$75 List. For 20" depth tables, please note the base location as left or right, as facing.
- For the following technology units, please reference A/V jack combination options below. The price of individual A/V jacks must be added to the Base Model unit price listed below.
- Please contact Customer Service for faceplate/jack combinations that may not be referenced herein.
- Select units show open port positions which, once A/V jacks are purchased, can be reconfigured with different A/V jacks as needed.
- A/V jacks and faceplates snap into opening(s) in metal housing of Base Model units.

MODEL # PRODUCT SPECIFICATIONS LIST

AP4

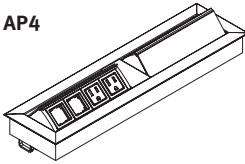

Alternate Portal 4

- Dimensions: 16¹/₂" W x 4¹/₂" D
- Touch latch lid with clear anodized aluminum finish
- Four (4) 15 amp simplex outlets and four (4) open ports
- 72" electrical cord, no A/V jacks included
- 120" length cord available, please specify and add \$30 List
- UL Listed

1136

LP4

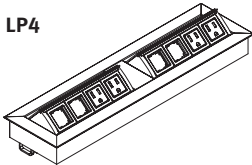

Linear Portal

- Dimensions: 16¹/₂" W x 4¹/₂" D
- Touch latch lid with clear anodized aluminum finish
- Four (4) 15 amp simplex outlets and four (4) open ports
- 72" electrical cord, no A/V jacks included
- 120" length cord available, please specify and add \$30 List
- UL Listed

1136

AP4 and LP4 power units available for top surface mount placement only.

FACEPLATE CONFIGURATION OPTIONS

ID#	PART #	A/V JACK DESCRIPTION(S)	LIST
1)	Q1	(1) RJ-45 (Cat 5e), punchdown	\$33
2)	Q2	(1) RJ-45 (Cat 6), male/female pre-terminated, 72" long	\$87
3)	Q3	(1) RJ-45 (Cat 6), male/female pre-terminated, 120" long	\$87
4)	Q4	15 pin HD VGA with male/female cable, 72" long	\$87
5)	Q5	15 pin HD VGA with male/female cable, 120" long	\$102
6)	Q6	3.5mm Mini-Stereo jack with male/female cable, 120" long	\$33
7)	Q9	HDMI Corded Coupler, 18" long	\$82

Refer to page 10 for power unit standard locations.



NOTES:

- Daisy chain units are required when more than one electrical unit is specified on one top.
- To determine jumper cable length, measure length from edge of electrical unit to end of table.
- Every connection point must be a female-to-male or male-to-female connection (all daisy chain power units feature male ends).

AVELINA MEETING TABLES

designed by ramsey madsen
and jim contoio

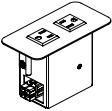
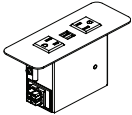
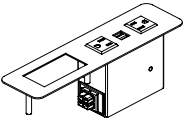
SIN #711-11

MODEL NUMBER	PRODUCT SPECIFICATIONS	LIST												
POWER BANDS WITH DAISY CHAIN FEATURE MALE ENDS														
PB2-DC-S (SILVER FINISH) PB2-DC-W (WHITE FINISH) 	Power Band 2 Daisy Chain <ul style="list-style-type: none"> ▪ Dimensions: 5³/₄" W x 2¹/₂" D ▪ Metallic Silver or White finish ▪ Unit features two simplex outlets ▪ UL listed 	442												
PB3-DC-S (SILVER FINISH) PB3-DC-W (WHITE FINISH) 	Power Band 3 Daisy Chain <ul style="list-style-type: none"> ▪ Dimensions: 6¹/₂" W x 2¹/₂" D ▪ Metallic Silver or White finish ▪ Unit features two simplex outlets and two USB charging ports ▪ UL listed 	546												
PB4-DC-S (SILVER FINISH) PB4-DC-W (WHITE FINISH) 	Power Band 4 Daisy Chain <ul style="list-style-type: none"> ▪ Dimensions: 10¹/₂" W x 2¹/₂" D ▪ Metallic Silver or White finish ▪ Unit features two simplex outlets, two USB charging ports and cut-out for an A/V faceplate ▪ For available A/V faceplate options, please refer to Power/Data Technology price list ▪ UL Listed 	578												
PB-ST-CD-72 	Power Band Starter Cable, 72" Long, Corded Plug Infeed <ul style="list-style-type: none"> ▪ Must select either corded or hardwire starter cable which goes from power source in wall or floor to first Power Band Unit 	208												
PB-ST-HW-() 	Power Band Starter Cable, Hardwire Infeed <ul style="list-style-type: none"> ▪ Must select either corded or hardwire starter cable which goes from power source in wall or floor to first Power Band Unit <table border="1"> <thead> <tr> <th>MODEL</th> <th>LENGTH</th> <th>LIST</th> </tr> </thead> <tbody> <tr> <td>PB-ST-HW-72</td> <td>72"</td> <td>141</td> </tr> <tr> <td>PB-ST-HW-108</td> <td>108"</td> <td>177</td> </tr> <tr> <td>PB-ST-HW-120</td> <td>120"</td> <td>188</td> </tr> </tbody> </table>	MODEL	LENGTH	LIST	PB-ST-HW-72	72"	141	PB-ST-HW-108	108"	177	PB-ST-HW-120	120"	188	
MODEL	LENGTH	LIST												
PB-ST-HW-72	72"	141												
PB-ST-HW-108	108"	177												
PB-ST-HW-120	120"	188												

AVELINA MEETING TABLES

designed by ramsey madsen
and jim contoio

NOTES:

- Daisy chain units are required when more than one electrical unit is specified on one top.
- To determine jumper cable length, measure length from edge of electrical unit to end of table.
- Every connection point must be a female-to-male or male-to-female connection (all daisy chain power units feature male ends).

SIN #711-11

MODEL NUMBER PRODUCT SPECIFICATIONS LIST

PB-FF(-)



Power Band Jumper Cables, Female to Female

- Typically used to connect 2 units together
- For additional lengths in 12" increments, please add \$20 List per foot

MODEL	LENGTH	LIST
PB-FF-30	30"	120
PB-FF-36	36"	120
PB-FF-48	48"	130
PB-FF-54	54"	136
PB-FF-60	60"	141
PB-FF-72	72"	151

PB-FM(-)



Power Band Jumper Cables, Female to Male

- Typically used to connect 2 units together
- For additional lengths in 12" increments, please add \$20 List per foot

MODEL	LENGTH	LIST
PB-FM-30	30"	125
PB-FM-36	36"	125
PB-FM-48	48"	136
PB-FM-54	54"	141
PB-FM-60	60"	146
PB-FM-72	72"	156

PB-T



Power Band T-Connector

- Used when power is needed to go in two directions
- Features 2 male ends and 1 female end

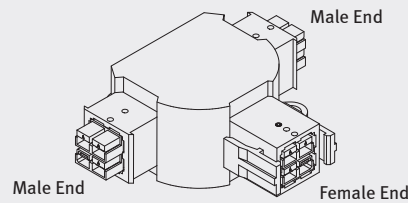

162

AVELINA MEETING TABLES

designed by ramsey madsen
and jim contoio



SIN #711-11

POWER UNIT STANDARD LOCATIONS

Table Top Positioning

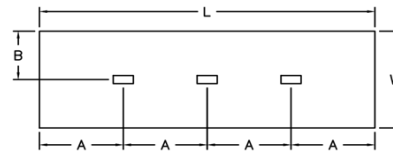
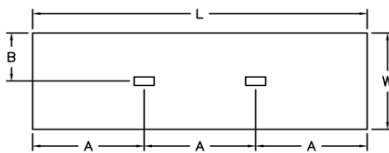

Side Panel (inside & outside)

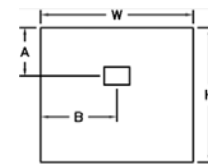

2 Power Units

W X L	A	B
20" x 60"	20"	5"
20" x 72"	24"	5"
20" x 96"	32"	5"
20" x 120"	40"	5"
20" x 144"	48"	5"
20" x 192"	64"	5"
30" x 60"	20"	15"
30" x 72"	24"	15"
30" x 96"	32"	15"
30" x 120"	40"	15"
30" x 144"	48"	15"
30" x 192"	64"	15"
36" x 60"	20"	18"
36" x 72"	24"	18"
36" x 96"	32"	18"
36" x 120"	40"	18"
36" x 144"	48"	18"
36" x 192"	64"	18"
42" x 60"	20"	21"
42" x 72"	24"	21"
42" x 96"	32"	21"
42" x 120"	40"	21"
42" x 144"	48"	21"
42" x 192"	64"	21"

3 Power Units

W X L	A	B
20" x 60"	15"	5"
20" x 72"	18"	5"
20" x 96"	24"	5"
30" x 60"	15"	15"
30" x 72"	18"	15"
30" x 96"	24"	15"
36" x 60"	15"	18"
36" x 72"	18"	18"
36" x 96"	24"	18"
42" x 60"	15"	21"
42" x 72"	18"	21"
42" x 96"	24"	21"

1 Power Unit

W X L	A	B
20" x 29"	10.25"	5"
30" x 29"	10.25"	15"
36" x 29"	10.25"	18"
42" x 29"	10.25"	21"
20" x 42"	10.25"	5"
30" x 42"	10.25"	15"
36" x 42"	10.25"	18"
42" x 42"	10.25"	21"

For custom power unit placement, please contact Customer Service to verify location can be accommodated.

AVESA BENCHES

designed by manuel g. vesa



SIN #711-16

PRODUCT FEATURES:

- Fixed legs available in four finishes: #90 Metallic Silver, #91 Chrome, #95 Satin Black and Beech wood.
- For wood fixed legs, please specify “-WL01” after model number with finish selection and add \$110 List per unit.
- Tables manufactured in Beech.
- Dimensions: 22" W x 19³/₄" D x 16" H.
- Two table surface options: Beech veneer or laminate.
- All standard and custom wood finishes available on Beech.
- For custom wood finishes (to tables, wood legs and/or rotating tablet), please add one-time upcharge of \$400 List per color per order.
- For standard laminates, refer to Standard Finish Card.
- For custom laminates, add \$500 List per color per order. Pre-approval required, please contact Customer Service.
- Non-skid glides available for hard surface floors. Please specify “-NS06B” after model number and add \$20 List per unit.
- Maximum weight capacity is 400 lbs. for single seat benches, 800 lbs. for two-seat models and 1200 lbs. for three-seat units.
- All dimensions are nominal.

POWER BAND UNITS:

- For placement on tables only.
- PB1 and PB2 dimensions: 5³/₄" W x 2¹/₂" D
- PB3 dimensions: 6¹/₂" W x 2¹/₂" D
- Metallic Silver or White finish with 108" electrical cord.
- UL listed.



PB1

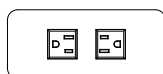

PB2



PB3

- PB1 unit features one outlet and two USB charging ports.
- PB2 unit features two outlets.
- PB3 unit features two outlets and two USB charging ports.

AVESA BENCHES

designed by manuel g. vesa



SIN #711-16

NOTES:

- Fixed legs available in four finishes: #90 Metallic Silver, #91 Chrome, #95 Satin Black and Beech wood.
- For wood fixed legs, add \$110 List per unit and specify finish.
- Center table manufactured in Beech.
- Two table surface options: Beech veneer or laminate.
- All standard and custom wood finishes available on Beech.

SPECIFY:

1. Model number
2. Leg finish
3. Upholstery selection
4. Options, as applicable

ORDERING EXAMPLE:

#7302-CT-NS06B

Two-Seat Bench, Center Table
Non-Skid Glides

MODEL NUMBER	PRODUCT SPECIFICATIONS	FABRIC GRADES							LEATHER GRADES				
		COM	1	2	COL			8	L1	L2	L3		
7301	Single Seat Bench W 22 ¹ / ₂ D 22 ¹ / ₂ H 17 ¹ / ₂ 1 ¹ / ₂ Yds. 27 lbs. COL 30 Sq. Ft. TB 133, add \$72 List	958	1044	1064	1100	1136	1171	1207	1240	1277	1442	1563	1681
7302	Two-Seat Bench W 45 D 22 ¹ / ₂ H 17 ¹ / ₂ 3 Yds. 54 lbs. COL 60 Sq. Ft. TB 133, add \$144 List	1644	1815	1856	1928	2000	2070	2142	2208	2281	2612	2854	3090
7302-CT	Two-Seat Bench with Center Table W 67 D 22 ¹ / ₂ H 17 ¹ / ₂ 3 Yds. 84 lbs. COL 60 Sq. Ft. TB 133, add \$144 List	2490	2661	2702	2774	2846	2916	2988	3054	3127	3458	3700	3936
7303	Three-Seat Bench W 68 D 22 ¹ / ₂ H 17 ¹ / ₂ 4 ¹ / ₂ Yds. 81 lbs. COL 90 Sq. Ft. TB 133, add \$216 List	2239	2495	2556	2665	2773	2877	2986	3085	3194	3690	4054	4408

OPTIONS (XXXX - REFERS TO BENCH MODEL NUMBER)

MODEL	DESCRIPTION	LIST
XXXX-PB1-S	Power Band 1 (one power, two USB), Silver	413
XXXX-PB1-W	Power Band 1 (one power, two USB), White	413
XXXX-PB2-S	Power Band 2 (dual power), Silver	322
XXXX-PB2-W	Power Band 2 (dual power), White	322
XXXX-PB3-S	Power Band 3 (dual power, two USB), Silver	429
XXXX-PB3-W	Power Band 3 (dual power, two USB), White	429
XXXX-NS06B	Non-Skid Glides	20

AVESA MODULAR

designed by manuel g. vesa



SIN #711-16

LOUNGE PRODUCT FEATURES:

- Two back options: sculpted wood or fully upholstered.
- Fixed leg dimensions: 1³/₄" Dia. x 6" H.
- Four fixed leg finish options: #90 Metallic Silver, #91 Chrome, #95 Satin Black or Beech wood.
- For wood fixed legs, please specify "-WL01" after model number and add \$110 List per unit.
- All standard and custom wood finishes available on Beech.
- For custom wood finishes (to legs or tables), please add one-time upcharge of \$400 List per color per order.
- Non-skid glides available for hard surface floors. Please specify "-NS06B" after model number and add \$20 List per unit.
- Maximum weight capacity is 350 lbs. per seat. Bariatric model accommodates up to 750 lbs. per seat.
- Please refer to page 8 for two-tone upholstery examples, yardage requirements and pricing.
- All dimensions are nominal.

IN-LINE AND END TABLE PRODUCT FEATURES:

- Available in three sizes: 10" wide straight, 22" wide straight and quarter-round.
- Three table surface options: Beech veneer, laminate or Corian.
- All standard and custom wood finishes available on Beech.
- For custom wood finishes (to legs or tables), please add one-time upcharge of \$400 List per color per order.
- For standard laminates, refer to Standard Finish Card.
- For custom laminates, add \$500 List per color per order. Pre-approval required, please contact Customer Service.
- Corian top is 1/2" thick in lieu of standard table top thickness of 3/4".
- Corian top available in seven standard colors. For non-standard colors, please contact Customer Service for pricing.
- **Table with laminate or Corian top, finish selection for table body must be specified.**
- All dimensions are nominal.

CORIAN® COLORS:

Designer White
Linen
Rain Cloud
Witch Hazel

Corian® is a registered trademark of Dupont.

BENCH PRODUCT FEATURES:

- Available in two sizes: 22" wide straight and quarter-round.
- Benches available individually or in modular combinations with lounge units and tables.
- Maximum weight capacity is 400 lbs. per bench seat.
- **Note: Upholstery direction must be specified on quarter-round benches when patterned fabrics are selected. In the absence of specific instructions, Arcadia reserves the right to upholster units at our discretion.**

Up the roll

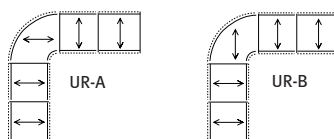

Railroaded

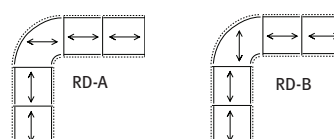

AVESA MODULAR

designed by manuel g. vesa



SIN #711-16

MODULAR ARRANGEMENTS:

- For modular configurations, lounge units, tables and/or benches are connected with dual steel beams.
- Leg placement determined by modular configuration. Please contact Customer Service if exact positioning is required.
- Assembly required.
- **Note: Please include layout drawings or sketch with each order.**
- **Note: Arcadia reserves the right to pre-assemble units at the factory to simplify shipping and installation requirements.**

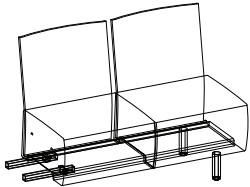

POWER UNITS:

- Available on all tables.
- Unit will be positioned in the center of tables as standard, unless otherwise specified.
- PB1 and PB2 dimensions: 5³/₄" W x 2¹/₂" D
- PB3 dimensions: 6¹/₂" W x 2¹/₂" D
- Metallic Silver or White finish with 108" electrical cord.
- UL listed.



PB1

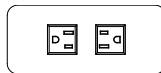

PB2

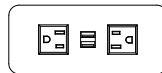

PB3

- PB1 unit features one outlet and two USB charging ports.
- PB2 unit features two outlets.
- PB3 unit features two outlets and two USB charging ports.

NOTES:

- Sculpted Beech wood back available in all standard and custom finishes.
- Fixed legs available in #90 Metallic Silver, #91 Chrome, #95 Satin Black and Beech wood.
- For wood fixed legs, add \$110 List per unit and specify finish.
- Refer to page 8 for two-tone upholstery examples and yardage requirements.
- For connecting tables and bench models, refer to pages 5-7.

SPECIFY:

1. Model number
2. Wood finish
3. Leg finish
4. Upholstery selection
5. Options, as applicable

Please include layout drawings or sketch with each order.

ORDERING EXAMPLE:

#5001-R-NS06B

Sculpted Wood Back Lounge
Right End Unit
Non-Skid Glides

**AVESA
MODULAR**

designed by manuel g. vesa



SIN #711-16

MODEL NUMBER	PRODUCT SPECIFICATIONS	FABRIC GRADES								LEATHER GRADES			
		COM	1	2	COL			6	7	8	L1	L2	L3
5001-R	Modular Lounge Unit Sculpted Wood Back Right End Unit (as seated) W 22 D 26 H 33 Seat Height 17 ¹ / ₂ Inside Seat Width 22 ¹ / ₂ Inside Seat Depth 19 ³ / ₄ 1 ¹ / ₂ Yds. 34 lbs. COL 30 Sq. Ft. TB 133, add \$72 List	1239	1325	1345	1381	1417	1452	1488	1521	1558	1723	1844	1962
5001-L	Modular Lounge Unit Sculpted Wood Back Left End Unit (as seated) W 22 D 26 H 33 Seat Height 17 ¹ / ₂ Inside Seat Width 22 ¹ / ₂ Inside Seat Depth 19 ³ / ₄ 1 ¹ / ₂ Yds. 34 lbs. COL 30 Sq. Ft. TB 133, add \$72 List	1239	1325	1345	1381	1417	1452	1488	1521	1558	1723	1844	1962
5001-C	Modular Lounge Unit Sculpted Wood Back In-Line Unit W 22 D 26 H 33 Seat Height 17 ¹ / ₂ Inside Seat Width 22 ¹ / ₂ Inside Seat Depth 19 ³ / ₄ 1 ¹ / ₂ Yds. 34 lbs. COL 30 Sq. Ft. TB 133, add \$72 List	1239	1325	1345	1381	1417	1452	1488	1521	1558	1723	1844	1962

OPTIONS (XXXX - REFERS TO CHAIR MODEL NUMBER)

MODEL	DESCRIPTION	LIST
XXXX-WL01	Wood Legs	110
XXXX-NS06B	Non-Skid Glides	20

AVESA MODULAR

designed by manuel g. vespa



NOTES:

- Fully upholstered seat and back.
- Fixed legs available in #90 Metallic Silver, #91 Chrome, #95 Satin Black and Beech wood.
- For wood fixed legs, add \$110 List per unit and specify finish.
- Refer to page 8 for two-tone upholstery examples and yardage requirements.
- For connecting tables and bench models, refer to pages 5-7.

SPECIFY:

1. Model number
2. Leg finish
3. Upholstery selection
4. Options, as applicable

Please include layout drawings or sketch with each order.

ORDERING EXAMPLE:

#5005-L-NS06B

Fully Upholstered Lounge
Left End Unit
Non-Skid Glides

SIN #711-16

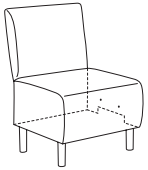
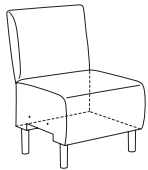
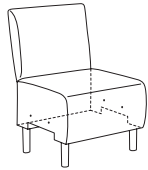
MODEL NUMBER	PRODUCT SPECIFICATIONS	FABRIC GRADES							LEATHER GRADES				
		COM	1	2	COL 3	4	5	6	7	8	L1	L2	L3
5005-R 	Modular Lounge Unit Upholstered Back Right End Unit (as seated) W 22 D 26 H 33 Seat Height 17 ¹ / ₂ Inside Seat Width 22 ¹ / ₂ Inside Seat Depth 19 ³ / ₄ 2 ¹ / ₂ Yds. 39 lbs. COL 50 Sq. Ft. TB 133, add \$120 List	1165	1307	1341	1402	1462	1520	1580	1635	1696	1971	2173	2370
5005-L 	Modular Lounge Unit Upholstered Back Left End Unit (as seated) W 22 D 26 H 33 Seat Height 17 ¹ / ₂ Inside Seat Width 22 ¹ / ₂ Inside Seat Depth 19 ³ / ₄ 2 ¹ / ₂ Yds. 39 lbs. COL 50 Sq. Ft. TB 133, add \$120 List	1165	1307	1341	1402	1462	1520	1580	1635	1696	1971	2173	2370
5005-C 	Modular Lounge Unit Upholstered Back In-Line Unit W 22 D 26 H 33 Seat Height 17 ¹ / ₂ Inside Seat Width 22 ¹ / ₂ Inside Seat Depth 19 ³ / ₄ 2 ¹ / ₂ Yds. 39 lbs. COL 50 Sq. Ft. TB 133, add \$120 List	1165	1307	1341	1402	1462	1520	1580	1635	1696	1971	2173	2370

OPTIONS (XXXX - REFERS TO CHAIR MODEL NUMBER)

MODEL	DESCRIPTION	LIST
XXXX-WL01	Wood Legs	110
XXXX-NS06B	Non-Skid Glides	20

NOTES:

- Available in Beech veneer, laminate or Corian (top surface only).
- Corian top is 1/2" thick in lieu of standard table top thickness of 3/4".
- **Table with laminate or Corian top, finish selection for table body must be specified.**
- Power units will be mounted to the center of tables, unless otherwise specified. Refer to page 2 for details.
- Refer to pages 3-4 for lounge seats and page 7 for modular bench models.

SPECIFY:

1. Model number
2. Wood finish
3. Options, as applicable

Please include layout drawings or sketch with each order.

ORDERING EXAMPLE:

#5010-CO-PB1-S

10" Straight Corian In-Line Table
Power Band 1 Unit, Silver

**AVESA
MODULAR**

designed by manuel g. vesa

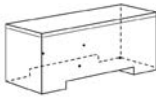
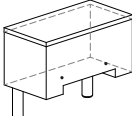
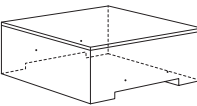
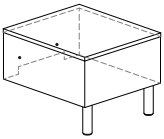

SIN #711-16

MODEL NUMBER	PRODUCT SPECIFICATIONS	TABLE TOP FINISH	
		VENEER OR LAMINATE	CORIAN (-CO)
5010 	10" Straight In-Line Table W 10 D 19 ³ / ₄ H 16 16 lbs.	917	1191
5015 	10" Straight Left/Right Side End Table W 10 D 19 ³ / ₄ H 16 16 lbs.	917	1191
5022 	22" Straight In-Line Table W 22 D 19 ³ / ₄ H 16 32 lbs.	1147	1710
5033 	22" Straight Left/Right Side End Table W 22 D 19 ³ / ₄ H 16 32 lbs.	1147	1710

OPTIONS (XXXX - REFERS TO TABLE MODEL NUMBER)

MODEL	DESCRIPTION	LIST
XXXX-PB1-S	Power Band 1 (one power, two USB), Silver	413
XXXX-PB1-W	Power Band 1 (one power, two USB), White	413
XXXX-PB2-S	Power Band 2 (dual power), Silver	322
XXXX-PB2-W	Power Band 2 (dual power), White	322
XXXX-PB3-S	Power Band 3 (dual power, two USB), Silver	429
XXXX-PB3-W	Power Band 3 (dual power, two USB), White	429

AVESA MODULAR

designed by manuel g. vesa



NOTES:

- Available in Beech veneer, laminate or Corian (top surface only).
- Corian top is 1/2" thick in lieu of standard table top thickness of 3/4".
- **Table with laminate or Corian top, finish selection for table body must be specified.**
- Power units will be mounted to the center of tables, unless otherwise specified. Refer to page 2 for details.
- Refer to pages 3-4 for lounge seats and page 7 for modular bench models.

SPECIFY:

1. Model number
2. Wood finish
3. Leg finish
4. Options, as applicable



Please include layout drawings or sketch with each order.

ORDERING EXAMPLE:

#5045-CO

Corian Quarter-Round Table

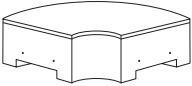
SIN #711-16

MODEL NUMBER	PRODUCT SPECIFICATIONS	TABLE TOP FINISH	
		VENEER OR LAMINATE	CORIAN (-CO)
5045 	Quarter-Round Table W 26 ¹ / ₂ D 26 ¹ / ₂ H 16 37 lbs.	1325	2292
5045-ER 	Quarter-Round End Table, Right (as seated) W 26 ¹ / ₂ D 26 ¹ / ₂ H 16 37 lbs.	1600	2571
5045-EL 	Quarter-Round End Table, Left (as seated) W 26 ¹ / ₂ D 26 ¹ / ₂ H 16 37 lbs.	1600	2571

OPTIONS (XXXX - REFERS TO TABLE MODEL NUMBER)

MODEL	DESCRIPTION	LIST
XXXX-PB1-S	Power Band 1 (one power, two USB), Silver	413
XXXX-PB1-W	Power Band 1 (one power, two USB), White	413
XXXX-PB2-S	Power Band 2 (dual power), Silver	322
XXXX-PB2-W	Power Band 2 (dual power), White	322
XXXX-PB3-S	Power Band 3 (dual power, two USB), Silver	429
XXXX-PB3-W	Power Band 3 (dual power, two USB), White	429
XXXX-NS06A	Non-Skid Glides	10

NOTES:

- Modular bench units available in two sizes: 22" wide straight and quarter-round.
- Fixed legs available in #90 Metallic Silver, #91 Chrome, #95 Satin Black and Beech wood.
- For wood fixed legs, add \$110 List per unit and specify finish.
- Maximum weight capacity is 400 lbs. per bench seat.
- Refer to pages 3-4 for lounge seats and pages 5-6 for modular table models.
- **Note: Please include layout drawings or sketch with each order.**

SPECIFY:

1. Model number
2. Leg finish, as applicable
3. Upholstery selection
4. Options, as applicable

ORDERING EXAMPLE:

#5080-NS06A

Quarter-Round Bench
Non-Skid Glides

AVESA MODULAR

designed by manuel g. vespa



SIN #711-16

MODEL NUMBER	PRODUCT SPECIFICATIONS	FABRIC GRADES								LEATHER GRADES			
		COM	1	2	COL			7	8	L1	L2	L3	
5060	Modular Bench End Unit Right/Left Side W 22 D 22 ^{1/2} H 17 ^{1/2} 1 ^{1/2} Yds. 26 lbs. COL 30 Sq. Ft. TB 133, add \$72 List	958	1044	1064	1100	1136	1171	1207	1240	1277	1442	1563	1681
5070	Modular Bench In-Line Unit W 22 D 22 ^{1/2} H 17 ^{1/2} 1 ^{1/2} Yds. 26 lbs. COL 30 Sq. Ft. TB 133, add \$72 List	958	1044	1064	1100	1136	1171	1207	1240	1277	1442	1563	1681
5080	Modular Quarter-Round Bench W 29 D 29 H 17 ^{1/2} 1 ^{3/4} Yds. 28 lbs. COL 35 Sq. Ft. TB 133, add \$84 List	1065	1165	1189	1231	1273	1314	1356	1394	1437	1630	1771	1909
5080-ER	Modular Quarter-Round Bench, End Right (as facing) W 29 D 29 H 17 ^{1/2} 1 ^{3/4} Yds. 28 lbs. COL 35 Sq. Ft. TB 133, add \$84 List	1065	1165	1189	1231	1273	1314	1356	1394	1437	1630	1771	1909
5080-EL	Modular Quarter-Round Bench, End Left (as facing) W 29 D 29 H 17 ^{1/2} 1 ^{3/4} Yds. 28 lbs. COL 35 Sq. Ft. TB 133, add \$84 List	1065	1165	1189	1231	1273	1314	1356	1394	1437	1630	1771	1909

OPTIONS (XXXX - REFERS TO CHAIR MODEL NUMBER)

MODEL	DESCRIPTION	LIST
XXXX-NS06A	Non-Skid Glides	10

AVESA MODULAR

designed by manuel g. vespa



UPHOLSTERY COMBINATIONS:

For fabric, vinyl or leather upholstery combinations, refer to the pricing below:

- When combining **two** COM/COV/COL fabrics, or fabrics with the same grade, add \$65 List per unit.
 - When combining **three or more** COM/COV/COL fabrics, or fabrics with the same grade, add \$75 List per unit.
 - When combining different grades of fabric, price will be based on the highest grade specified.
- Two-tone upholstery examples and yardage requirements for the most common combinations are listed below. Additional combinations available, please contact Customer Service for yardage requirements and pricing.
 - Note: Yardage amounts are based on fabric which is plain (i.e. non-directional) and a full 54" wide.
 - **Appropriate upholstery code must be included on order.**

SIN #711-16

STANDARD LOUNGE AND BENCH MODELS

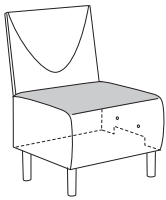

Code AV1

Model COM Requirement
5001's Top of Seat = $\frac{3}{4}$ yd.
 Balance of Seat = 1 yd.

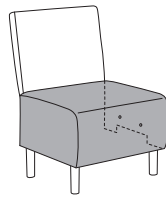

Code AV2

Model COM Requirement
5005's Seat Cushion Only = $1\frac{1}{2}$ yds.
 Balance of Chair = 1 yd.

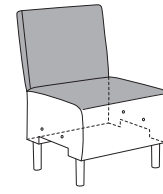

Code AV3

Model COM Requirement
5005's Inside/Outside Back/
 Top of Seat Cushion = $1\frac{3}{4}$ yds.
 Balance of Chair = 1 yd.

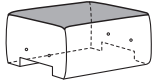

Code AV4

Model COM Requirement
5060 Top of Seat = $\frac{3}{4}$ yd.
5070 Balance of Seat = 1 yd.

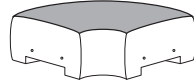

Code AV5

Model COM Requirement
5080 Top of Seat = 1 yd.
 Balance of Seat = $1\frac{1}{4}$ yds.



BRINK STOOLS

designed by andrew gower



SIN #711-18

PRODUCT FEATURES:

- 25" and 30" height models available with or without upholstered seat pad.
- Wood shell available in Beech, Walnut and White Oak, in all standard and custom wood finishes.
- For custom wood finishes, please add one-time upcharge of \$400 List per color per order.
- Metal frame available in standard and premium finishes. See below for options.
- For premium metal finishes, specify "-PF02" after model number, add \$80 List per unit and specify color.
- Footrest is positioned 10" from the floor.
- Glides available for hard-surface floors. Please specify "-GD01" after model number and add \$20 List per unit.
- Maximum weight capacity of 350 lbs.
- All dimensions are nominal.

STANDARD FRAME FINISH COLORS:

#06 Charcoal Grey #91 Chrome
#90 Metallic Silver #95 Satin Black

PREMIUM FRAME FINISH COLORS:

#07 Gold Shimmer #83 Metallic Champagne
#08 Penny #94 Cotton
#09 Brown Sugar

BRINK STOOLS

designed by andrew gower



NOTES:

- Two heights offered.
- Available in Beech, Walnut and White Oak.
- Standard and premium metal frame finishes. Refer to page 1 for options.





SPECIFY:

1. Model number
2. Wood species
3. Wood finish, as applicable
4. Frame finish
5. Upholstery selection, as applicable
6. Options, as applicable

ORDERING EXAMPLE:

#1715-25-GD01
25" Height Stool
Glides

SIN #711-18

MODEL NUMBER	PRODUCT SPECIFICATIONS	FABRIC GRADES						LEATHER GRADES					
		COM	1	2	COL 3	4	5	6	7	8	L1	L2	L3
1710-25 	Q S 25" Height Stool, Wood Seat W 19 D 18 H 32 ¹ / ₂ Seat Height 25 Seat Width 16 ¹ / ₂ Seat Depth 14 ¹ / ₂ 18 lbs.	731											
1715-25 	Q S 25" Height Stool, Upholstered Seat Pad W 19 D 18 H 32 ¹ / ₂ Seat Height 25 ¹ / ₂ Seat Width 16 ¹ / ₂ Seat Depth 14 ¹ / ₂ 3/4 Yd. 19 lbs. COL 15 Sq. Ft. TB 133, add \$35 List	803	846	856	874	892	910	928	944	963	1045	1106	1165
1710-30 	Q S 30" Height Stool, Wood Seat W 19 D 18 H 37 ¹ / ₂ Seat Height 30 Seat Width 16 ¹ / ₂ Seat Depth 14 ¹ / ₂ 20 lbs.	743											
1715-30 	Q S 30" Height Stool, Upholstered Seat Pad W 19 D 18 H 37 ¹ / ₂ Seat Height 30 ¹ / ₂ Seat Width 16 ¹ / ₂ Seat Depth 14 ¹ / ₂ 3/4 Yd. 21 lbs. COL 15 Sq. Ft. TB 133, add \$35 List	813	856	866	884	902	920	938	954	973	1055	1116	1175

OPTIONS (XXXX - REFERS TO STOOL MODEL NUMBER)

MODEL	DESCRIPTION	LIST
XXXX-GD01	Glides (for hard-surface floors)	20
XXXX-PF02	Premium Finish	80

Q S = Available on Quick-Ship Program (Chrome and Metallic Silver frame finish only).

NOTES:

- Available in Beech, Walnut and White Oak, in all standard and custom wood finishes.
- For custom wood finishes, please add one-time upcharge of \$400 List per color per order.
- Footring available in Chrome only and is positioned from the floor as follows:
 - › 7" for 25" height stools
 - › 12" for 30" height stools
- Maximum weight capacity of 250 lbs.

SPECIFY:

1. Model number
2. Wood species
3. Wood finish, as applicable
4. Upholstery selection, as applicable



ORDERING EXAMPLE:

#3330-25
25" Height Stool

CHATTER STOOLS

designed by david dahl

SIN #711-18

MODEL NUMBER	PRODUCT SPECIFICATIONS	FABRIC GRADES										LEATHER GRADES		
		WOOD SPECIES	COL	1	2	3	4	5	6	7	8	L1	L2	L3
3310-25 	25" Height Stool, Wood Seat W 16 ¹ / ₂ D 16 ¹ / ₂ H 31 ¹ / ₂ Seat Height 25 Seat Width 16 ¹ / ₂ Seat Depth 14 ¹ / ₂ 11 lbs.	Beech	846											
		Walnut & White Oak	1220											
3320-25 	25" Height Stool, Upholstered Seat Pad W 16 ¹ / ₂ D 16 ¹ / ₂ H 31 ¹ / ₂ Seat Height 25 ¹ / ₂ Seat Width 16 ¹ / ₂ Seat Depth 14 ¹ / ₂ ³ / ₄ Yd. 12 lbs. COL 15 Sq. Ft. TB 133, add \$35 List	Beech	917	960	970	988	1006	1024	1042	1058	1077	1159	1220	1279
		Walnut & White Oak	1291	1334	1344	1362	1380	1398	1416	1432	1451	1533	1594	1653
3330-25 	25" Height Stool, Upholstered Seat and Back Pads W 16 ¹ / ₂ D 16 ¹ / ₂ H 31 ¹ / ₂ Seat Height 25 ¹ / ₂ Seat Width 16 ¹ / ₂ Seat Depth 14 ¹ / ₂ ³ / ₄ Yd. 12 lbs. COL 15 Sq. Ft. TB 133, add \$35 List	Beech	989	1032	1042	1060	1078	1096	1114	1130	1149	1231	1292	1351
		Walnut & White Oak	1361	1404	1414	1432	1450	1468	1486	1502	1521	1603	1664	1723

Please note all dimensions listed above are nominal.

CHATTER STOOLS

designed by david dahl



NOTES:

- Available in Beech, Walnut and White Oak, in all standard and custom wood finishes.
- For custom wood finishes, please add one-time upcharge of \$400 List per color per order.
- Footring available in Chrome only and is positioned from the floor as follows:
 - > 7" for 25" height stools
 - > 12" for 30" height stools
- Maximum weight capacity of 250 lbs.



SPECIFY:

1. Model number
2. Wood species
3. Wood finish, as applicable
4. Upholstery selection, as applicable

ORDERING EXAMPLE:

#3330-30
30" Height Stool

SIN #711-18

MODEL NUMBER	PRODUCT SPECIFICATIONS	WOOD SPECIES	COM	FABRIC GRADES							LEATHER GRADES						
				1	2	COL			4	5	6	7	8	L1	L2	L3	
3310-30 	30" Height Stool, Wood Seat W 16 ¹ / ₂ D 16 ¹ / ₂ H 36 ¹ / ₂ Seat Height 30 Seat Width 16 ¹ / ₂ Seat Depth 14 ¹ / ₂ 13 lbs.	Beech	857														
		Walnut & White Oak	1231														
3320-30 	30" Height Stool, Upholstered Seat Pad W 16 ¹ / ₂ D 16 ¹ / ₂ H 36 ¹ / ₂ Seat Height 30 ¹ / ₂ Seat Width 16 ¹ / ₂ Seat Depth 14 ¹ / ₂ ³ / ₄ Yd. 14 lbs. COL 15 Sq. Ft. TB 133, add \$35 List	Beech	928	971	981	999	1017	1035	1053	1069	1088	1170	1231	1290			
		Walnut & White Oak	1301	1344	1354	1372	1390	1408	1426	1442	1461	1543	1604	1663			
3330-30 	30" Height Stool, Upholstered Seat and Back Pads W 16 ¹ / ₂ D 16 ¹ / ₂ H 36 ¹ / ₂ Seat Height 30 ¹ / ₂ Seat Width 16 ¹ / ₂ Seat Depth 14 ¹ / ₂ ³ / ₄ Yd. 14 lbs. COL 15 Sq. Ft. TB 133, add \$35 List	Beech	999	1042	1052	1070	1088	1106	1124	1140	1159	1241	1302	1361			
		Walnut & White Oak	1373	1416	1426	1444	1462	1480	1498	1514	1533	1615	1676	1735			

Please note all dimensions listed above are nominal.

CO-OP MEETING SPACES

designed by qdesign



SIN #711-16

GENERAL PRODUCT FEATURES:

- Excluding the back and seat cushions, fabric upholstery will always be railroaded.
- All models standard with 2" high black plinth base only.
- Tables, accent tier and shelf available in Maple, Walnut and White Oak wood species.
- All standard and custom wood finishes available.
- For custom wood finishes (to tables, accent tier and/or shelf), please add one-time upcharge of \$400 List per color per order.
- Laminate available in all Arcadia standard laminates.
- For custom laminates, add \$500 List per color per order. Pre-approval required, please contact Customer Service.
- Unless specified, wood grain direction will run horizontally on accent tier and lengthwise on all tables.
- Table bases and shelf support posts available in standard and premium metal finishes.
- For premium metal finishes, please refer to applicable sections for upcharge amounts.
- When specifying electrical or overhead LED light fixture, cord exit grommet placement must be specified as well as power source location, as applicable. Refer to power units on page 8 for placement specifications.
- **All units with the exception of single modules, 90-degree back models and 3-sided models, must be either floor mounted (hardware provided) or weighted with sandbags (50 lbs. per side for lounge models and 150 lbs. each side for love seat units).**
- **DISCLAIMER: ARCADIA CANNOT BE HELD RESPONSIBLE IF FLOOR MOUNTING OR WEIGHTS ARE NOT UTILIZED FOR INSTALLATION.**
- Please refer to pages 43-54 for multi-tone yardage requirements and applicable pricing.
- Field-assembly required for all seating models with canopy, units with integrated tables and wall-mount panels, as well as linking tables, cantilever tables and shelf.
- Mounting hardware provided for linking tables, cantilever tables and shelf.
- Linking tables, cantilever tables and shelf cannot be retro-fit to seating units previously ordered. Please include layout to ensure units are mounted to the appropriate side of seating models.

INTEGRATED TABLE, FREE-STANDING TABLE, CANTILEVER TABLE AND SHELF EDGE DETAIL:

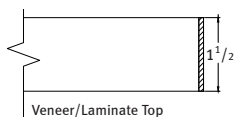

- Table/shelf with veneer top, wood edge finish will match top finish color, unless otherwise specified.
- Table/shelf with Arcadia standard laminate top, self edge is standard, unless otherwise specified (laminate applied to edge).

STANDARD FINISH COLORS (FOR TABLE SUPPORT POST, SHELF POST AND FREE-STANDING TABLE BASE):

- | | |
|-------------------|---------------------|
| #06 Charcoal Grey | #91 Chrome |
| #95 Satin Black | #90 Metallic Silver |

PREMIUM FINISH COLORS (FOR TABLE SUPPORT POST, SHELF POST AND FREE-STANDING TABLE BASE):

- #07 Gold Shimmer
- #08 Penny
- #09 Brown Sugar
- #83 Metallic Champagne
- #94 Cotton

CO-OP MEETING SPACES

designed by qdesign



SIN #711-16

SINGLE MODULE PRODUCT FEATURES:

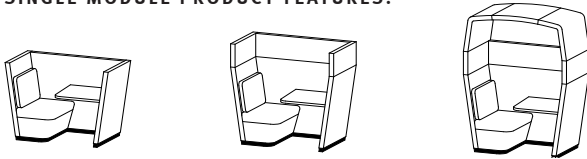

- Public free-standing, private free-standing and private free-standing with full canopy offered.
- Accent tier panel available in upholstery, veneer, laminate or whiteboard material. Refer to Accent Tier product features section (page 5) for information.
- Modules come standard with 27" high integrated table.
- Integrated table available in Maple, Walnut and White Oak veneer, as well as laminate selections.
- Overhead recessed LED swivel light available on full canopy models. Single fixture measures 2⁵/₈" in diameter and draws 3 watts. Features touch-controlled power button next to seat back cushion.
- Power units available on front and side of seating units and on tables. Position must be specified, in addition to cord exit grommet placement and power source location, as applicable.

PUBLIC THREE-SIDED UNIT PRODUCT FEATURES:

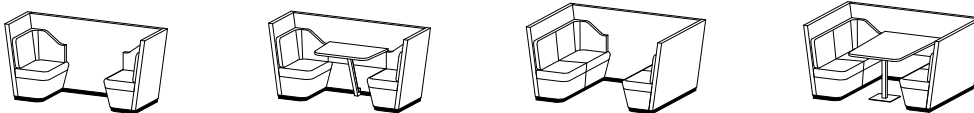

- Lounge and love seat models, measuring 43¹/₂" in height.
- Offered with, and without, 27" high integrated table.
- Integrated table available in Maple, Walnut and White Oak veneer, as well as laminate selections.
- Table support post available in standard and premium metal finishes.
- Power units available on front and side of seating units and on tables. Position must be specified, in addition to cord exit grommet placement and power source location, as applicable.

PRIVATE THREE-SIDED UNIT PRODUCT FEATURES:

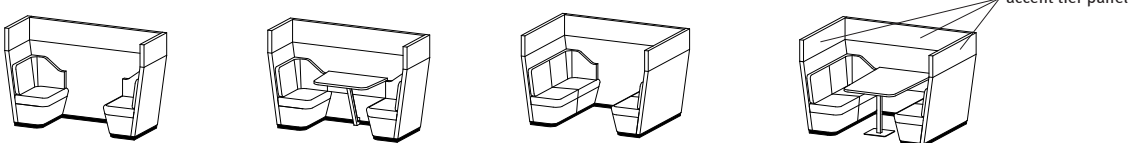

- Single Modules, Lounge and love seat models, measuring 56³/₄" in height.
- Accent tier panel available in upholstery, veneer, laminate or whiteboard material. Refer to Accent Tier product features section (page 5) for information.
- Offered with, and without, 27" high integrated table.
- Integrated table available in Maple, Walnut and White Oak veneer as well as laminate selections.
- Table support post available in standard and premium metal finishes.
- Power units available on front and side of seating units and on tables. Position must be specified, in addition to cord exit grommet placement and power source location, as applicable.
- Monitor-ready mounting option includes a PB5 table-mounted power unit. Monitor and mount not included. Refer to page 8 for standard grommet locations.

CO-OP MEETING SPACES

designed by qdesign



SIN #711-16

PRIVATE THREE-SIDED UNIT WITH CANOPY PRODUCT FEATURES:

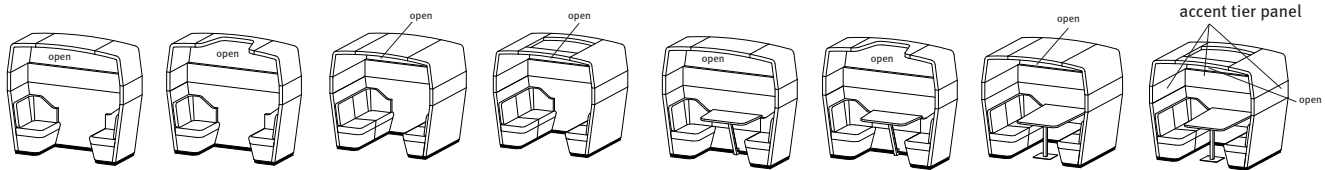

- Lounge and love seat models, measuring 88¹/₂" in height, available with full, partial or open canopy.
- **Note: Canopy not available with polyurethane or vinyl upholstery.**
- Accent tier panel available in upholstery, veneer, laminate or whiteboard material. Refer to Accent Tier product features section (page 5).
- Offered with, and without, 27" high integrated table.
- Integrated table available in Maple, Walnut and White Oak veneer, as well as laminate selections.
- Table support post available in standard and premium metal finishes.
- Overhead recessed LED swivel light available on full canopy models. Measuring 2⁵/₈" in diameter and drawing 3 watts each, lounge units come with one fixture, and love seats come with two fixtures. Features touch-controlled power button on right or left side of seats, please specify location.
- Cantilever table and shelf available on love seat models only. Refer to individual product features section for information.
- Power units available on front and side of seating units and on tables.
- When specifying electrical or overhead LED light fixture, cord exit grommet placement must be specified, as well as power source location, as applicable.
- Optional linking table (to place between two private love seat units) and storage cubby (for use in side-to-side applications) ordered separately. Refer to individual product features section for information.
- Monitor-ready mounting option includes a PB5 table-mounted power unit. Monitor and mount not included. Refer to page 8 for standard grommet locations.

BOOTH PRODUCT FEATURES:

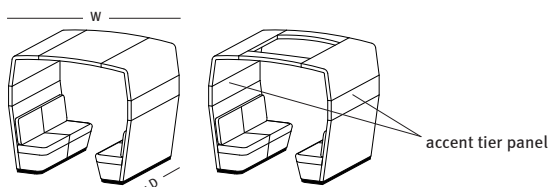

- Available in 60" and 72" depths, measuring 88¹/₂" in height, with full or open canopy.
- **Note: Canopy not available with polyurethane or vinyl upholstery.**
- Accent tier panel available in upholstery, veneer, laminate or whiteboard material. Refer to Accent Tier product features section (page 5).
- Overhead recessed LED swivel light available on full canopy models. Comes with two fixtures, measuring 2⁵/₈" in diameter and drawing 3 watts each. Features touch-controlled power button on right or left side of seats, please specify location.
- Power units available on front and side of seating units.
- When specifying electrical or overhead LED light fixture, cord exit grommet placement must be specified, as well as power source location, as applicable.
- Optional cantilever table and shelf available. Refer to individual product features section for information.
- Optional linking table (to place between two private love seat units) and storage cubby (for use in back-to-back applications) ordered separately. Refer to individual product features section for information.
- Free-standing tables ordered separately.

CO-OP MEETING SPACES

designed by qdesign



SIN #711-16

STAND-ALONE PANEL WITH TABLE PRODUCT FEATURES:

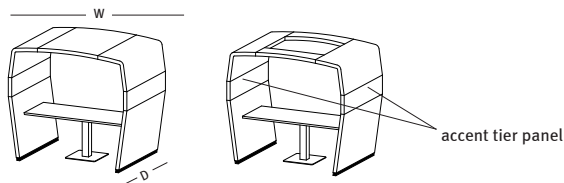

- Available in 60" and 72" depths, measuring 88¹/₂" in height, with full or open canopy.
- **Note: Canopy not available with polyurethane or vinyl upholstery.**
- Accent tier panel available in upholstery, veneer, laminate or whiteboard material. Refer to Accent Tier product features section (page 5).
- Table available at 27", 29" or 39" heights, in varying depths.
- Table available in Maple, Walnut and White Oak veneer, as well as laminate selections.
- Table column dimensions: 4³/₄" x 4³/₄".
- Table base plate dimensions: 22" x 22".
- Table column and base plate available in standard and premium metal finishes.
- Overhead recessed LED swivel light available on full canopy models. Comes with two fixtures, measuring 2⁵/₈" in diameter and drawing 3 watts each. Features touch-controlled power button on right or left side of seats, please specify location.
- Optional cantilever table and shelf available. Refer to individual product features section for information.
- Optional linking table (to place between two private love seat units) and storage cubby (for use in back-to-back applications) ordered separately. Refer to individual product features section for information.
- Optional power units mounted to center of table as standard.
- When specifying electrical or overhead LED light fixture, cord exit grommet placement must be specified, as well as power source location, as applicable.

CO-OP MEETING SPACES

designed by qdesign



SIN #711-16

WALL-MOUNT PANEL PRODUCT FEATURES:

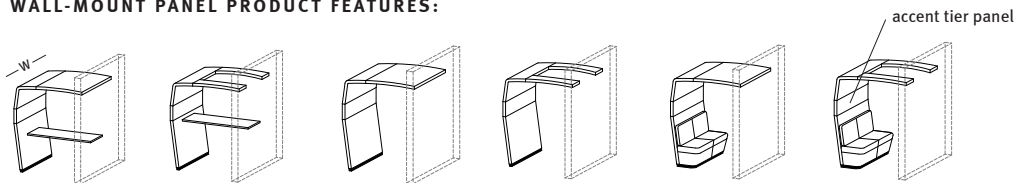

- Available in 60" and 72" widths, measuring 88¹/₂" in height, with full or open canopy.
- Note: Canopy not available with polyurethane or vinyl upholstery.**
- Panel available with suspended table, connected love seat or by itself.
- Panel by itself must be floor-mounted, hardware included.
- Panel with connected love seat must be either floor-mounted or weighted with sandbags. Hardware included for floor-mounting. Optional sandbags can be ordered separately.
- Suspended table available at 27", 29" or 39" heights, in varying depths.
- Accent tier panel available in upholstery, veneer, laminate or whiteboard material. Refer to Accent Tier product features below.
- Overhead recessed LED swivel light available on panel with suspended table or panel with love seat. Comes with two fixtures, measuring 2⁵/₈" in diameter and drawing 3 watts each. Features touch-controlled power button on right or left side of seat/table, please specify location.
- Optional cantilever table and shelf available. Refer to individual product features section for information.
- Optional linking table (to place between two private love seat units) and storage cubby (for use in back-to-back applications) ordered separately. Refer to individual product features section for information.
- Optional power units mounted to center of table as standard. Also available on front and side of seating unit.
- When specifying electrical or overhead LED light fixture, cord exit grommet placement must be specified, as well as power source location, as applicable.
- Unit is affixed to wall with provided mounting hardware.

ACCENT TIER PRODUCT FEATURES:

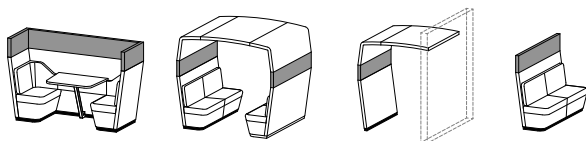

- Veneer panels available in Maple, Walnut and White Oak wood species and feature horizontal grain direction only.
- Laminate and whiteboard panels also available and will be applied to both sides as standard.
- Veneer, laminate and whiteboard can be intermixed (interior and exterior accent tier panel does not have to be the same material). List model number with applicable interior surface material code first, followed by exterior surface material code (e.g. #6512-WB-V represents unit with whiteboard on the interior and veneer on the exterior).
- Note: upholstery accent tier panel must be upholstered on both interior and exterior of units (cannot mix materials).
- Solid wood end caps to match accent tier finish, unless otherwise specified. When intermixing materials, end cap finish must be specified.
- Note: wood grain on solid wood end caps will run vertically.

CO-OP MEETING SPACES

designed by qdesign



SIN #711-16

LINKING TABLE PRODUCT FEATURES:

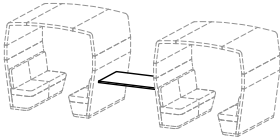

- Linking table can be mounted between any tapered 60" and 72" wide seating or wall panel units.
- 29" and 39" mounted heights.
- Available in 30" and 36" depths, in lengths of 60" and 72".
- Tables available in Maple, Walnut and White Oak veneer, as well as laminate selections.
- Optional power units mounted to center of table as standard.
- When specifying electrical, cord exit grommet placement must be specified on the applicable seating unit, as well as power source location, as applicable.

CANTILEVER TABLE PRODUCT FEATURES:

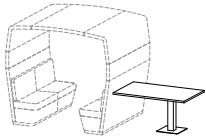

- Cantilever table can be affixed to any tapered 60" and 72" wide seating or wall panel unit.
- 29" and 39" table heights.
- Available in 30" and 36" depths, in lengths of 60" and 72".
- Tables available in Maple, Walnut and White Oak veneer, as well as laminate selections. Refer to General Product Features on page 1 for edge detail specifications.
- Table column dimensions: 4³/₄" x 4³/₄". Table base plate dimensions: 22" x 22".
- Column and base plate available in standard and premium metal finishes.
- Optional power units mounted to center of table as standard.
- When specifying electrical, cord exit grommet placement must be specified on the applicable seating unit, as well as power source location, as applicable.

STORAGE CUBBY PRODUCT FEATURES:

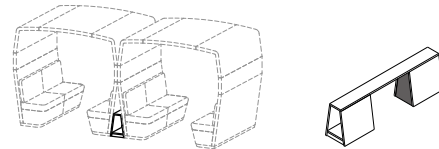

- Double-sided unit fits between tapered spaces of back-to-back 60" and 72" wide models.
- 60" and 72" lengths available.
- Available in Maple, Walnut and White Oak veneer, as well as laminate selections.
- Inside clearance, per cubby: 6" wide at the top, 10" wide at the bottom and 14¹/₄" high.
- Ships separately.

CO-OP MEETING SPACES

designed by qdesign



SIN #711-16

SHELF PRODUCT FEATURES:

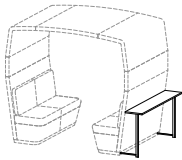

- Shelf available on all tapered 60" and 72" wide models.
- Available in 30" and 40" heights.
- Shelf depth is 12" with 150 lbs. maximum weight allowance.
- Available in Maple, Walnut and White Oak veneer, as well as laminate selections. Refer to General Product Features on page 1 for edge detail specifications.
- Shelf support posts available in standard and premium metal finishes.
- Ships separately and requires field-assembly.

STAND-ALONE SEATING UNIT PRODUCT FEATURES:

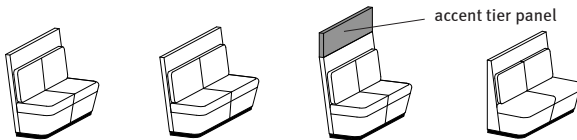

- Available in 60" and 72" widths, with 43¹/₂" and 56³/₄" heights.
- 90-degree back models also offered.
- Accent tier panel on 56³/₄" high models available in upholstery, veneer, laminate or whiteboard material. Refer to Accent Tier product features section (page 5).
- Power units available on front and side of seating units. Position must be specified, in addition to cord exit grommet placement and power source location, as applicable.
- Optional storage cubby available. Refer to individual product features section for information. Not offered on 90-degree back models.

BACK-TO-BACK MODELS PRODUCT FEATURES:

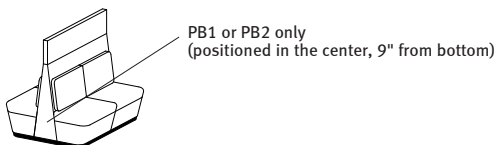

- Available in 60" and 72" widths, with 43¹/₂" and 56³/₄" heights.
- Accent tier panel on 56³/₄" high models available in upholstery, veneer, laminate or whiteboard material. Refer to Accent Tier product features section (page 5).
- Power units available on front and side of seating units. Only PB1 and PB2 units can be used for center-side panel placement. Position must be specified, in addition to cord exit grommet placement and power source location, as applicable.
- Accessories not available.

SHIPPING:

- All seating models ship blanket-wrap as standard.
- If cartoning is required, a 5% upcharge (based on the COM List Price), will be added to each applicable product. Please contact Customer Service for additional information and assistance with cartoning requirements as needed.

CO-OP MEETING SPACES

designed by qdesign



SIN #711-16

POWER UNITS:

- PB1, PB2 and PB3 units available for placement below seats, as well as on integrated, connected, cantilever and linking tables.
- PB1 and PB2 dimensions: 5³/₄" W x 2¹/₂" D
- PB3 dimensions: 6¹/₂" W x 2¹/₂" D
- Metallic silver or white finish with 108" electrical cord.
- UL listed.
- PB1 unit features one outlet and two USB charging ports.
- PB2 unit features two outlets.
- PB3 unit features two outlets and two USB charging ports.
- PP1, PP2 and PP3 Portal Power units also available for integrated, suspended, cantilever and linking tables only.
- PB5 power unit (for monitor-ready mounting only) includes two outlets, two USB charging ports and one HDMI jack.
- **Cord exit grommet position must always be specified as well as power source location, as applicable.**



PB1

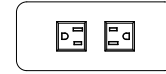

PB2

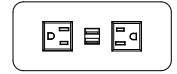

PB3

STANDARD POWER UNIT PLACEMENT, SEATING UNITS:

- Drawings reflect the general standard locations for electrical unit placement.
- For custom placements, please contact Customer Service.

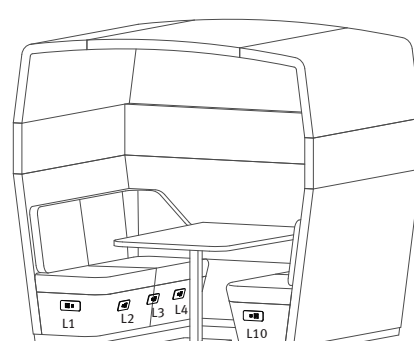
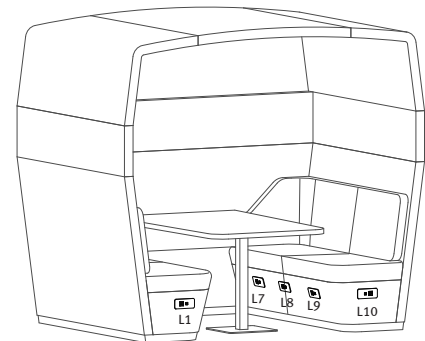
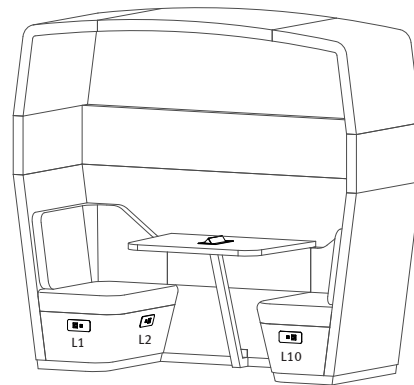
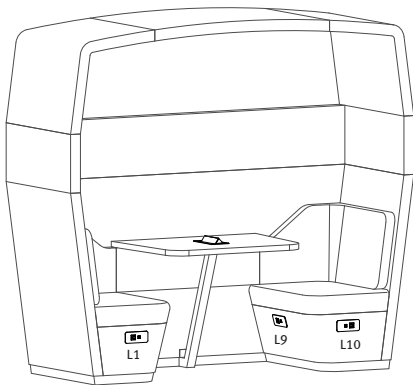

CO-OP MEETING SPACES

designed by qdesign



SIN #711-16

STANDARD POWER UNIT PLACEMENT, SEATING UNITS (CONTINUED):

- Drawings reflect the general standard locations for electrical unit placement.
- For custom placements, please contact Customer Service.

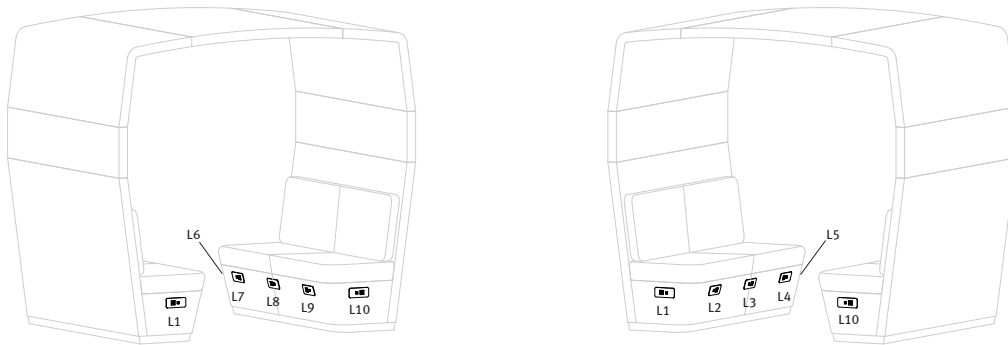

OVERHEAD LED LIGHT FIXTURE AND BUTTON POSITION:

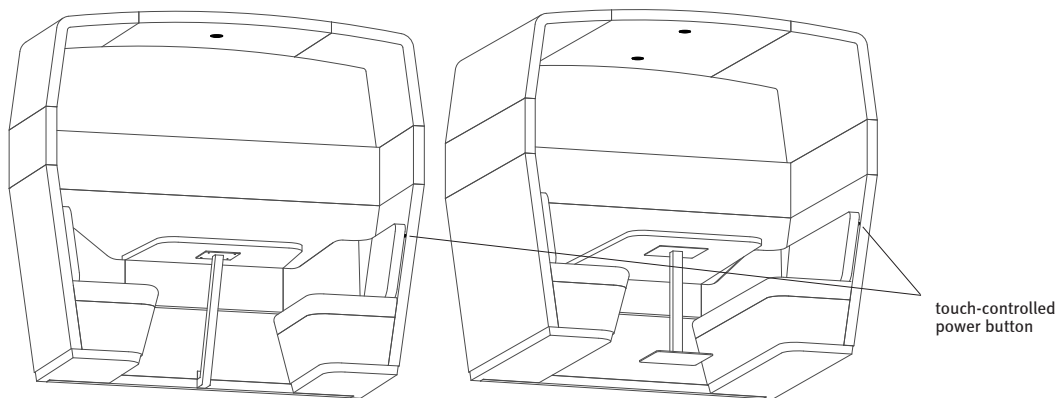

CO-OP MEETING SPACES

designed by qdesign



SIN #711-16

STANDARD CORD EXIT LOCATION

- Please reference the appropriate grommet exit code location when specifying electrical or overhead LED light fixture.
- G7 and G8 locations on full unit are for tv/monitor integration (both required). Maximum tv/monitor size is 42".
- For custom placements, please contact Customer Service.

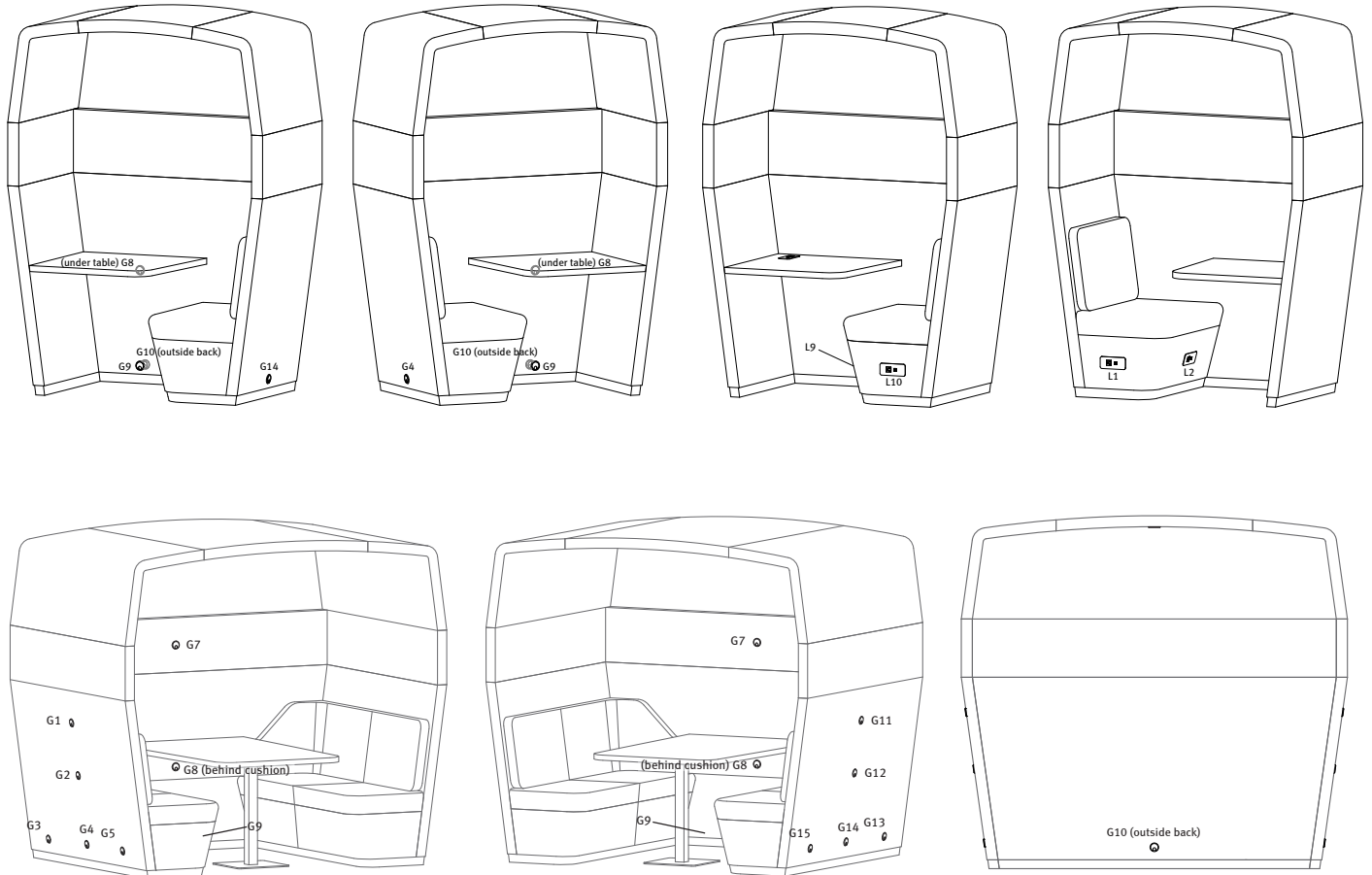

NOTES:

- Fully upholstered seating models with black plinth base. Refer to page 2 for product details.
- When specifying electrical or over-head LED light fixture, cord exit grommet position must be specified as well as power source location, as applicable.

SPECIFY:

- Model number
- Upholstery selection
- Table top and edge wood species
- Table top and edge wood finish
- Table post finish
- Options, as applicable

ORDERING EXAMPLE:

#6514-65TA-PB1-W

Public Single Work Module
Power Band 1 Unit, White
Table Placement

CO-OP
MEETING SPACES

designed by qdesign

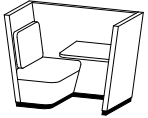
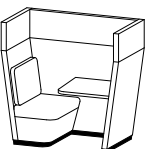
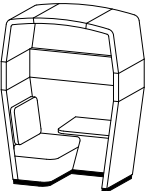

SIN #711-16

MODEL NUMBER	PRODUCT SPECIFICATIONS	FABRIC GRADES								
		COM	1	2	3	4	5	6	7	8
6514-65TA 	Public Single Work Module, Left Side Seated, as Facing W 58 ¹ / ₂ D 30 H 43 ¹ / ₂ Seat Height 18 Inside Seat Width 27 ¹ / ₂ Inside Seat Depth 19 11 ¹ / ₂ yds. 195 lbs. TB 133, add \$552 List	4287	4940	5097	5374	5652	5918	6195	6449	6727
6515-65TA 	Private Single Work Module, Left Side Seated, as Facing W 58 ¹ / ₂ D 30 H 56 ³ / ₄ Seat Height 18 Inside Seat Width 27 ¹ / ₂ Inside Seat Depth 19 15 ¹ / ₂ yds. 220 lbs. TB 133, add \$744 List	5663	6542	6754	7128	7503	7861	8235	8577	8951
6516-65TA 	Private Single Work Module, Full Canopy, Left Side Seated, as Facing W 58 ¹ / ₂ D 30 H 79 ¹ / ₂ Seat Height 18 Inside Seat Width 27 ¹ / ₂ Inside Seat Depth 19 20 ¹ / ₂ yds. 280 lbs. TB 133, add \$984 List	7285	8448	8728	9223	9718	10191	10686	11138	11634

OPTIONS (XXXX - REFERS TO LOUNGE MODEL NUMBER)

MODEL	DESCRIPTION	LIST
XXXX-MB02	Moisture Barrier, Seats Only	95
XXXX-LED1	LED Light (one fixture, full canopy only)	350

FOR PLACEMENT BELOW SEATS AND/OR INTEGRATED TABLE

XXXX-PB1-S	Power Band 1 (one power, two USB), Silver	413
XXXX-PB1-W	Power Band 1 (one power, two USB), White	413
XXXX-PB2-S	Power Band 2 (dual power), Silver	322
XXXX-PB2-W	Power Band 2 (dual power), White	322
XXXX-PB3-S	Power Band 3 (dual power, two USB), Silver	429
XXXX-PB3-W	Power Band 3 (dual power, two USB), White	429

FOR INTEGRATED TABLES ONLY, 4" X 4" FROM CORNER

XXXX-PP1	Portal Power 1 (one power, one data)	612
XXXX-PP2	Portal Power 2 (dual power)	542
XXXX-PP3	Portal Power 3 (one power, two USB)	643

CO-OP MEETING SPACES

designed by qdesign



SIN #711-16

NOTES:

- Seating models with accent tier. Refer to page 5 for product details.
- Accent tier available in Maple, Walnut and White Oak veneer (-V), laminate (-L) and whiteboard material (-WB). Please specify code for interior and exterior material selections.
- When specifying electrical or over-head LED light fixture, cord exit grommet position must be specified as well as power source location, as applicable.

SPECIFY:

1. Model number
2. Accent tier finish, interior
3. Accent tier finish, exterior
4. Upholstery selection
5. Table and edge wood species
6. Table and edge wood finish
7. Table post finish
8. Options, as applicable

ORDERING EXAMPLE:

#6516-V-V-65TA-PB1-S

Private Single Work Module
Veneer Accent Tier, Interior
Veneer Accent Tier, Exterior
Power Band 1 Unit, Silver
Seat Placement

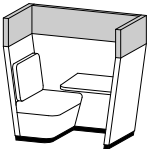
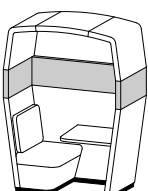
MODEL NUMBER	PRODUCT SPECIFICATIONS	FABRIC GRADES								
		COM	1	2	3	4	5	6	7	8
6515-(-)(-)-65TA 	Private Single Work Module, Non-Upholstered Accent Tier, Left Side Seated, as Facing W 58 ¹ / ₂ D 30 H 56 ³ / ₄ Seat Height 18 Inside Seat Width 27 ¹ / ₂ Inside Seat Depth 19 11 ¹ / ₂ yds. 280 lbs. TB 133, add \$552 List	7159	7812	7969	8246	8524	8790	9067	9321	9599
6516-(-)(-)-65TA 	Private Single Work Module, Full Canopy, Non-Upholstered Accent Tier, Left Side Seated, as Facing W 58 ¹ / ₂ D 30 H 79 ¹ / ₂ Seat Height 18 Inside Seat Width 27 ¹ / ₂ Inside Seat Depth 19 16 ¹ / ₂ yds. 280 lbs. TB 133, add \$792 List	8782	9718	9943	10342	10740	11121	11520	11884	12282

OPTIONS (XXXX - REFERS TO LOUNGE MODEL NUMBER)

MODEL	DESCRIPTION	LIST
XXXX-MB02	Moisture Barrier, Seats Only	95
XXXX-LED1	LED Light (one fixture, full canopy only)	350

FOR PLACEMENT BELOW SEATS

XXXX-PB1-S	Power Band 1 (one power, two USB), Silver	413
XXXX-PB1-W	Power Band 1 (one power, two USB), White	413
XXXX-PB2-S	Power Band 2 (dual power), Silver	322
XXXX-PB2-W	Power Band 2 (dual power), White	322
XXXX-PB3-S	Power Band 3 (dual power, two USB), Silver	429
XXXX-PB3-W	Power Band 3 (dual power, two USB), White	429

FOR INTEGRATED TABLES ONLY, 4" X 4" FROM CORNER

XXXX-PP1	Portal Power 1 (one power, one data)	612
XXXX-PP2	Portal Power 2 (dual power)	542
XXXX-PP3	Portal Power 3 (one power, two USB)	643

NOTES:

- Fully upholstered seating models with black plinth base. Refer to pages 2 for product details.
- When specifying electrical or over-head LED light fixture, cord exit grommet position must be specified as well as power source location, as applicable.

SPECIFY:

- Model number
- Accent tier finish, interior
- Accent tier finish, exterior
- Upholstery selection
- Table and edge wood species
- Table and edge wood finish
- Table post finish
- Options, as applicable

ORDERING EXAMPLE:

#6518-65TA-PB1-W

Private Single Work Module
Power Band 1 Unit, White
Table Placement

CO-OP
MEETING SPACES

designed by qdesign



SIN #711-16

MODEL NUMBER	PRODUCT SPECIFICATIONS	FABRIC GRADES								
		COM	1	2	3	4	5	6	7	8
6517-65TA 	Public Single Work Module, Right Side Seated, as Facing W 58 ¹ / ₂ D 30 H 43 ¹ / ₂ Seat Height 18 Inside Seat Width 27 ¹ / ₂ Inside Seat Depth 19 11 ¹ / ₂ yds. 195 lbs. TB 133, add \$552 List	4287	4940	5097	5374	5652	5918	6195	6449	6727
6518-65TA 	Private Single Work Module, Right Side Seated, as Facing W 58 ¹ / ₂ D 30 H 56 ³ / ₄ Seat Height 18 Inside Seat Width 27 ¹ / ₂ Inside Seat Depth 19 15 ¹ / ₂ yds. 220 lbs. TB 133, add \$744 List	5663	6542	6754	7128	7503	7861	8235	8577	8951
6519-65TA 	Private Single Work Module, Full Canopy, Right Side Seated, as Facing W 58 ¹ / ₂ D 30 H 79 ¹ / ₂ Seat Height 18 Inside Seat Width 27 ¹ / ₂ Inside Seat Depth 19 20 ¹ / ₂ yds. 280 lbs. TB 133, add \$984 List	7285	8448	8728	9223	9718	10191	10686	11138	11634

OPTIONS (XXXX - REFERS TO LOUNGE MODEL NUMBER)

MODEL	DESCRIPTION	LIST
XXXX-MB02	Moisture Barrier, Seats Only	95
XXXX-LED1	LED Light (one fixture, full canopy only)	350

FOR PLACEMENT BELOW SEATS

XXXX-PB1-S	Power Band 1 (one power, two USB), Silver	413
XXXX-PB1-W	Power Band 1 (one power, two USB), White	413
XXXX-PB2-S	Power Band 2 (dual power), Silver	322
XXXX-PB2-W	Power Band 2 (dual power), White	322
XXXX-PB3-S	Power Band 3 (dual power, two USB), Silver	429
XXXX-PB3-W	Power Band 3 (dual power, two USB), White	429

FOR INTEGRATED TABLES ONLY, 4" X 4" FROM CORNER

XXXX-PP1	Portal Power 1 (one power, one data)	612
XXXX-PP2	Portal Power 2 (dual power)	542
XXXX-PP3	Portal Power 3 (one power, two USB)	643

CO-OP MEETING SPACES

designed by qdesign



SIN #711-16

NOTES:

- Seating models with accent tier. Refer to page 5 for product details.
- Accent tier available in Maple, Walnut and White Oak veneer (-V), laminate (-L) and whiteboard material (-WB). Please specify code for interior and exterior material selections.
- When specifying electrical or over-head LED light fixture, cord exit grommet position must be specified as well as power source location, as applicable.

SPECIFY:

1. Model number
2. Accent tier finish, interior
3. Accent tier finish, exterior
4. Upholstery selection
5. Table and edge wood species
6. Table and edge wood finish
7. Table post finish
8. Options, as applicable

ORDERING EXAMPLE:

#6519-V-WB-65TA-PB1-W
Private Single Work Module Veneer Accent Tier, Interior Whiteboard Accent Tier, Exterior Power Band 1 Unit, White Table Placement

MODEL NUMBER PRODUCT SPECIFICATIONS FABRIC GRADES

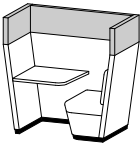
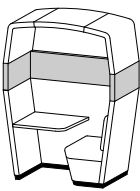
		COM	1	2	3	4	5	6	7	8
6518-(-)-(-)-65TA	 <p>Private Single Work Module, Non-Upholstered Accent Tier, Right Side Seated, as Facing W 58¹/₂ D 30 H 56³/₄ Seat Height 18 Inside Seat Width 27¹/₂ Inside Seat Depth 19 11¹/₂ yds. 280 lbs. TB 133, add \$552 List</p>	7159	7812	7969	8246	8524	8790	9067	9321	9599
6519-(-)-(-)-65TA	 <p>Private Single Work Module, Full Canopy, Non-Upholstered Accent Tier, Right Side Seated, as Facing W 58¹/₂ D 30 H 79¹/₂ Seat Height 18 Inside Seat Width 27¹/₂ Inside Seat Depth 19 16¹/₂ yds. 280 lbs. TB 133, add \$792 List</p>	8782	9718	9943	10342	10740	11121	11520	11884	12282

OPTIONS (XXXX - REFERS TO LOUNGE MODEL NUMBER)

MODEL	DESCRIPTION	LIST
XXXX-MB02	Moisture Barrier, Seats Only	95
XXXX-LED1	LED Light (one fixture, full canopy only)	350

FOR PLACEMENT BELOW SEATS		FOR INTEGRATED TABLES ONLY, 4" X 4" FROM CORNER	
XXXX-PB1-S	Power Band 1 (one power, two USB), Silver	XXX-PP1	Portal Power 1 (one power, one data) 612
XXXX-PB1-W	Power Band 1 (one power, two USB), White	XXXX-PP2	Portal Power 2 (dual power) 542
XXXX-PB2-S	Power Band 2 (dual power), Silver	XXXX-PP3	Portal Power 3 (one power, two USB) 643
XXXX-PB2-W	Power Band 2 (dual power), White		
XXXX-PB3-S	Power Band 3 (dual power, two USB), Silver		
XXXX-PB3-W	Power Band 3 (dual power, two USB), White		

NOTES:

- Fully upholstered seating models with black plinth base. Refer to pages 2-3 for product details.
- For units with integrated table, please refer to page 17.
- When specifying electrical or over-head LED light fixture, cord exit grommet position must be specified as well as power source location, as applicable.

SPECIFY:

1. Model number
2. Upholstery selection
3. Options, as applicable

ORDERING EXAMPLE:

#6512-PB1-S

Private Lounge w/Full Canopy
Power Band 1 Unit, Silver

CO-OP
MEETING SPACES

designed by qdesign

SIN #711-16

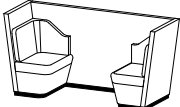
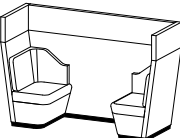
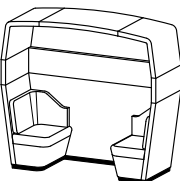
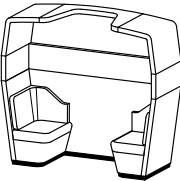
MODEL NUMBER	PRODUCT SPECIFICATIONS	FABRIC GRADES								
		COM	1	2	3	4	5	6	7	8
6510 	Public Lounge Unit W 88 ¹ / ₂ D 30 H 43 ¹ / ₂ Seat Height 18 Inside Seat Width 25 ¹ / ₂ Inside Seat Depth 19 15 ¹ / ₄ yds. 290 lbs. TB 133, add \$732 List	4567	5432	5640	6009	6377	6729	7097	7434	7802
6511 	Private Lounge Unit W 88 ¹ / ₂ D 30 H 56 ³ / ₄ Seat Height 18 Inside Seat Width 25 ¹ / ₂ Inside Seat Depth 19 20 yds. 351 lbs. TB 133, add \$960 List	5945	7079	7352	7835	8318	8780	9263	9704	10187
6512 	Private Lounge Unit with Full Canopy W 88 ¹ / ₂ D 30 H 80 ¹ / ₄ Seat Height 18 Inside Seat Width 25 ¹ / ₂ Inside Seat Depth 19 25 ¹ / ₂ yds. 416 lbs. TB 133, add \$1224 List	7574	9020	9368	9984	10600	11189	11805	12367	12983
6513 	Private Lounge Unit with Partial Canopy W 88 ¹ / ₂ D 30 H 80 ¹ / ₄ Seat Height 18 Inside Seat Width 25 ¹ / ₂ Inside Seat Depth 19 25 ¹ / ₂ yds. 411 lbs. TB 133, add \$1200 List	7617	9035	9376	9980	10584	11161	11765	12316	12920

OPTIONS (XXXX - REFERS TO LOUNGE MODEL NUMBER)

MODEL	DESCRIPTION	LIST
XXXX-MB06	Moisture Barrier, Seats Only	190
XXXX-LED1	LED Light (one fixture, full canopy only)	350

FOR PLACEMENT BELOW SEATS

XXXX-PB1-S	Power Band 1 (one power, two USB), Silver	412
XXXX-PB1-W	Power Band 1 (one power, two USB), White	412
XXXX-PB2-S	Power Band 2 (dual power), Silver	322
XXXX-PB2-W	Power Band 2 (dual power), White	322
XXXX-PB3-S	Power Band 3 (dual power, two USB), Silver	429
XXXX-PB3-W	Power Band 3 (dual power, two USB), White	429

CO-OP MEETING SPACES

designed by qdesign

NOTES:

- Seating models with accent tier. Refer to page 5 for product details.
- For units with integrated table, please refer to page 18.
- Accent tier available in Maple, Walnut and White Oak veneer (-V), laminate (-L) and whiteboard material (-WB). Please specify code for interior and exterior material selections.
- Standard with black plinth base.
- When specifying electrical or over-head LED light fixture, cord exit grommet position must be specified as well as power source location, as applicable.

SPECIFY:

1. Model number
2. Accent tier finish, interior
3. Accent tier finish, exterior
4. Upholstery selection
5. Options, as applicable

ORDERING EXAMPLE:

#6513-V-V-MB03
Private Lounge w/Partial Canopy
Veneer Accent Tier, Interior
Veneer Accent Tier, Exterior
Moisture Barrier

SIN #711-16

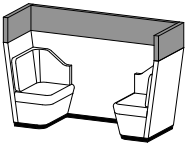
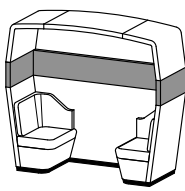
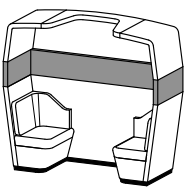
MODEL NUMBER	PRODUCT SPECIFICATIONS	FABRIC GRADES								
		COM	1	2	3	4	5	6	7	8
<p>Specify Interior Material Code, Followed by Exterior Material Code V = Veneer L = Laminate WB = Whiteboard</p>										
<p>6511-()-()</p> 	<p>Private Lounge Unit Non-Upholstered Accent Tier W 88¹/₂ D 30 H 56³/₄ Seat Height 18 Inside Seat Width 25¹/₂ Inside Seat Depth 19 15¹/₄ yds. 360 lbs. TB 133, add \$732 List</p>	7438	8303	8511	8880	9248	9600	9968	10305	10673
<p>6512-()-()</p> 	<p>Private Lounge Unit with Full Canopy Non-Upholstered Accent Tier W 88¹/₂ D 30 H 80¹/₄ Seat Height 18 Inside Seat Width 25¹/₂ Inside Seat Depth 19 20³/₄ yds. 425 lbs. TB 133, add \$996 List</p>	9068	10245	10528	11029	11530	12010	12511	12968	13470
<p>6513-()-()</p> 	<p>Private Lounge Unit with Partial Canopy Non-Upholstered Accent Tier W 88¹/₂ D 30 H 80¹/₄ Seat Height 18 Inside Seat Width 25¹/₂ Inside Seat Depth 19 20³/₄ yds. 420 lbs. TB 133, add \$996 List</p>	9110	10287	10570	11071	11572	12052	12553	13010	13512

OPTIONS (XXXX - REFERS TO LOUNGE MODEL NUMBER)

MODEL	DESCRIPTION	LIST
XXXX-MB06	Moisture Barrier, Seats Only	190
XXXX-LED1	LED Light (one fixture, full canopy only)	350

FOR PLACEMENT BELOW SEATS

XXXX-PB1-S	Power Band 1 (one power, two USB), Silver	412
XXXX-PB1-W	Power Band 1 (one power, two USB), White	412
XXXX-PB2-S	Power Band 2 (dual power), Silver	322
XXXX-PB2-W	Power Band 2 (dual power), White	322
XXXX-PB3-S	Power Band 3 (dual power, two USB), Silver	429
XXXX-PB3-W	Power Band 3 (dual power, two USB), White	429

NOTES:

- Fully upholstered seating models with integrated table. Refer to pages 2-3 for product details.
- Standard with black plinth base.
- 27" high integrated table available in Maple, Walnut and White Oak veneer as well as laminate selections.
- When specifying electrical or over-head LED light fixture, cord exit grommet position must be specified as well as power source location, as applicable.

SPECIFY:

- Model number
- Upholstery selection
- Table top and edge wood species
- Table top and edge wood finish
- Table post finish
- Options, as applicable

ORDERING EXAMPLE:

#6510-65TS-PP1

Public Lounge w/Table
Portal Power 1 Unit, Table
Placement

**CO-OP
MEETING SPACES**

designed by qdesign

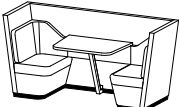
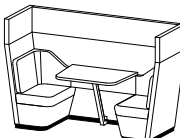
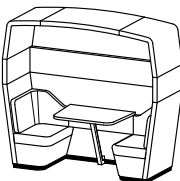
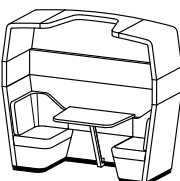

SIN #711-16

MODEL NUMBER	PRODUCT SPECIFICATIONS	FABRIC GRADES								
		COM	1	2	3	4	5	6	7	8
6510-65TS 	Public Lounge Unit with Integrated Table W 88 ¹ / ₂ D 30 H 43 ¹ / ₂ Seat Height 18 Inside Seat Width 25 ¹ / ₂ Inside Seat Depth 19 16 ¹ / ₄ yds. 327 lbs. TB 133, add \$780 List	5736	6658	6880	7272	7665	8040	8432	8791	9183
6511-65TS 	Private Lounge Unit with Integrated Table W 88 ¹ / ₂ D 30 H 56 ³ / ₄ Seat Height 18 Inside Seat Width 25 ¹ / ₂ Inside Seat Depth 19 21 yds. 388 lbs. TB 133, add \$1008 List	7113	8304	8591	9098	9605	10090	10597	11060	11568
6512-65TS 	Private Lounge Unit with Full Canopy and Integrated Table W 88 ¹ / ₂ D 30 H 80 ¹ / ₄ Seat Height 18 Inside Seat Width 25 ¹ / ₂ Inside Seat Depth 19 26 ¹ / ₂ yds. 453 lbs. TB 133, add \$1272 List	8743	10246	10608	11248	11888	12500	13140	13724	14364
6513-65TS 	Private Lounge Unit with Partial Canopy and Integrated Table W 88 ¹ / ₂ D 30 H 80 ¹ / ₄ Seat Height 18 Inside Seat Width 25 ¹ / ₂ Inside Seat Depth 19 26 ¹ / ₂ yds. 448 lbs. TB 133, add \$1272 List	8786	10289	10651	11291	11931	12543	13183	13767	14407

OPTIONS (XXXX - REFERS TO LOUNGE MODEL NUMBER)

MODEL	DESCRIPTION	LIST
XXXX-MB06	Moisture Barrier, Seats Only	190
XXXX-LED1	LED Light (one fixture, full canopy only)	350
XXXX-PF03	Premium Finish, Table Post	110

FOR PLACEMENT BELOW SEATS AND/OR CENTER OF INTEGRATED TABLES

XXXX-PB1-S	Power Band 1 (one power, two USB), Silver	413
XXXX-PB1-W	Power Band 1 (one power, two USB), White	413
XXXX-PB2-S	Power Band 2 (dual power), Silver	322
XXXX-PB2-W	Power Band 2 (dual power), White	322
XXXX-PB3-S	Power Band 3 (dual power, two USB), Silver	429
XXXX-PB3-W	Power Band 3 (dual power, two USB), White	429

FOR INTEGRATED TABLES ONLY, CENTERED 5" FROM BACK

XXXX-PP1	Portal Power 1 (one power, one data)	612
XXXX-PP2	Portal Power 2 (dual power)	542
XXXX-PP3	Portal Power 3 (one power, two USB)	643

CO-OP MEETING SPACES

designed by qdesign

NOTES:

- Seating models with accent tier. Refer to page 5 for product details.
- Accent tier available in Maple, Walnut and White Oak veneer (-V), laminate (-L) and whiteboard material (-WB). Please specify code for interior and exterior material selections.
- Standard with black plinth base.
- 27" high integrated table available in Maple, Walnut and White Oak veneer as well as laminate selections.
- When specifying electrical or over-head LED light fixture, cord exit grommet position must be specified as well as power source location, as applicable.

SPECIFY:

1. Model number
2. Accent tier finish, interior
3. Accent tier finish, exterior
4. Upholstery selection
5. Table and edge wood species
6. Table and edge wood finish
7. Table post finish
8. Options, as applicable

ORDERING EXAMPLE:

#6512-WB-WB-65TS-PF03

Private Lounge w/Full Canopy and Table
Whiteboard Accent Tier, Interior
Whiteboard Accent Tier, Exterior
Table Post Premium Finish

SIN #711-16

MODEL NUMBER	PRODUCT SPECIFICATIONS	FABRIC GRADES								
		COM	1	2	3	4	5	6	7	8
Specify Interior Material Code, Followed by Exterior Material Code V = Veneer L = Laminate WB = Whiteboard										
6511-(-)-(-)-65TS	Private Lounge Unit with Integrated Table Non-Upholstered Accent Tier W 88 ¹ / ₂ D 30 H 56 ³ / ₄ Seat Height 18 Inside Seat Width 25 ¹ / ₂ Inside Seat Depth 19 16 ¹ / ₄ yds. 397 lbs. TB 133, add \$780 List	8607	9529	9751	10143	10536	10911	11303	11662	12054
6512-(-)-(-)-65TS	Private Lounge Unit with Full Canopy and Integrated Table, Non-Upholstered Accent Tier W 88 ¹ / ₂ D 30 H 80 ¹ / ₄ Seat Height 18 Inside Seat Width 25 ¹ / ₂ Inside Seat Depth 19 21 ³ / ₄ yds. 462 lbs. TB 133, add \$1044 List	10236	11470	11767	12292	12817	13320	13845	14324	14850
6513-(-)-(-)-65TS	Private Lounge Unit with Partial Canopy and Integrated Table, Non-Upholstered Accent Tier W 88 ¹ / ₂ D 30 H 80 ¹ / ₄ Seat Height 18 Inside Seat Width 25 ¹ / ₂ Inside Seat Depth 19 21 ³ / ₄ yds. 457 lbs. TB 133, add \$1044 List	10279	11513	11810	12335	12860	13363	13888	14367	14893

OPTIONS (XXXX - REFERS TO LOUNGE MODEL NUMBER)

MODEL	DESCRIPTION	LIST
XXXX-MB06	Moisture Barrier, Seats Only	190
XXXX-LED1	LED Light (one fixture, full canopy only)	350
XXXX-PF03	Premium Finish, Table Post	110

FOR PLACEMENT BELOW SEATS AND/OR CENTER OF INTEGRATED TABLES

XXXX-PB1-S	Power Band 1 (one power, two USB), Silver	413
XXXX-PB1-W	Power Band 1 (one power, two USB), White	413
XXXX-PB2-S	Power Band 2 (dual power), Silver	322
XXXX-PB2-W	Power Band 2 (dual power), White	322
XXXX-PB3-S	Power Band 3 (dual power, two USB), Silver	429
XXXX-PB3-W	Power Band 3 (dual power, two USB), White	429

FOR INTEGRATED TABLES ONLY, CENTERED 5" FROM BACK

XXX-PP1	Portal Power 1 (one power, one data)	612
XXXX-PP2	Portal Power 2 (dual power)	542
XXXX-PP3	Portal Power 3 (one power, two USB)	643

NOTES:

- Fully upholstered seating models with black plinth base. Refer to pages 2-3 for product details.
- For units with integrated table, please refer to page 21.
- When specifying electrical or over-head LED light fixture, cord exit grommet position must be specified as well as power source location, as applicable.

SPECIFY:

- Model number
- Upholstery selection
- Options, as applicable

ORDERING EXAMPLE:

#6520-PB1-W
Public Love Seat
Power Band 1 Unit, White

CO-OP
MEETING SPACES

designed by qdesign

SIN #711-16

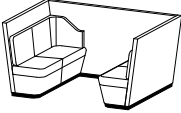
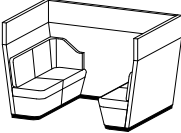
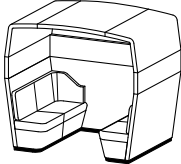
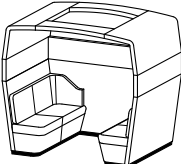
MODEL NUMBER	PRODUCT SPECIFICATIONS	FABRIC GRADES								
		COM	1	2	3	4	5	6	7	8
6520 	Public Love Seat Unit W 88 ¹ / ₂ D 60 H 43 ¹ / ₂ Seat Height 18 Inside Seat Width 55 ¹ / ₄ Inside Seat Depth 19 23 ³ / ₄ yds. 480 lbs. TB 133, add \$1116 List	5779	7098	7415	7977	8538	9075	9637	10149	10711
6521 	Private Love Seat Unit W 88 ¹ / ₂ D 60 H 56 ³ / ₄ Seat Height 18 Inside Seat Width 55 ¹ / ₄ Inside Seat Depth 19 30 yds. 535 lbs. TB 133, add \$1440 List	7422	9123	9533	10257	10982	11675	12399	13061	13785
6522 	Private Love Seat Unit with Full Canopy W 88 ¹ / ₂ D 60 H 80 ¹ / ₄ Seat Height 18 Inside Seat Width 55 ¹ / ₄ Inside Seat Depth 19 41 ¹ / ₂ yds. 665 lbs. TB 133, add \$1992 List	9704	12058	12624	13626	14628	15587	16589	17504	18507
6523 	Private Love Seat with Open Canopy W 88 ¹ / ₂ D 60 H 80 ¹ / ₄ Seat Height 18 Inside Seat Width 55 ¹ / ₄ Inside Seat Depth 19 39 ³ / ₄ yds. 639 lbs. TB 133, add \$1908 List	9762	12016	12559	13519	14479	15397	16357	17234	18193

OPTIONS (XXXX - REFERS TO LOVE SEAT NUMBER)

MODEL	DESCRIPTION	LIST	OPTIONAL ACCESSORIES	PAGE REFERENCE
XXXX-MB07	Moisture Barrier, Seats Only	290	Shelf	page 39
XXXX-LED2	LED Light (two fixtures, full canopy only)	500	Linking Table	page 40
XXXX-MR5	Monitor Ready Mounting (includes PB5 table-mounted power unit)	665	Cantilever Table	page 40
			Storage Cubby	page 41

FOR PLACEMENT BELOW SEATS

XXXX-PB1-S	Power Band 1 (one power, two USB), Silver	413
XXXX-PB1-W	Power Band 1 (one power, two USB), White	413
XXXX-PB2-S	Power Band 2 (dual power), Silver	322
XXXX-PB2-W	Power Band 2 (dual power), White	322
XXXX-PB3-S	Power Band 3 (dual power, two USB), Silver	429
XXXX-PB3-W	Power Band 3 (dual power, two USB), White	429

CO-OP MEETING SPACES

designed by qdesign

NOTES:

- Seating models with accent tier. Refer to page 5 for product details.
- For units with integrated table, please refer to page 22.
- Accent tier available in Maple, Walnut and White Oak veneer (-V), laminate (-L) and whiteboard material (-WB). Please specify code for interior and exterior material selections.
- Standard with black plinth base.
- When specifying electrical or over-head LED light fixture, cord exit grommet position must be specified as well as power source location, as applicable.

SPECIFY:

1. Model number
2. Accent tier finish, interior
3. Accent tier finish, exterior
4. Upholstery selection
5. Options, as applicable

ORDERING EXAMPLE:

#6523-V-WB-PB3-S
 Private Love Seat w/Open Canopy
 Veneer Accent Tier, Interior Whiteboard Accent Tier, Exterior Power Band 3 Unit, Silver

SIN #711-16

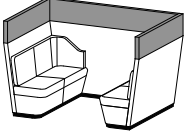
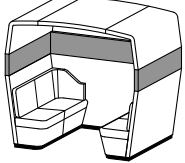
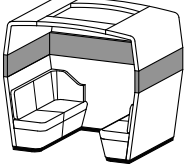
MODEL NUMBER	PRODUCT SPECIFICATIONS	FABRIC GRADES								
		COM	1	2	3	4	5	6	7	8
<p>Specify Interior Material Code, Followed by Exterior Material Code V = Veneer L = Laminate WB = Whiteboard</p>										
<p>6521-()-()</p> 	<p>Private Love Seat Unit Non-Upholstered Accent Tier W 88¹/₂ D 60 H 56³/₄ Seat Height 18 Inside Seat Width 55¹/₄ Inside Seat Depth 19 23¹/₄ yds. 550 lbs. TB 133, add \$1116 List</p>	9842	11161	11478	12040	12601	13138	13700	14212	14774
<p>6522-()-()</p> 	<p>Private Love Seat Unit with Full Canopy, Non-Upholstered Accent Tier W 88¹/₂ D 60 H 80¹/₄ Seat Height 18 Inside Seat Width 55¹/₄ Inside Seat Depth 19 34³/₄ yds. 680 lbs. TB 133, add \$1668 List</p>	12124	14095	14569	15408	16248	17050	17890	18656	19495
<p>6523-()-()</p> 	<p>Private Love Seat Unit with Open Canopy, Non-Upholstered Accent Tier W 88¹/₂ D 60 H 80¹/₄ Seat Height 18 Inside Seat Width 55¹/₄ Inside Seat Depth 19 33 yds. 654 lbs. TB 133, add \$1584 List</p>	12184	14056	14506	15303	16100	16862	17659	18387	19184

OPTIONS (XXXX - REFERS TO LOUNGE MODEL NUMBER)

MODEL	DESCRIPTION	LIST	OPTIONAL ACCESSORIES	PAGE REFERENCE
XXXX-MB07	Moisture Barrier, Seats Only	290	Shelf	page 39
XXXX-LED2	LED Light (two fixtures, full canopy only)	500	Linking Table	page 40
XXXX-MR5	Monitor Ready Mounting (includes PB5 table-mounted power unit)	665	Cantilever Table Storage Cubby	page 40 page 41

FOR PLACEMENT BELOW SEATS

XXXX-PB1-S	Power Band 1 (one power, two USB), Silver	412
XXXX-PB1-W	Power Band 1 (one power, two USB), White	412
XXXX-PB2-S	Power Band 2 (dual power), Silver	322
XXXX-PB2-W	Power Band 2 (dual power), White	322
XXXX-PB3-S	Power Band 3 (dual power, two USB), Silver	429
XXXX-PB3-W	Power Band 3 (dual power, two USB), White	429

NOTES:

- Fully upholstered seating models with integrated table. Refer to pages 2-3 for product details.
- Standard with black plinth base.
- 27" high integrated table available in Maple, Walnut and White Oak veneer as well as laminate selections.
- Table support post dimensions include 2" x 2" column and 14" x 14" base plate.
- When specifying electrical or over-head LED light fixture, cord exit grommet position must be specified as well as power source location, as applicable.

SPECIFY:

- Model number
- Upholstery selection
- Table top and edge wood species
- Table top and edge wood finish
- Table post finish
- Options, as applicable

ORDERING EXAMPLE:

#6521-65TL-PB3-S

Private Love Seat with Table
Power Band 3 Unit, Silver
Seat Placement

CO-OP
MEETING SPACES

designed by qdesign

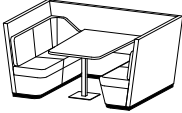
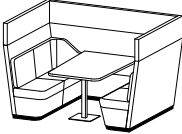
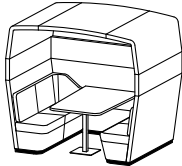
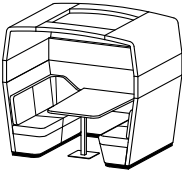

SIN #711-16

MODEL NUMBER	PRODUCT SPECIFICATIONS	FABRIC GRADES								
		COM	1	2	3	4	5	6	7	8
6520-65TL 	Public Love Seat Unit with Integrated Table W 88 ¹ / ₂ D 60 H 43 ¹ / ₂ Seat Height 18 Inside Seat Width 55 ¹ / ₄ Inside Seat Depth 19 24 ¹ / ₄ yds. 547 lbs. TB 133, add \$1164 List	8109	9484	9815	10401	10987	11547	12133	12667	13253
6521-65TL 	Private Love Seat Unit with Integrated Table W 88 ¹ / ₂ D 60 H 56 ³ / ₄ Seat Height 18 Inside Seat Width 55 ¹ / ₄ Inside Seat Depth 19 31 yds. 622 lbs. TB 133, add \$1488 List	9753	11511	11934	12683	13432	14148	14896	15580	16329
6522-65TL 	Private Love Seat Unit with Full Canopy and Integrated Table W 88 ¹ / ₂ D 60 H 80 ¹ / ₄ Seat Height 18 Inside Seat Width 55 ¹ / ₄ Inside Seat Depth 19 42 ¹ / ₂ yds. 752 lbs. TB 133, add \$2040 List	12033	14443	15023	16050	17076	18058	19084	20021	21048
6523-65TL 	Private Love Seat with Open Canopy and Integrated Table W 88 ¹ / ₂ D 60 H 80 ¹ / ₄ Seat Height 18 Inside Seat Width 55 ¹ / ₄ Inside Seat Depth 19 40 ³ / ₄ yds. 726 lbs. TB 133, add \$1956 List	12092	14403	14959	15943	16927	17869	18853	19751	20736

OPTIONS (XXXX - REFERS TO LOVE SEAT NUMBER)

MODEL	DESCRIPTION	LIST	OPTIONAL ACCESSORIES	PAGE REFERENCE
XXXX-MB07	Moisture Barrier, Seats Only	290	Shelf	page 39
XXXX-LED2	LED Light (two fixtures, full canopy only)	500	Linking Table	page 40
XXXX-MR5	Monitor Ready Mounting (includes PB5 table-mounted power unit)	665	Cantilever Table	page 40
XXXX-PF03	Premium Finish, Table Post	110	Storage Cubby	page 41

FOR PLACEMENT BELOW SEATS AND/OR CENTER OF INTEGRATED TABLES

XXXX-PB1-S	Power Band 1 (one power, two USB), Silver	413
XXXX-PB1-W	Power Band 1 (one power, two USB), White	413
XXXX-PB2-S	Power Band 2 (dual power), Silver	322
XXXX-PB2-W	Power Band 2 (dual power), White	322
XXXX-PB3-S	Power Band 3 (dual power, two USB), Silver	429
XXXX-PB3-W	Power Band 3 (dual power, two USB), White	429

FOR INTEGRATED TABLES ONLY, CENTERED 5" FROM BACK

XXXX-PP1	Portal Power 1 (one power, one data)	612
XXXX-PP2	Portal Power 2 (dual power)	542
XXXX-PP3	Portal Power 3 (one power, two USB)	643

CO-OP MEETING SPACES

designed by qdesign

NOTES:

- Seating models with accent tier. Refer to page 5 for product details.
- Accent tier available in Maple, Walnut and White Oak veneer (-V), laminate (-L) and whiteboard material (-WB). Please specify code for interior and exterior material selections.
- Standard with black plinth base.
- 27" high integrated table available in Maple, Walnut and White Oak veneer as well as laminate selections.
- Table support post dimensions include 2" x 2" column and 14" x 14" base plate.

SPECIFY:

1. Model number
2. Accent tier finish, interior
3. Accent tier finish, exterior
4. Upholstery selection
5. Table wood species
6. Table wood finish
7. Table post finish
8. Options, as applicable

ORDERING EXAMPLE:

#6523-L-L-65TL-PF03-PP1
Private Love Seat w/Open Canopy and Table
Laminate Accent Tier, Interior
Laminate Accent Tier, Exterior
Table Post Premium Finish
Portal Power 1 Unit, Table Placement

SIN #711-16

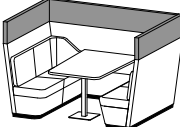
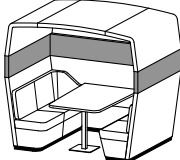
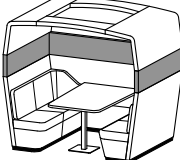
MODEL NUMBER	PRODUCT SPECIFICATIONS	FABRIC GRADES								
		COM	1	2	3	4	5	6	7	8
<p>Specify Interior Material Code, Followed by Exterior Material Code V = Veneer L = Laminate WB = Whiteboard</p>										
<p>6521-(-)-65TL</p> 	<p>Private Love Seat Unit with Integrated Table Non-Upholstered Accent Tier W 88¹/₂ D 60 H 56³/₄ Seat Height 18 Inside Seat Width 55¹/₄ Inside Seat Depth 19 24¹/₄ yds. 562 lbs. TB 133, add \$1164 List</p>	12172	13547	13878	14464	15050	15610	16196	16730	17316
<p>6522-(-)-65TL</p> 	<p>Private Love Seat Unit with Full Canopy and Integrated Table, Non-Upholstered Accent Tier W 88¹/₂ D 60 H 80¹/₄ Seat Height 18 Inside Seat Width 55¹/₄ Inside Seat Depth 19 35³/₄ yds. 637 lbs. TB 133, add \$1716 List</p>	14455	16483	16971	17834	18697	19523	20386	21175	22038
<p>6523-(-)-65TL</p> 	<p>Private Love Seat Unit with Open Canopy and Integrated Table, Non-Upholstered Accent Tier W 88¹/₂ D 60 H 80¹/₄ Seat Height 18 Inside Seat Width 55¹/₄ Inside Seat Depth 19 34 yds. 741 lbs. TB 133, add \$1632 List</p>	14514	16442	16906	17727	18549	19334	20155	20905	21726

OPTIONS (XXXX - REFERS TO LOVE SEAT MODEL NUMBER)

MODEL	DESCRIPTION	LIST	OPTIONAL ACCESSORIES	PAGE REFERENCE
XXXX-MB07	Moisture Barrier, Seats Only	290	Shelf	page 39
XXXX-LED2	LED Light (two fixtures, full canopy only)	500	Linking Table	page 40
XXXX-MR5	Monitor Ready Mounting (includes PB5 table-mounted power unit)	665	Cantilever Table	page 40
XXXX-PF03	Premium Finish, Table Post	110	Storage Cubby	page 41

FOR PLACEMENT BELOW SEATS AND/OR CENTER OF INTEGRATED TABLES

XXXX-PB1-S	Power Band 1 (one power, two USB), Silver	413
XXXX-PB1-W	Power Band 1 (one power, two USB), White	413
XXXX-PB2-S	Power Band 2 (dual power), Silver	322
XXXX-PB2-W	Power Band 2 (dual power), White	322
XXXX-PB3-S	Power Band 3 (dual power, two USB), Silver	429
XXXX-PB3-W	Power Band 3 (dual power, two USB), White	429

FOR INTEGRATED TABLES ONLY, CENTERED 5" FROM BACK

XXX-PP1	Portal Power 1 (one power, one data)	612
XXXX-PP2	Portal Power 2 (dual power)	542
XXXX-PP3	Portal Power 3 (one power, two USB)	643

NOTES:

- Fully upholstered seating models with black plinth base. Refer to page 3 for product details.
- When specifying electrical or over-head LED light fixture, cord exit grommet position must be specified as well as power source location, as applicable.

SPECIFY:

- Model number
- Upholstery selection
- Options, as applicable

ORDERING EXAMPLE:

#6532-LED2-PB1-S

60" D Love Seat, Full Canopy
Overhead LED Light
Power Band 1 Unit, Silver
Seat Placement

CO-OP
MEETING SPACES

designed by qdesign



SIN #711-16

MODEL NUMBER	PRODUCT SPECIFICATIONS	FABRIC GRADES								
		COM	1	2	3	4	5	6	7	8
6532 	60" D Booth with Full Canopy W 88 ¹ / ₂ D 60 H 80 ¹ / ₄ Seat Height 18 Inside Seat Width 60 Inside Seat Depth 19 34 yds. 496 lbs. TB 133, add \$1632 List	7859	9787	10251	11072	11894	12679	13500	14250	15071
6533 	60" D Booth with Open Canopy W 88 ¹ / ₂ D 60 H 80 ¹ / ₄ Seat Height 18 Inside Seat Width 60 Inside Seat Depth 19 32 ¹ / ₄ yds. 470 lbs. TB 133, add \$1548 List	7917	9746	10186	10965	11744	12489	13268	13979	14758
6534 	72" D Booth with Full Canopy W 88 ¹ / ₂ D 72 H 80 ¹ / ₄ Seat Height 18 Inside Seat Width 60 Inside Seat Depth 19 39 yds. 594 lbs. TB 133, add \$1872 List	9453	11665	12197	13139	14081	14982	15924	16784	17725
6535 	72" D Booth with Open Canopy W 88 ¹ / ₂ D 72 H 80 ¹ / ₄ Seat Height 18 Inside Seat Width 60 Inside Seat Depth 19 36 ¹ / ₄ yds. 582 lbs. TB 133, add \$1740 List	9390	11446	11941	12816	13692	14529	15404	16204	17079

OPTIONS (XXXX - REFERS TO BOOTH MODEL NUMBER)

MODEL	DESCRIPTION	LIST	OPTIONAL ACCESSORIES	PAGE REFERENCE
XXXX-MB07	Moisture Barrier, Seats Only (60" D Models)	290	Shelf	page 39
XXXX-MB08	Moisture Barrier, Seats Only (72" D Models)	340	Linking Table	page 40
XXXX-LED2	LED Light (two fixtures, full canopy only)	500	Cantilever Table	page 40
XXXX-SB2	Sandbags, Set of 6 (150 lbs. per seat)	700	Storage Cubby	page 41
			Meeting Tables	page 42

FOR PLACEMENT BELOW SEATS

XXXX-PB1-S	Power Band 1 (one power, two USB), Silver	413
XXXX-PB1-W	Power Band 1 (one power, two USB), White	413
XXXX-PB2-S	Power Band 2 (dual power), Silver	322
XXXX-PB2-W	Power Band 2 (dual power), White	322
XXXX-PB3-S	Power Band 3 (dual power, two USB), Silver	429
XXXX-PB3-W	Power Band 3 (dual power, two USB), White	429

CO-OP MEETING SPACES

designed by qdesign

NOTES:

- Seating models with accent tier. Refer to pages 3 and 5 for product details.
- Accent tier available in Maple, Walnut and White Oak veneer (-V), laminate (-L) and whiteboard material (-WB). Please specify code for interior and exterior material selections.
- Standard with black plinth base.
- When specifying electrical or over-head LED light fixture, cord exit grommet position must be specified as well as power source location, as applicable.

SPECIFY:

1. Model number
2. Accent tier finish, interior
3. Accent tier finish, exterior
4. Upholstery selection
5. Options, as applicable

ORDERING EXAMPLE:

#6533-V-WB-PB3-W

60" Love Seat w/Open Canopy Veneer Accent Tier, Interior Whiteboard Accent Tier, Exterior Power Band 3 Unit, White Seat Placement

SIN #711-16

MODEL NUMBER PRODUCT SPECIFICATIONS FABRIC GRADES

Specify Interior Material Code, Followed by Exterior Material Code

V = Veneer L = Laminate WB = Whiteboard

6532-(-)(-)

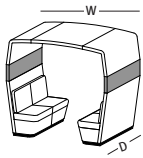

**60" D Booth with Full Canopy
Non-Upholstered Accent Tier**

W 88¹/₂ D 60 H 80¹/₄
Seat Height 18
Inside Seat Width 60
Inside Seat Depth 19
30 yds. 506 lbs.
TB 133, add \$1440 List

COM 1 2 3 4 5 6 7 8

9486 11187 11597 12321 13046 13739 14463 15125 15849

6533-(-)(-)

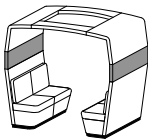

**60" D Booth with Open Canopy
Non-Upholstered Accent Tier**

W 88¹/₂ D 60 H 80¹/₄
Seat Height 18
Inside Seat Width 60
Inside Seat Depth 19
28¹/₄ yds. 480 lbs.
TB 133, add \$1356 List

9545 11147 11533 12215 12897 13550 14232 14855 15537

6534-(-)(-)

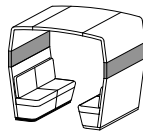

**72" D Booth with Full Canopy
Non-Upholstered Accent Tier**

W 88¹/₂ D 72 H 80¹/₄
Seat Height 18
Inside Seat Width 60
Inside Seat Depth 19
34¹/₂ yds. 604 lbs.
TB 133, add \$1656 List

11111 13068 13539 14372 15205 16002 16835 17596 18429

6535-(-)(-)

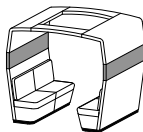

**72" D Booth with Open Canopy
Non-Upholstered Accent Tier**

W 88¹/₂ D 72 H 80¹/₄
Seat Height 18
Inside Seat Width 60
Inside Seat Depth 19
31³/₄ yds. 592 lbs.
TB 133, add \$1524 List

11049 12850 13283 14050 14817 15550 16317 17017 17784

OPTIONS (XXXX - REFERS TO BOOTH MODEL NUMBER)

MODEL	DESCRIPTION	LIST	OPTIONAL ACCESSORIES	PAGE REFERENCE
XXXX-MB07	Moisture Barrier, Seats Only (60" D Models)	290	Shelf	page 39
XXXX-MB08	Moisture Barrier, Seats Only (72" D Models)	340	Linking Table	page 40
XXXX-LED2	LED Light (two fixtures, full canopy only)	500	Cantilever Table	page 40
XXXX-SB2	Sandbags, Set of 6 (150 lbs. per seat)	700	Storage Cubby	page 41
			Meeting Tables	page 42

FOR PLACEMENT BELOW SEATS

XXXX-PB1-S	Power Band 1 (one power, two USB), Silver	412
XXXX-PB1-W	Power Band 1 (one power, two USB), White	412
XXXX-PB2-S	Power Band 2 (dual power), Silver	322
XXXX-PB2-W	Power Band 2 (dual power), White	322
XXXX-PB3-S	Power Band 3 (dual power, two USB), Silver	429
XXXX-PB3-W	Power Band 3 (dual power, two USB), White	429

NOTES:

- Fully upholstered canopy units with black plinth base. Refer to page 4 for product details.
- Table available in Maple, Walnut and White Oak veneer as well as laminate.
- Base available in standard and premium metal finishes.
- When specifying electrical or over-head LED light fixture, cord exit grommet position must be specified as well as power source location, as applicable.

SPECIFY:

- Model number
- Upholstery selection
- Table wood species
- Table wood finish
- Base finish
- Options, as applicable

ORDERING EXAMPLE:

#6543-3029-PP1
 60" D Open Canopy with
 30" Wide x 29" H Table
 Portal Power 1 Unit

CO-OP
MEETING SPACES

designed by qdesign

SIN #711-16

MODEL NUMBER	PRODUCT SPECIFICATIONS	FABRIC GRADES									
		TABLE HEIGHT	COM	1	2	3	4	5	6	7	8
6542-24(TABLE HEIGHT) 	60" D Stand-Alone Full Canopy with 24" Wide Table W 88 ¹ / ₂ D 60 H 80 ¹ / ₄ 23 yds. 461 lbs. average weight TB 133, add \$1104 List	27"	7376	8681	8995	9550	10105	10637	11192	11699	12255
		29"	7344	8649	8963	9518	10073	10605	11160	11667	12223
		39"	7622	8927	9241	9796	10351	10883	11438	11945	12501
6542-30(TABLE HEIGHT) 	60" D Stand-Alone Full Canopy with 30" Wide Table W 88 ¹ / ₂ D 60 H 80 ¹ / ₄ 23 yds. 475 lbs. average weight TB 133, add \$1104 List	27"	7900	9205	9519	10074	10629	11161	11716	12223	12779
		29"	7869	9174	9488	10043	10598	11130	11685	12192	12748
		39"	8145	9450	9764	10319	10874	11406	11961	12468	13024
6543-24(TABLE HEIGHT) 	60" D Stand-Alone Open Canopy with 24" Wide Table W 88 ¹ / ₂ D 60 H 80 ¹ / ₄ 21 ¹ / ₄ yds. 435 lbs. average weight TB 133, add \$1020 List	27"	7434	8639	8929	9443	9956	10447	10960	11428	11942
		29"	7404	8609	8899	9413	9926	10417	10930	11398	11912
		39"	7681	8886	9176	9690	10203	10694	11207	11675	12189
6543-30(TABLE HEIGHT) 	60" D Stand-Alone Open Canopy with 30" Wide Table W 88 ¹ / ₂ D 60 H 80 ¹ / ₄ 21 ¹ / ₄ yds. 449 lbs. average weight TB 133, add \$1020 List	27"	7958	9163	9453	9967	10480	10971	11484	11952	12466
		29"	7928	9133	9423	9937	10450	10941	11454	11922	12436
		39"	8204	9409	9699	10213	10726	11217	11730	12198	12712

TABLE LENGTHS (ALL WIDTHS)

27" High = 78" L
 29" High = 78¹/₂" L
 39" High = 81¹/₂" L

OPTIONS (XXXX - REFERS TO BOOTH MODEL NUMBER)

MODEL	DESCRIPTION	LIST	OPTIONAL ACCESSORIES	PAGE REFERENCE
XXXX-LED2	LED Light (two fixtures, full canopy only)	500	Shelf	page 39
XXXX-PF03	Premium Finish, Table Base	110	Linking Table	page 40
			Cantilever Table	page 40
			Storage Cubby	page 41
FOR TABLE PLACEMENT ONLY				
XXXX-PB1-S or XXXX-PB1-W	Power Band 1 (one power, two USB), Silver (-S) or White (-W)	413		
XXXX-PB2-S or XXXX-PB2-W	Power Band 2 (dual power), Silver (-S) or White (-W)	322		
XXXX-PB3-S or XXXX-PB3-W	Power Band 3 (dual power, two USB), Silver (-S) or White (-W)	429		
XXXX-PP1	Portal Power 1 (one power, one data)	612		
XXXX-PP2	Portal Power 2 (dual power)	542		
XXXX-PP3	Portal Power 3 (one power, two USB)	643		

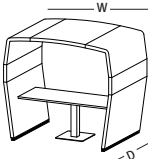
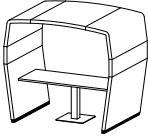
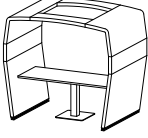
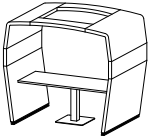
CO-OP MEETING SPACES

designed by qdesign

NOTES:

- Fully upholstered canopy units with table and black plinth base. Refer to page 4 for product details.
- Table available in Maple, Walnut and White Oak veneer as well as laminate.
- Base available in standard and premium metal finishes.
- When specifying electrical or overhead LED light fixture, cord exit grommet position must be specified as well as power source location, as applicable.

SPECIFY:

1. Model number
2. Upholstery selection
3. Table wood species
4. Table wood finish
5. Base finish
6. Options, as applicable

ORDERING EXAMPLE:

#6544-3029-PF03

72" D Open Canopy with
30" Wide x 29" H Table
Premium Base Finish

SIN #711-16

MODEL NUMBER	PRODUCT SPECIFICATIONS	FABRIC GRADES									
		TABLE HEIGHT	COM	1	2	3	4	5	6	7	8
6544-30(TABLE HEIGHT) 	72" D Stand-Alone Full Canopy with 30" Wide Table W 88 ¹ / ₂ D 72 H 80 ¹ / ₄ 27 yds. 547 lbs. average weight TB 133, add \$1296 List	27"	8725	10256	10625	11277	11929	12553	13205	13800	14452
		29"	8694	10225	10594	11246	11898	12522	13174	13769	14421
		39"	8971	10502	10871	11523	12175	12799	13451	14046	14698
6544-36(TABLE HEIGHT) 	72" D Stand-Alone Full Canopy with 36" Wide Table W 88 ¹ / ₂ D 72 H 80 ¹ / ₄ 27 yds. 562 lbs. average weight TB 133, add \$1296 List	27"	8760	10291	10660	11312	11964	12588	13240	13835	14487
		29"	8729	10260	10629	11281	11933	12557	13209	13804	14456
		39"	9006	10537	10906	11558	12210	12834	13486	14081	14733
6545-30(TABLE HEIGHT) 	72" D Stand-Alone Open Canopy with 30" Wide Table W 88 ¹ / ₂ D 72 H 80 ¹ / ₄ 24 ¹ / ₄ yds. 511 lbs. average weight TB 133, add \$1164 List	27"	8663	10038	10369	10955	11541	12101	12687	13221	13807
		29"	8631	10006	10337	10923	11509	12069	12655	13189	13775
		39"	8909	10284	10615	11201	11787	12347	12933	13467	14053
6545-36(TABLE HEIGHT) 	72" D Stand-Alone Open Canopy with 36" Wide Table W 88 ¹ / ₂ D 72 H 80 ¹ / ₄ 24 ¹ / ₄ yds. 526 lbs. average weight TB 133, add \$1164 List	27"	8698	10073	10404	10990	11576	12136	12722	13256	13842
		29"	8667	10042	10373	10959	11545	12105	12691	13225	13811
		39"	8943	10318	10649	11235	11821	12381	12967	13501	14087

TABLE LENGTHS (ALL WIDTHS)

27" High = 78" L
 29" High = 78¹/₂" L
 39" High = 81¹/₂" L

OPTIONS (XXXX - REFERS TO CANOPY MODEL NUMBER)

MODEL	DESCRIPTION	LIST	OPTIONAL ACCESSORIES	PAGE REFERENCE
XXXX-LED2	LED Light (two fixtures, full canopy only)	500	Shelf	page 39
XXXX-PF03	Premium Finish, Table Base	110	Linking Table	page 40
			Cantilever Table	page 40
			Storage Cubby	page 41
FOR TABLE PLACEMENT ONLY				
XXXX-PB1-S or XXXX-PB1-W	Power Band 1 (one power, two USB), Silver (-S) or White (-W)	413		
XXXX-PB2-S or XXXX-PB2-W	Power Band 2 (dual power), Silver (-S) or White (-W)	322		
XXXX-PB3-S or XXXX-PB3-W	Power Band 3 (dual power, two USB), Silver (-S) or White (-W)	429		
XXXX-PP1	Portal Power 1 (one power, one data)	612		
XXXX-PP2	Portal Power 2 (dual power)	542		
XXXX-PP3	Portal Power 3 (one power, two USB)	643		

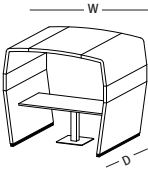
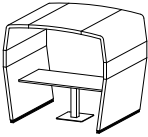
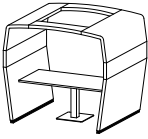
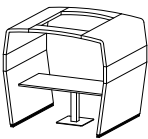
NOTES:

- Canopy units with table and accent tier black plinth base. Refer to pages 4-5 for product details.
- Standard with black plinth base.
- Accent tier available in Maple, Walnut and White Oak veneer (-V), laminate (-L) and whiteboard material (-WB). Please specify code for interior and exterior material selections.
- Table available in Maple, Walnut and White Oak veneer as well as laminate.
- Base available in standard and premium metal finishes.
- When specifying electrical or overhead LED light fixture, cord exit grommet position must be specified as well as power source location, as applicable.

SPECIFY:

1. Model number
2. Accent tier finish, interior
3. Accent tier finish, exterior
4. Upholstery selection
5. Table wood species
6. Table wood finish
7. Base finish
8. Options, as applicable

ORDERING EXAMPLE:

#6542-L-L-3039-LED2

60" D Full Canopy with
30" W x 39" H Table
Laminate Accent Tier, Interior
Laminate Accent Tier, Exterior
LED Lights

CO-OP
MEETING SPACES

designed by qdesign

SIN #711-16

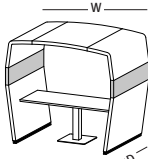
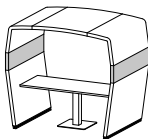
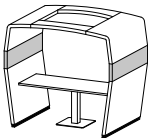
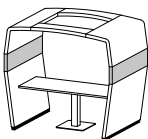
MODEL NUMBER	PRODUCT SPECIFICATIONS	FABRIC GRADES									
		TABLE HEIGHT	COM	1	2	3	4	5	6	7	8
Specify Interior Material Code, Followed by Exterior Material Code V = Veneer L = Laminate WB = Whiteboard											
6542-24-(-)(-)(TABLE HEIGHT)	60" D Stand-Alone Full Canopy Non-Upholstered Accent Tier with 24" Wide Table W 88 ¹ / ₂ D 60 H 80 ¹ / ₄ 19 yds. 471 lbs. average weight TB 133, add \$912 List	27"	9001	10079	10338	10797	11256	11695	12154	12573	13031
		29"	8971	10049	10308	10767	11226	11665	12124	12543	13001
		39"	9248	10326	10585	11044	11503	11942	12401	12820	13278
6542-30-(-)(-)(TABLE HEIGHT)	60" D Stand-Alone Full Canopy Non-Upholstered Accent Tier with 30" Wide Table W 88 ¹ / ₂ D 60 H 80 ¹ / ₄ 19 yds. 485 lbs. average weight TB 133, add \$912 List	27"	9525	10603	10862	11321	11780	12219	12678	13097	13555
		29"	9495	10573	10832	11291	11750	12189	12648	13067	13525
		39"	9772	10850	11109	11568	12027	12466	12925	13344	13802
6543-24-(-)(-)(TABLE HEIGHT)	60" D Stand-Alone Open Canopy Non-Upholstered Accent Tier with 24" Wide Table W 88 ¹ / ₂ D 60 H 80 ¹ / ₄ 17 ¹ / ₄ yds. 445 lbs. average weight TB 133, add \$828 List	27"	9061	10040	10275	10692	11108	11507	11923	12304	12720
		29"	9029	10008	10243	10660	11076	11475	11891	12272	12688
		39"	9307	10286	10521	10938	11354	11753	12169	12550	12966
6543-30-(-)(-)(TABLE HEIGHT)	60" D Stand-Alone Open Canopy Non-Upholstered Accent Tier with 30" Wide Table W 88 ¹ / ₂ D 60 H 80 ¹ / ₄ 17 ¹ / ₄ yds. 459 lbs. average weight TB 133, add \$828 List	27"	9585	10564	10799	11216	11632	12031	12447	12828	13244
		29"	9553	10532	10767	11184	11600	11999	12415	12796	13212
		39"	9832	10811	11046	11463	11879	12278	12694	13075	13491
TABLE LENGTHS (ALL WIDTHS) 27" High = 78" L 29" High = 78 ¹ / ₂ " L 39" High = 81 ¹ / ₂ " L											

OPTIONS (XXXX-REFERS TO CANOPY MODEL NUMBER)

MODEL	DESCRIPTION	LIST	OPTIONAL ACCESSORIES	PAGE REFERENCE
XXXX-LED2	LED Light (two fixtures, full canopy only)	500	Shelf Linking Table Cantilever Table Storage Cubby	page 39 page 40 page 40 page 41
	Refer to page 26 for electrical options			

CO-OP MEETING SPACES

designed by qdesign

NOTES:

- Canopy units with table and accent tier black plinth base. Refer to pages 4-5 for product details.
- Standard with black plinth base.
- Accent tier available in Maple, Walnut and White Oak veneer (-V), laminate (-L) and whiteboard material (-WB). Please specify code for interior and exterior material selections.
- Table available in Maple, Walnut and White Oak veneer as well as laminate.
- Base available in standard and premium metal finishes.
- When specifying electrical or overhead LED light fixture, cord exit grommet position must be specified as well as power source location, as applicable.

SPECIFY:

1. Model number
2. Accent tier finish, interior
3. Accent tier finish, exterior
4. Upholstery selection
5. Table wood species
6. Table wood finish
7. Base finish
8. Options, as applicable

ORDERING EXAMPLE:

#6545-V-V-3039-LED2
 72" D Open Canopy with
 30" W x 39" H Table
 Veneer Accent Tier, Interior
 Veneer Accent Tier, Exterior
 LED Lights

SIN #711-16

MODEL NUMBER PRODUCT SPECIFICATIONS FABRIC GRADES

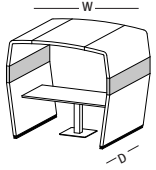
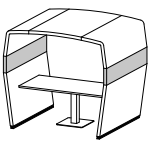
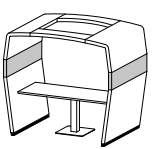
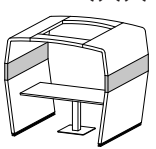
	TABLE HEIGHT	COM	FABRIC GRADES							
			1	2	3	4	5	6	7	8
Specify Interior Material Code, Followed by Exterior Material Code V = Veneer L = Laminate WB = Whiteboard										
6544-30-(-)(-)(TABLE HEIGHT) 			72" D Stand-Alone Full Canopy Non-Upholstered Accent Tier with 30" Wide Table W 88 ¹ / ₂ D 72 H 80 ¹ / ₄ 22 ¹ / ₂ yds. 557 lbs. average weight TB 133, add \$1080 List							
	27"	10383	11659	11966	12510	13053	13573	14116	14612	15156
	29"	10352	11628	11935	12479	13022	13542	14085	14581	15125
	39"	10630	11906	12213	12757	13300	13820	14363	14859	15403
6544-36-(-)(-)(TABLE HEIGHT) 			72" D Stand-Alone Full Canopy Non-Upholstered Accent Tier with 36" Wide Table W 88 ¹ / ₂ D 72 H 80 ¹ / ₄ 22 ¹ / ₂ yds. 572 lbs. average weight TB 133, add \$1080 List							
	27"	10418	11694	12001	12545	13088	13608	14151	14647	15191
	29"	10387	11663	11970	12514	13057	13577	14120	14616	15160
	39"	10664	11940	12247	12791	13334	13854	14397	14893	15437
6545-30-(-)(-)(TABLE HEIGHT) 			72" D Stand-Alone Open Canopy Non-Upholstered Accent Tier with 30" Wide Table W 88 ¹ / ₂ D 72 H 80 ¹ / ₄ 19 ³ / ₄ yds. 521 lbs. average weight TB 133, add \$948 List							
	27"	10320	11440	11710	12187	12664	13120	13597	14033	14509
	29"	10289	11409	11679	12156	12633	13089	13566	14002	14478
	39"	10568	11688	11958	12435	12912	13368	13845	14281	14757
6545-36-(-)(-)(TABLE HEIGHT) 			72" D Stand-Alone Open Canopy Non-Upholstered Accent Tier with 36" Wide Table W 88 ¹ / ₂ D 72 H 80 ¹ / ₄ 19 ³ / ₄ yds. 536 lbs. average weight TB 133, add \$948 List							
	27"	10356	11476	11746	12223	12700	13156	13633	14069	14545
	29"	10325	11445	11715	12192	12669	13125	13602	14038	14514
	39"	10602	11722	11992	12469	12946	13402	13879	14315	14791
TABLE LENGTHS (ALL WIDTHS) 27" High = 78" L 29" High = 78 ¹ / ₂ " L 39" High = 81 ¹ / ₂ " L										

OPTIONS (XXXX - REFERS TO CANOPY MODEL NUMBER)

MODEL	DESCRIPTION	LIST	OPTIONAL ACCESSORIES	PAGE REFERENCE
XXXX-LED2	LED Light (two fixtures, full canopy only)	500	Shelf Linking Table Cantilever Table Storage Cubby	page 39 page 40 page 40 page 41
	Refer to page 26 for electrical options			

NOTES:

- Fully upholstered wall-mount canopy units with, or without suspended table. Refer to page 5 for product details.
- Table available in Maple, Walnut and White Oak veneer as well as laminate.
- Standard with black plinth base.
- When specifying electrical or over-head LED light fixture, cord exit grommet position must be specified as well as power source location, as applicable.

SPECIFY:

- Model number
- Upholstery selection
- Table wood species
- Table wood finish
- Options, as applicable

ORDERING EXAMPLE:

#6552-2439

60" W Wall-Mount Full Canopy with 24" W x 39" H Table

CO-OP MEETING SPACES

designed by qdesign



SIN #711-16

MODEL NUMBER	PRODUCT SPECIFICATIONS	FABRIC GRADES							
		COM	1	2	3	4	5	6	7
<p>6552 60" W Wall-Mount Unit with Full Canopy, Panel Only W 60 D 66¹/₄ H 80¹/₄ 13¹/₄ yds. 196 lbs. TB 133, add \$636 List</p>	3062	3814	3995	4315	4635	4941	5261	5553	5873
<p>6553 60" W Wall-Mount Unit with Open Canopy, Panel Only W 60 D 66¹/₄ H 80¹/₄ 11¹/₂ yds. 170 lbs. TB 133, add \$552 List</p>	3127	3780	3937	4214	4492	4758	5035	5289	5567
<p>6554 72" W Wall-Mount Unit with Full Canopy, Panel Only W 72 D 66¹/₄ H 80¹/₄ 15³/₄ yds. 237 lbs. TB 133, add \$756 List</p>	3535	4429	4644	5024	5404	5768	6148	6496	6876
<p>6555 72" W Wall-Mount Unit with Open Canopy, Panel Only W 72 D 66¹/₄ H 80¹/₄ 13 yds. 201 lbs. TB 133, add \$624 List</p>	3479	4217	4394	4708	5022	5322	5636	5923	6237

OPTIONS (XXXX - REFERS TO WALL-MOUNT UNIT MODEL NUMBER)

MODEL	DESCRIPTION	LIST	OPTIONAL ACCESSORIES	PAGE REFERENCE
XXXX-2427	24" W x 61" L x 27" H Suspended Table (for 60" W models only)	1005		
XXXX-2429	24" W x 61 ¹ / ₂ " L x 29" H Suspended Table (for 60" W models only)	1005	Shelf	page 39
XXXX-2439	24" W x 63" L x 39" H Suspended Table (for 60" W models only)	1005	Linking Table	page 40
XXXX-3027	30" W x 61" L x 27" H Suspended Table (for 60" or 72" W models)	1629	Cantilever Table	page 40
XXXX-3029	30" W x 61 ¹ / ₂ " L x 29" H Suspended Table (for 60" or 72" W models)	1629	Storage Cubby	page 41
XXXX-3039	30" W x 63" L x 39" H Suspended Table (for 60" or 72" W models)	1629		
XXXX-3627	36" W x 61" L x 27" H Suspended Table (for 72" W models only)	1664		
XXXX-3629	36" W x 61 ¹ / ₂ " L x 29" H Suspended Table (for 72" W models only)	1664		
XXXX-3639	36" W x 63" L x 39" H Suspended Table (for 72" W models only)	1664		
XXXX-LED2	LED Light - only available with addition of suspended table (two fixtures, full canopy only)	500		
FOR TABLE PLACEMENT ONLY, CENTER PLACEMENT				
XXXX-PB1-S or XXXX-PB1-W	Power Band 1 (one power, two USB), Silver (-S) or White (-W)	413		
XXXX-PB2-S or XXXX-PB2-W	Power Band 2 (dual power), Silver (-S) or White (-W)	322		
XXXX-PB3-S or XXXX-PB3-W	Power Band 3 (dual power, two USB), Silver (-S) or White (-W)	429		
XXXX-PP1	Portal Power 1 (one power, one data)	612		
XXXX-PP2	Portal Power 2 (dual power)	542		
XXXX-PP3	Portal Power 3 (one power, two USB)	643		

CO-OP MEETING SPACES

designed by qdesign

NOTES:

- Wall-mount canopy units with accent tier and suspended table option. Refer to page 5 for product details.
- Accent tier available in Maple, Walnut and White Oak veneer (-V), laminate (-L) and whiteboard material (-WB). Please specify code for interior and exterior material selections.
- Table available in Maple, Walnut and White Oak veneer as well as laminate.
- Standard with black plinth base.
- When specifying electrical or over-head LED light fixture, cord exit grommet position must be specified as well as power source location, as applicable.

SPECIFY:

1. Model number
2. Accent tier finish, interior
3. Accent tier finish, exterior
4. Upholstery selection
5. Table wood species
6. Table wood finish
7. Options, as applicable

ORDERING EXAMPLE:

#6552-2439
60" W Wall-Mount Full Canopy with 24" W x 39" H Table

SIN #711-16

MODEL NUMBER PRODUCT SPECIFICATIONS FABRIC GRADES

Specify Interior Material Code, Followed by Exterior Material Code
V = Veneer L = Laminate WB = Whiteboard

6552-()-()

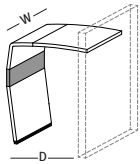

60" W Wall-Mount Unit with Full Canopy and Non-Upholstered Accent Tier, Panel Only
W 60 D 66¹/₄ H 80¹/₄
11¹/₄ yds. 201 lbs.
TB 133, add \$540 List

COM 1 2 3 4 5 6 7 8

3875 4513 4667 4939 5210 5470 5742 5990 6262

6553-()-()

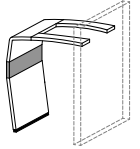

60" W Wall-Mount Unit with Open Canopy and Non-Upholstered Accent Tier, Panel Only
W 60 D 66¹/₄ H 80¹/₄
9¹/₂ yds. 175 lbs.
TB 133, add \$456 List

3940 4479 4609 4838 5068 5287 5517 5726 5955

6554-()-()

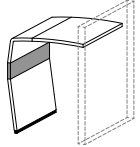

72" W Wall-Mount Unit with Full Canopy and Non-Upholstered Accent Tier, Panel Only
W 72 D 66¹/₄ H 80¹/₄
13¹/₂ yds. 242 lbs.
TB 133, add \$648 List

4363 5129 5313 5639 5965 6277 6603 6901 7227

6555-()-()

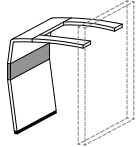

72" W Wall-Mount Unit with Open Canopy and Non-Upholstered Accent Tier, Panel Only
W 72 D 66¹/₄ H 80¹/₄
10³/₄ yds. 206 lbs.
TB 133, add \$516 List

4308 4918 5065 5324 5584 5832 6092 6329 6589

OPTIONS (XXXX - REFERS TO WALL-MOUNT UNIT MODEL NUMBER)

MODEL	DESCRIPTION	LIST	OPTIONAL ACCESSORIES	PAGE REFERENCE
XXXX-2427	24" W x 61" L x 27" H Suspended Table (for 60" W models only)	1005	Shelf	page 39
XXXX-2429	24" W x 61 ¹ / ₂ " L x 29" H Suspended Table (for 60" W models only)	1005	Linking Table	page 40
XXXX-2439	24" W x 63" L x 39" H Suspended Table (for 60" W models only)	1005	Cantilever Table	page 40
XXXX-3027	30" W x 61" L x 27" H Suspended Table (for 60" or 72" W models)	1629	Storage Cubby	page 41
XXXX-3029	30" W x 61 ¹ / ₂ " L x 29" H Suspended Table (for 60" or 72" W models)	1629		
XXXX-3039	30" W x 63" L x 39" H Suspended Table (for 60" or 72" W models)	1629		
XXXX-3627	36" W x 61" L x 27" H Suspended Table (for 72" W models only)	1664		
XXXX-3629	36" W x 61 ¹ / ₂ " L x 29" H Suspended Table (for 72" W models only)	1664		
XXXX-3639	36" W x 63" L x 39" H Suspended Table (for 72" W models only)	1664		
XXXX-LED2	LED Light - only available with addition of suspended table (two fixtures, full canopy only)	500		

Refer to page 29 for electrical options

NOTES:

- Fully upholstered wall-mount unit with love seat. Refer to page 5 for product details.
- Standard with black plinth base.
- When specifying electrical or over-head LED light fixture, cord exit grommet position must be specified as well as power source location, as applicable.

SPECIFY:

1. Model number
2. Upholstery selection
3. Options, as applicable

ORDERING EXAMPLE:

#6562-LED2

60" W Wall-Mount Love Seat
with Full Canopy
Overhead Light Fixture

**CO-OP
MEETING SPACES**

designed by qdesign

SIN #711-16

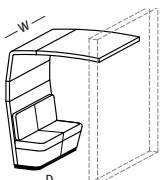
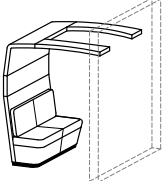
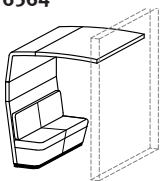
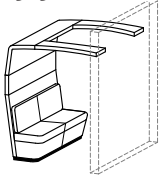
MODEL NUMBER	PRODUCT SPECIFICATIONS	FABRIC GRADES								
		COM	1	2	3	4	5	6	7	8
6562 	60" W Wall-Mount Seating Unit with Full Canopy W 60 D 66 ¹ / ₄ H 80 ¹ / ₄ Seat Height 18 Inside Seat Width 60 Inside Seat Depth 19 18 ³ / ₄ yds. 273 lbs. TB 133, add \$900 List	4365	5429	5685	6137	6590	7023	7476	7890	8342
6563 	60" W Wall-Mount Seating Unit with Open Canopy W 60 D 66 ¹ / ₄ H 80 ¹ / ₄ Seat Height 18 Inside Seat Width 60 Inside Seat Depth 19 17 yds. 247 lbs. TB 133, add \$816 List	4430	5394	5626	6037	6448	6840	7251	7626	8036
6564 	72" W Wall-Mount Seating Unit with Full Canopy W 72 D 66 ¹ / ₄ H 80 ¹ / ₄ Seat Height 18 Inside Seat Width 60 Inside Seat Depth 19 21 ³ / ₄ yds. 332 lbs. TB 133, add \$1044 List	5222	6456	6753	7278	7803	8306	8831	9310	9836
6565 	72" W Wall-Mount Seating Unit with Open Canopy W 72 D 66 ¹ / ₄ H 80 ¹ / ₄ Seat Height 18 Inside Seat Width 60 Inside Seat Depth 19 19 yds. 296 lbs. TB 133, add \$912 List	5166	6244	6503	6962	7421	7860	8319	8738	9196

OPTIONS (XXXX - REFERS TO SEATING UNIT MODEL NUMBER)

MODEL	DESCRIPTION	LIST	OPTIONAL ACCESSORIES PAGE REFERENCE
XXXX-MB03	Moisture Barrier, Seats Only (60" D Models)	145	Shelf page 39
XXXX-MB04	Moisture Barrier, Seats Only (72" D Models)	170	Linking Table page 40
XXXX-LED2	LED Light (two fixtures, full canopy only)	500	Cantilever Table page 40
XXXX-SB3	Sandbags, Set of 3 (150 lbs. per seat)	350	Storage Cubby page 41

FOR PLACEMENT BELOW SEATS

XXXX-PB1-S	Power Band 1 (one power, two USB), Silver	413
XXXX-PB1-W	Power Band 1 (one power, two USB), White	413
XXXX-PB2-S	Power Band 2 (dual power), Silver	322
XXXX-PB2-W	Power Band 2 (dual power), White	322
XXXX-PB3-S	Power Band 3 (dual power, two USB), Silver	429
XXXX-PB3-W	Power Band 3 (dual power, two USB), White	429

CO-OP MEETING SPACES

designed by qdesign

NOTES:

- Wall-mount unit with loveseat and accent tier.
- Accent tier available in Maple, Walnut and White Oak veneer (-V), laminate (-L) and whiteboard material (-WB). Please specify code for interior and exterior material selections.
- Standard with black plinth base.
- When specifying electrical or over-head LED light fixture, cord exit grommet position must be specified as well as power source location, as applicable.

SPECIFY:

1. Model number
2. Accent tier finish, interior
3. Accent tier finish, exterior
4. Upholstery selection
5. Options, as applicable

ORDERING EXAMPLE:

#6563-V-WB
60" W Wall-Mount Love Seat with Open Canopy Veneer Accent Tier, Interior Whiteboard Accent Tier, Exterior

SIN #711-16

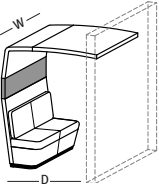
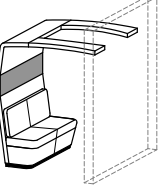
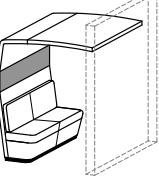
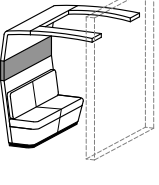
MODEL NUMBER	PRODUCT SPECIFICATIONS	FABRIC GRADES								
		COM	1	2	3	4	5	6	7	8
<p>Specify Interior Material Code, Followed by Exterior Material Code V = Veneer L = Laminate WB = Whiteboard</p>										
<p>6562-(-)(-)</p> 	<p>60" W Wall-Mount Seating Unit, Full Canopy Non-Upholstered Accent Tier W 60 D 66¹/₄ H 80¹/₄ Seat Height 18 Inside Seat Width 60 Inside Seat Depth 19 16³/₄ yds. 278 lbs. TB 133, add \$804 List</p>	5179	6129	6358	6762	7167	7554	7958	8328	8732
<p>6563-(-)(-)</p> 	<p>60" W Wall-Mount Seating Unit, Open Canopy Non-Upholstered Accent Tier W 60 D 66¹/₄ H 80¹/₄ Seat Height 18 Inside Seat Width 60 Inside Seat Depth 19 15 yds. 252 lbs. TB 133, add \$720 List</p>	5244	6095	6300	6662	7024	7371	7733	8064	8426
<p>6564-(-)(-)</p> 	<p>72" W Wall-Mount Seating Unit, Full Canopy Non-Upholstered Accent Tier W 72 D 66¹/₄ H 80¹/₄ Seat Height 18 Inside Seat Width 60 Inside Seat Depth 19 19¹/₂ yds. 338 lbs. TB 133, add \$936 List</p>	6052	7158	7424	7895	8366	8817	9288	9718	10188
<p>6565-(-)(-)</p> 	<p>72" W Wall-Mount Seating Unit, Open Canopy Non-Upholstered Accent Tier W 72 D 66¹/₄ H 80¹/₄ Seat Height 18 Inside Seat Width 60 Inside Seat Depth 19 16³/₄ yds. 302 lbs. TB 133, add \$804 List</p>	5996	6946	7175	7579	7984	8371	8775	9145	9549

OPTIONS (XXXX - REFERS TO SEATING UNIT MODEL NUMBER)

MODEL	DESCRIPTION	LIST	OPTIONAL ACCESSORIES	PAGE REFERENCE
XXXX-MB03	Moisture Barrier, Seats Only (60" D Models)	145	Shelf	page 39
XXXX-MB04	Moisture Barrier, Seats Only (72" D Models)	170	Linking Table	page 40
XXXX-LED2	LED Light (two fixtures, full canopy only)	500	Cantilever Table	page 40
XXX-SB3	Sandbags, Set of 3 (150 lbs. total)	350	Storage Cubby	page 41

Refer to page 31 for electrical options

NOTES:

- Fully upholstered seating unit. Refer to page 7 for product details.
- Standard with black plinth base.
- Power units available on front and side of seating units. Positioning must be specified in addition to cord exit grommet placement and power source location, as applicable.

SPECIFY:

1. Model number
2. Upholstery selection
3. Options, as applicable

ORDERING EXAMPLE:

#6503-PB1-W





60" W Private Love Seat
Power Band 1 Unit, White

CO-OP
MEETING SPACES

designed by qdesign

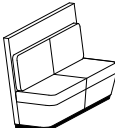

SIN #711-16

MODEL NUMBER	PRODUCT SPECIFICATIONS	FABRIC GRADES								
		COM	1	2	3	4	5	6	7	8
6502 	60" W Seating Unit W 60 D 27 ¹ / ₄ H 43 ¹ / ₂ Seat Height 18 Inside Seat Width 60 Inside Seat Depth 19 9 ¹ / ₄ yds. 162 lbs. TB 133, add \$444 List	2280	2805	2931	3155	3378	3592	3815	4019	4242
6503 	60" W Private Seating Unit W 60 D 27 ¹ / ₄ H 56 ³ / ₄ Seat Height 18 Inside Seat Width 60 Inside Seat Depth 19 11 ¹ / ₄ yds. 183 lbs. TB 133, add \$540 List	2790	3428	3582	3854	4125	4385	4657	4905	5177
6504 	72" W Seating Unit W 72 D 27 ¹ / ₄ H 43 ¹ / ₂ Seat Height 18 Inside Seat Width 60 Inside Seat Depth 19 10 ¹ / ₂ yds. 192 lbs. TB 133, add \$504 List	2820	3416	3559	3813	4066	4309	4562	4794	5048
6505 	72" W Private Seating Unit W 72 D 27 ¹ / ₄ H 56 ³ / ₄ Seat Height 18 Inside Seat Width 60 Inside Seat Depth 19 12 ³ / ₄ yds. 219 lbs. TB 133, add \$612 List	3377	4100	4274	4582	4890	5185	5493	5774	6082

OPTIONS (XXXX - REFERS TO SEATING UNIT MODEL NUMBER)

MODEL	DESCRIPTION	LIST	OPTIONAL ACCESSORIES PAGE REFERENCE
XXXX-MB03	Moisture Barrier, Seats Only (60" D Models)	145	Storage Cubby page 41
XXXX-MB04	Moisture Barrier, Seats Only (72" D Models)	170	Meeting Tables page 42
XXXX-SB3	Sandbags, Set of 3 (150 lbs. per seat)	350	

FOR PLACEMENT BELOW SEATS

XXXX-PB1-S	Power Band 1 (one power, two USB), Silver	413
XXXX-PB1-W	Power Band 1 (one power, two USB), White	413
XXXX-PB2-S	Power Band 2 (dual power), Silver	322
XXXX-PB2-W	Power Band 2 (dual power), White	322
XXXX-PB3-S	Power Band 3 (dual power, two USB), Silver	429
XXXX-PB3-W	Power Band 3 (dual power, two USB), White	429

CO-OP MEETING SPACES

designed by qdesign

NOTES:

- Upholstered seating unit with accent tier.
- Accent tier available in Maple, Walnut and White Oak veneer (-V), laminate (-L) and whiteboard material (-WB). Please specify code for interior and exterior material selections.
- Standard with black plinth base.
- Power units available on front and side of seating units. Positioning must be specified in addition to cord exit grommet placement and power source location, as applicable.

SPECIFY:

1. Model number
2. Accent tier finish, interior
3. Accent tier finish, exterior
4. Upholstery selection
5. Options, as applicable

ORDERING EXAMPLE:

#6503-V-L

60" W Private Love Seat
Veneer Accent Tier, Interior
Laminate Accent Tier, Exterior

SIN #711-16

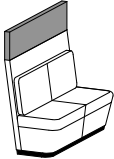
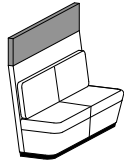
MODEL NUMBER	PRODUCT SPECIFICATIONS	FABRIC GRADES								
		COM	1	2	3	4	5	6	7	8
<p>Specify Interior Material Code, Followed by Exterior Material Code V = Veneer L = Laminate WB = Whiteboard</p>										
<p>6503-()-()</p> 	<p>60" W Private Seating Unit Non-Upholstered Tier W 60 D 27¹/₄ H 56³/₄ Seat Height 18 Inside Seat Width 60 Inside Seat Depth 19 9¹/₄ yds. 188 lbs. TB 133, add \$444 List</p>	3602	4127	4253	4477	4700	4914	5137	5341	5564
<p>6505-()-()</p> 	<p>72" W Private Seating Unit Non-Upholstered Tier W 72 D 27¹/₄ H 56³/₄ Seat Height 18 Inside Seat Width 60 Inside Seat Depth 19 10¹/₂ yds. 224 lbs. TB 133, add \$504 List</p>	4208	4804	4947	5201	5454	5697	5950	6182	6436

OPTIONS (XXXX - REFERS TO SEATING UNIT MODEL NUMBER)

MODEL	DESCRIPTION	LIST	OPTIONAL ACCESSORIES PAGE REFERENCE
XXXX-MB03	Moisture Barrier, Seats Only (60" D Models)	145	Storage Cubby page 41
XXXX-MB04	Moisture Barrier, Seats Only (72" D Models)	170	
XXXX-SB3	Sandbags, Set of 3 (150 lbs. per seat)	350	

FOR PLACEMENT BELOW SEATS

XXXX-PB1-S	Power Band 1 (one power, two USB), Silver	413
XXXX-PB1-W	Power Band 1 (one power, two USB), White	413
XXXX-PB2-S	Power Band 2 (dual power), Silver	322
XXXX-PB2-W	Power Band 2 (dual power), White	322
XXXX-PB3-S	Power Band 3 (dual power, two USB), Silver	429
XXXX-PB3-W	Power Band 3 (dual power, two USB), White	429

NOTES:

- Fully upholstered seating unit. Refer to page 7 for product details.
- Standard with black plinth base.
- Power units available on front and side of seating units. Positioning must be specified in addition to cord exit grommet placement and power source location, as applicable.

SPECIFY:

1. Model number
2. Upholstery selection
3. Options, as applicable

ORDERING EXAMPLE:

#6506-PB1-S

60" W Love Seat
Power Band 1 Unit, Silver
Below Seat Placement

CO-OP
MEETING SPACES

designed by qdesign

SIN #711-16

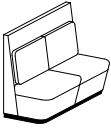
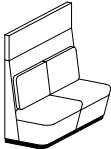
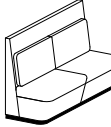
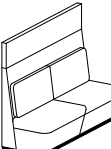
MODEL NUMBER	PRODUCT SPECIFICATIONS	FABRIC GRADES								
		COM	1	2	3	4	5	6	7	8
6506 	60" W Seating Unit, 90-Degree Back W 60 D 27 ¹ / ₄ H 43 ¹ / ₂ Seat Height 18 Inside Seat Width 60 Inside Seat Depth 19 9 ³ / ₄ yds. 172 lbs. TB 133, add \$468 List	2300	2853	2986	3222	3457	3683	3918	4133	4368
6507 	60" W Private Seating Unit, 90-Degree Back W 60 D 27 ¹ / ₄ H 56 ³ / ₄ Seat Height 18 Inside Seat Width 60 Inside Seat Depth 19 11 ³ / ₄ yds. 193 lbs. TB 133, add \$564 List	2809	3476	3636	3920	4204	4475	4759	5018	5302
6508 	72" W Seating Unit, 90-Degree Back W 72 D 27 ¹ / ₄ H 43 ¹ / ₂ Seat Height 18 Inside Seat Width 72 Inside Seat Depth 19 11 yds. 202 lbs. TB 133, add \$528 List	2842	3466	3616	3882	4148	4402	4667	4910	5176
6509 	72" W Private Seating Unit, 90-Degree Back W 60 D 27 ¹ / ₄ H 56 ³ / ₄ Seat Height 18 Inside Seat Width 72 Inside Seat Depth 19 13 ¹ / ₄ yds. 229 lbs. TB 133, add \$636 List	3400	4152	4333	4653	4973	5279	5599	5891	6211

OPTIONS (XXXX - REFERS TO SEATING UNIT MODEL NUMBER)

MODEL	DESCRIPTION	LIST
XXXX-MB03	Moisture Barrier, Seats Only (60" D Models)	145
XXXX-MB04	Moisture Barrier, Seats Only (72" D Models)	170

FOR PLACEMENT BELOW SEATS, AND/OR CENTER SIDE PANEL PLACEMENT

XXXX-PB1-S	Power Band 1 (one power, two USB), Silver	413
XXXX-PB1-W	Power Band 1 (one power, two USB), White	413
XXXX-PB2-S	Power Band 2 (dual power), Silver	322
XXXX-PB2-W	Power Band 2 (dual power), White	322
XXXX-PB3-S	Power Band 3 (dual power, two USB), Silver	429
XXXX-PB3-W	Power Band 3 (dual power, two USB), White	429

CO-OP MEETING SPACES

designed by qdesign

NOTES:

- Upholstered seating unit with accent tier.
- Accent tier available in Maple, Walnut and White Oak veneer (-V), laminate (-L) and whiteboard material (-WB). Please specify code for interior and exterior material selections.
- Standard with black plinth base.
- Power units available on front and side of seating units. Positioning must be specified in addition to cord exit grommet placement and power source location, as applicable.

SPECIFY:

1. Model number
2. Accent tier finish, interior
3. Accent tier finish, exterior
4. Upholstery selection
5. Options, as applicable

ORDERING EXAMPLE:

#6507-V-L

60" W Private Love Seat
Veneer Accent Tier, Interior
Laminate Accent Tier, Exterior

SIN #711-16

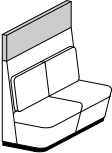
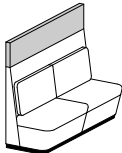
MODEL NUMBER	PRODUCT SPECIFICATIONS	FABRIC GRADES								
		COM	1	2	3	4	5	6	7	8
<p>Specify Interior Material Code, Followed by Exterior Material Code V = Veneer L = Laminate WB = Whiteboard</p>										
<p>6507-()-()</p> 	<p>60" W Private Seating Unit Non-Upholstered Tier, 90-Degree Back W 60 D 27¹/₄ H 56³/₄ Seat Height 18 Inside Seat Width 60 Inside Seat Depth 19 9³/₄ yds. 193 lbs. TB 133, add \$468 List</p>	3623	4176	4309	4545	4780	5006	5241	5456	5691
<p>6509-()-()</p> 	<p>72" W Private Seating Unit Non-Upholstered Tier 90-Degree Back W 60 D 27¹/₄ H 56³/₄ Seat Height 18 Inside Seat Width 72 Inside Seat Depth 19 11 yds. 229 lbs. TB 133, add \$528 List</p>	4229	4853	5003	5269	5535	5789	6054	6297	6563

OPTIONS (XXXX - REFERS TO SEATING UNIT MODEL NUMBER)

MODEL	DESCRIPTION	LIST
XXXX-MB03	Moisture Barrier, Seats Only (60" D Models)	145
XXXX-MB04	Moisture Barrier, Seats Only (72" D Models)	170
FOR PLACEMENT BELOW SEATS, AND/OR CENTER SIDE PANEL PLACEMENT		
XXXX-PB1-S	Power Band 1 (one power, two USB), Silver	413
XXXX-PB1-W	Power Band 1 (one power, two USB), White	413
XXXX-PB2-S	Power Band 2 (dual power), Silver	322
XXXX-PB2-W	Power Band 2 (dual power), White	322
XXXX-PB3-S	Power Band 3 (dual power, two USB), Silver	429
XXXX-PB3-W	Power Band 3 (dual power, two USB), White	429

NOTES:

- Fully upholstered seating unit. Refer to page 7 for product details.
- Standard with black plinth base.
- Power units available on front and side of seating units. Positioning must be specified in addition to cord exit grommet placement and power source location, as applicable.

SPECIFY:

1. Model number
2. Upholstery selection
3. Options, as applicable

ORDERING EXAMPLE:

#6566-PB1-S

60" W Love Seat
Power Band 1 Unit, Silver
Center Panel Placement

**CO-OP
MEETING SPACES**

designed by qdesign

SIN #711-16

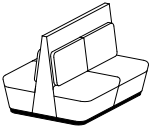
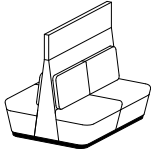
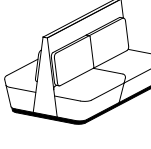
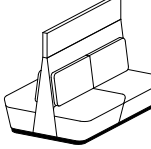
MODEL NUMBER	PRODUCT SPECIFICATIONS	FABRIC GRADES								
		COM	1	2	3	4	5	6	7	8
6566 	60" W Public Back-to-Back Seating Unit, 90-Degree Back W 60 D 51 ¹ / ₂ H 43 ¹ / ₂ Seat Height 18 Inside Seat Width 60 Inside Seat Depth 19 15 ¹ / ₄ yds. 314 lbs. TB 133, add \$732 List	4311	5176	5384	5753	6121	6473	6841	7178	7546
6567 	60" W Private Back-to-Back Seating Unit, 90-Degree Back W 60 D 51 ¹ / ₂ H 56 ³ / ₄ Seat Height 18 Inside Seat Width 60 Inside Seat Depth 19 17 ¹ / ₄ yds. 356 lbs. TB 133, add \$828 List	4821	5800	6035	6452	6868	7267	7683	8064	8480
6568 	72" W Public Back-to-Back Seating Unit, 90-Degree Back W 72 D 51 ¹ / ₂ H 43 ¹ / ₂ Seat Height 18 Inside Seat Width 72 Inside Seat Depth 19 17 ¹ / ₄ yds. 374 lbs. TB 133, add \$828 List	5208	6187	6422	6839	7255	7654	8070	8451	8867
6569 	72" W Private Back-to-Back Seating Unit, 90-Degree Back W 72 D 51 ¹ / ₂ H 56 ³ / ₄ Seat Height 18 Inside Seat Width 72 Inside Seat Depth 19 19 ¹ / ₂ yds. 428 lbs. TB 133, add \$936 List	5768	6874	7140	7611	8082	8533	9004	9434	9904

OPTIONS (XXXX - REFERS TO SEATING UNIT MODEL NUMBER)

MODEL	DESCRIPTION	LIST
XXXX-MB07	Moisture Barrier, Seats Only	290

FOR PLACEMENT BELOW SEATS, AND/OR CENTER SIDE PANEL PLACEMENT

XXXX-PB1-S	Power Band 1 (one power, two USB), Silver	413
XXXX-PB1-W	Power Band 1 (one power, two USB), White	413
XXXX-PB2-S	Power Band 2 (dual power), Silver	322
XXXX-PB2-W	Power Band 2 (dual power), White	322
XXXX-PB3-S	Power Band 3 (dual power, two USB), Silver	429
XXXX-PB3-W	Power Band 3 (dual power, two USB), White	429

CO-OP MEETING SPACES

designed by qdesign

NOTES:

- Upholstered seating unit with accent tier.
- Accent tier available in Maple, Walnut and White Oak veneer (-V), laminate (-L) and whiteboard material (-WB). Please specify code for interior and exterior material selections.
- Standard with black plinth base.
- Power units available on front and side of seating units. Positioning must be specified in addition to cord exit grommet placement and power source location, as applicable.

SPECIFY:

1. Model number
2. Accent tier finish, interior
3. Accent tier finish, exterior
4. Upholstery selection
5. Options, as applicable

ORDERING EXAMPLE:

#6569-V-L
72" W Private Back-to-Back Love Seat Veneer Accent Tier, Interior Laminate Accent Tier, Exterior

SIN #711-16

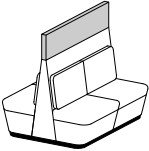
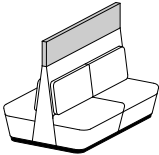
MODEL NUMBER	PRODUCT SPECIFICATIONS	FABRIC GRADES								
		COM	1	2	3	4	5	6	7	8
<p>Specify Interior Material Code, Followed by Exterior Material Code V = Veneer L = Laminate WB = Whiteboard</p>										
<p>6567-()-()</p> 	<p>60" W Private Back-to-Back Seating Unit, 90-Degree Back, Non-Upholstered Tier W 60 D 51¹/₂ H 56³/₄ Seat Height 18 Inside Seat Width 60 Inside Seat Depth 19 15¹/₄ yds. 356 lbs. TB 133, add \$732 List</p>	5635	6500	6708	7077	7445	7797	8165	8502	8870
<p>6569-()-()</p> 	<p>72" W Private Back-to-Back Seating Unit, Non-Upholstered Tier, 90-Degree Back W 72 D 51¹/₂ H 56³/₄ Seat Height 18 Inside Seat Width 72 Inside Seat Depth 19 17¹/₄ yds. 428 lbs. TB 133, add \$828 List</p>	6597	7576	7811	8228	8644	9043	9459	9840	10256

OPTIONS (XXXX - REFERS TO SEATING UNIT MODEL NUMBER)

MODEL	DESCRIPTION	LIST
XXXX-MB08	Moisture Barrier, Seats Only	340
FOR PLACEMENT BELOW SEATS		
XXXX-PB1-S	Power Band 1 (one power, two USB), Silver	413
XXXX-PB1-W	Power Band 1 (one power, two USB), White	413
XXXX-PB2-S	Power Band 2 (dual power), Silver	322
XXXX-PB2-W	Power Band 2 (dual power), White	322
XXXX-PB3-S	Power Band 3 (dual power, two USB), Silver	429
XXXX-PB3-W	Power Band 3 (dual power, two USB), White	429

NOTES:

- Shelf available on all tapered 60" and 72" wide/deep models.
- Available in Maple, Walnut and White Oak veneer as well as laminate selections. Refer to page 7 for additional information.
- Shelf support posts available in standard and premium metal finishes. Refer to page 1 for premium colors and additional information on shelf edge details.

SPECIFY:

1. Model number
2. Wood species, as applicable
3. Wood finish, as applicable
4. Post finish, as applicable

ORDERING EXAMPLE:

#65S2-PF02
30" High Shelf
Shelf Post Premium Finish

CO-OP
MEETING SPACES

designed by qdesign

SIN #711-16

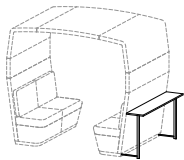
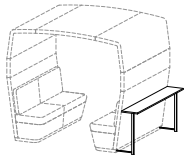
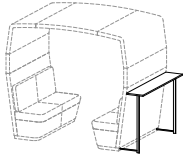
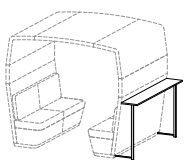
MODEL NUMBER	PRODUCT SPECIFICATIONS	VENEER OR LAMINATE
65S1-30 	30" H Shelf for 60" Width/Depth Units L 60 D 12 H 30 36 lbs.	843
65S2-30 	30" H Shelf for 72" Width/Depth Units L 72 D 12 H 30 42 lbs.	860
65S1-40 	40" H Shelf for 60" Width/Depth Units L 60 D 12 H 40 40 lbs.	952
65S2-40 	40" H Shelf for 72" Width/Depth Units L 72 D 12 H 40 46 lbs.	959

OPTIONS (XXXX - REFERS TO SHELF MODEL NUMBER)

MODEL	DESCRIPTION	LIST
XXXX-PF02	Premium Finish, Shelf Posts	80

CO-OP MEETING SPACES

designed by qdesign



SIN #711-16

NOTES:

- Linking and cantilever tables ordered separately.
- Linking table can be mounted between any tapered 60" wide and 72" wide unit. Refer to page 6 for product information.
- Cantilever table can be affixed to any tapered love seat and wall-mount unit. Refer to page 6 for product information.
- Tables available in Maple, Walnut and White Oak veneer as well as laminate.
- Power unit placement and cord exit location must be specified on applicable seating model.

SPECIFY:

1. Model number
2. Wood species
3. Wood finish
4. Base finish, as applicable
5. Options, as applicable

ORDERING EXAMPLE:

6580-307239

30 x 72 x 39 Linking Table

	MODEL NUMBER	VENEER OR LAMINATE	WEIGHT
LINKING TABLES			
29" Table Height			
	30" W x 60" L x 29" H	6580-306029	1656
	30" W x 72" L x 29" H	6580-307229	1900
	36" W x 60" L x 29" H	6580-366029	1888
	36" W x 72" L x 29" H	6580-367229	2151
39" Table Height			
	30" W x 60" L x 39" H	6580-306039	1656
	30" W x 72" L x 39" H	6580-307239	1900
	36" W x 60" L x 39" H	6580-366039	1888
	36" W x 72" L x 39" H	6580-367239	2151
CANTILEVER TABLES			
29" Table Height			
	30" W x 60" L x 29" H	6585-306029	2440
	30" W x 72" L x 29" H	6585-307229	2672
	36" W x 60" L x 29" H	6585-366029	2683
	36" W x 72" L x 29" H	6585-367229	2961
39" Table Height			
	30" W x 60" L x 39" H	6585-306039	2743
	30" W x 72" L x 39" H	6585-307239	2949
	36" W x 60" L x 39" H	6585-366039	2986
	36" W x 72" L x 39" H	6585-367239	3237

OPTIONS (XXXX - REFERS TO TABLE MODEL NUMBER)

MODEL	DESCRIPTION	LIST
XXXX-PF03	Premium Finish	110

FOR TABLE PLACEMENT ONLY

XXXX-PB1-S or XXXX-PB1-W	Power Band 1 (one power, two USB), Silver (-S) or White (-W)	413
XXXX-PB2-S or XXXX-PB2-W	Power Band 2 (dual power), Silver (-S) or White (-W)	322
XXXX-PB3-S or XXXX-PB3-W	Power Band 3 (dual power, two USB), Silver (-S) or White (-W)	429
XXXX-PP1	Portal Power 1 (one power, one data)	612
XXXX-PP2	Portal Power 2 (dual power)	542
XXXX-PP3	Portal Power 3 (one power, two USB)	643

NOTES:

- Storage cubby fits between tapered spaces of back-to-back, or side-to-side, love seat models. Refer to page 6 for details.
- Available in Maple, Walnut and White Oak veneer as well as laminate selections.
- Inside clearance, per cubby: 6" wide at the top, 10" wide at the bottom and 14¹/₄" high.

SPECIFY:

1. Model number
2. Wood species, as applicable
3. Wood finish, as applicable

ORDERING EXAMPLE:

#6586-60
60" Length Storage Cubby

CO-OP
MEETING SPACES

designed by qdesign

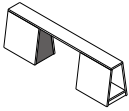
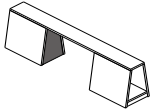

SIN #711-16

MODEL NUMBER	PRODUCT SPECIFICATIONS	VENEER OR LAMINATE
6586-60 	60" Length Storage Cubby L 60 D 12 H 18 42 lbs.	1354
6586-72 	72" Length Storage Cubby L 72 D 12 H 18 44 lbs.	1379

CO-OP MEETING SPACES

designed by qdesign



SIN #711-11

NOTES:

- Stand-alone tables available in Maple, Walnut and White Oak veneer as well as laminate.
- Metal base available in standard and premium finishes.
- Power units not available on free-standing tables.

SPECIFY:

1. Model number
2. Wood species
3. Wood finish
4. Base finish
5. Options, as applicable

ORDERING EXAMPLE:

#6590-306029-PF06

30 x 60 x 29 Arc Rectangle
Premium Base Finish

		MODEL NUMBER	VENEER OR LAMINATE	COLUMN DIMENSION	BASE DIMENSION	WEIGHT
	Arc Rectangle Top, 27" Height					
	30" W x 60" L x 27" H	6590-306027	3190	4 ³ / ₄ x 4 ³ / ₄	18x 18	135
	30" W x 72" L x 27" H	6590-307227	3435	4 ³ / ₄ x 4 ³ / ₄	18x 18	146
	36" W x 60" L x 27" H	6590-366027	3415	4 ³ / ₄ x 4 ³ / ₄	18x 18	146
	36" W x 72" L x 27" H	6590-367227	3690	4 ³ / ₄ x 4 ³ / ₄	18x 18	159
	42" W x 84" L x 27" H	6590-428427	4056	4 ³ / ₄ x 4 ³ / ₄	18x 18	188
	Arc Rectangle Top, 29" Height					
	30" W x 60" L x 29" H	6590-306029	3244	4 ³ / ₄ x 4 ³ / ₄	18x 18	147
	30" W x 72" L x 29" H	6590-307229	3443	4 ³ / ₄ x 4 ³ / ₄	18x 18	158
	36" W x 60" L x 29" H	6590-366029	3440	4 ³ / ₄ x 4 ³ / ₄	18x 18	158
	36" W x 72" L x 29" H	6590-367229	3696	4 ³ / ₄ x 4 ³ / ₄	18x 18	171
	42" W x 84" L x 29" H	6590-428429	4063	4 ³ / ₄ x 4 ³ / ₄	18x 18	200

OPTIONS (XXXX - REFERS TO TABLE MODEL NUMBER)

MODEL	DESCRIPTION	LIST
XXXX-PF06	Premium Finish, 2 Bases	220

MULTI-TONE UPHOLSTERY COMBINATIONS:

For upholstery fabric, panel fabric and/or vinyl combinations, refer to the pricing below:

- When combining **two** fabrics, add \$125 List per unit.
 - When combining **three** fabrics, add \$175 List per unit.
 - When combining **four or more** fabrics, add \$250 List per unit.
 - Excluding the back and seat cushions, fabric upholstery will always be railroaded.
 - **Canopy not available with polyurethane or vinyl upholstery.**
- For multiple seating models, please contact Customer Service for assistance with exact yardage requirements.
 - Note: Yardage amounts are based on fabric which is plain (i.e. non-directional), a full 54" wide and railroaded.

**CO-OP
MEETING SPACES**

designed by qdesign

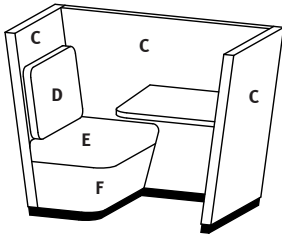

Public Single Work Module

Model	Location	COM Requirement
6514-65TA	C	Back Panel = 8 ¹ / ₂ yds.
6517-65TA	D	Back Cushion = 1 yd.
	E	Seat Cushion Top = 1 yd.
	F	Seat Cushion Bottom = 1 yd.

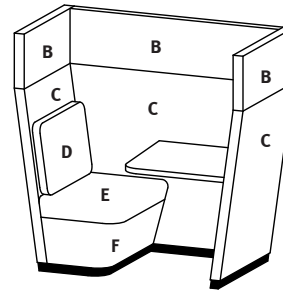

Private Single Work Module

Model	Location	COM Requirement
6515-65TA	B	Accent Tier = 4 yds.
6518-65TA	C	Back Panel = 8 ¹ / ₂ yds.
	D	Back Cushion = 1 yd.
	E	Seat Cushion Top = 1 yd.
	F	Seat Cushion Bottom = 1 yd.

Also applicable to models with veneer, laminate or whiteboard material as accent tier (B).

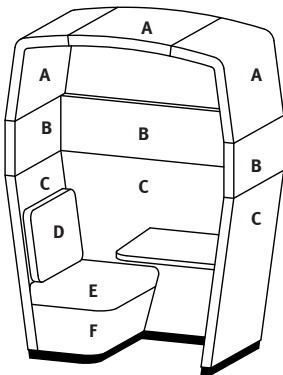

Private Single Work Module, Full Canopy

Model	Location	COM Requirement
6516-65TA	A	Canopy = 5 yds.
6519-65TA	B	Accent Tier = 4 yds.
	C	Back Panel = 8 ¹ / ₂ yds.
	D	Back Cushion = 1 yd.
	E	Seat Cushion Top = 1 yd.
	F	Seat Cushion Bottom = 1 yd.

Also applicable to models with veneer, laminate or whiteboard material as accent tier (B).

CO-OP MEETING SPACES

designed by qdesign

MULTI-TONE UPHOLSTERY COMBINATIONS:

For upholstery fabric, panel fabric and/or vinyl combinations, refer to the pricing below:

- When combining **two** fabrics, add \$125 List per unit.
 - When combining **three** fabrics, add \$175 List per unit.
 - When combining **four or more** fabrics, add \$250 List per unit.
 - Excluding the back and seat cushions, fabric upholstery will always be railroaded.
 - For multiple seating models, please contact Customer Service for assistance with exact yardage requirements.
- Note: Yardage amounts are based on fabric which is plain (i.e. non-directional), a full 54" wide and railroaded.

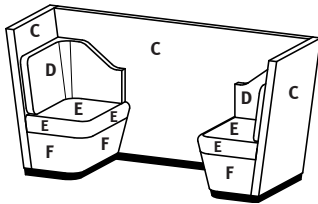

Public Lounge Unit

Model	Location	COM Requirement
6510	C	Back Panel = 9 ¹ / ₄ yds.
	D	Back Cushion = 2 yds.
	E	Seat Cushion Top = 2 yds.
	F	Seat Cushion Bottom = 2 yds.

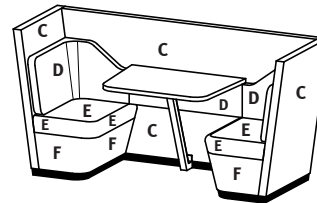

Public Lounge Unit with Integrated Table

Model	Location	COM Requirement
6510-65TS	C	Back Panel = 9 ¹ / ₄ yds.
	D	Back Cushion = 3 yds.
	E	Seat Cushion Top = 2 yds.
	F	Seat Cushion Bottom = 2 yds.

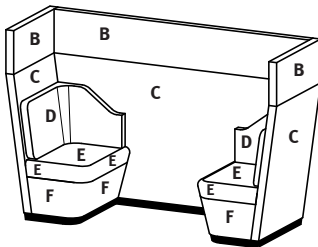

Private Lounge Unit

Model	Location	COM Requirement
6511	B	Upholstered Accent Tier = 4 ³ / ₄ yds.
	C	Back Panel = 9 ¹ / ₄ yds.
	D	Back Cushion = 2 yds.
	E	Seat Cushion Top = 2 yds.
	F	Seat Cushion Bottom = 2 yds.

Also applicable to models with veneer, laminate or whiteboard material as accent tier (B).

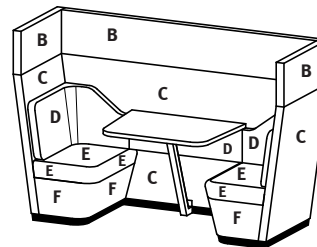

Private Lounge Unit with Integrated Table

Model	Location	COM Requirement
6511-65TS	B	Upholstered Accent Tier = 4 ³ / ₄ yds.
	C	Back Panel = 9 ¹ / ₄ yds.
	D	Back Cushion = 3 yds.
	E	Seat Cushion Top = 2 yds.
	F	Seat Cushion Bottom = 2 yds.

Also applicable to models with veneer, laminate or whiteboard material as accent tier (B).

MULTI-TONE UPHOLSTERY COMBINATIONS:

For upholstery fabric, panel fabric and/or vinyl combinations, refer to the pricing below:

- When combining **two** fabrics, add \$125 List per unit.
 - When combining **three** fabrics, add \$175 List per unit.
 - When combining **four or more** fabrics, add \$250 List per unit.
 - Excluding the back and seat cushions, fabric upholstery will always be railroaded.
 - **Canopy not available with polyurethane or vinyl upholstery.**
- For multiple seating models, please contact Customer Service for assistance with exact yardage requirements.
 - Note: Yardage amounts are based on fabric which is plain (i.e. non-directional), a full 54" wide and railroaded.

**CO-OP
MEETING SPACES**

designed by qdesign

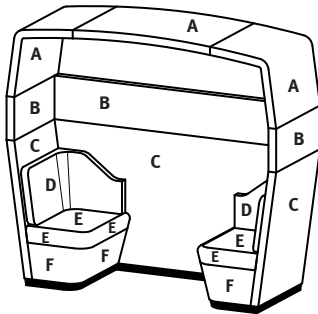

Private Lounge Unit with Full Canopy

Model	Location	COM Requirement
6512	A	Canopy = 5 ¹ / ₂ yds.
	B	Upholstered Accent Tier = 4 ³ / ₄ yds.
	C	Back Panel = 9 ¹ / ₄ yds.
	D	Back Cushion = 2 yds.
	E	Seat Cushion Top = 2 yds.
	F	Seat Cushion Bottom = 2 yds.

Also applicable to models with veneer, laminate or whiteboard material as accent tier (B).

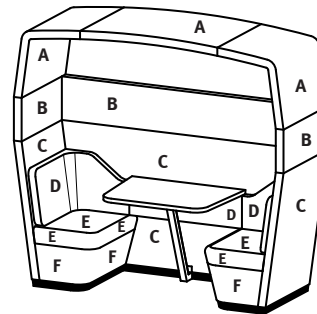

Private Lounge Unit with Full Canopy and Integrated Table

Model	Location	COM Requirement
6512-6515	A	Canopy = 5 ¹ / ₂ yds.
	B	Upholstered Accent Tier = 4 ³ / ₄ yds.
	C	Back Panel = 9 ¹ / ₄ yds.
	D	Back Cushion = 3 yds.
	E	Seat Cushion Top = 2 yds.
	F	Seat Cushion Bottom = 2 yds.

Also applicable to models with veneer, laminate or whiteboard material as accent tier (B).

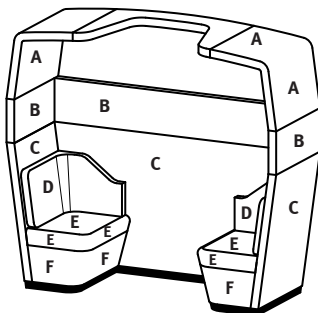

Private Lounge Unit with Partial Canopy

Model	Location	COM Requirement
6513	A	Canopy = 5 ¹ / ₂ yds.
	B	Upholstered Accent Tier = 4 ³ / ₄ yds.
	C	Back Panel = 9 ¹ / ₄ yds.
	D	Back Cushion = 2 yds.
	E	Seat Cushion Top = 2 yds.
	F	Seat Cushion Bottom = 2 yds.

Also applicable to models with veneer, laminate or whiteboard material as accent tier (B).

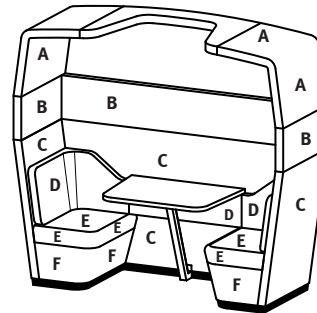

Private Lounge Unit with Partial Canopy and Integrated Table

Model	Location	COM Requirement
6513-6515	A	Canopy = 5 ¹ / ₂ yds.
	B	Upholstered Accent Tier = 4 ³ / ₄ yds.
	C	Back Panel = 9 ¹ / ₄ yds.
	D	Back Cushion = 3 yds.
	E	Seat Cushion Top = 2 yds.
	F	Seat Cushion Bottom = 2 yds.

Also applicable to models with veneer, laminate or whiteboard material as accent tier (B).

CO-OP MEETING SPACES

designed by qdesign

MULTI-TONE UPHOLSTERY COMBINATIONS:

For upholstery fabric, panel fabric and/or vinyl combinations, refer to the pricing below:

- When combining **two** fabrics, add \$125 List per unit.
 - When combining **three** fabrics, add \$175 List per unit.
 - When combining **four or more** fabrics, add \$250 List per unit.
 - Excluding the back and seat cushions, fabric upholstery will always be railroaded.
 - For multiple seating models, please contact Customer Service for assistance with exact yardage requirements.
- Note: Yardage amounts are based on fabric which is plain (i.e. non-directional), a full 54" wide and railroaded.

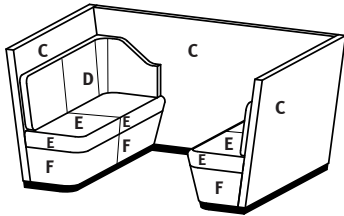

Public Love Seat Unit

Model	Location	COM Requirement
6520	C	Back Panel = 13 ¹ / ₄ yds.
	D	Back Cushion = 3 yds.
	E	Seat Cushion Top = 3 ¹ / ₂ yds.
	F	Seat Cushion Bottom = 3 ¹ / ₂ yds.

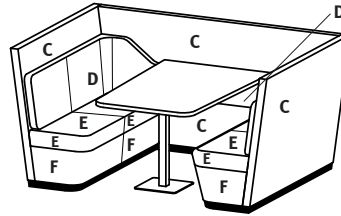

Public Love Seat Unit with Integrated Table

Model	Location	COM Requirement
6520-65TL	C	Back Panel = 13 ¹ / ₄ yds.
	D	Back Cushion = 3 yds.
	E	Seat Cushion Top = 3 ¹ / ₂ yds.
	F	Seat Cushion Bottom = 3 ¹ / ₂ yds.

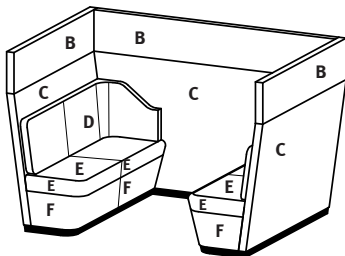

Private Love Seat Unit

Model	Location	COM Requirement
6521	B	Upholstered Accent Tier = 6 ³ / ₄ yds.
	C	Back Panel = 13 ¹ / ₄ yds.
	D	Back Cushion = 3 yds.
	E	Seat Cushion Top = 3 ¹ / ₂ yds.
	F	Seat Cushion Bottom = 3 ¹ / ₂ yds.

Also applicable to models with veneer, laminate or whiteboard material as accent tier (B).

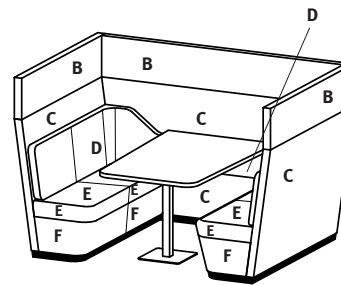

Private Love Seat Unit with Integrated Table

Model	Location	COM Requirement
6521-65TL	B	Upholstered Accent Tier = 6 ³ / ₄ yds.
	C	Back Panel = 13 ¹ / ₄ yds.
	D	Back Cushion = 3 yds.
	E	Seat Cushion Top = 3 ¹ / ₂ yds.
	F	Seat Cushion Bottom = 3 ¹ / ₂ yds.

Also applicable to models with veneer, laminate or whiteboard material as accent tier (B).

MULTI-TONE UPHOLSTERY COMBINATIONS:

For upholstery fabric, panel fabric and/or vinyl combinations, refer to the pricing below:

- When combining **two** fabrics, add \$125 List per unit.
 - When combining **three** fabrics, add \$175 List per unit.
 - When combining **four or more** fabrics, add \$250 List per unit.
 - Excluding the back and seat cushions, fabric upholstery will always be railroaded.
 - **Canopy not available with polyurethane or vinyl upholstery.**
- For multiple seating models, please contact Customer Service for assistance with exact yardage requirements.
 - Note: Yardage amounts are based on fabric which is plain (i.e. non-directional), a full 54" wide and railroaded.

**CO-OP
MEETING SPACES**

designed by qdesign

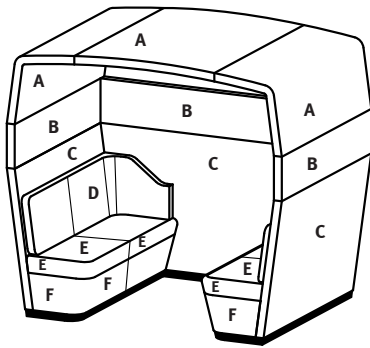

Private Love Seat Unit with Full Canopy

Model	Location	COM Requirement
6522	A	Canopy = 11 ¹ / ₂ yds.
	B	Upholstered Accent Tier = 6 ³ / ₄ yds.
	C	Back Panel = 13 ¹ / ₄ yds.
	D	Back Cushion = 3 yds.
	E	Seat Cushion Top = 3 ¹ / ₂ yds.
	F	Seat Cushion Bottom = 3 ¹ / ₂ yds.

Also applicable to models with veneer, laminate or whiteboard material as accent tier (B).

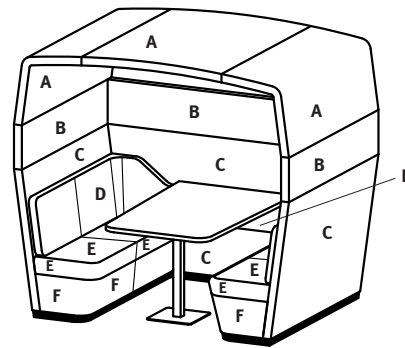

Private Love Seat Unit with Full Canopy and Integrated Table

Model	Location	COM Requirement
6522-65TL	A	Canopy = 11 ¹ / ₂ yds.
	B	Upholstered Accent Tier = 6 ³ / ₄ yds.
	C	Back Panel = 13 ¹ / ₄ yds.
	D	Back Cushion = 3 yds.
	E	Seat Cushion Top = 3 ¹ / ₂ yds.
	F	Seat Cushion Bottom = 3 ¹ / ₂ yds.

Also applicable to models with veneer, laminate or whiteboard material as accent tier (B).

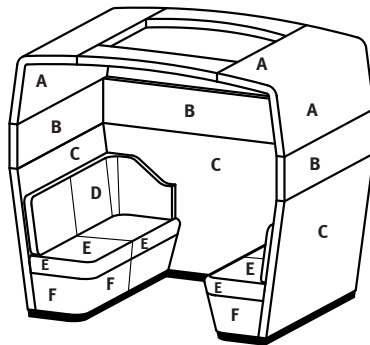

Private Love Seat Unit with Open Canopy

Model	Location	COM Requirement
6523	A	Canopy = 9 ³ / ₄ yds.
	B	Upholstered Accent Tier = 6 ³ / ₄ yds.
	C	Back Panel = 13 ¹ / ₄ yds.
	D	Back Cushion = 3 yds.
	E	Seat Cushion Top = 3 ¹ / ₂ yds.
	F	Seat Cushion Bottom = 3 ¹ / ₂ yds.

Also applicable to models with veneer, laminate or whiteboard material as accent tier (B).

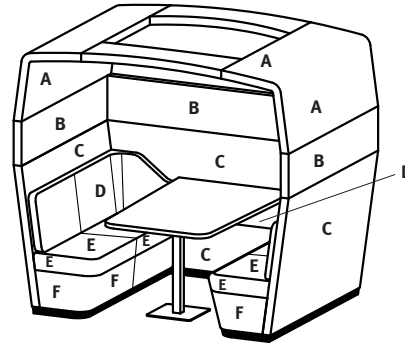

Private Love Seat Unit with Open Canopy and Integrated Table

Model	Location	COM Requirement
6523-65TL	A	Canopy = 9 ³ / ₄ yds.
	B	Upholstered Accent Tier = 6 ³ / ₄ yds.
	C	Back Panel = 13 ¹ / ₄ yds.
	D	Back Cushion = 3 yds.
	E	Seat Cushion Top = 3 ¹ / ₂ yds.
	F	Seat Cushion Bottom = 3 ¹ / ₂ yds.

Also applicable to models with veneer, laminate or whiteboard material as accent tier (B).

CO-OP MEETING SPACES

designed by qdesign

MULTI-TONE UPHOLSTERY COMBINATIONS:

For upholstery fabric, panel fabric and/or vinyl combinations, refer to the pricing below:

- When combining **two** fabrics, add \$125 List per unit.
 - When combining **three** fabrics, add \$175 List per unit.
 - When combining **four or more** fabrics, add \$250 List per unit.
 - Excluding the back and seat cushions, fabric upholstery will always be railroaded.
 - **Canopy not available with polyurethane or vinyl upholstery.**
- For multiple seating models, please contact Customer Service for assistance with exact yardage requirements.
 - Note: Yardage amounts are based on fabric which is plain (i.e. non-directional), a full 54" wide and railroaded.

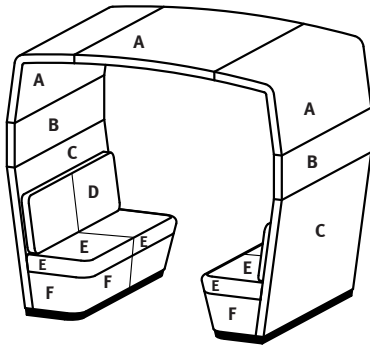

60" Depth Booth with Full Canopy

Model	Location	COM Requirement
6532	A	Canopy = 11 ¹ / ₂ yds.
	B	Upholstered Accent Tier = 4 yds.
	C	Back Panel = 8 yds.
	D	Back Cushion = 3 ¹ / ₂ yds.
	E	Seat Cushion Top = 3 ¹ / ₂ yds.
	F	Seat Cushion Bottom = 3 ¹ / ₂ yds.

Also applicable to models with veneer, laminate or whiteboard material as accent tier (B).

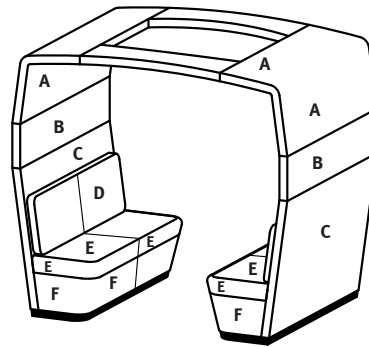

60" Depth Booth with Open Canopy

Model	Location	COM Requirement
6533	A	Canopy = 9 ³ / ₄ yds.
	B	Upholstered Accent Tier = 4 yds.
	C	Back Panel = 8 yds.
	D	Back Cushion = 3 ¹ / ₂ yds.
	E	Seat Cushion Top = 3 ¹ / ₂ yds.
	F	Seat Cushion Bottom = 3 ¹ / ₂ yds.

Also applicable to models with veneer, laminate or whiteboard material as accent tier (B).

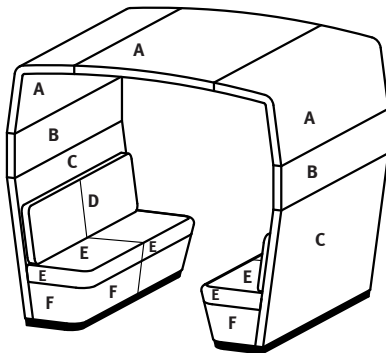

72" Depth Booth with Full Canopy

Model	Location	COM Requirement
6534	A	Canopy = 13 ¹ / ₂ yds.
	B	Upholstered Accent Tier = 4 ¹ / ₂ yds.
	C	Back Panel = 9 yds.
	D	Back Cushion = 4 yds.
	E	Seat Cushion Top = 4 yds.
	F	Seat Cushion Bottom = 4 yds.

Also applicable to models with veneer, laminate or whiteboard material as accent tier (B).

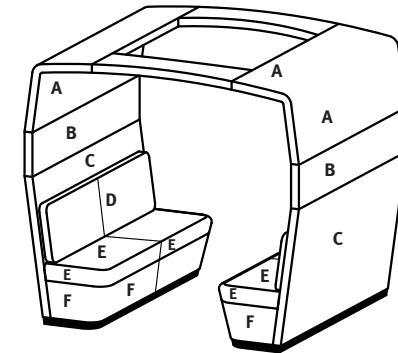

72" Depth Booth with Open Canopy

Model	Location	COM Requirement
6535	A	Canopy = 10 ³ / ₄ yds.
	B	Upholstered Accent Tier = 4 ¹ / ₂ yds.
	C	Back Panel = 9 yds.
	D	Back Cushion = 4 yds.
	E	Seat Cushion Top = 4 yds.
	F	Seat Cushion Bottom = 4 yds.

Also applicable to models with veneer, laminate or whiteboard material as accent tier (B).

MULTI-TONE UPHOLSTERY COMBINATIONS:

For upholstery fabric, panel fabric and/or vinyl combinations, refer to the pricing below:

- When combining **two** fabrics, add \$125 List per unit.
 - When combining **three** fabrics, add \$175 List per unit.
 - When combining **four or more** fabrics, add \$250 List per unit.
 - Excluding the back and seat cushions, fabric upholstery will always be railroaded.
 - **Canopy not available with polyurethane or vinyl upholstery.**
- For multiple seating models, please contact Customer Service for assistance with exact yardage requirements.
 - Note: Yardage amounts are based on fabric which is plain (i.e. non-directional), a full 54" wide and railroaded.

**CO-OP
MEETING SPACES**

designed by qdesign

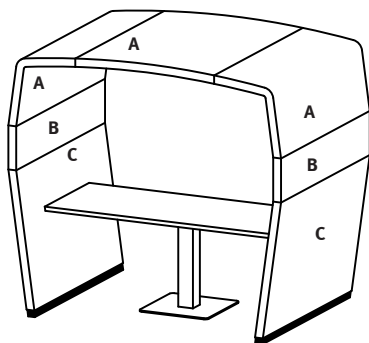

60" Depth Stand-Alone Full Canopy

Model	Location	COM Requirement
6542 with	A	Canopy = 11 ¹ / ₂ yds.
all table	B	Upholstered Accent Tier = 4 yds.
sizes	C	Back Panel = 7 ¹ / ₂ yds.

Also applicable to models with veneer, laminate or whiteboard material as accent tier (B).

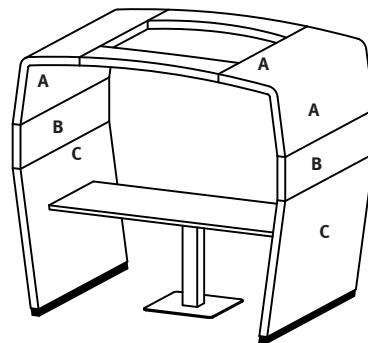

60" Depth Stand-Alone Open Canopy

Model	Location	COM Requirement
6543 with	A	Canopy = 9 ³ / ₄ yds.
all table	B	Upholstered Accent Tier = 4 yds.
sizes	C	Back Panel = 7 ¹ / ₂ yds.

Also applicable to models with veneer, laminate or whiteboard material as accent tier (B).

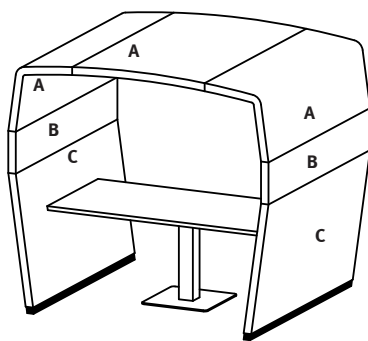

72" Depth Stand-Alone Full Canopy

Model	Location	COM Requirement
6544 with	A	Canopy = 13 ¹ / ₂ yds.
all table	B	Upholstered Accent Tier = 4 ¹ / ₂ yds.
sizes	C	Back Panel = 9 yds.

Also applicable to models with veneer, laminate or whiteboard material as accent tier (B).

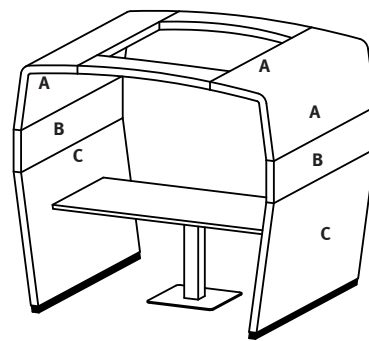

72" Depth Stand-Alone Open Canopy

Model	Location	COM Requirement
6545 with	A	Canopy = 10 ³ / ₄ yds.
all table	B	Upholstered Accent Tier = 4 ¹ / ₂ yds.
sizes	C	Back Panel = 9 yds.

Also applicable to models with veneer, laminate or whiteboard material as accent tier (B).

CO-OP MEETING SPACES

designed by qdesign

MULTI-TONE UPHOLSTERY COMBINATIONS:

For upholstery fabric, panel fabric and/or vinyl combinations, refer to the pricing below:

- When combining **two** fabrics, add \$125 List per unit.
- When combining **three** fabrics, add \$175 List per unit.
- When combining **four or more** fabrics, add \$250 List per unit.
- Excluding the back and seat cushions, fabric upholstery will always be railroaded.
- **Canopy not available with polyurethane or vinyl upholstery.**
- For multiple seating models, please contact Customer Service for assistance with exact yardage requirements.
- Note: Yardage amounts are based on fabric which is plain (i.e. non-directional), a full 54" wide and railroaded.

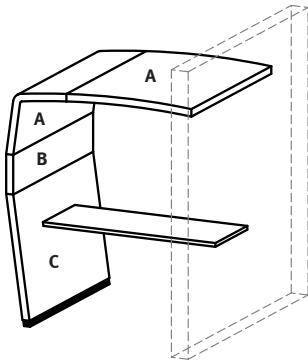

60" Wide Wall-Mount Unit with Full Canopy

Model	Location	COM Requirement
6552 and	A	Canopy = 7 ¹ / ₂ yds.
with all	B	Upholstered Accent Tier = 2 yds.
table sizes	C	Back Panel = 3 ³ / ₄ yds.

Also applicable to models with veneer, laminate or whiteboard material as accent tier (B).

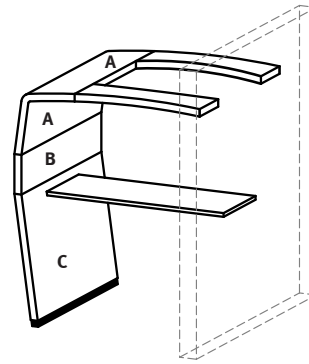

60" Wide Wall-Mount Unit with Open Canopy

Model	Location	COM Requirement
6553 and	A	Canopy = 5 ³ / ₄ yds.
with all	B	Upholstered Accent Tier = 2 yds.
table sizes	C	Back Panel = 3 ³ / ₄ yds.

Also applicable to models with veneer, laminate or whiteboard material as accent tier (B).

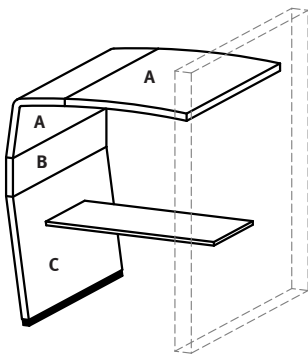

72" Wide Wall-Mount Unit with Full Canopy

Model	Location	COM Requirement
6554 and	A	Canopy = 9 yds.
with all	B	Upholstered Accent Tier = 2 ¹ / ₄ yds.
table sizes	C	Back Panel = 4 ¹ / ₂ yds.

Also applicable to models with veneer, laminate or whiteboard material as accent tier (B).

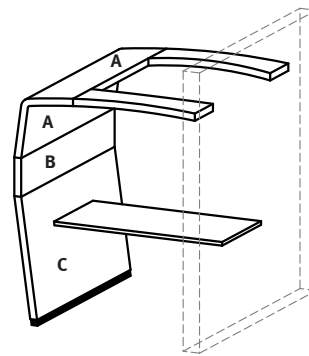

72" Wide Wall-Mount Unit with Open Canopy

Model	Location	COM Requirement
6555 and	A	Canopy = 6 ¹ / ₄ yds.
with all	B	Upholstered Accent Tier = 2 ¹ / ₄ yds.
table sizes	C	Back Panel = 4 ¹ / ₂ yds.

Also applicable to models with veneer, laminate or whiteboard material as accent tier (B).

MULTI-TONE UPHOLSTERY COMBINATIONS:

For upholstery fabric, panel fabric and/or vinyl combinations, refer to the pricing below:

- When combining **two** fabrics, add \$125 List per unit.
 - When combining **three** fabrics, add \$175 List per unit.
 - When combining **four or more** fabrics, add \$250 List per unit.
 - Excluding the back and seat cushions, fabric upholstery will always be railroaded.
 - **Canopy not available with polyurethane or vinyl upholstery.**
- For multiple seating models, please contact Customer Service for assistance with exact yardage requirements.
 - Note: Yardage amounts are based on fabric which is plain (i.e. non-directional), a full 54" wide and railroaded.

**CO-OP
MEETING SPACES**

designed by qdesign

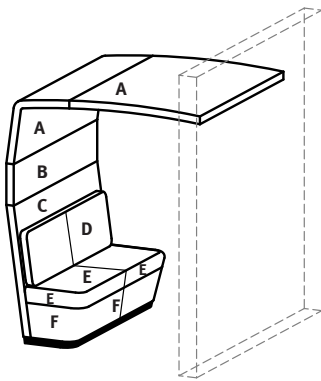

60" Wide Wall-Mount Seating Unit with Full Canopy

Model	Location	COM Requirement
6562	A	Canopy = 7 ¹ / ₂ yds.
	B	Upholstered Accent Tier = 2 yds.
	C	Back Panel = 4 yds.
	D	Back Cushion = 1 ³ / ₄ yds.
	E	Seat Cushion Top = 1 ³ / ₄ yds.
	F	Seat Cushion Bottom = 1 ³ / ₄ yds.

Also applicable to models with veneer, laminate or whiteboard material as accent tier (B).

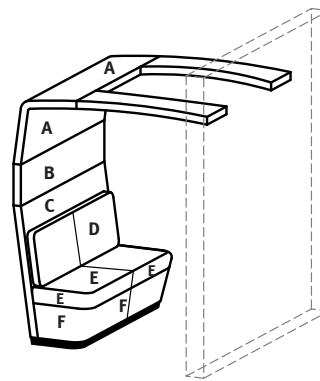

60" Wide Wall-Mount Seating Unit with Open Canopy

Model	Location	COM Requirement
6563	A	Canopy = 5 ³ / ₄ yds.
	B	Upholstered Accent Tier = 2 yds.
	C	Back Panel = 4 yds.
	D	Back Cushion = 1 ³ / ₄ yds.
	E	Seat Cushion Top = 1 ³ / ₄ yds.
	F	Seat Cushion Bottom = 1 ³ / ₄ yds.

Also applicable to models with veneer, laminate or whiteboard material as accent tier (B).

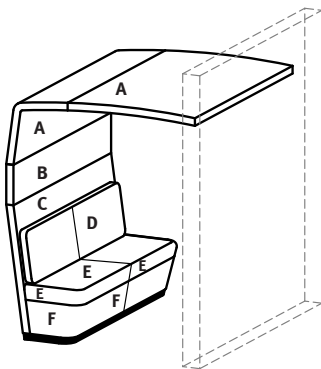

72" Wide Wall-Mount Seating Unit with Full Canopy

Model	Location	COM Requirement
6564	A	Canopy = 9 yds.
	B	Upholstered Accent Tier = 2 ¹ / ₄ yds.
	C	Back Panel = 4 ¹ / ₂ yds.
	D	Back Cushion = 2 yds.
	E	Seat Cushion Top = 2 yds.
	F	Seat Cushion Bottom = 2 yds.

Also applicable to models with veneer, laminate or whiteboard material as accent tier (B).

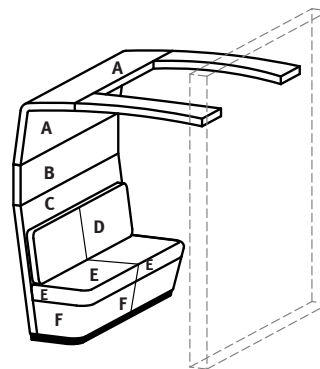

72" Wide Wall-Mount Seating Unit with Open Canopy

Model	Location	COM Requirement
6565	A	Canopy = 6 ¹ / ₄ yds.
	B	Upholstered Accent Tier = 2 ¹ / ₄ yds.
	C	Back Panel = 4 ¹ / ₂ yds.
	D	Back Cushion = 2 yds.
	E	Seat Cushion Top = 2 yds.
	F	Seat Cushion Bottom = 2 yds.

Also applicable to models with veneer, laminate or whiteboard material as accent tier (B).

CO-OP MEETING SPACES

designed by qdesign

MULTI-TONE UPHOLSTERY COMBINATIONS:

For upholstery fabric, panel fabric and/or vinyl combinations, refer to the pricing below:

- When combining **two** fabrics, add \$125 List per unit.
 - When combining **three** fabrics, add \$175 List per unit.
 - When combining **four or more** fabrics, add \$250 List per unit.
 - Excluding the back and seat cushions, fabric upholstery will always be railroaded.
 - For multiple seating models, please contact Customer Service for assistance with exact yardage requirements.
- Note: Yardage amounts are based on fabric which is plain (i.e. non-directional), a full 54" wide and railroaded.

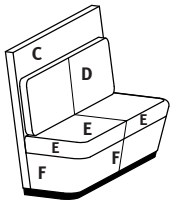

60" Wide Seating Unit

Model	Location	COM Requirement
6502	C	Back Panel = 4 yds.
	D	Back Cushion = 1 ³ / ₄ yds.
	E	Seat Cushion Top = 1 ³ / ₄ yds.
	F	Seat Cushion Bottom = 1 ³ / ₄ yds.

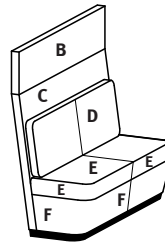

60" Wide Private Seating Unit

Model	Location	COM Requirement
6503	B	Upholstered Accent Tier = 2 yds.
	C	Back Panel = 4 yds.
	D	Back Cushion = 1 ³ / ₄ yds.
	E	Seat Cushion Top = 1 ³ / ₄ yds.
	F	Seat Cushion Bottom = 1 ³ / ₄ yds.

Also applicable to models with veneer, laminate or whiteboard material as accent tier (B).

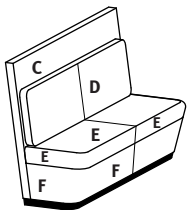

72" Wide Seating Unit

Model	Location	COM Requirement
6504	C	Back Panel = 4 ¹ / ₂ yds.
	D	Back Cushion = 2 yds.
	E	Seat Cushion Top = 2 yds.
	F	Seat Cushion Bottom = 2 yds.

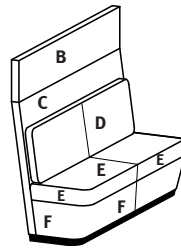

72" Wide Private Seating Unit

Model	Location	COM Requirement
6505	B	Upholstered Accent Tier = 2 ¹ / ₄ yds.
	C	Back Panel = 4 ¹ / ₂ yds.
	D	Back Cushion = 2 yds.
	E	Seat Cushion Top = 2 yds.
	F	Seat Cushion Bottom = 2 yds.

Also applicable to models with veneer, laminate or whiteboard material as accent tier (B).

MULTI-TONE UPHOLSTERY COMBINATIONS:

For upholstery fabric, panel fabric and/or vinyl combinations, refer to the pricing below:

- When combining **two** fabrics, add \$125 List per unit.
 - When combining **three** fabrics, add \$175 List per unit.
 - When combining **four or more** fabrics, add \$250 List per unit.
 - Excluding the back and seat cushions, fabric upholstery will always be railroaded.
 - **Canopy not available with polyurethane or vinyl upholstery.**
- For multiple seating models, please contact Customer Service for assistance with exact yardage requirements.
 - Note: Yardage amounts are based on fabric which is plain (i.e. non-directional), a full 54" wide and railroaded.

CO-OP
MEETING SPACES

designed by qdesign

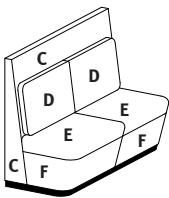

60" Wide Seating Unit, 90-Degree Back

Model	Location	COM Requirement
6506	C	Back Panel = 4 ¹ / ₂ yds.
	D	Back Cushion = 1 ³ / ₄ yds.
	E	Seat Cushion Top = 1 ³ / ₄ yds.
	F	Seat Cushion Bottom = 1 ³ / ₄ yds.

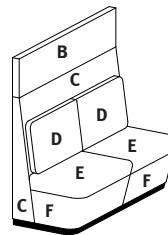

60" Wide Private Seating Unit, 90-Degree Back

Model	Location	COM Requirement
6507	B	Upholstered Accent Tier = 2 yds.
	C	Back Panel = 4 ¹ / ₂ yds.
	D	Back Cushion = 1 ³ / ₄ yds.
	E	Seat Cushion Top = 1 ³ / ₄ yds.
	F	Seat Cushion Bottom = 1 ³ / ₄ yds.

Also applicable to models with veneer, laminate or whiteboard material as accent tier (B).

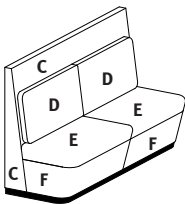

72" Wide Seating Unit, 90-Degree Back

Model	Location	COM Requirement
6508	C	Back Panel = 5 yds.
	D	Back Cushion = 2 yds.
	E	Seat Cushion Top = 2 yds.
	F	Seat Cushion Bottom = 2 yds.

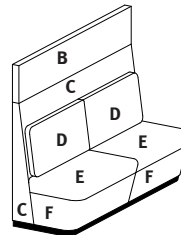

72" Wide Private Seating Unit, 90-Degree Back

Model	Location	COM Requirement
6509	B	Upholstered Accent Tier = 2 ¹ / ₄ yds.
	C	Back Panel = 5 yds.
	D	Back Cushion = 2 yds.
	E	Seat Cushion Top = 2 yds.
	F	Seat Cushion Bottom = 2 yds.

Also applicable to models with veneer, laminate or whiteboard material as accent tier (B).

CO-OP MEETING SPACES

designed by qdesign

MULTI-TONE UPHOLSTERY COMBINATIONS:

For upholstery fabric, panel fabric and/or vinyl combinations, refer to the pricing below:

- When combining **two** fabrics, add \$125 List per unit.
 - When combining **three** fabrics, add \$175 List per unit.
 - When combining **four or more** fabrics, add \$250 List per unit.
 - Excluding the back and seat cushions, fabric upholstery will always be railroaded.
 - For multiple seating models, please contact Customer Service for assistance with exact yardage requirements.
- Note: Yardage amounts are based on fabric which is plain (i.e. non-directional), a full 54" wide and railroaded.

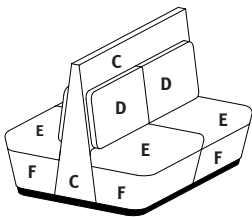

60" Wide Public Back-to-Back Seating Unit, 90-Degree Back

Model	Location	COM Requirement
6566	C	Back Panel = 4 ³ / ₄ yds.
	D	Back Cushion = 3 ¹ / ₂ yds.
	E	Seat Cushion Top = 3 ¹ / ₂ yds.
	F	Seat Cushion Bottom = 3 ¹ / ₂ yds.

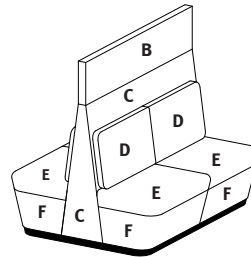

60" Wide Private Back-to-Back Seating Unit, 90-Degree Back

Model	Location	COM Requirement
6567	B	Upholstered Accent Tier = 2 yds.
	C	Back Panel = 4 ³ / ₄ yds.
	D	Back Cushion = 3 ¹ / ₂ yds.
	E	Seat Cushion Top = 3 ¹ / ₂ yds.
	F	Seat Cushion Bottom = 3 ¹ / ₂ yds.

Also applicable to models with veneer, laminate or whiteboard material as accent tier (B).

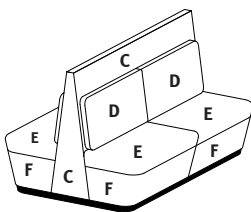

72" Wide Public Back-to-Back Seating Unit, 90-Degree Back

Model	Location	COM Requirement
6568	C	Back Panel = 5 ¹ / ₄ yds.
	D	Back Cushion = 4 yds.
	E	Seat Cushion Top = 4 yds.
	F	Seat Cushion Bottom = 4 yds.

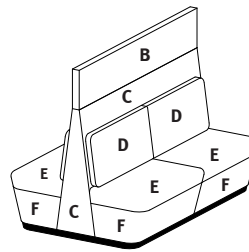

72" Wide Private Back-to-Back Seating Unit, 90-Degree Back

Model	Location	COM Requirement
6569	B	Upholstered Accent Tier = 2 ¹ / ₄ yds.
	C	Back Panel = 5 ¹ / ₄ yds.
	D	Back Cushion = 4 yds.
	E	Seat Cushion Top = 4 yds.
	F	Seat Cushion Bottom = 4 yds.

Also applicable to models with veneer, laminate or whiteboard material as accent tier (B).

CO-OP MEETING TABLES

designed by qdesign



PRODUCT FEATURES:

- Arc square, rectangle and arc rectangle table shapes available in 27", 29" and 39" heights.
- Depth options include: 24", 30", 36" and 42".
- Available in Maple, Walnut and White Oak veneer, in all standard finishes.
- For custom wood finishes, please add one-time upcharge of \$400 List per color per order.
- Laminate tops available in all Arcadia standard laminates.
- For custom laminates, add \$500 List per color per order. Pre-approval required, please contact Customer Service.
- Unless specified, veneer and laminate wood grain direction will run lengthwise on all rectangle top sizes.
- Table column dimensions: 4³/₄" x 4³/₄".
- Column and base plate available in standard and premium metal finishes.
- Tables not available with power units.

EDGE DETAIL:

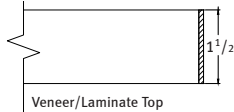

- For veneer tops, wood edge finish will match top finish color, unless otherwise specified.
- For laminate tops, self edge is standard, unless otherwise specified (laminate applied to edge).

STANDARD BASE FINISH COLORS:

#06 Charcoal Grey	#91 Chrome
#90 Metallic Silver	#95 Satin Black

PREMIUM BASE FINISH COLORS:

#07 Gold Shimmer	#83 Metallic Champagne
#08 Penny	#94 Cotton
#09 Brown Sugar	

CO-OP MEETING TABLES

designed by qdesign



NOTES:

- Available in Maple, Walnut and White Oak veneer as well as laminate.
- Metal base available in standard and premium finishes.

SPECIFY:

- Model number
- Wood species
- Wood finish
- Base Finish
- Options, as applicable

ORDERING EXAMPLE:

#6590-306029-PF06
30 x 60 x 29 Arc Rectangle Premium Base Finish

		MODEL NUMBER	VENEER OR LAMINATE	COLUMN DIMENSION	BASE DIMENSION	WEIGHT
	Arc Square Top, 27" Height					
	36" W x 36" L x 27" H	6590-363627	2064	4 ³ / ₄ x 4 ³ / ₄	22 x 22	77
	42" W x 42" L x 27" H	6590-424227	2327	4 ³ / ₄ x 4 ³ / ₄	22 x 22	91
	48" W x 48" L x 27" H	6590-484827	2624	4 ³ / ₄ x 4 ³ / ₄	22 x 22	107
	Arc Square Top, 29" Height					
	36" W x 36" L x 29" H	6590-363629	2079	4 ³ / ₄ x 4 ³ / ₄	22 x 22	86
	42" W x 42" L x 29" H	6590-424229	2343	4 ³ / ₄ x 4 ³ / ₄	22 x 22	100
	48" W x 48" L x 29" H	6590-484829	2639	4 ³ / ₄ x 4 ³ / ₄	22 x 22	116
	Arc Square Top, 39" Height					
	36" W x 36" L x 39" H	6590-363639	2382	4 ³ / ₄ x 4 ³ / ₄	22 x 22	95
	42" W x 42" L x 39" H	6590-424239	2645	4 ³ / ₄ x 4 ³ / ₄	22 x 22	109
	Arc Rectangle Top, 27" Height					
	30" W x 60" L x 27" H	6590-306027	3190	4 ³ / ₄ x 4 ³ / ₄	18 x 18	135
	30" W x 72" L x 27" H	6590-307227	3435	4 ³ / ₄ x 4 ³ / ₄	18 x 18	146
	36" W x 60" L x 27" H	6590-366027	3415	4 ³ / ₄ x 4 ³ / ₄	18 x 18	146
	36" W x 72" L x 27" H	6590-367227	3690	4 ³ / ₄ x 4 ³ / ₄	18 x 18	159
	42" W x 84" L x 27" H	6590-428427	4056	4 ³ / ₄ x 4 ³ / ₄	18 x 18	188
	Arc Rectangle Top, 29" Height					
	30" W x 60" L x 29" H	6590-306029	3244	4 ³ / ₄ x 4 ³ / ₄	18 x 18	147
	30" W x 72" L x 29" H	6590-307229	3443	4 ³ / ₄ x 4 ³ / ₄	18 x 18	158
	36" W x 60" L x 29" H	6590-366029	3440	4 ³ / ₄ x 4 ³ / ₄	18 x 18	158
	36" W x 72" L x 29" H	6590-367229	3696	4 ³ / ₄ x 4 ³ / ₄	18 x 18	171
	42" W x 84" L x 29" H	6590-428429	4063	4 ³ / ₄ x 4 ³ / ₄	18 x 18	200

OPTIONS (XXXX - REFERS TO TABLE MODEL NUMBER)

MODEL	DESCRIPTION	LIST
XXXX-PF03	Premium Finish, 1 Base	110
XXXX-PF06	Premium Finish, 2 Bases	220

NOTES:

- Available in Maple, Walnut and White Oak veneer as well as laminate.
- Metal base available in standard and premium finishes.

SPECIFY:

1. Model number
2. Wood species
3. Wood finish
4. Base Finish
5. Options, as applicable

ORDERING EXAMPLE:

#6590-246027-PF06
 24 x 60 x 27 Rectilinear Top
 Premium Base Finish

CO-OP
MEETING TABLES

designed by qdesign

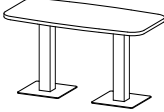
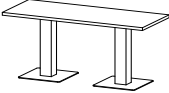
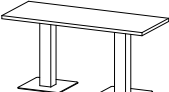
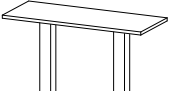

		MODEL NUMBER	VENEER OR LAMINATE	COLUMN DIMENSION	BASE DIMENSION	WEIGHT
	Arc Rectangle Top, 39" Table Height					
	30" W x 60" L x 39" H	6590-306039	3583	4 ³ / ₄ x 4 ³ / ₄	18 x 18	162
	30" W x 72" L x 39" H	6590-307239	3788	4 ³ / ₄ x 4 ³ / ₄	18 x 18	173
	36" W x 60" L x 39" H	6590-366039	3825	4 ³ / ₄ x 4 ³ / ₄	18 x 18	173
	36" W x 72" L x 39" H	6590-367239	4077	4 ³ / ₄ x 4 ³ / ₄	18 x 18	186
	42" W x 84" L x 39" H	6590-428439	4410	4 ³ / ₄ x 4 ³ / ₄	18 x 18	215
	Rectilinear Top, 27" Table Height					
	24" W x 60" L x 27" H	6591-246027	2913	4 ³ / ₄ x 4 ³ / ₄	18 x 18	89
	24" W x 72" L x 27" H	6591-247227	3126	4 ³ / ₄ x 4 ³ / ₄	18 x 18	98
	24" W x 84" L x 27" H	6591-248427	3337	4 ³ / ₄ x 4 ³ / ₄	18 x 18	106
	Rectilinear Top, 29" Table Height					
	24" W x 60" L x 29" H	6591-246029	2921	4 ³ / ₄ x 4 ³ / ₄	18 x 18	98
	24" W x 72" L x 29" H	6591-247229	3134	4 ³ / ₄ x 4 ³ / ₄	18 x 18	107
	24" W x 84" L x 29" H	6591-248429	3346	4 ³ / ₄ x 4 ³ / ₄	18 x 18	115
	Rectilinear Top, 39" Table Height					
	24" W x 60" L x 39" H	6591-246039	3306	4 ³ / ₄ x 4 ³ / ₄	18 x 18	110
	24" W x 72" L x 39" H	6591-247239	3517	4 ³ / ₄ x 4 ³ / ₄	18 x 18	119
	24" W x 84" L x 39" H	6591-248439	3729	4 ³ / ₄ x 4 ³ / ₄	18 x 18	127

OPTIONS (XXXX - REFERS TO TABLE MODEL NUMBER)

MODEL	DESCRIPTION	LIST
XXXX-PF06	Premium Finish, 2 Bases	220



CUBED OCCASIONAL TABLES

SIN #711-11

PRODUCT FEATURES:

- Tables manufactured in Maple.
- Custom sizes available, contact Customer Service for pricing.
- All tables feature veneer tops as standard. Laminate and Corian tops available.
- Laminate tops available in all Arcadia standard laminates.
- For custom laminates, add \$500 List per color per order. Pre-approval required, please contact Customer Service.
- For Corian top, specify “-CO” next to model number. Corian top is affixed to table top surface increasing overall table height by 1/2". Please note that a 1/8" reveal will be present.
- Corian top available in four standard colors. For non-standard colors, please contact Customer Service for pricing.
- Cubed tables available with or without fixed legs. Fixed leg dimensions: 1³/₄" Dia. x 3³/₄" H.
- Four fixed leg finishes: #90 Metallic Silver, #91 Chrome, #95 Satin Black and Beech Wood. For wood fixed legs, specify “-WL01” with finish selection and add \$110 List per table.
- 1/4" recessed plinth base, 1¹/₂" high, available in Maple veneer, chrome laminate and black laminate as well as all standard and custom laminates, please specify.
- All standard wood finishes available on Maple. For custom wood finishes, please add one-time upcharge of \$400 List per color per order.

CORIAN® COLORS:

Designer White
Linen
Rain Cloud
Witch Hazel

Corian® is a registered trademark of Dupont.

CUBED OCCASIONAL TABLES



SIN #711-11

NOTES:

- Tables manufactured in Maple.
- Custom sizes available, contact Customer Service for pricing.
- All tables feature veneer tops as standard. Laminate and Corian tops available.
- For Corian top, specify “-CO” next to model number. Corian top is affixed to table top surface increasing overall table height by 1/2" and features 1/8" reveal.
- Corian top available in four standard colors. For non-standard colors, please contact Customer Service for pricing.

SPECIFY:

1. Model number
2. Top finish
3. Body finish
4. Leg finish, as applicable

ORDERING EXAMPLE:

#257-181818-WL01
18" Cubed Table on Legs
Wood Legs

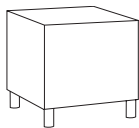
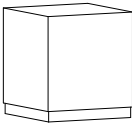
MODEL NUMBER	PRODUCT SPECIFICATIONS	TABLE TOP FINISH			
		MODEL NUMBER	VENEER OR LAMINATE	CORIAN (-CO)	WEIGHT
257 	Cubed Table on Legs 257 Series	257-181818	1351	1732	55
		257-242420	1444	2111	87
		257-302020	1564	2256	99
		257-303020	1655	2687	107
		257-363616	1856	3564	113
		257-482016	1839	2942	125
259 	Cubed Table on Plinth 259 Series	259-181818	1582	1953	60
		259-242420	1677	2324	92
		259-302020	1841	2517	103
		259-303020	1932	2938	110
		259-363616	2174	3827	119
		259-482016	2128	3201	130

CYLINDER OCCASIONAL TABLES



SIN #711-11

PRODUCT FEATURES:

- Tables manufactured in Maple. Custom sizes available, contact Customer Service for pricing.
- All tables feature veneer tops as standard. Laminate and Corian tops available.
- Laminate tops available in all Arcadia standard laminates.
- For custom laminates, add \$500 List per color per order. Pre-approval required, please contact Customer Service.
- For Corian top, specify “-CO” next to model number. Corian top is affixed to table top surface increasing overall table height by 1/2". Please note that a 1/8" reveal will be present.
- Corian top available in four standard colors. For non-standard colors, please contact Customer Service for pricing.
- **Table with laminate or Corian top, finish selection for table body must be specified.**
- Cylinder table available with or without fixed legs. Fixed leg dimensions: 1³/₄" Dia. x 3³/₄" H.
- Four fixed leg finishes: #90 Metallic Silver, #91 Chrome, #95 Satin Black and Beech Wood. For wood fixed legs, specify “-WL01” with finish selection and add \$110 List per table.
- 1/4" recessed plinth base, 1¹/₂" high, available in Maple veneer, chrome laminate and black laminate as well as all standard and custom laminates, please specify.
- All standard wood finishes available on Maple. For custom wood finishes, please add one-time upcharge of \$400 List per color per order.

CORIAN® COLORS:

Designer White
Linen
Rain Cloud
Witch Hazel

Corian® is a registered trademark of Dupont.

CYLINDER OCCASIONAL TABLES



SIN #711-11

NOTES:

- Tables manufactured in Maple.
- All tables feature veneer tops as standard. Laminate and Corian tops available.
- For Corian top, specify “-CO” next to model number. Corian top is affixed to table top surface increasing overall table height by 1/2" and features 1/8" reveal.
- **Table with laminate or Corian top, finish selection for table body must be specified.**
- Cylinder table available with or without fixed legs. Four fixed leg finishes: #90 Metallic Silver, #95 Satin Black, #91 Chrome and Wood.

SPECIFY:

1. Model number
2. Top finish
3. Body finish
4. Leg finish, as applicable

ORDERING EXAMPLE:

#112-1818-CO
18" Cylinder Table on Legs
Corian Top

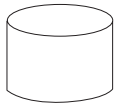
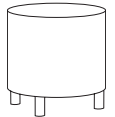
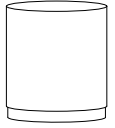
MODEL NUMBER	PRODUCT SPECIFICATIONS	TABLE TOP FINISH			
		MODEL NUMBER	VENEER OR LAMINATE	CORIAN (-CO)	WEIGHT
110 	Cylinder Table* 110 Series	110-1818	1182	1560	36
		110-2420	1350	2015	45
		110-2428	1494	2157	62
		110-3020	1775	2809	89
		110-3620	2208	3919	95
112 	Cylinder Table on Legs* 112 Series	112-1818	1253	1632	36
		112-2420	1420	2085	45
		112-2428	1567	2233	62
		112-3020	1847	2883	89
		112-3620	2278	3990	95
114 	Cylinder Table, Plinth Base* 114 Series	114-1818	1549	1920	40
		114-2420	1738	2387	50
		114-2428	1886	2534	65
		114-3020	2195	3203	75
		114-3620	2683	4339	100

*Table diameter sizes are not exact. Do not order glass or marble tops without obtaining a template from the factory.



DELEN MEETING TABLES

designed by ramsey madsen
and jim contoio

SIN #711-11

TABLE TOP FEATURES:

- Tables manufactured in Ash and Walnut wood species.
- 1^{1/2}" top thickness for round and rectangle tables, and 1^{1/4}" for wall-mount and sidebar tables.
- Plank-style available on sidebar and rectangle tables.
- Solid wood, veneer and laminate options.
- Rectangle tables 120" and over require two-piece tops.
- Veneer direction will run lengthwise on all tables.
- Available in standard Ash and Walnut wood finishes as listed below.
- For custom wood finishes, please add one-time upcharge of \$400 List per color per order.
- Laminate tops available in all Arcadia standard laminates.
- For custom laminates, add \$500 List per color per order. Pre-approval required, please contact Customer Service.
- Unless specified, laminate wood grain direction will run lengthwise on all rectangle table sizes.
- Solid wood top standard with matching edge.
- Table with veneer or laminate top, two edge finish options:
 - › Self-edge matched to veneer or laminate top selection.
 - › Exposed plywood edge matched to veneer or wood grain laminate top selection only. Solid color laminates, exposed plywood edge will have a clear-coat.
- When ordering in laminate, specify laminate manufacturer, color and pattern number.
- Custom table top sizes available, contact Customer Service for pricing.
- Plank-style tables include a 1/4" reveal between planks, finished to match top veneer or solid wood finish color. When ordered in laminate, reveal will match leg finish as standard, unless otherwise specified.
- Wall-mount and sidebar tables available with or without metal foot rest.
- Wall-mount units include hardware.
- Select technology options for top surface placement available on all sizes, please refer to pages 21-23 for options.
- All dimensions are nominal.

ASH WOOD FINISHES*:

#162 White Oak on Ash	#165 Kona Ash
#163 Walnut on Ash	#166 Smoky Umber Ash
#164 Cocoa Ash	#167 Slate Grey Ash

WALNUT WOOD FINISHES*:

#29 Natural Walnut
#30 Cinnamon Walnut
#35 Bourbon Walnut

*Please note that finishes will appear slightly darker on tables specified in solid wood.

DELEN MEETING TABLES

designed by ramsey madsen
and jim contoio



SIN #711-11

BASE FEATURES:

- Three table heights: 29", 36" and 42" (varies with top size).
- Solid Ash wood leg is 1¹/₂" thick and features integrated metal accent detail.
- Wall-mount and sidebar table legs are 3³/₄" wide, and placed in a straightforward position.
- Round and rectangle table legs are 4¹/₂" wide, and placed at a slight angle.
- Table tops specified in Ash solid wood, Ash veneer or wood grain laminate, legs will match as standard, unless otherwise specified.
- Table tops specified in Walnut solid wood, Walnut veneer or solid color laminate tops, please specify leg finish on Ash.
- For custom wood finishes, please add one-time upcharge of \$400 List per color per order.
- Metal accent detail available in all standard and premium finish selections.
- For premium finish, please refer to individual pages for upcharge and specification code.
- Tables 120" and over require three bases.
- Optional metal foot rest will match metal accent detail as standard (including premium finishes), unless otherwise specified.
- For custom metal finishes, please contact Customer Service for pricing.
- Bases feature adjustable glides for leveling purposes.
- Non-skid glides available for hard surface floors.
- Field-assembly required.

STANDARD METAL ACCENT FINISH COLORS:

#06 Charcoal Grey
#90 Metallic Silver
#95 Satin Black

PREMIUM METAL ACCENT FINISH COLORS:

#07 Gold Shimmer
#08 Penny
#09 Brown Sugar
#83 Metallic Champagne
#94 Cotton

BENCH FEATURES:

- Bench seats manufactured in Ash and Walnut wood species.
- 1¹/₂" top thickness.
- Solid wood, veneer and laminate options.
- Solid wood option standard with matching edge and features a 1/4" reveal to replicate plank-style design.
- Bench with veneer or laminate top, two edge finish options:
 - › Self-edge matched to veneer or laminate top selection.
 - › Exposed plywood edge matched to veneer or wood grain laminate top selection only. Solid color laminates, exposed plywood edge will have a clear-coat.
- When ordering in laminate, specify laminate manufacturer, color and pattern number.
- Legs manufactured in solid Ash wood and feature metal accent detail on leg interior.
- Benches specified in Ash solid wood, Ash veneer or wood grain laminate, legs will match as standard, unless otherwise specified.
- Benches specified in Walnut solid wood, Walnut veneer and solid color laminate, please specify leg finish on Ash.
- Metal accent available in all standard and premium finish selections.
- For custom metal accent finish, please contact Customer Service for pricing.
- Legs feature adjustable glides for leveling purposes.
- Non-skid glides available for hard surface floors.

NOTES:

- Wall-mount table tops manufactured in Ash and Walnut.
- Solid wood top standard with matching edge.
- Solid Ash wood legs feature integrated metal accent detail, in all standard and premium metal finishes.
- Optional metal footrest available and will match accent finish as standard.
- Refer to pages 21-23 for electrical unit options.

SPECIFY:

1. Model number
2. Wood species
3. Wood finish
4. Metal accent finish
5. Options, as applicable

ORDERING EXAMPLE:



#8710-207242-SW-FR01

20 x 72 x 42 Wall-Mount
Ash Solid Wood
Foot Rest

DELEN MEETING TABLES

designed by ramsey madsen
and jim contoio

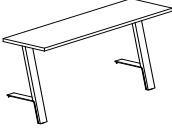
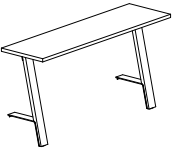
SIN #711-11

SOLID WOOD TOP	MODEL NUMBER	SOLID ASH WOOD	SOLID WALNUT WOOD	WEIGHT
 <p>Wall-Mount Table 29" Height</p> <p>20 W x 60 L x 29 H 20 W x 72 L x 29 H 20 W x 84 L x 29 H 20 W x 96 L x 29 H</p>	8710-206029-SW	2538	3351	90
	8710-207229-SW	2788	3681	103
	8710-208429-SW	3037	4009	116
	8710-209629-SW	3339	4408	129
 <p>Wall-Mount Table 36" Height</p> <p>20 W x 60 L x 36 H 20 W x 72 L x 36 H 20 W x 84 L x 36 H 20 W x 96 L x 36 H</p>	8710-206036-SW	2769	3656	93
	8710-207236-SW	3019	3985	106
	8710-208436-SW	3268	4314	119
	8710-209636-SW	3570	4713	132
 <p>Wall-Mount Table 42" Height</p> <p>20 W x 60 L x 42 H 20 W x 72 L x 42 H 20 W x 84 L x 42 H 20 W x 96 L x 42 H</p>	8710-206042-SW	2998	3958	96
	8710-207242-SW	3248	4288	109
	8710-208442-SW	3497	4616	122
	8710-209642-SW	3799	5015	135

OPTIONS (XXXX - REFERS TO TABLE MODEL NUMBER)

MODEL	DESCRIPTION	LIST
XXXX-FR01	Foot Rest	173
XXXX-PF05	Premium Metal Accent Finish	160

DELEN MEETING TABLES

designed by ramsey madsen
and jim contoio

NOTES:

- Wall-mount table tops manufactured in Ash and Walnut.
- Veneer or laminate top available with self-edge or exposed plywood edge options.
- Solid Ash wood legs feature integrated metal accent detail, in all standard and premium metal finishes.
- 120" and 144" length tables feature two-piece tops and three bases.
- Optional metal footrest available and will match accent finish as standard.
- Refer to pages 21-23 for electrical unit options.

SPECIFY:

1. Model number
2. Wood species
3. Edge detail
4. Wood finish
5. Metal accent finish
6. Options, as applicable

ORDERING EXAMPLE:

#8713-208429-EP-PF05

20 x 84 x 29 Wall-Mount
Ash Veneer
Exposed Edge
Premium Metal Finish

SIN #711-11

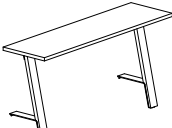
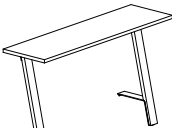
VENEER/LAMINATE TOP	MODEL NUMBER	ASH VENEER OR LAMINATE WITH SELF EDGE (-SE)	ASH VENEER OR LAMINATE WITH EXPOSED EDGE (-EP)	WALNUT VENEER WITH SELF EDGE (-SE)	WALNUT VENEER WITH EXPOSED EDGE (-EP)	WEIGHT
 <p>Wall-Mount Table 29" Height 20 W x 60 L x 29 H 20 W x 72 L x 29 H 20 W x 84 L x 29 H 20 W x 96 L x 29 H 20 W x 120 L x 29 H 20 W x 144 L x 29 H</p>	8713-206029-(-)	2444	2444	2713	2713	75
	8713-207229-(-)	2651	2651	2943	2943	85
	8713-208429-(-)	2776	2776	3081	3081	96
	8713-209629-(-)	2884	2884	3202	3202	106
	8713-2012029-(-)	4487	4487	4982	4982	160
	8713-2014429-(-)	4677	4677	5192	5192	186
 <p>Wall-Mount Table 36" Height 20 W x 60 L x 36 H 20 W x 72 L x 36 H 20 W x 84 L x 36 H 20 W x 96 L x 36 H 20 W x 120 L x 36 H 20 W x 144 L x 36 H</p>	8713-206036-(-)	2675	2675	2970	2970	78
	8713-207236-(-)	2882	2882	3199	3199	88
	8713-208436-(-)	3007	3007	3337	3337	99
	8713-209636-(-)	3115	3115	3458	3458	109
	8713-2012036-(-)	4834	4834	5366	5366	164
	8713-2014436-(-)	5024	5024	5577	5577	190
 <p>Wall-Mount Table 42" Height 20 W x 60 L x 42 H 20 W x 72 L x 42 H 20 W x 84 L x 42 H 20 W x 96 L x 42 H 20 W x 120 L x 42 H 20 W x 144 L x 42 H</p>	8713-206042-(-)	2904	2904	3224	3224	81
	8713-207242-(-)	3111	3111	3453	3453	91
	8713-208442-(-)	3236	3236	3591	3591	102
	8713-209642-(-)	3344	3344	3712	3712	112
	8713-2012042-(-)	5177	5177	5747	5747	168
	8713-2014442-(-)	5367	5367	5958	5958	194

OPTIONS (XXXX - REFERS TO TABLE MODEL NUMBER)

MODEL	DESCRIPTION	LIST
XXXX-FR01	Foot Rest, 1-piece top	173
XXXX-FR02	Foot Rest, 2-piece top	346
XXXX-PF05	Premium Metal Accent Finish, 1-piece top	160
XXXX-PF06	Premium Metal Accent Finish, 2-piece top	220

NOTES:

- Sidebar tables manufactured in Ash and Walnut.
- Solid wood top standard with matching edge.
- Solid Ash wood legs feature integrated metal accent detail, in all standard and premium metal finishes.
- Optional metal footrest available and will match accent finish as standard.
- Refer to pages 21-23 for electrical unit options.

SPECIFY:

1. Model number
2. Wood species
3. Wood finish
4. Metal accent finish
5. Options, as applicable

ORDERING EXAMPLE:

#8721-247242-SW-FR03







24 x 72 x 42 Sidebar
Ash Solid Wood
Foot Rest

DELEN

MEETING TABLES

designed by ramsey madsen
and jim contoio

SIN #711-11

SOLID WOOD TOP - PLANK STYLE	MODEL NUMBER	SOLID ASH WOOD	SOLID WALNUT WOOD	WEIGHT
 <p>Sidebar Table, 24" Wide 29" Height</p> <p>24 W x 60 L x 29 H 24 W x 72 L x 29 H 24 W x 84 L x 29 H 24 W x 96 L x 29 H</p>	8721-246029-SW	3558	4697	125
	8721-247229-SW	3810	5029	139
	8721-248429-SW	4119	5437	155
	8721-249629-SW	4482	5916	173
 <p>Sidebar Table, 24" Wide 36" Height</p> <p>24 W x 60 L x 36 H 24 W x 72 L x 36 H 24 W x 84 L x 36 H 24 W x 96 L x 36 H</p>	8721-246036-SW	4179	5517	130
	8721-247236-SW	4503	5945	144
	8721-248436-SW	4883	6445	160
	8721-249636-SW	5318	7020	178
 <p>Sidebar Table, 24" Wide 42" Height</p> <p>24 W x 60 L x 42 H 24 W x 72 L x 42 H 24 W x 84 L x 42 H 24 W x 96 L x 42 H</p>	8721-246042-SW	4455	5880	135
	8721-247242-SW	4778	6307	149
	8721-248442-SW	5158	6809	165
	8721-249642-SW	5593	7383	183
 <p>Sidebar Table, 30" Wide 29" Height</p> <p>30 W x 60 L x 29 H 30 W x 72 L x 29 H 30 W x 84 L x 29 H 30 W x 96 L x 29 H</p>	8721-306029-SW	3869	5339	148
	8721-307229-SW	4203	5800	167
	8721-308429-SW	4570	6307	187
	8721-309629-SW	4925	6797	208
 <p>Sidebar Table, 30" Wide 36" Height</p> <p>30 W x 60 L x 36 H 30 W x 72 L x 36 H 30 W x 84 L x 36 H 30 W x 96 L x 36 H</p>	8721-306036-SW	4490	6197	153
	8721-307236-SW	4896	6756	172
	8721-308436-SW	5334	7362	192
	8721-309636-SW	5761	7950	213
 <p>Sidebar Table, 30" Wide 42" Height</p> <p>30 W x 60 L x 42 H 30 W x 72 L x 42 H 30 W x 84 L x 42 H 30 W x 96 L x 42 H</p>	8721-306042-SW	4765	6577	158
	8721-307242-SW	5171	7136	177
	8721-308442-SW	5610	7741	197
	8721-309642-SW	6036	8330	218

OPTIONS (XXXX - REFERS TO TABLE MODEL NUMBER)

MODEL	DESCRIPTION	LIST
XXXX-FR03	Foot Rest	292
XXXX-PF05	Premium Metal Accent Finish	160
XXXX-NS13A	Non-Skid Glides	20

DELEN MEETING TABLES

designed by ramsey madsen
and jim contoio

NOTES:

- Sidebar tables manufactured in Ash and Walnut.
- Veneer or laminate top available with self-edge or exposed plywood edge options.
- Solid Ash wood legs feature integrated metal accent detail, in all standard and premium metal finishes.
- 120" and 144" length tables feature two-piece tops and three bases.
- Optional metal footrest available and will match accent finish as standard.
- Refer to pages 21-23 for electrical unit options.

SPECIFY:



1. Model number
2. Wood species
3. Edge detail
4. Wood finish
5. Metal accent finish
6. Options, as applicable

ORDERING EXAMPLE:

#8722-248436-SE-PF05

24 x 84 x 36 Sidebar
Ash Veneer
Self Edge
Premium Metal Finish

SIN #711-11

VENEER/LAMINATE TOP - PLANK-STYLE	MODEL NUMBER	ASH VENEER OR LAMINATE WITH SELF EDGE (-SE)	ASH VENEER OR LAMINATE WITH EXPOSED EDGE (-EP)	WALNUT VENEER WITH SELF EDGE (-SE)	WALNUT VENEER WITH EXPOSED EDGE (-EP)	WEIGHT
 <p>Sidebar Table, 24" Wide 29" Height</p> <p>24 W x 60 L x 29 H 24 W x 72 L x 29 H 24 W x 84 L x 29 H 24 W x 96 L x 29 H 24 W x 120 L x 29 H 24 W x 144 L x 29 H</p>	8722-246029-(-)	3266	3266	3659	3659	109
	8722-247229-(-)	3451	3451	3866	3866	122
	8722-248429-(-)	3581	3581	4011	4011	136
	8722-249629-(-)	3711	3711	4157	4157	152
	8722-2412029-(-)	5619	5619	6294	6294	209
	8722-2414429-(-)	5875	5875	6581	6581	243
 <p>Sidebar Table, 24" Wide 36" Height</p> <p>24 W x 60 L x 36 H 24 W x 72 L x 36 H 24 W x 84 L x 36 H 24 W x 96 L x 36 H 24 W x 120 L x 36 H 24 W x 144 L x 36 H</p>	8722-246036-(-)	3888	3888	4355	4355	114
	8722-247236-(-)	4144	4144	4641	4641	127
	8722-248436-(-)	4345	4345	4867	4867	141
	8722-249636-(-)	4547	4547	5093	5093	157
	8722-2412036-(-)	6818	6818	7637	7637	215
	8722-2414436-(-)	7217	7217	8083	8083	249
 <p>Sidebar Table, 24" Wide 42" Height</p> <p>24 W x 60 L x 42 H 24 W x 72 L x 42 H 24 W x 84 L x 42 H 24 W x 96 L x 42 H 24 W x 120 L x 42 H 24 W x 144 L x 42 H</p>	8722-246042-(-)	4163	4163	4662	4662	119
	8722-247242-(-)	4419	4419	4949	4949	132
	8722-248442-(-)	4620	4620	5175	5175	146
	8722-249642-(-)	4822	4822	5402	5402	162
	8722-2412042-(-)	7231	7231	8099	8099	221
	8722-2414442-(-)	7630	7630	8545	8545	255

OPTIONS (XXXX - REFERS TO TABLE MODEL NUMBER)

MODEL	DESCRIPTION	LIST
XXXX-FR03	Foot Rest, 1-piece top	292
XXXX-FR04	Foot Rest, 2-piece top	584
XXXX-PF05	Premium Metal Accent Finish, 1-piece top	160
XXXX-PF06	Premium Metal Accent Finish, 2-piece top	220
XXXX-NS13A	Non-Skid Glides, 1-piece top	20
XXXX-NS13B	Non-Skid Glides, 2-piece top	30

NOTES:

- Sidebar tables manufactured in Ash and Walnut.
- Veneer or laminate top available with self-edge or exposed plywood edge options.
- Solid Ash wood legs feature integrated metal accent detail, in all standard and premium metal finishes.
- 120" and 144" length tables feature two-piece tops and three bases.
- Optional metal footrest available and will match accent finish as standard.
- Refer to pages 21-23 for electrical unit options.

SPECIFY:

1. Model number
2. Wood species
3. Edge detail
4. Wood finish
5. Metal accent finish
6. Options, as applicable

ORDERING EXAMPLE:

#8722-3012042-SE-PF06



30 x 120 x 42 Sidebar
Ash Veneer
Self Edge
Premium Metal Finish

DELEN

MEETING TABLES

designed by ramsey madsen
and jim contoia

SIN #711-11

VENEER/LAMINATE TOP - PLANK-STYLE	MODEL NUMBER	ASH VENEER OR LAMINATE WITH SELF EDGE (-SE)	ASH VENEER OR LAMINATE WITH EXPOSED EDGE (-EP)	WALNUT VENEER WITH SELF EDGE (-SE)	WALNUT VENEER WITH EXPOSED EDGE (-EP)	WEIGHT
 <p>Sidebar Table, 30" Wide 29" Height</p> <p>30 W x 60 L x 29 H 30 W x 72 L x 29 H 30 W x 84 L x 29 H 30 W x 96 L x 29 H 30 W x 120 L x 29 H 30 W x 144 L x 29 H</p>	8722-306029-(-)	3987	3987	4466	4466	126
	8722-307229-(-)	4271	4271	4784	4784	143
	8722-308429-(-)	4427	4427	4959	4959	158
	8722-309629-(-)	4583	4583	5133	5133	174
	8722-3012029-(-)	7222	7222	8090	8090	230
	8722-3014429-(-)	7534	7534	8438	8438	263
 <p>Sidebar Table, 30" Wide 36" Height</p> <p>30 W x 60 L x 36 H 30 W x 72 L x 36 H 30 W x 84 L x 36 H 30 W x 96 L x 36 H 30 W x 120 L x 36 H 30 W x 144 L x 36 H</p>	8722-306036-(-)	4609	4609	5162	5162	131
	8722-307236-(-)	4964	4964	5560	5560	148
	8722-308436-(-)	5192	5192	5815	5815	163
	8722-309636-(-)	5418	5418	6069	6069	179
	8722-3012036-(-)	8421	8421	9433	9433	237
	8722-3014436-(-)	8876	8876	9942	9942	270
 <p>Sidebar Table, 30" Wide 42" Height</p> <p>30 W x 60 L x 42 H 30 W x 72 L x 42 H 30 W x 84 L x 42 H 30 W x 96 L x 42 H 30 W x 120 L x 42 H 30 W x 144 L x 42 H</p>	8722-306042-(-)	4884	4884	5471	5471	136
	8722-307242-(-)	5239	5239	5868	5868	153
	8722-308442-(-)	5467	5467	6123	6123	168
	8722-309642-(-)	5694	5694	6377	6377	184
	8722-3012042-(-)	8834	8834	9895	9895	244
	8722-3014442-(-)	9289	9289	10404	10404	277

OPTIONS (XXXX - REFERS TO TABLE MODEL NUMBER)

MODEL	DESCRIPTION	LIST
XXXX-FR03	Foot Rest, 1-piece top	292
XXXX-FR04	Foot Rest, 2-piece top	584
XXXX-PF05	Premium Metal Accent Finish, 1-piece top	160
XXXX-PF06	Premium Metal Accent Finish, 2-piece top	220
XXXX-NS13A	Non-Skid Glides, 1-piece top	20
XXXX-NS13B	Non-Skid Glides, 2-piece top	30

DELEN MEETING TABLES

designed by ramsey madsen
and jim contoio

NOTES:

- Sidebar tables manufactured in Ash and Walnut.
- Veneer or laminate top available with self-edge or exposed plywood edge options.
- Solid Ash wood legs feature integrated metal accent detail, in all standard and premium metal finishes.
- 120" and 144" length tables feature two-piece tops and three bases.
- Optional metal footrest available and will match accent finish as standard.
- Refer to pages 21-23 for electrical unit options.

SPECIFY:



1. Model number
2. Wood species
3. Edge detail
4. Wood finish
5. Metal accent finish
6. Options, as applicable

ORDERING EXAMPLE:

#8723-249629-EP-FR03

24 x 96 x 29 Sidebar
Walnut Veneer
Exposed Edge
Foot Rest

SIN #711-11

VENEER/LAMINATE TOP	MODEL NUMBER	ASH VENEER OR LAMINATE WITH SELF EDGE (-SE)	ASH VENEER OR LAMINATE WITH EXPOSED EDGE (-EP)	WALNUT VENEER WITH SELF EDGE (-SE)	WALNUT VENEER WITH EXPOSED EDGE (-EP)	WEIGHT
 <p>Sidebar Table, 24" Wide 29" Height</p> <p>24 W x 60 L x 29 H 24 W x 72 L x 29 H 24 W x 84 L x 29 H 24 W x 96 L x 29 H 24 W x 120 L x 29 H 24 W x 144 L x 29 H</p>	8723-246029-(-)	3202	3202	3555	3555	112
	8723-247229-(-)	3386	3386	3758	3758	125
	8723-248429-(-)	3513	3513	3899	3899	139
	8723-249629-(-)	3640	3640	4041	4041	155
	8723-2412029-(-)	5543	5543	6153	6153	213
	8723-2414429-(-)	5794	5794	6432	6432	247
 <p>Sidebar Table, 24" Wide 36" Height</p> <p>24 W x 60 L x 36 H 24 W x 72 L x 36 H 24 W x 84 L x 36 H 24 W x 96 L x 36 H 24 W x 120 L x 36 H 24 W x 144 L x 36 H</p>	8723-246036-(-)	3824	3824	4245	4245	117
	8723-247236-(-)	4079	4079	4528	4528	130
	8723-248436-(-)	4277	4277	4749	4749	144
	8723-249636-(-)	4476	4476	4968	4968	160
	8723-2412036-(-)	6743	6743	7485	7485	219
	8723-2414436-(-)	7136	7136	7922	7922	253
 <p>Sidebar Table, 24" Wide 42" Height</p> <p>24 W x 60 L x 42 H 24 W x 72 L x 42 H 24 W x 84 L x 42 H 24 W x 96 L x 42 H 24 W x 120 L x 42 H 24 W x 144 L x 42 H</p>	8723-246042-(-)	4099	4099	4550	4550	123
	8723-247242-(-)	4354	4354	4834	4834	135
	8723-248442-(-)	4552	4552	5053	5053	149
	8723-249642-(-)	4751	4751	5274	5274	165
	8723-2412042-(-)	7155	7155	7943	7943	225
	8723-2414442-(-)	7549	7549	8379	8379	259

OPTIONS (XXXX - REFERS TO TABLE MODEL NUMBER)

MODEL	DESCRIPTION	LIST
XXXX-FR03	Foot Rest, 1-piece top	292
XXXX-FR04	Foot Rest, 2-piece top	584
XXXX-PF05	Premium Metal Accent Finish, 1-piece top	160
XXXX-PF06	Premium Metal Accent Finish, 2-piece top	220
XXXX-NS13A	Non-Skid Glides, 1-piece top	20
XXXX-NS13B	Non-Skid Glides, 2-piece top	30

NOTES:

- Sidebar tables manufactured in Ash and Walnut.
- Veneer or laminate top available with self-edge or exposed plywood edge options.
- Solid Ash wood legs feature integrated metal accent detail, in all standard and premium metal finishes.
- 120" and 144" length tables feature two-piece tops and three bases.
- Optional metal footrest available and will match accent finish as standard.
- Refer to pages 21-23 for electrical unit options.

SPECIFY:

1. Model number
2. Wood species
3. Wood finish
4. Metal accent finish
5. Options, as applicable

ORDERING EXAMPLE:

#8723-3012042-SE-PF06



30 x 120 x 42 Sidebar
Ash Veneer
Self Edge
Premium Metal Finish

DELEN

MEETING TABLES

designed by ramsey madsen
and jim contoia

SIN #711-11

VENEER/LAMINATE TOP	MODEL NUMBER	ASH VENEER OR LAMINATE WITH SELF EDGE (-SE)	ASH VENEER OR LAMINATE WITH EXPOSED EDGE (-EP)	WALNUT VENEER WITH SELF EDGE (-SE)	WALNUT VENEER WITH EXPOSED EDGE (-EP)	WEIGHT	
 <p>Sidebar Table, 30" Wide 29" Height</p>	30 W x 60 L x 29 H	8723-306029-(-)	3923	3923	4355	4355	129
	30 W x 72 L x 29 H	8723-307229-(-)	4205	4205	4668	4668	146
	30 W x 84 L x 29 H	8723-308429-(-)	4358	4358	4838	4838	161
	30 W x 96 L x 29 H	8723-309629-(-)	4512	4512	5009	5009	177
	30 W x 120 L x 29 H	8723-3012029-(-)	7147	7147	7933	7933	233
	30 W x 144 L x 29 H	8723-3014429-(-)	7453	7453	8273	8273	266
 <p>Sidebar Table, 30" Wide 36" Height</p>	30 W x 60 L x 36 H	8723-306036-(-)	4545	4545	5046	5046	134
	30 W x 72 L x 36 H	8723-307236-(-)	4898	4898	5437	5437	151
	30 W x 84 L x 36 H	8723-308436-(-)	5122	5122	5686	5686	166
	30 W x 96 L x 36 H	8723-309636-(-)	5348	5348	5937	5937	182
	30 W x 120 L x 36 H	8723-3012036-(-)	8346	8346	9265	9265	240
	30 W x 144 L x 36 H	8723-3014436-(-)	8795	8795	9763	9763	273
 <p>Sidebar Table, 30" Wide 42" Height</p>	30 W x 60 L x 42 H	8723-306042-(-)	4820	4820	5350	5350	139
	30 W x 72 L x 42 H	8723-307242-(-)	5173	5173	5742	5742	156
	30 W x 84 L x 42 H	8723-308442-(-)	5397	5397	5992	5992	171
	30 W x 96 L x 42 H	8723-309642-(-)	5623	5623	6243	6243	187
	30 W x 120 L x 42 H	8723-3012042-(-)	8759	8759	9722	9722	247
	30 W x 144 L x 42 H	8723-3014442-(-)	9208	9208	10221	10221	280

OPTIONS (XXXX - REFERS TO TABLE MODEL NUMBER)

MODEL	DESCRIPTION	LIST
XXXX-FR03	Foot Rest, 1-piece top	292
XXXX-FR04	Foot Rest, 2-piece top	584
XXXX-PF05	Premium Metal Accent Finish, 1-piece top	160
XXXX-PF06	Premium Metal Accent Finish, 2-piece top	220
XXXX-NS13A	Non-Skid Glides, 1-piece top	20
XXXX-NS13B	Non-Skid Glides, 2-piece top	30

DELEN MEETING TABLES

designed by ramsey madsen
and jim contoio

NOTES:

- Tables manufactured in Ash and Walnut.
- Solid wood top standard with matching edge.
- Solid Ash wood legs feature integrated metal accent detail, in all standard and premium metal finishes.
- Refer to pages 21-23 for electrical unit options.

SPECIFY:



1. Model number
2. Wood species
3. Wood finish
4. Metal accent finish
5. Options, as applicable

ORDERING EXAMPLE:

#8731-428429-SW-PF05

42 x 48 x 29 Rectangle
Walnut Solid Wood
Premium Metal Finish

SIN #711-11

SOLID WOOD TOP - PLANK-STYLE	MODEL NUMBER	SOLID ASH WOOD	SOLID WALNUT WOOD	WEIGHT	
 <p>Rectangle Table, 29" Height</p> <p>36 W x 60 L x 29 H 36 W x 72 L x 29 H 36 W x 84 L x 29 H 36 W x 96 L x 29 H</p> <p>42 W x 60 L x 29 H 42 W x 72 L x 29 H 42 W x 84 L x 29 H 42 W x 96 L x 29 H</p> <p>48 W x 84 L x 29 H 48 W x 96 L x 29 H</p> <p>54 W x 84 L x 29 H 54 W x 96 L x 29 H</p>	8731-366029-SW	4856	6702	171	
	8731-367229-SW	5279	7285	195	
	8731-368429-SW	5791	7992	210	
	8731-369629-SW	6930	9564	241	
	8731-426029-SW	5166	7440	191	
	8731-427229-SW	5729	8250	218	
	8731-428429-SW	6274	9035	246	
	8731-429629-SW	7483	10776	273	
	8731-488429-SW	6894	9927	273	
	8731-489629-SW	8282	11926	305	
	8731-548429-SW	7523	10833	301	
	8731-549629-SW	8914	12837	336	
	 <p>Rectangle Table, 36" Height</p> <p>36 W x 60 L x 36 H 36 W x 72 L x 36 H 36 W x 84 L x 36 H 36 W x 96 L x 36 H</p> <p>42 W x 60 L x 36 H 42 W x 72 L x 36 H 42 W x 84 L x 36 H 42 W x 96 L x 36 H</p> <p>48 W x 84 L x 36 H 48 W x 96 L x 36 H</p> <p>54 W x 84 L x 36 H 54 W x 96 L x 36 H</p>	8731-366036-SW	5192	7165	175
		8731-367236-SW	5615	7748	200
		8731-368436-SW	6127	8456	215
		8731-369636-SW	7266	10028	246
8731-426036-SW		5502	7924	196	
8731-427236-SW		6065	8734	223	
8731-428436-SW		6610	9519	251	
8731-429636-SW		7819	11260	278	
8731-488436-SW		7230	10411	278	
8731-489636-SW		8618	12410	310	
8731-548436-SW		7859	11316	306	
8731-549636-SW		9250	13320	340	

OPTIONS (XXXX - REFERS TO TABLE MODEL NUMBER)

MODEL	DESCRIPTION	LIST
XXXX-PF05	Premium Metal Accent Finish	160
XXXX-NS13A	Non-Skid Glides	20

NOTES:

- Tables manufactured in Ash and Walnut.
- Solid wood top standard with matching edge.
- Solid Ash wood legs feature integrated metal accent detail, in all standard and premium metal finishes.
- Refer to pages 21-23 for electrical unit options.

SPECIFY:

1. Model number
2. Wood species
3. Wood finish
4. Metal accent finish
5. Options, as applicable

ORDERING EXAMPLE:

#8731-366042-SW-PF05

36 x 60 x 42 Rectangle
Walnut Solid Wood
Premium Metal Finish

DELEN

MEETING TABLES

designed by ramsey madsen
and jim contoio

SIN #711-11

SOLID WOOD TOP - PLANK-STYLE	MODEL NUMBER	SOLID ASH WOOD	SOLID WALNUT WOOD	WEIGHT
 <p>Rectangle Table, 42" Height</p> <p>36 W x 60 L x 42 H 36 W x 72 L x 42 H 36 W x 84 L x 42 H 36 W x 96 L x 42 H</p> <p>42 W x 60 L x 42 H 42 W x 72 L x 42 H 42 W x 84 L x 42 H 42 W x 96 L x 42 H</p>	8731-366042-SW	5862	8090	180
	8731-367242-SW	6356	8772	205
	8731-368442-SW	6940	9578	220
	8731-369642-SW	7596	10483	251
	8731-426042-SW	6172	8889	201
	8731-427242-SW	6807	9802	228
	8731-428442-SW	7423	10689	256
	8731-429642-SW	8148	11734	283

OPTIONS (XXXX - REFERS TO TABLE MODEL NUMBER)

MODEL	DESCRIPTION	LIST
XXXX-PF05	Premium Metal Accent Finish	160
XXXX-NS13A	Non-Skid Glides	20

DELEN MEETING TABLES

designed by ramsey madsen
and jim contoio

NOTES:

- Tables manufactured in Ash and Walnut.
- Veneer or laminate plank-style top available with self edge or exposed plywood edge options.
- Solid Ash wood legs feature integrated metal accent detail, in all standard and premium metal finishes.
- 120" length tables and longer require two-piece tops and three bases.
- Refer to pages 21-23 for electrical unit options.

SPECIFY:

1. Model number
2. Wood species
3. Wood finish
4. Edge detail
5. Metal accent finish
6. Options, as applicable

ORDERING EXAMPLE:

#8732-488429-EP-PF05

48 x 84 x 29 Rectangle
Exposed Edge
Premium Metal Finish

SIN #711-11

VENEER/LAMINATE TOP - PLANK STYLE	MODEL NUMBER	ASH VENEER OR LAMINATE WITH SELF EDGE (-SE)	ASH VENEER OR LAMINATE WITH EXPOSED EDGE (-EP)	WALNUT VENEER WITH SELF EDGE (-SE)	WALNUT VENEER WITH EXPOSED EDGE (-EP)	WEIGHT	
 <p>Rectangle Table 29" Height</p> <p>36 W x 60 L x 29 H 36 W x 72 L x 29 H Q S 36 W x 84 L x 29 H 36 W x 96 L x 29 H 36 W x 120 L x 29 H 36 W x 144 L x 29 H 36 W x 192 L x 29 H</p>	8732-366029-()	4472	4472	5010	5010	139	
	8732-367229-()	4654	4654	5213	5213	158	
	8732-368429-()	4834	4834	5414	5414	170	
	8732-369629-()	5568	5568	6236	6236	196	
	8732-3612029-()	7611	7611	8524	8524	260	
	8732-3614429-()	8113	8113	9087	9087	297	
	8732-3619229-()	8589	8589	9621	9621	374	
	42 W x 60 L x 29 H	8732-426029-()	4634	4634	5191	5191	155
	42 W x 72 L x 29 H	8732-427229-()	4846	4846	5428	5428	177
	42 W x 84 L x 29 H	8732-428429-()	5059	5059	5667	5667	200
42 W x 96 L x 29 H	8732-429629-()	5827	5827	6526	6526	222	
42 W x 120 L x 29 H	8732-4212029-()	7961	7961	8916	8916	282	
42 W x 144 L x 29 H	8732-4214429-()	8526	8526	9550	9550	331	
42 W x 192 L x 29 H	8732-4219229-()	9680	9680	10843	10843	421	
48 W x 84 L x 29 H	8732-488429-()	5397	5397	6045	6045	222	
48 W x 96 L x 29 H	8732-489629-()	6190	6190	6934	6934	248	
48 W x 120 L x 29 H	8732-4812029-()	8385	8385	9392	9392	321	
48 W x 144 L x 29 H	8732-4814429-()	9005	9005	10087	10087	370	
48 W x 192 L x 29 H	8732-4819229-()	10266	10266	11499	11499	455	
54 W x 84 L x 29 H	8732-548429-()	5925	5925	6636	6636	245	
54 W x 96 L x 29 H	8732-549629-()	6744	6744	7553	7553	273	
54 W x 120 L x 29 H	8732-5412029-()	9328	9328	10447	10447	360	
54 W x 144 L x 29 H	8732-5414429-()	10000	10000	11200	11200	409	
54 W x 192 L x 29 H	8732-5419229-()	11160	11160	12500	12500	495	

OPTIONS (XXXX - REFERS TO TABLE MODEL NUMBER)

MODEL	DESCRIPTION	LIST
XXXX-PF05	Premium Metal Accent Finish, 1-piece top	160
XXXX-PF06	Premium Metal Accent Finish, 2-piece top	220
XXXX-NS13A	Non-Skid Glides, 1-piece top	20
XXXX-NS13B	Non-Skid Glides, 2-piece top	30

Q S = Available on Quick-Ship Program, model #8732-367229-EP (exposed edge, standard metal finishes only).

NOTES:

- Tables manufactured in Ash and Walnut.
- Veneer or laminate plank-style top available with self-edge or exposed plywood edge options.
- Solid Ash wood legs feature integrated metal accent detail, in all standard and premium metal finishes.
- 120" length tables and longer require two-piece tops and three bases.
- Refer to pages 21-23 for electrical unit options.

SPECIFY:

1. Model number
2. Wood species
3. Wood finish
4. Edge detail
5. Metal accent finish
6. Options, as applicable

ORDERING EXAMPLE:

#8732-428436-EP-PF05

42 x 84 x 36 Rectangle
Walnut Veneer
Exposed Edge
Premium Metal Finish

DELEN MEETING TABLES

designed by ramsey madsen
and jim contoio

SIN #711-11

VENEER/LAMINATE TOP - PLANK STYLE	MODEL NUMBER	ASH VENEER OR LAMINATE WITH SELF EDGE (-SE)	ASH VENEER OR LAMINATE WITH EXPOSED EDGE (-EP)	WALNUT VENEER WITH SELF EDGE (-SE)	WALNUT VENEER WITH EXPOSED EDGE (-EP)	WEIGHT	
 <p>Rectangle Table 36" Height</p>	36 W x 60 L x 36 H	8732-366036-()	4808	4808	5386	5386	144
	36 W x 72 L x 36 H	8732-367236-()	4990	4990	5590	5590	163
	36 W x 84 L x 36 H	8732-368436-()	5170	5170	5790	5790	175
	36 W x 96 L x 36 H	8732-369636-()	5904	5904	6612	6612	201
	36 W x 120 L x 36 H	8732-3612036-()	7947	7947	8901	8901	267
	36 W x 144 L x 36 H	8732-3614436-()	8449	8449	9463	9463	304
	36 W x 192 L x 36 H	8732-3619236-()	8925	8925	9996	9996	381
	42 W x 60 L x 36 H	8732-426036-()	4970	4970	5567	5567	160
	42 W x 72 L x 36 H	8732-427236-()	5182	5182	5805	5805	182
	42 W x 84 L x 36 H	8732-428436-()	5395	5395	6043	6043	205
	42 W x 96 L x 36 H	8732-429636-()	6163	6163	6903	6903	227
	42 W x 120 L x 36 H	8732-4212036-()	8297	8297	9293	9293	289
	42 W x 144 L x 36 H	8732-4214436-()	8862	8862	9926	9926	338
	42 W x 192 L x 36 H	8732-4219236-()	10016	10016	11219	11219	428
	48 W x 84 L x 36 H	8732-488436-()	5733	5733	6422	6422	227
	48 W x 96 L x 36 H	8732-489636-()	6526	6526	7310	7310	253
	48 W x 120 L x 36 H	8732-4812036-()	8721	8721	9768	9768	328
	48 W x 144 L x 36 H	8732-4814436-()	9341	9341	10463	10463	378
	48 W x 192 L x 36 H	8732-4819236-()	10602	10602	11875	11875	462
	54 W x 84 L x 36 H	8732-548436-()	6261	6261	7012	7012	250
	54 W x 96 L x 36 H	8732-549636-()	7080	7080	7930	7930	278
54 W x 120 L x 36 H	8732-5412036-()	9664	9664	10824	10824	368	
54 W x 144 L x 36 H	8732-5414436-()	10336	10336	11577	11577	416	
54 W x 192 L x 36 H	8732-5419236-()	11496	11496	12876	12876	502	

OPTIONS (XXXX - REFERS TO TABLE MODEL NUMBER)

MODEL	DESCRIPTION	LIST
XXXX-PF05	Premium Metal Accent Finish, 1-piece top	160
XXXX-PF06	Premium Metal Accent Finish, 2-piece top	220
XXXX-NS13A	Non-Skid Glides, 1-piece top	20
XXXX-NS13B	Non-Skid Glides, 2-piece top	30

DELEN MEETING TABLES

designed by ramsey madsen
and jim contoio

NOTES:

- Tables manufactured in Ash and Walnut.
- Veneer or laminate plank-style top available with self-edge or exposed plywood edge options.
- Solid Ash wood legs feature integrated metal accent detail, in all standard and premium metal finishes.
- 120" length tables and longer require two-piece tops and three bases.
- Refer to pages 21-23 for electrical unit options.

SPECIFY:

1. Model number
2. Wood species
3. Wood finish
4. Edge detail
5. Metal accent finish
6. Options, as applicable

ORDERING EXAMPLE:

#8732-367242-EP-PF05

36 x 72 x 42 Rectangle
Walnut Veneer
Exposed Edge
Premium Metal Finish

SIN #711-11

VENEER/LAMINATE TOP - PLANK STYLE	MODEL NUMBER	ASH VENEER OR LAMINATE WITH SELF EDGE (-SE)	ASH VENEER OR LAMINATE WITH EXPOSED EDGE (-EP)	WALNUT VENEER WITH SELF EDGE (-SE)	WALNUT VENEER WITH EXPOSED EDGE (-EP)	WEIGHT
 <p>Rectangle Table 42" Height</p> <p>36 W x 60 L x 42 H 36 W x 72 L x 42 H Q S 36 W x 84 L x 42 H 36 W x 96 L x 42 H 36 W x 120 L x 42 H 36 W x 144 L x 42 H 36 W x 192 L x 42 H</p> <p>42 W x 60 L x 42 H 42 W x 72 L x 42 H 42 W x 84 L x 42 H 42 W x 96 L x 42 H 42 W x 120 L x 42 H 42 W x 144 L x 42 H 42 W x 192 L x 42 H</p>	8732-366042-()	5478	5478	6137	6137	149
	Q S 8732-367242-()	5731	5731	6419	6419	168
	8732-368442-()	5982	5982	6701	6701	180
	8732-369642-()	6233	6233	6982	6982	206
	8732-3612042-()	8277	8277	9270	9270	274
	8732-3614442-()	8778	8778	9833	9833	311
	8732-3619242-()	9255	9255	10366	10366	388
	8732-426042-()	4974	4974	6317	6317	165
	8732-427242-()	5924	5924	6634	6634	187
	8732-428442-()	6208	6208	6954	6954	210
	8732-429642-()	6493	6493	7272	7272	232
	8732-4212042-()	8626	8626	9662	9662	296
	8732-4214442-()	9192	9192	10296	10296	345
	8732-4219242-()	10346	10346	11588	11588	435

OPTIONS (XXXX - REFERS TO TABLE MODEL NUMBER)

MODEL	DESCRIPTION	LIST
XXXX-PF05	Premium Metal Accent Finish, 1-piece top	160
XXXX-PF06	Premium Metal Accent Finish, 2-piece top	220
XXXX-NS13A	Non-Skid Glides, 1-piece top	20
XXXX-NS13B	Non-Skid Glides, 2-piece top	30

Q S = Available on Quick-Ship Program, model #8732-367242-EP (exposed edge, standard metal finishes only).

NOTES:

- Tables manufactured in Ash and Walnut.
- Veneer or laminate top available with self-edge or exposed plywood edge options.
- Solid Ash wood legs feature integrated metal accent detail, in all standard and premium metal finishes.
- 120" length tables and longer require two-piece tops and three bases.
- Refer to pages 21-23 for electrical unit options.

SPECIFY:

1. Model number
2. Wood species
3. Wood finish
4. Edge detail
5. Metal accent finish
6. Options, as applicable

ORDERING EXAMPLE:

#8733-3612029-SE-PF06

36 x 120 x 29 Rectangle
Ash Veneer
Self Edge
Premium Metal Finish

DELEN

MEETING TABLES

designed by ramsey madsen
and jim contoio

SIN #711-11

VENEER/LAMINATE TOP	MODEL NUMBER	ASH VENEER OR LAMINATE WITH SELF EDGE (-SE)	ASH VENEER OR LAMINATE WITH EXPOSED EDGE (-EP)	WALNUT VENEER WITH SELF EDGE (-SE)	WALNUT VENEER WITH EXPOSED EDGE (-EP)	WEIGHT
 <p>Rectangle Table 29" Height</p> <p>36 W x 60 L x 29 H 36 W x 72 L x 29 H Q S 36 W x 84 L x 29 H 36 W x 96 L x 29 H 36 W x 120 L x 29 H 36 W x 144 L x 29 H 36 W x 192 L x 29 H</p>	8733-366029-(-)	4357	4357	4880	4880	142
	8733-367229-(-)	4539	4539	5084	5084	161
	8733-368429-(-)	4718	4718	5285	5285	173
	8733-369629-(-)	5452	5452	6107	6107	199
	8733-3612029-(-)	7495	N/A	8395	N/A	264
	8733-3614429-(-)	7997	N/A	8957	N/A	301
	8733-3619229-(-)	9028	N/A	10112	N/A	378
	8733-426029-(-)	4506	4506	5047	5047	158
	8733-427229-(-)	4715	4715	5281	5281	180
	8733-428429-(-)	4923	4923	5514	5514	203
8733-429629-(-)	5685	5685	6368	6368	225	
8733-4212029-(-)	7809	N/A	8747	N/A	286	
8733-4214429-(-)	8366	N/A	9371	N/A	335	
8733-4219229-(-)	9501	N/A	10641	N/A	425	
8733-488429-(-)	5261	5261	5893	5893	225	
8733-489629-(-)	6050	6050	6776	6776	251	
8733-4812029-(-)	8235	N/A	9224	N/A	325	
8733-4814429-(-)	8846	N/A	9907	N/A	374	
8733-4819229-(-)	10088	N/A	11298	N/A	459	
8733-548429-(-)	5788	N/A	6483	N/A	248	
8733-549629-(-)	6603	N/A	7396	N/A	276	
8733-5412029-(-)	9176	N/A	10278	N/A	364	
8733-5414429-(-)	9840	N/A	11021	N/A	413	
8733-5419229-(-)	10980	N/A	12298	N/A	499	

OPTIONS (XXXX - REFERS TO TABLE MODEL NUMBER)

MODEL	DESCRIPTION	LIST
XXXX-PF05	Premium Metal Accent Finish, 1-piece top	160
XXXX-PF06	Premium Metal Accent Finish, 2-piece top	220
XXXX-NS13A	Non-Skid Glides, 1-piece top	20
XXXX-NS13B	Non-Skid Glides, 2-piece top	30

Q S = Available on Quick-Ship Program, model #8733-367229-EP (exposed edge, standard metal finishes only).

DELEN MEETING TABLES

designed by ramsey madsen
and jim contoio

NOTES:

- Tables manufactured in Ash and Walnut.
- Veneer or laminate top available with self-edge or exposed plywood edge options.
- Solid Ash wood legs feature integrated metal accent detail, in all standard and premium metal finishes.
- 120" length tables and longer require two-piece tops and three bases.
- Refer to pages 21-23 for electrical unit options.

SPECIFY:

1. Model number
2. Wood species
3. Wood finish
4. Edge detail
5. Metal accent finish
6. Options, as applicable

ORDERING EXAMPLE:

#8733-489636-EP-PF05

48 x 96 x 36 Rectangle
Ash Veneer
Exposed Edge
Premium Metal Finish

SIN #711-11

VENEER/LAMINATE TOP	MODEL NUMBER	ASH VENEER OR LAMINATE WITH SELF EDGE (-SE)	ASH VENEER OR LAMINATE WITH EXPOSED EDGE (-EP)	WALNUT VENEER WITH SELF EDGE (-SE)	WALNUT VENEER WITH EXPOSED EDGE (-EP)	WEIGHT	
 <p>Rectangle Table 36" Height</p>	36 W x 60 L x 36 H	8733-366036-()	4693	4693	5257	5257	147
	36 W x 72 L x 36 H	8733-367236-()	4875	4875	5460	5460	166
	36 W x 84 L x 36 H	8733-368436-()	5054	5054	5661	5661	178
	36 W x 96 L x 36 H	8733-369636-()	5788	5788	6483	6483	204
	36 W x 120 L x 36 H	8733-3612036-()	7831	N/A	8771	N/A	271
	36 W x 144 L x 36 H	8733-3614436-()	8333	N/A	9334	N/A	308
	36 W x 192 L x 36 H	8733-3619236-()	9364	N/A	10489	N/A	385
	42 W x 60 L x 36 H	8733-426036-()	4842	4842	5424	5424	163
	42 W x 72 L x 36 H	8733-427236-()	5051	5051	5658	5658	185
	42 W x 84 L x 36 H	8733-428436-()	5259	5259	5890	5890	208
	42 W x 96 L x 36 H	8733-429636-()	6021	6021	6745	6745	230
	42 W x 120 L x 36 H	8733-4212036-()	8145	N/A	9123	N/A	293
	42 W x 144 L x 36 H	8733-4214436-()	8702	N/A	9747	N/A	342
	42 W x 192 L x 36 H	8733-4219236-()	9837	N/A	11018	N/A	432
	48 W x 84 L x 36 H	8733-488436-()	5597	5597	6269	6269	230
	48 W x 96 L x 36 H	8733-489636-()	6386	6386	7152	7152	256
	48 W x 120 L x 36 H	8733-4812036-()	8571	N/A	9600	N/A	332
	48 W x 144 L x 36 H	8733-4814436-()	9182	N/A	10284	N/A	382
	48 W x 192 L x 36 H	8733-4819236-()	10424	N/A	11675	N/A	466
	54 W x 84 L x 36 H	8733-548436-()	6124	N/A	6859	N/A	253
54 W x 96 L x 36 H	8733-549636-()	6939	N/A	7772	N/A	281	
54 W x 120 L x 36 H	8733-5412036-()	9512	N/A	10655	N/A	372	
54 W x 144 L x 36 H	8733-5414436-()	10176	N/A	11397	N/A	420	
54 W x 192 L x 36 H	8733-5419236-()	11316	N/A	12675	N/A	506	

OPTIONS (XXXX - REFERS TO TABLE MODEL NUMBER)

MODEL	DESCRIPTION	LIST
XXXX-PF05	Premium Metal Accent Finish, 1-piece top	160
XXXX-PF06	Premium Metal Accent Finish, 2-piece top	220
XXXX-NS13A	Non-Skid Glides, 1-piece top	20
XXXX-NS13B	Non-Skid Glides, 2-piece top	30

NOTES:

- Tables manufactured in Ash and Walnut.
- Veneer or laminate top available with self-edge or exposed plywood edge options.
- Solid Ash wood legs feature integrated metal accent detail, in all standard and premium metal finishes.
- 120" length tables and longer require two-piece tops and three bases.
- Refer to pages 21-23 for electrical unit options.

SPECIFY:

1. Model number
2. Wood species
3. Wood finish
4. Edge detail
5. Metal accent finish
6. Options, as applicable

ORDERING EXAMPLE:

#8733-4214442-SE-PF06

42 x 144 x 42 Rectangle
Walnut Veneer
Self Edge
Premium Metal Finish

DELEN MEETING TABLES

designed by ramsey madsen
and jim conto

SIN #711-11

VENEER/LAMINATE TOP	MODEL NUMBER	ASH VENEER OR LAMINATE WITH SELF EDGE (-SE)	ASH VENEER OR LAMINATE WITH EXPOSED EDGE (-EP)	WALNUT VENEER WITH SELF EDGE (-SE)	WALNUT VENEER WITH EXPOSED EDGE (-EP)	WEIGHT
 <p>Rectangle Table 42" Height</p> <p>36 W x 60 L x 42 H 36 W x 72 L x 42 H Q S 36 W x 84 L x 42 H 36 W x 96 L x 42 H 36 W x 120 L x 42 H 36 W x 144 L x 42 H 36 W x 192 L x 42 H</p> <p>42 W x 60 L x 42 H 42 W x 72 L x 42 H 42 W x 84 L x 42 H 42 W x 96 L x 42 H 42 W x 120 L x 42 H 42 W x 144 L x 42 H 42 W x 192 L x 42 H</p>	8733-366042-()	5363	5363	6006	6006	152
	8733-367242-()	5616	5616	6290	6290	171
	8733-368442-()	5867	5867	6571	6571	183
	8733-369642-()	6118	6118	6853	6853	209
	8733-3612042-()	8161	N/A	9141	N/A	278
	8733-3614442-()	8663	N/A	9702	N/A	315
	8733-3619242-()	9694	N/A	10857	N/A	392
	8733-426042-()	5512	5512	6173	6173	168
	8733-427242-()	5792	5792	6487	6487	190
	8733-428442-()	6072	6072	6800	6800	213
	8733-429642-()	6351	6351	7113	7113	235
	8733-4212042-()	8475	N/A	9492	N/A	300
	8733-4214442-()	9032	N/A	10116	N/A	349
	8733-4219242-()	10167	N/A	11387	N/A	439

OPTIONS (XXXX - REFERS TO TABLE MODEL NUMBER)

MODEL	DESCRIPTION	LIST
XXXX-PF05	Premium Metal Accent Finish, 1-piece top	160
XXXX-PF06	Premium Metal Accent Finish, 2-piece top	220
XXXX-NS13A	Non-Skid Glides, 1-piece top	20
XXXX-NS13B	Non-Skid Glides, 2-piece top	30

Q S = Available on Quick-Ship Program, model #8733-367242-EP (exposed edge, standard metal finishes only).

DELEN MEETING TABLES

designed by ramsey madsen
and jim contoio

NOTES:

- Tables manufactured in Ash and Walnut.
- Veneer or laminate top available with self-edge or exposed plywood edge options.
- Solid Ash wood legs feature integrated metal accent detail, in all standard and premium metal finishes.
- Refer to pages 21-23 for electrical unit options.

SPECIFY:

1. Model number
2. Wood species
3. Wood finish
4. Edge detail
5. Metal accent finish
6. Options, as applicable

ORDERING EXAMPLE:

#8743-6029-SE-PF05

60" Round
Walnut Veneer
Self Edge
Premium Metal Finish

SIN #711-11

VENEER/LAMINATE TOP	MODEL NUMBER	ASH VENEER OR LAMINATE WITH SELF EDGE (-SE)	ASH VENEER OR LAMINATE WITH EXPOSED EDGE (-EP)	WALNUT VENEER WITH SELF EDGE (-SE)	WALNUT VENEER WITH EXPOSED EDGE (-EP)	WEIGHT
 <p>Round Table 29" Height</p> <p>54" Dia. x 29 H</p> <p>60" Dia. x 29 H</p>	8743-5429-()	4360	4360	4840	4840	102
	8743-6029-()	4418	4418	4904	4904	125

OPTIONS (XXXX - REFERS TO TABLE MODEL NUMBER)

MODEL	DESCRIPTION	LIST
XXXX-PF05	Premium Metal Accent Finish	160
XXXX-NS13C	Non-Skid Glides	15

NOTES:

- Benches manufactured in Ash and Walnut.
- Solid wood seat standard with matching edge.
- Solid Ash wood legs feature integrated metal accent detail, in all standard and premium metal finishes.

SPECIFY:

1. Model number
2. Wood species
3. Wood finish
4. Metal accent finish
5. Options, as applicable

ORDERING EXAMPLE:

#8751-60-SW-PF05

60" Bench
Ash Solid Wood
Premium Metal Finish

DELEN MEETING TABLES

designed by ramsey madsen
and jim contoio

SIN #711-11

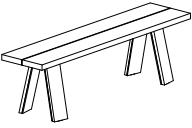
BENCH - SOLID WOOD SEAT WITH REVEAL		MODEL NUMBER	SOLID ASH WOOD	SOLID WALNUT WOOD	WEIGHT
 <p>Available Sizes</p> <p>14 W x 48 L x 17 H 14 W x 60 L x 17 H 14 W x 72 L x 17 H 14 W x 84 L x 17 H</p>		8751-48-SW	1701	2178	64
		8751-60-SW	2005	2548	70
		8751-72-SW	2284	2966	76
		8751-84-SW	2680	3456	84

OPTIONS (XXXX - REFERS TO BENCH MODEL NUMBER)

MODEL	DESCRIPTION	LIST
XXXX-PF05	Premium Metal Accent Finish	160
XXXX-NS13A	Non-Skid Glides	20

DELEN MEETING TABLES

designed by ramsey madsen
and jim contoio



SIN #711-11

NOTES:

- Benches manufactured in Ash and Walnut.
- Veneer or laminate finished seat available with self-edge or exposed plywood edge options.
- Solid Ash wood legs feature integrated metal accent detail, in all standard and premium metal finishes.

SPECIFY:

1. Model number
2. Wood species
3. Wood finish
4. Edge detail
5. Metal accent finish
6. Options, as applicable

ORDERING EXAMPLE:

#8752-72-EP-PF05

72" Bench
Walnut Veneer Seat
Exposed Edge
Premium Metal Finish

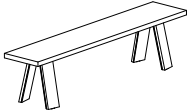
BENCH - VENEER/LAMINATE SEAT	MODEL NUMBER	ASH VENEER OR LAMINATE WITH SELF EDGE (-SE)	ASH VENEER OR LAMINATE WITH EXPOSED EDGE (-EP)	WALNUT VENEER WITH SELF EDGE (-SE)	WALNUT VENEER WITH EXPOSED EDGE (-EP)	WEIGHT
 <p>Available Sizes</p> <p>14 W x 48 L x 17 H 14 W x 60 L x 17 H 14 W x 72 L x 17 H 14 W x 84 L x 17 H</p>	8752-48(-)	1679	1679	1860	1860	57
	8752-60(-)	1871	1871	2026	2026	63
	8752-72(-)	2074	2074	2232	2232	69
	8752-84(-)	2260	2260	2412	2412	77

OPTIONS (XXXX - REFERS TO BENCH MODEL NUMBER)

MODEL	DESCRIPTION	LIST
XXXX-PF05	Premium Metal Accent Finish	160
XXXX-NS13A	Non-Skid Glides	20



NOTES:

- All units below are corded.
- Cord length should be taken into account when specifying electrical placement.
- Refer to page 24 for power unit standard locations. Please note that placement directly over bases is not available due to the limited opening size.
- Vertical wire manager is recommended and must be specified separately, refer to page 23 for ordering information.

DELEN MEETING TABLES

designed by ramsey madsen
and jim contoio

SIN #711-11

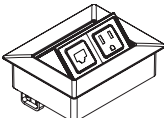
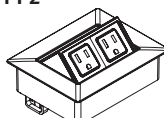
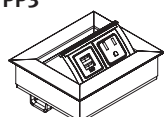
MODEL #	PRODUCT SPECIFICATIONS	LIST
<p>PB1-S (SILVER FINISH) PB1-W (WHITE FINISH)</p> 	<p>Power Band 1</p> <ul style="list-style-type: none"> ▪ Dimensions: 5³/₄" W x 2¹/₂" D ▪ Metallic Silver or White finish ▪ One (1) outlet and two (2) USB charging ports ▪ 108" electrical cord (only length available) ▪ UL Listed 	413
<p>PB2-S (SILVER FINISH) PB2-W (WHITE FINISH)</p> 	<p>Power Band 2</p> <ul style="list-style-type: none"> ▪ Dimensions: 5³/₄" W x 2¹/₂" D ▪ Metallic Silver or White finish ▪ Two (2) outlets ▪ 108" electrical cord (only length available) ▪ UL Listed 	322
<p>PB3-S (SILVER FINISH) PB3-W (WHITE FINISH)</p> 	<p>Power Band 3</p> <ul style="list-style-type: none"> ▪ Dimensions: 6¹/₂" W x 2¹/₂" D ▪ Metallic Silver or White finish ▪ Two (2) outlets and two (2) USB charging ports ▪ 108" electrical cord (only length available) ▪ UL Listed 	429
<p>PP1</p> 	<p>Portal Power 1</p> <ul style="list-style-type: none"> ▪ Dimensions: 5¹/₄" W x 4¹/₄" D ▪ Touch latch lid with Satin Nickel finish ▪ Unit features one simplex outlet with 72" electrical cord and one RJ-45 jack (Cat 6) with 72" patch cable ▪ 120" length cord available, please specify and add \$30 List ▪ UL listed 	612
<p>PP2</p> 	<p>Portal Power 2</p> <ul style="list-style-type: none"> ▪ Dimensions: 5¹/₄" W x 4¹/₄" D ▪ Touch latch lid with Satin Nickel finish ▪ Unit features two simplex outlets with 72" electrical cord ▪ 120" length cord available, please specify and add \$30 List ▪ UL listed 	542
<p>PP3</p> 	<p>Portal Power 3</p> <ul style="list-style-type: none"> ▪ Dimensions: 5¹/₄" W x 4¹/₄" D ▪ Touch latch lid with Satin Nickel finish ▪ Unit features one simplex outlet with 72" electrical cord and dual USB charging ports ▪ 120" length cord available, please specify and add \$30 List ▪ UL listed 	643

DELEN MEETING TABLES

designed by ramsey madsen
and jim contoio

NOTES:

- All units below are corded.
- Cord length should be taken into account when specifying electrical placement.
- Refer to page 24 for power unit standard locations. Please note that placement directly over bases is not available due to the limited opening size.
- Vertical wire manager is recommended and must be specified separately, refer to page 23 for ordering information.
- For the following technology units, please reference A/V jack combination options below. The price of individual A/V jacks must be added to the Base Model unit price listed below.
- Please contact Customer Service for faceplate/jack combinations that may not be referenced herein.
- Select units show open port positions which, once A/V jacks are purchased, can be reconfigured with different A/V jacks as needed.
- A/V jacks and faceplates snap into opening(s) in metal housing of Base Model units.

SIN #711-11

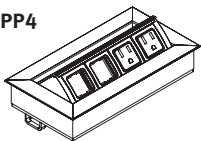
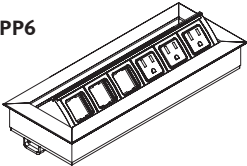
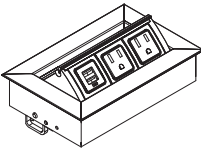
MODEL #	PRODUCT SPECIFICATIONS	LIST
<p>PP4</p> 	<p>Portal Power 4</p> <ul style="list-style-type: none"> ▪ Dimensions: 8⁵/₁₆" W x 4¹/₄" D ▪ Touch latch lid with clear anodized aluminum finish ▪ Two (2) 15 amp simplex outlets and two (2) open ports ▪ 72" electrical cord, no A/V jacks included ▪ 120" length cord available, please specify and add \$30 List ▪ UL Listed 	<p>575</p>
<p>PP6</p> 	<p>Portal Power 6</p> <ul style="list-style-type: none"> ▪ Dimensions: 9¹³/₁₆" W x 4¹/₄" D ▪ Touch latch lid with clear anodized aluminum finish ▪ Three (3) 15 amp simplex outlets and three (3) open ports ▪ 72" electrical cord, no A/V jacks included ▪ 120" length cord available, please specify and add \$30 List ▪ UL Listed 	<p>612</p>
<p>PP7</p> 	<p>Portal Power 7</p> <ul style="list-style-type: none"> ▪ Dimensions: 6³/₄" W x 4³/₈" D ▪ Touch latch lid with clear anodized aluminum finish ▪ Two (2) 15 amp simplex outlets and two (2) USB charging ports ▪ 72" electrical cord ▪ 120" length cord available, please specify and add \$30 List ▪ UL Listed 	<p>665</p>

FACEPLATE CONFIGURATION OPTIONS

ID#	PART #	A/V JACK DESCRIPTION(S)	LIST
1)	Q1	(1) RJ-45 (Cat 5e), punchdown	\$33
2)	Q2	(1) RJ-45 (Cat 6), male/female pre-terminated, 72" long	\$87
3)	Q3	(1) RJ-45 (Cat 6), male/female pre-terminated, 120" long	\$87
4)	Q4	15 pin HD VGA with male/female cable, 72" long	\$87
5)	Q5	15 pin HD VGA with male/female cable, 120" long	\$102
6)	Q6	3.5mm Mini-Stereo jack with male/female cable, 120" long	\$33
7)	Q9	HDMI Corded Coupler, 18" long	\$82

NOTES:

- All units below are corded.
- Cord length should be taken into account when specifying electrical placement.
- Refer to page 24 for power unit standard locations. Please note that placement directly over bases is not available due to the limited opening size.
- Vertical wire manager is recommended and must be specified separately, refer to page 23 for ordering information.
- For the following technology units, please reference A/V jack combination options below. The price of individual A/V jacks must be added to the Base Model unit price listed below.
- Please contact Customer Service for faceplate/jack combinations that may not be referenced herein.
- Select units show open port positions which, once A/V jacks are purchased, can be reconfigured with different A/V jacks as needed.
- A/V jacks and faceplates snap into opening(s) in metal housing of Base Model units.

DELEN MEETING TABLES

designed by ramsey madsen
and jim contoia

SIN #711-11

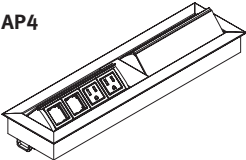
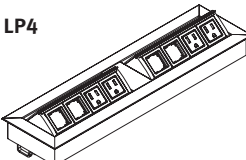
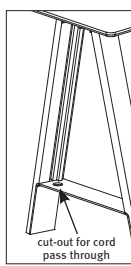
MODEL #	PRODUCT SPECIFICATIONS	LIST
<p>AP4</p> 	<p>Alternate Portal 4</p> <ul style="list-style-type: none"> ▪ Dimensions: 16¹/₂" W x 4¹/₂" D ▪ Touch latch lid with clear anodized aluminum finish ▪ Four (4) 15 amp simplex outlets and four (4) open ports ▪ 72" electrical cord, no A/V jacks included ▪ 120" length cord available, please specify and add \$30 List ▪ UL Listed 	1136
<p>LP4</p> 	<p>Linear Portal</p> <ul style="list-style-type: none"> ▪ Dimensions: 16¹/₂" W x 4¹/₂" D ▪ Touch latch lid with clear anodized aluminum finish ▪ Four (4) 15 amp simplex outlets and four (4) open ports ▪ 72" electrical cord, no A/V jacks included ▪ 120" length cord available, please specify and add \$30 List ▪ UL Listed 	1136
<p>WM01</p>  <p>cut-out for cord pass through</p>	<p>Vertical Wire Manager - leg location must be identified</p> <ul style="list-style-type: none"> ▪ 1/2" wide channel groove is added to leg interior for cord placement ▪ Anodized aluminum cover ▪ 1 1/2" diameter cut-out in metal accent 	175

FACEPLATE CONFIGURATION OPTIONS

ID#	PART #	A/V JACK DESCRIPTION(S)	LIST
1)	Q1	(1) RJ-45 (Cat 5e), punchdown	\$33
2)	Q2	(1) RJ-45 (Cat 6), male/female pre-terminated, 72" long	\$87
3)	Q3	(1) RJ-45 (Cat 6), male/female pre-terminated, 120" long	\$87
4)	Q4	15 pin HD VGA with male/female cable, 72" long	\$87
5)	Q5	15 pin HD VGA with male/female cable, 120" long	\$102
6)	Q6	3.5mm Mini-Stereo jack with male/female cable, 120" long	\$33
7)	Q9	HDMI Corded Coupler, 18" long	\$82

DELEN MEETING TABLES

designed by ramsey madsen
and jim contoio

NOTES:

- For custom power unit placement, please contact Customer Service to verify location can be accommodated.

SIN #711-11

POWER UNIT STANDARD LOCATIONS

Wall-Mount Tables - 1 Power Unit

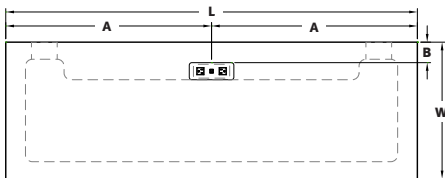

W X L	A	B
20" x 60"	30"	3"
20" x 72"	36"	3"
20" x 84"	42"	3"
20" x 96"	48"	3"

Wall-Mount Tables - 2 Power Units

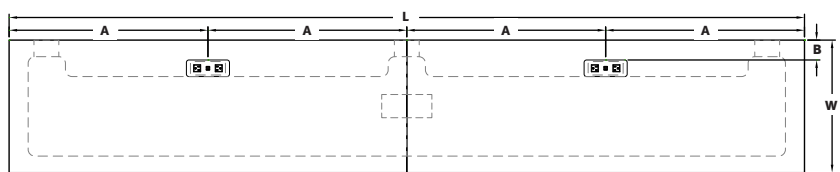
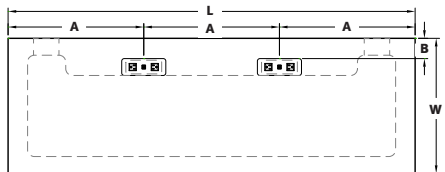

W X L	A	B
20" x 60"	20"	3"
20" x 72"	24"	3"
20" x 84"	28"	3"
20" x 96"	32"	3"
20" x 120"	40"	3"
20" x 144"	48"	3"

For tables 120" and over, single power unit cannot be centered on tops due to center base placement. Please specify location as applicable.

NOTES:

- For custom power unit placement, please contact Customer Service to verify location can be accommodated.

DELEN MEETING TABLES

designed by ramsey madsen
and jim contoio

SIN #711-11

Sidebar Tables - 1 Power Unit

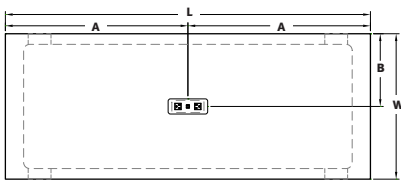

W X L	A	B
24" x 60"	30"	12"
24" x 72"	36"	12"
24" x 84"	42"	12"
24" x 96"	48"	12"
30" x 60"	30"	15"
30" x 72"	36"	15"
30" x 84"	42"	15"
30" x 96"	48"	15"

Sidebar Tables - 2 Power Units

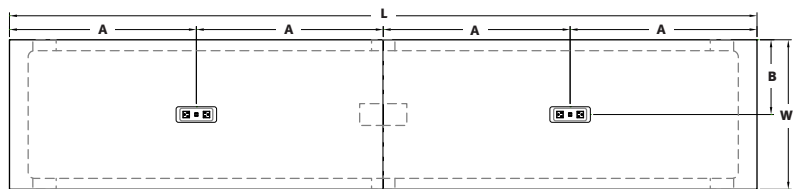
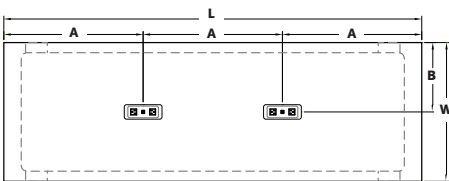

W X L	A	B
24" x 60"	20"	12"
24" x 72"	24"	12"
24" x 84"	28"	12"
24" x 96"	32"	12"
24" x 120"	40"	12"
24" x 144"	48"	12"
24" x 192"	64"	12"
30" x 60"	20"	15"
30" x 72"	24"	15"
30" x 84"	28"	15"
30" x 96"	32"	15"
30" x 120"	40"	15"
30" x 144"	48"	15"

For tables 120" and over, single power unit cannot be centered on tops due to center base placement. Please specify location as applicable.

DELEN MEETING TABLES

designed by ramsey madsen
and jim contoio

NOTES:

- For custom power unit placement, please contact Customer Service to verify location can be accommodated.

SIN #711-11

POWER UNIT STANDARD LOCATIONS

Rectangle Tables - 1 Power Unit

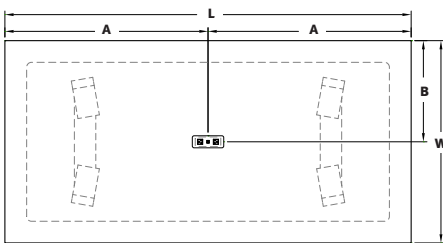

W X L	A	B
36" x 60"	30"	18"
36" x 72"	36"	18"
36" x 84"	42"	18"
36" x 96"	48"	18"
42" x 60"	30"	21"
42" x 72"	36"	21"
42" x 84"	42"	21"
42" x 96"	48"	21"
48" x 84"	42"	24"
48" x 96"	48"	24"
54" x 84"	42"	27"
54" x 96"	48"	27"

For tables 120" and over, single power unit cannot be centered on tops due to center base placement. Please specify location as applicable.

Rectangle Tables - 2 Power Units

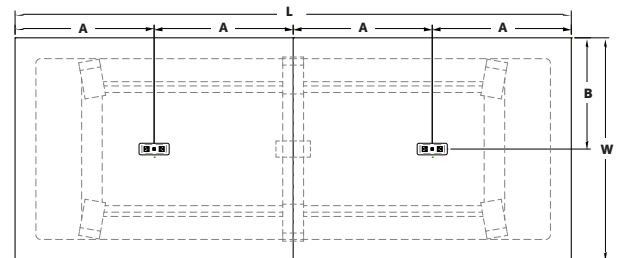
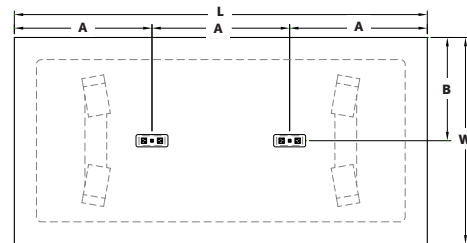

W X L	A	B
36" x 60"	15"	18"
36" x 72"	18"	18"
36" x 84"	21"	18"
36" x 96"	24"	18"
36" x 120"	30"	18"
36" x 144"	36"	18"
36" x 192"	48"	18"
42" x 60"	15"	21"
42" x 72"	18"	21"
42" x 84"	21"	21"
42" x 96"	24"	21"
42" x 120"	30"	21"
42" x 144"	36"	21"
42" x 192"	48"	21"
48" x 84"	21"	24"
48" x 96"	24"	24"
48" x 120"	30"	24"
48" x 144"	36"	24"
48" x 192"	48"	24"
54" x 84"	21"	27"
54" x 96"	24"	27"
54" x 120"	30"	27"
54" x 144"	36"	27"
54" x 192"	48"	27"

NOTES:

- Metal platform base available in #06 Charcoal Grey, #90 Metallic Silver and #92 Polished Aluminum.
- Asymmetrical pentagonal bench features five sides and seats up to four.
- Maximum weight capacity is 350 lbs. per seat position for 120-degree models, 700 lbs. for two-seat models and 1050 lbs. for three-seat units.
- Two-tone upholstery examples and yardage requirements featured on page 2.

SPECIFY:

1. Model number
2. Leg finish
3. Upholstery selection
4. Options, as applicable

ORDERING EXAMPLE:

#6162-NS02B

Two-Seat Bench
Non-Skid Glides

DOMO BENCHES

designed by qdesign

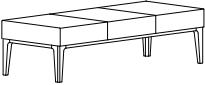
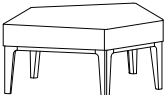

SIN #711-16

MODEL NUMBER	PRODUCT SPECIFICATIONS	FABRIC GRADES							LEATHER GRADES				
		COM	1	2	COL 3	4	5	6	7	8	L1	L2	L3
6162 	Two-Seat Bench W 44 ¹ / ₂ D 27 H 18 2 Yds. 50 lbs. COL 40 Sq. Ft. TB 133 add \$96 List	1469	1583	1610	1658	1707	1753	1801	1845	1894	2114	2276	2433
6163 	Three-Seat Bench W 67 ¹ / ₄ D 27 H 18 2 ³ / ₄ Yds. 70 lbs. COL 55 Sq. Ft. TB 133 add \$132 List	1753	1909	1947	2013	2080	2143	2210	2270	2337	2640	2862	3079
6164 	120-Degree Pentagonal Bench See Dimensions below Seat Height 18 2 ¹ / ₄ Yds. 47 lbs. COL 45 Sq. Ft. TB 133 add \$108 List	1634	1762	1793	1847	1901	1953	2008	2057	2112	2360	2542	2719

Top View

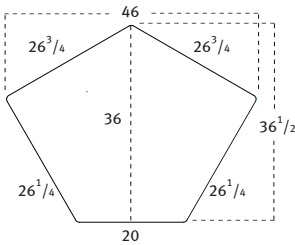

OPTIONS (XXXX - REFERS TO BENCH MODEL NUMBER)

MODEL	DESCRIPTION	LIST
XXXX-NS02B	Non-Skid Glides, 2 and 3-Seat Benches	20
XXXX-NS02C	Non-Skid Glides, 120-Degree Pentagonal Bench	25

DOMO BENCHES

designed by qdesign



UPHOLSTERY COMBINATIONS:

For fabric, vinyl or leather upholstery combinations, refer to the pricing below:

- When combining **two** COM/COV/COL fabrics, or fabrics with the same grade, add \$65 List per unit.
- When combining **three or more** COM/COV/COL fabrics, or fabrics with the same grade, add \$75 List per unit.
- When combining different grades of fabric, price will be based on the highest grade specified.
- Two-tone upholstery examples and yardage requirements for the most common combinations are listed below. Additional combinations available, please contact Customer Service for yardage requirements and pricing.
- Note: Yardage amounts are based on fabric which is plain (i.e. non-directional) and a full 54" wide.
- **Appropriate upholstery code must be included on order.**

SIN #711-16



Code DL19

<u>Model</u>	<u>COM Requirement</u>
6162	Top of Cushion Only = 1 yd. Balance of Bench = 1 yd.

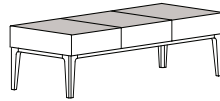

Code DL20

<u>Model</u>	<u>COM Requirement</u>
6163	Top of Cushion Only = 1 ¹ / ₂ yds. Balance of Bench = 1 ¹ / ₂ yds.



Code DL21

<u>Model</u>	<u>COM Requirement</u>
6164	Top of Cushion Only = 1 ¹ / ₄ yds. Balance of Bench = 1 yds.

DOMO LOUNGE

designed by qdesign



SIN #711-16

PRODUCT FEATURES:

- Arm and armless lounge, love seat and sofa models with accompanying ottomans.
- Fixed seat cushion.
- Metal platform base available in #92 Polished Aluminum and the following finishes: #06 Charcoal Grey and #90 Metallic Silver.
- Non-skid glides available for hard surface floors. Please specify “-NS02B” after model number and add \$20 List per unit.
- Swivel-base and mobile lounge chairs also offered.
- Swivel base standard with auto-return feature (Polished Stainless Steel finish only).
- Mobile lounge chairs feature two locking casters in rear and two non-locking casters in front. Casters available with chrome detail only.
- Casters feature semi-soft treads for compatibility on all floor surfaces.
- Optional pull available on back of mobile lounge chairs only. Please specify “-P01” next to model number and add \$50 List per unit. Satin nickel finish.
- Maximum weight capacity: 350 lbs. for lounge chairs, 700 lbs. for love seats and 1000 lbs. for sofas.
- Please refer to page 13 for two-tone upholstery examples, yardage requirements and pricing.
- All dimensions are nominal.

STORAGE SHELF FEATURES (MODEL 6100-SF ONLY):

- $\frac{3}{4}$ " thick storage shelf available below seat.
- Storage shelf clearance is 5" from floor.
- Shelf surface options: Maple, Walnut or White Oak veneer with hardwood edge or laminate with T-mold edge (black or dove grey, please specify).
- All standard and custom wood finishes available.
- For custom wood finishes (to panels, tablets and/or shelf), please add one-time upcharge of \$400 List per color per order.
- For standard laminates, refer to Standard Finish Card.
- For custom laminates, add \$500 List per color per order. Pre-approval required, please contact Customer Service.

ROTATING TABLET:

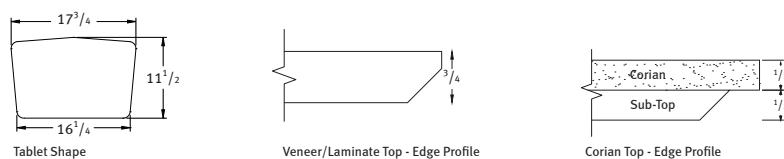

- Available on seating units with arms.
- Tablet size is $17\frac{3}{4}$ " W x $11\frac{1}{2}$ " D x $\frac{3}{4}$ " thick.
- Rotating tablet features 360-degree turning radius and is affixed to top of arm.
- Three tablet surface options: veneer, laminate or Corian.
- Tablet veneer surface offered in Maple, Walnut and White Oak, in all standard and custom wood finishes.
- For custom wood finishes (to panels, tablets and/or shelf), please add one-time upcharge of \$400 List per color per order.
- For standard laminates, refer to Standard Finish Card.
- For custom laminates, add \$500 List per color per order. Pre-approval required, please contact Customer Service.
- Corian available in four standard colors. For non-standard options, please contact Customer Service for pricing.

DOMO LOUNGE

designed by qdesign



SIN #711-16

ROTATING TABLE CONTINUED:

- For maximum durability, a Corian tablet or laminate surface with a clear coat edge finish is recommended.
- Tablet mounting post for connecting tables standard with #91 Chrome finish. #90 Metallic Silver also available, please specify.

CORIAN® COLORS:

Designer White
Linen
Rain Cloud
Witch Hazel

Corian® is a registered trademark of Dupont.

TABLET EDGE/PULL-UP TABLE FINISH SPECIFICATIONS:

- For veneer tops, edge finish will always match the top finish color, unless otherwise specified.
- For standard laminate tops (laminate cannot be applied to the edge):
 - › Wood grain laminates, edge finish will match the laminate top color, unless otherwise specified.
 - › Solid color laminates, edge finish will be natural (clear coat) as standard, unless otherwise specified.
- For Corian tops:
 - › Designer White, Rain Cloud and Linen colors, edge will be white as standard, unless otherwise specified.
 - › Witch Hazel, edge will be natural (clear coat) as standard, unless otherwise specified.
- Edges are also available in all standard wood finishes, please specify. For custom edge finishes, please add one-time upcharge of \$400 List per color, per order.



DOMO LOUNGE

designed by qdesign



SIN #711-16

PRIVACY PANELS:

- Three privacy panel options: private (high), transitional (high to low or low to high), and semi-private (low).
- Private panels measures 51" high from the floor.
- Transitional panels measures 51" high at one end and tapers to 41" at the other end.
- Semi-private panels measures 31" high from the floor.
- Panels available in 2 and 3 seat spans.
- Arm panels available as private and semi-private panels only. Panels match slope of the arm design and are ordered separately.
- Four panel material options: veneer, laminate, whiteboard and upholstered.
- Veneer panels available in Maple, Walnut and White Oak wood species and feature vertical grain direction only.
- All standard and custom wood finishes available.
- For custom wood finishes (to panels, tablets and/or shelf), please add one-time upcharge of \$400 List per color per order.
- Veneer panels require veneer on both sides. As standard, the exposed radius plywood edge will be finished to match specified panel wood finish.
- Laminate panels will have same laminate on both sides as standard. For different laminate selections to the same panel, please contact Customer Service for pricing. If a wood grain laminate is specified, pattern will run horizontal with exposed plywood edge finished to match laminate selection. If a non-wood grain laminate is specified, the exposed plywood edge will be finished in a clear coat as standard.
- Whiteboard panels will have same whiteboard material on both sides as standard. Also available with whiteboard surface on one side and a laminate surface on the other side, please specify and reference pricing for the whiteboard panels. The exposed plywood edge will be finished in a clear coat as standard.
- Upholstered panels available in fabric, vinyl or faux leather.
- All panels ordered separately from seating units.
- Field-installation required.
- Panels cannot be retrofit to previously ordered seating units.
- All dimensions are nominal.

DOMO LOUNGE

designed by qdesign



NOTES:

- Mobile lounge chairs feature two locking casters in rear and two non-locking casters in front. Casters feature semi-soft treads for compatibility on all floor surfaces.
- Lounge chair swivel base standard with auto-return feature (Polished Stainless Steel finish only).
- Shelf surface options: Maple, Walnut and White Oak veneer with hardwood edge or laminate with T-mold edge (black or dove grey, please specify).
- Refer to page 13 for two-tone upholstery examples and yardage requirements.

SPECIFY:

1. Model number
2. Upholstery selection
3. Options, as applicable

ORDERING EXAMPLE:

#6100-SF-TAL05-CO

Mobile Lounge Chair
Corian Tablet, Left

SIN #711-16

MODEL NUMBER	PRODUCT SPECIFICATIONS	FABRIC GRADES							LEATHER GRADES							
		COM	1	2	COL			4	5	6	7	8	L1	L2	L3	
6100-C	Mobile Lounge Chair, Casters W 31 D 26 ¹ / ₂ H 31 Seat Height 18 Inside Seat Width 24 Inside Seat Depth 19 Arm Height 29 4 ¹ / ₂ Yds. 66 lbs. COL 90 Sq. Ft. TB 133, add \$216 List	1470	1726	1787	1896	2004	2108	2217	2316	2425	2921	3285	3639			
6100-SF	Mobile Lounge Chair, Casters with Shelf W 31 D 26 ¹ / ₂ H 31 Seat Height 18 Inside Seat Width 24 Inside Seat Depth 19 Arm Height 29 4 ¹ / ₂ Yds. 103 lbs. COL 90 Sq. Ft. TB 133, add \$216 List	1735	1991	2052	2161	2269	2373	2482	2581	2690	3186	3550	3904			
6100-AR	Swivel Lounge Chair, Auto-Return W 31 D 26 ¹ / ₂ H 31 Seat Height 18 Inside Seat Width 24 Inside Seat Depth 19 Arm Height 29 4 ¹ / ₂ Yds. 103 lbs. COL 90 Sq. Ft. TB 133, add \$216 List	1746	2002	2063	2172	2280	2384	2493	2592	2701	3197	3561	3915			

OPTIONS (XXXX - REFERS TO CHAIR MODEL NUMBER)

MODEL	DESCRIPTION	LIST
XXXX-TAR05	Veneer/Laminate Rotating Tablet, Right (as seated)	372
XXXX-TAL05	Veneer/Laminate Rotating Tablet, Left (as seated)	372
XXXX-TAR05-CO	Corian Rotating Tablet, Right (as seated)	674
XXXX-TAL05-CO	Corian Rotating Tablet, Left (as seated)	674
XXXX-P01	Pull (available on models #6100-C and #6100-SF only)	50

Q S = Available on Quick-Ship Program, Wood or Metal Frame (Metallic Silver finish only).

NOTES:

- Metal platform base available in #92 Polished Aluminum, #06 Charcoal Grey and #90 Metallic Silver.
- Refer to pages 9-11 for privacy panel options.
- Refer to page 13 for two-tone upholstery examples and yardage requirements.

SPECIFY:

1. Model number
2. Metal base finish
3. Upholstery selection
4. Options, as applicable

ORDERING EXAMPLE:

#6101-TAR05-NS02B



Lounge Chair
Veneer Tablet, Right
Non-Skid Glides

**DOMO
LOUNGE**

designed by qdesign

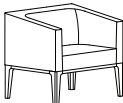

SIN #711-16

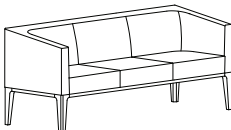
MODEL NUMBER	PRODUCT SPECIFICATIONS	FABRIC GRADES							LEATHER GRADES				
		COM	1	2	COL 3	4	5	6	7	8	L1	L2	L3
6101 	Lounge Chair, Arms W 30 ¹ / ₂ D 26 ¹ / ₂ H 31 Seat Height 18 Inside Seat Width 24 Inside Seat Depth 19 Arm Height 29 4 Yds. 60 lbs. COL 80 Sq. Ft. TB 133, add \$192 List	1586	1813	1868	1964	2061	2153	2250	2338	2435	2876	3199	3514
6102 	Love Seat, Arms W 52 ¹ / ₄ D 26 ¹ / ₂ H 31 Seat Height 18 Inside Seat Width 46 Inside Seat Depth 19 Arm Height 29 5 Yds. 100 lbs. COL 100 Sq. Ft. TB 133, add \$240 List	2091	2375	2443	2564	2685	2800	2921	3031	3152	3703	4107	4501
6103 	Sofa, Arms W 75 D 26 ¹ / ₂ H 31 Seat Height 18 Inside Seat Width 69 Inside Seat Depth 19 Arm Height 29 6 ¹ / ₂ Yds. 130 lbs. COL 130 Sq. Ft. TB 133, add \$312 List	2756	3125	3214	3371	3528	3678	3835	3978	4135	4852	5377	5889

OPTIONS (XXXX - REFERS TO CHAIR MODEL NUMBER)

MODEL	DESCRIPTION	LIST
XXXX-TAR05	Veneer/Laminate Rotating Tablet, Right (as seated)	372
XXXX-TAL05	Veneer/Laminate Rotating Tablet, Left (as seated)	372
XXXX-TAR05-CO	Corian Rotating Tablet, Right (as seated)	674
XXXX-TAL05-CO	Corian Rotating Tablet, Left (as seated)	674
XXXX-NS02B	Non-Skid Glides	20

DOMO LOUNGE

designed by qdesign



SIN #711-16

NOTES:

- Metal platform base available in #92 Polished Aluminum, #06 Charcoal Grey and #90 Metallic Silver.
- Refer to pages 9-11 for privacy panel options.
- Refer to page 13 for two-tone upholstery examples and yardage requirements.

SPECIFY:

1. Model number
2. Metal base finish
3. Upholstery selection
4. Options, as applicable

ORDERING EXAMPLE:

#6130-NS02B

Sofa
Non-Skid Glides

MODEL NUMBER	PRODUCT SPECIFICATIONS	FABRIC GRADES							LEATHER GRADES							
		COM	1	2	COL			3	4	5	6	7	8	L1	L2	L3
6110	Lounge Chair, Armless W 23 D 26 ¹ / ₂ H 31 Seat Height 18 Inside Seat Width 22 ¹ / ₂ Inside Seat Depth 19 2 Yds. 42 lbs. COL 40 Sq. Ft. TB 133, add \$96 List	1351	1465	1492	1540	1589	1635	1683	1727	1776	1996	2158	2315			
6120	Love Seat, Armless W 45 ¹ / ₂ D 26 ¹ / ₂ H 31 Seat Height 18 Inside Seat Width 45 ¹ / ₂ Inside Seat Depth 19 3 ³ / ₄ Yds. 75 lbs. COL 75 Sq. Ft. TB 133, add \$180 List	1904	2117	2168	2259	2349	2436	2527	2609	2700	3113	3416	3712			
6130	Sofa, Armless W 67 ¹ / ₂ D 26 ¹ / ₂ H 31 Seat Height 18 Inside Seat Width 67 ¹ / ₂ Inside Seat Depth 19 5 ¹ / ₄ Yds. 102 lbs. COL 105 Sq. Ft. TB 133, add \$252 List	2523	2821	2893	3020	3146	3268	3394	3510	3637	4216	4640	5054			

OPTIONS (XXXX - REFERS TO CHAIR MODEL NUMBER)

MODEL	DESCRIPTION	LIST
XXXX-NS02B	Non-Skid Glides	20

NOTES:

- Metal platform base available in #92 Polished Aluminum, #06 Charcoal Grey and #90 Metallic Silver.
- Tablet is affixed to top of arm only.
- Refer to pages 9-11 for privacy panel options.
- Refer to page 13 for two-tone upholstery examples and yardage requirements.

SPECIFY:

1. Model number
2. Metal base finish
3. Upholstery selection
4. Options, as applicable

ORDERING EXAMPLE:

#6110-BR-NS02B



Lounge Chair, Right Side Bench
Non-Skid Glides

**DOMO
LOUNGE**

designed by qdesign

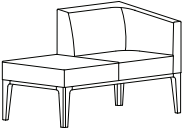
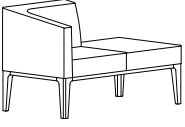

SIN #711-16

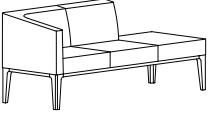
MODEL NUMBER	PRODUCT SPECIFICATIONS	FABRIC GRADES								LEATHER GRADES			
		COM	1	2	COL			7	8	L1	L2	L3	
6110-BR 	Lounge Chair with Right Side Bench Seat (as seated) W 48 D 26 ¹ / ₂ H 31 Seat Height 18 Inside Seat Width 45 Inside Seat Depth 19 Arm Height 29 3 ¹ / ₂ Yds. 70 lbs. COL 70 Sq. Ft. TB 133, add \$168 List	1728	1927	1975	2059	2144	2225	2309	2386	2471	2857	3140	3415
		1728	1927	1975	2059	2144	2225	2309	2386	2471	2857	3140	3415
6110-BL 	Lounge Chair with Left Side Bench Seat (as seated) W 48 D 26 ¹ / ₂ H 31 Seat Height 18 Inside Seat Width 45 Inside Seat Depth 19 Arm Height 29 3 ¹ / ₂ Yds. 70 lbs. COL 70 Sq. Ft. TB 133, add \$168 List	1728	1927	1975	2059	2144	2225	2309	2386	2471	2857	3140	3415
		1728	1927	1975	2059	2144	2225	2309	2386	2471	2857	3140	3415
6120-BR 	Love Seat with Right Side Bench Seat (as seated) W 71 D 26 ¹ / ₂ H 31 Seat Height 18 Inside Seat Width 67 Inside Seat Depth 19 Arm Height 29 5 ¹ / ₄ Yds. 105 lbs. COL 105 Sq. Ft. TB 133, add \$252 List	2280	2578	2650	2777	2903	3025	3151	3267	3394	3973	4397	4811
		2280	2578	2650	2777	2903	3025	3151	3267	3394	3973	4397	4811
6120-BL 	Love Seat with Left Side Bench Seat (as seated) W 71 D 26 ¹ / ₂ H 31 Seat Height 18 Inside Seat Width 67 Inside Seat Depth 19 Arm Height 29 5 ¹ / ₄ Yds. 105 lbs. COL 105 Sq. Ft. TB 133, add \$252 List	2280	2578	2650	2777	2903	3025	3151	3267	3394	3973	4397	4811
		2280	2578	2650	2777	2903	3025	3151	3267	3394	3973	4397	4811

OPTIONS (XXXX - REFERS TO CHAIR MODEL NUMBER)

MODEL	DESCRIPTION	LIST
XXXX-TAR05	Veneer/Laminate Rotating Tablet, Right (as seated)	372
XXXX-TAL05	Veneer/Laminate Rotating Tablet, Left (as seated)	372
XXXX-TAR05-CO	Corian Rotating Tablet, Right (as seated)	674
XXXX-TAL05-CO	Corian Rotating Tablet, Left (as seated)	674
XXXX-NS02B	Non-Skid Glides	20

DOMO LOUNGE

designed by qdesign



SIN #711-16

NOTES:

- Mobile ottoman features two locking casters in rear and two non-locking casters in front. Casters available with chrome detail only.
- Casters feature semi-soft treads for compatibility on all floor surfaces.
- Ottoman swivel base standard with auto-return feature.
- Swivel base available in Polished Stainless Steel only.
- Maximum weight capacity is 350 lbs.
- Refer to page 13 for two-tone upholstery examples and yardage requirements.

SPECIFY:

1. Model number
2. Upholstery selection

ORDERING EXAMPLE:

#6150-S
Ottoman, Swivel Base

MODEL NUMBER	PRODUCT SPECIFICATIONS	FABRIC GRADES							LEATHER GRADES				
		COM	1	2	COL 3	4	5	6	7	8	L1	L2	L3
6150-C	Ottoman, Casters W 21 D 24 H 18 2 Yds. 30 lbs. COL 40 Sq. Ft. TB 133, add \$96 List	1113	1227	1254	1302	1351	1397	1445	1489	1538	1758	1920	2077
6150-S	Ottoman, Swivel Base, Auto-Return W 21 D 24 H 18 2 Yds. 72 lbs. COL 40 Sq. Ft. TB 133, add \$96List	1290	1404	1431	1479	1528	1574	1622	1666	1715	1935	2097	2254

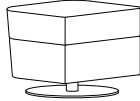
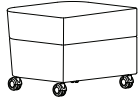

Top View

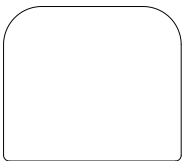

DOMO LOUNGE

designed by qdesign



SIN #711-16

PRIVACY PANEL DIMENSIONS

PANEL HEIGHTS:

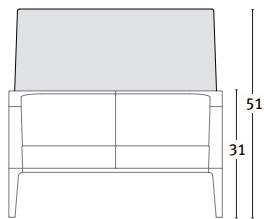

FS = Private Panel (high)

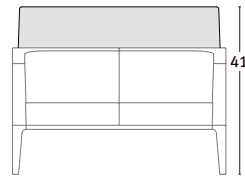

HS = Semi-Private Panel (low)

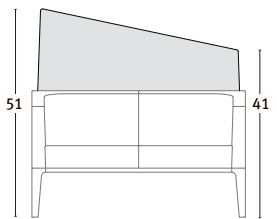

TSL = Transitional Panel (high to low)

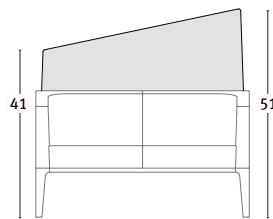

TSR = Transitional Panel (low to high)

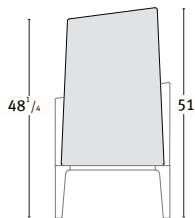

AFR/AFL = Private Arm Panel (high)

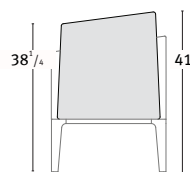

AHR/AHL = Semi-Private Arm Panel (low)

PANEL WIDTHS*:

Model	Top	Bottom
2-Seat Span, No Arms	40 ¹ / ₂	42 ¹ / ₂
2-Seat Span, One Arm	44 ¹ / ₂	46 ¹ / ₂
2-Seat Span, Two Arms	47 ³ / ₄	49 ³ / ₄
3-Seat Span, No Arms	63 ¹ / ₄	65 ¹ / ₄
3-Seat Span, One Arm	67 ¹ / ₄	69 ¹ / ₄
3-Seat Span, Two Arms	71 ³ / ₄	73 ³ / ₄
Arm Panel	22	24 ¹ / ₂

*Dimensions are nominal and vary slightly between panel styles.

DOMO LOUNGE

designed by qdesign



NOTES:

- Veneer panels available in Maple, Walnut and White Oak wood species.
- Laminate panels will feature exposed radius-ed plywood edge, finished in a clear coat as standard. To match edge finish to standard wood grain laminates, please specify. To match edge finish to solid color laminates, please contact Customer Service for pricing.
- Whiteboard panels are double-sided with exposed radius-ed plywood edge, finished in a clear coat as standard.
- Panels ordered separately from seating units.
- Panels cannot be retrofit to previously ordered seating units.
- Field-installation required.

SPECIFY:

1. Model number
2. Panel finish

ORDERING EXAMPLE:

#FS-2AA-L

2-Seat Span with Two Arms
Laminate Finish

SIN #711-16

DESCRIPTION	MODEL NUMBER	VENEER (-V)	LAMINATE (-L)	WHITEBOARD (-W)	WEIGHT
PRIVATE BACK PANEL (51" HIGH)					
2-SEAT SPAN, NO ARMS	FS-2(-)	1079	1079	1187	20
2-SEAT SPAN WITH ONE ARM	FS-2A(-)	1090	1090	1199	20
2-SEAT SPAN WITH TWO ARMS	FS-2AA(-)	1103	1103	1213	20
3-SEAT SPAN, NO ARMS	FS-3(-)	1400	1400	1540	28
3-SEAT SPAN WITH ONE ARM	FS-3A(-)	1412	1412	1551	28
3-SEAT SPAN WITH TWO ARMS	FS-3AA(-)	1423	1423	1565	28
TRANSITIONAL BACK PANEL (51" LEFT TO 41" RIGHT, AS SEATED)					
2-SEAT SPAN, NO ARMS	TSL-2(-)	1079	1079	1187	18
2-SEAT SPAN WITH ONE ARM	TSL-2A(-)	1090	1090	1199	18
2-SEAT SPAN WITH TWO ARMS	TSL-2AA(-)	1103	1103	1213	18
3-SEAT SPAN, NO ARMS	TSL-3(-)	1400	1400	1540	26
3-SEAT SPAN WITH ONE ARM	TSL-3A(-)	1412	1412	1551	26
3-SEAT SPAN WITH TWO ARMS	TSL-3AA(-)	1423	1423	1565	26
TRANSITIONAL BACK PANEL (41" LEFT TO 51" RIGHT, AS SEATED)					
2-SEAT SPAN, NO ARMS	TSR-2(-)	1079	1079	1187	18
2-SEAT SPAN WITH ONE ARM	TSR-2A(-)	1090	1090	1199	18
2-SEAT SPAN WITH TWO ARMS	TSR-2AA(-)	1103	1103	1213	18
3-SEAT SPAN, NO ARMS	TSR-3(-)	1400	1400	1540	26
3-SEAT SPAN WITH ONE ARM	TSR-3A(-)	1412	1412	1551	26
3-SEAT SPAN WITH TWO ARMS	TSR-3AA(-)	1423	1423	1565	26
SEMI-PRIVATE BACK PANEL (41" HIGH)					
2-SEAT SPAN, NO ARMS	HS-2(-)	989	989	1085	13
2-SEAT SPAN WITH ONE ARM	HS-2A(-)	999	999	1100	13
2-SEAT SPAN WITH TWO ARMS	HS-2AA(-)	1010	1010	1111	13
3-SEAT SPAN, NO ARMS	HS-3(-)	1280	1280	1409	19
3-SEAT SPAN WITH ONE ARM	HS-3A(-)	1293	1293	1420	19
3-SEAT SPAN WITH TWO ARMS	HS-3AA(-)	1304	1304	1434	19
PRIVATE ARM PANEL (51" HIGH)					
RIGHT, AS SEATED	AFR(-)	646	646	710	9
LEFT, AS SEATED	AFL(-)	646	646	710	9
SEMI-PRIVATE ARM PANEL (41" HIGH)					
RIGHT, AS SEATED	AHR(-)	540	540	595	7
LEFT, AS SEATED	AHL(-)	540	540	595	7

NOTES:

- Upholstered panels available in fabric, vinyl or faux leather.
- Panels ordered separately from seating units.
- Panels cannot be retrofit to previously ordered seating units.
- Field-installation required.

SPECIFY:

1. Model number
2. Panel fabric selection

ORDERING EXAMPLE:

#TSL-3-U
3-Seat Span, No Arms
Upholstered Panel

**DOMO
LOUNGE**

designed by qdesign



SIN #711-16

UPHOLSTERY PANELS		FABRIC GRADES										
DESCRIPTION	YARDS	MODEL NUMBER	COM	1	2	COL 3	4	5	6	7	8	WEIGHT
PRIVATE BACK PANEL (51" HIGH)												
2-SEAT SPAN, NO ARMS	2 ³ / ₄	FS-2-U	704	860	898	964	1031	1094	1161	1221	1288	23
2-SEAT SPAN WITH ONE ARM	2 ³ / ₄	FS-2A-U	710	866	904	970	1037	1100	1167	1227	1294	23
2-SEAT SPAN WITH TWO ARMS	4 ³ / ₄	FS-2AA-U	718	988	1053	1167	1282	1392	1507	1611	1726	23
3-SEAT SPAN, NO ARMS	4	FS-3-U	845	1072	1127	1223	1320	1412	1509	1597	1694	32
3-SEAT SPAN WITH ONE ARM	4 ¹ / ₄	FS-3A-U	851	1092	1150	1253	1356	1454	1557	1650	1753	32
3-SEAT SPAN WITH TWO ARMS	4 ³ / ₄	FS-3AA-U	856	1126	1191	1305	1420	1530	1645	1749	1864	32
TRANSITIONAL BACK PANEL (51" LEFT TO 41" RIGHT, AS SEATED)												
2-SEAT SPAN, NO ARMS	2 ³ / ₄	TSL-2-U	704	860	898	964	1031	1094	1161	1221	1288	21
2-SEAT SPAN WITH ONE ARM	3	TSL-2A-U	710	881	922	994	1066	1136	1208	1274	1347	21
2-SEAT SPAN WITH TWO ARMS	4 ¹ / ₄	TSL-2AA-U	718	959	1017	1120	1223	1321	1424	1517	1620	21
3-SEAT SPAN, NO ARMS	4	TSL-3-U	845	1072	1127	1223	1320	1412	1509	1597	1694	30
3-SEAT SPAN WITH ONE ARM	4 ¹ / ₄	TSL-3A-U	851	1092	1150	1253	1356	1454	1557	1650	1753	30
3-SEAT SPAN WITH TWO ARMS	4 ¹ / ₂	TSL-3AA-U	856	1112	1173	1282	1390	1494	1603	1702	1811	30
TRANSITIONAL BACK PANEL (41" LEFT TO 51" RIGHT, AS SEATED)												
2-SEAT SPAN, NO ARMS	2 ³ / ₄	TSR-2-U	704	860	898	964	1031	1094	1161	1221	1288	21
2-SEAT SPAN WITH ONE ARM	3	TSR-2A-U	710	881	922	994	1066	1136	1208	1274	1347	21
2-SEAT SPAN WITH TWO ARMS	4 ¹ / ₄	TSR-2AA-U	718	959	1017	1120	1223	1321	1424	1517	1620	21
3-SEAT SPAN, NO ARMS	4	TSR-3-U	845	1072	1127	1223	1320	1412	1509	1597	1694	30
3-SEAT SPAN WITH ONE ARM	4 ¹ / ₄	TSR-3A-U	851	1092	1150	1253	1356	1454	1557	1650	1753	30
3-SEAT SPAN WITH TWO ARMS	4 ¹ / ₂	TSR-3AA-U	856	1112	1173	1282	1390	1494	1603	1702	1811	30
SEMI-PRIVATE BACK PANEL (41" HIGH)												
2-SEAT SPAN, NO ARMS	2 ³ / ₄	HS-2-U	648	804	842	908	975	1038	1105	1165	1232	15
2-SEAT SPAN WITH ONE ARM	3	HS-2A-U	654	825	866	938	1010	1080	1152	1218	1291	15
2-SEAT SPAN WITH TWO ARMS	3 ¹ / ₄	HS-2AA-U	660	845	889	968	1046	1121	1200	1271	1350	15
3-SEAT SPAN, NO ARMS	4	HS-3-U	776	1003	1058	1154	1251	1343	1440	1528	1625	22
3-SEAT SPAN WITH ONE ARM	4 ¹ / ₄	HS-3A-U	783	1024	1082	1185	1288	1386	1489	1582	1685	22
3-SEAT SPAN WITH TWO ARMS	4 ¹ / ₂	HS-3AA-U	788	1044	1105	1214	1322	1426	1535	1634	1743	22
PRIVATE ARM PANEL (51" HIGH)												
RIGHT, AS SEATED	1 ¹ / ₂	AFR-U	488	574	594	630	666	701	737	770	807	12
LEFT, AS SEATED	1 ¹ / ₂	AFL-U	488	574	594	630	666	701	737	770	807	12
SEMI-PRIVATE ARM PANEL (41" HIGH)												
RIGHT, AS SEATED	1 ¹ / ₂	AHR-U	488	574	594	630	666	701	737	770	807	9
LEFT, AS SEATED	1 ¹ / ₂	AHL-U	488	574	594	630	666	701	737	770	807	9

DOMO LOUNGE

designed by qdesign



SIN #711-16

NOTES:

- Pull-up table available in Maple, Walnut and White Oak veneer, as well as laminate and Corian.
- For maximum durability, a Corian tablet or laminate surface with a clear coat edge finish is recommended.
- Refer to page 2 for edge specifications.
- Table column will match base plate as standard, unless otherwise specified. For Stainless Steel Clad base plate, column will be #91 Chrome.

SPECIFY:

1. Model number
2. Wood species
3. Wood finish
4. Edge finish, as applicable
5. Base finish

ORDERING EXAMPLE:

#6191-CO
Pull-Up Table
Corian Top

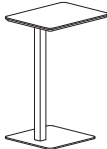
MODEL NUMBER	PRODUCT SPECIFICATIONS	TABLE TOP FINISH	
		VENEER OR LAMINATE	CORIAN (-CO)
6191 	Offset Pull-Up Table Overall Dimensions: 18" W x 14" D x 27" H 3/4" Table Top Thickness Base Plate Dimensions: 14" W x 14" L x 1/2" thick Square Column Dimensions: 2 3/8" x 2 3/8" Metal Tube 25 lbs.	851	1088

Corian Top Colors:

- Designer White
- Linen
- Rain Cloud
- Witch Hazel

Base Finish Colors:

- Stainless Steel Clad (base plate only)
- #91 Chrome (table column only)
- #06 Charcoal
- #90 Metallic Silver

UPHOLSTERY COMBINATIONS:

For fabric, vinyl or leather upholstery combinations, refer to the pricing below:

- When combining **two** COM/COV/COL fabrics, or fabrics with the same grade, add the following (per unit):
 - › \$65 List for lounge chairs
 - › \$105 List for love seats
 - › \$130 List for sofas
- When combining **three or more** COM/COV/COL fabrics, or fabrics with the same grade, add the following (per unit):
 - › \$75 List for lounge chairs
 - › \$115 List for love seats
 - › \$140 List for sofas
- When combining different grades of fabric, price will be based on the highest grade specified.
- Two-tone upholstery examples and yardage requirements for the most common combinations are listed below. Additional combinations available, please contact Customer Service for yardage requirements and pricing.
- Note: Yardage amounts are based on fabric which is plain (i.e. non-directional) and a full 54" wide.
- **Appropriate upholstery code must be included on order.**

DOMO
LOUNGE

designed by qdesign



SIN #711-16



Code DL1
Model COM Requirement
6100 Seat Cushion Only = 1 yd.
Balance of Chair = 4 yds.



Code DL2
Model COM Requirement
6100 Seat Cushion &
Seat Box = 1¹/₄ yds.
Balance of Chair = 3¹/₂ yds.

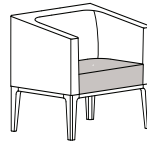

Code DL3
Model COM Requirement
6101 Seat Cushion Only = 1¹/₄ yds.
Balance of Chair = 3¹/₂ yds.

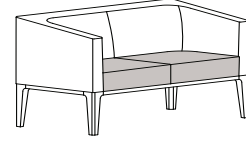

Code DL4
Model COM Requirement
6102 Seat Cushion Only = 1¹/₂ yds.
Balance of Love Seat = 3¹/₂ yds.

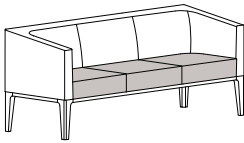

Code DL5
Model COM Requirement
6103 Seat Cushion Only = 2¹/₂ yds.
Balance of Sofa = 4 yds.

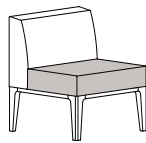

Code DL6
Model COM Requirement
6110 Seat Cushion Only = 1 yd.
Balance of Chair = 1¹/₄ yds.

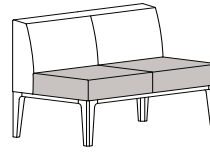

Code DL10
Model COM Requirement
6120 Seat Cushion Only = 1³/₄ yds.
Balance of Love Seat = 2 yds.

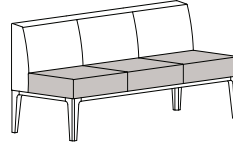

Code DL14
Model COM Requirement
6130 Seat Cushion Only = 2¹/₂ yds.
Balance of Sofa = 2³/₄ yds.

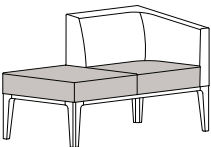

Code DL8
Models COM Requirement
6110-BR Seat Cushion &
6110-BL Bench Seat Only = 1³/₄ yds.
Balance of Unit = 2 yds.

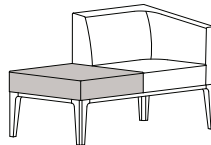

Code DL9
Models COM Requirement
6110-BL Bench Seat Only = 1 yd.
6110-BR Balance of Unit = 2³/₄ yds.

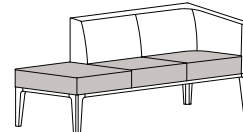

Code DL12
Models COM Requirement
6120-BR Seat Cushion &
6120-BL Bench Seat Only = 2¹/₂ yds.
Balance of Unit = 2³/₄ yds.

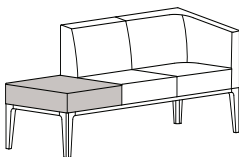

Code DL13
Models COM Requirement
6120-BL Bench Cushion Only = 1 yd.
6120-BR Balance of Unit = 4¹/₄ yds.

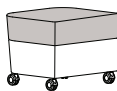

Code DL18
Model COM Requirement
6150 Seat Cushion Only = 1¹/₄ yds.
Balance of Ottoman = 3¹/₄ yds.

DOMO MODULAR

designed by qdesign



SIN #711-16

PRODUCT FEATURES:

- Arm and armless lounge, love seat and sofas.
- Fixed seat cushion.
- Metal platform base available in #92 Polished Aluminum and the following finishes: #06 Charcoal Grey and #90 Metallic Silver.
- Non-skid glides available for hard surface floors. Please specify “-NS02B” after model number and add \$20 List per unit, or as noted.
- Maximum weight capacity is 350 lbs. for lounge chairs (or per individual seat as applicable), 700 lbs. for love seats and 1000 lbs. for sofas.
- Please refer to pages 23-24 for two-tone upholstery examples, yardage requirements and pricing.
- All dimensions are nominal.

CORNER UNIT PRODUCT FEATURES:

- **Note: Upholstery direction must be specified on corner and 120-degree upholstered units when patterned fabrics are selected. In the absence of specific instructions, Arcadia reserves the right to upholster units at our discretion.**

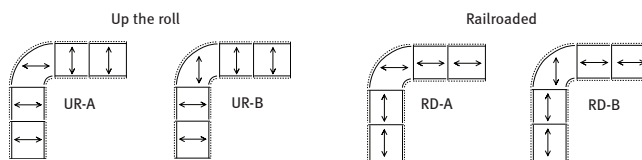

PRIVACY PANELS:

- Three privacy panel options: private (high), transitional (high to low or low to high), and semi-private (low).
- Private panels measures 51" high from the floor.
- Transitional panels measures 51" high at one end and tapers to 41" at the other end.
- Semi-private panels measures 31" high from the floor.
- Panels available in 2 and 3 seat spans.
- Arm panels available as private and semi-private panels only. Panels match slope of the arm design and are ordered separately.
- Four panel material options: veneer, laminate, whiteboard and upholstered.
- Veneer panels available in Maple, Walnut and White Oak wood species and feature vertical grain direction only.
- All standard and custom wood finishes available.
- For custom wood finishes (to panels, tables, tablets and/or shelf), please add one-time upcharge of \$400 List per color per order.
- Veneer panels require veneer on both sides. As standard, the exposed radius plywood edge will be finished to match specified panel wood finish.
- Laminate panels will have same laminate on both sides as standard. For different laminate selections to the same panel, please contact Customer Service for pricing. If a wood grain laminate is specified, pattern will run horizontal with exposed plywood edge finished to match laminate selection. If a non-wood grain laminate is specified, the exposed plywood edge will be finished in a clear coat as standard.
- Whiteboard panels will have same whiteboard material on both sides as standard. Also available with whiteboard surface on one side and a laminate surface on the other side, please specify and reference pricing for the whiteboard panels. The exposed plywood edge will be finished in a clear coat as standard.
- Upholstered panels available in fabric, vinyl or faux leather.
- All panels ordered separately from seating units.
- Field-installation required.
- Panels cannot be retrofit to previously ordered seating units.
- **Note: Layout drawings or sketch is required with panel order.**
- All dimensions are nominal.

DOMO MODULAR

designed by qdesign



SIN #711-16

CONNECTING TABLES:

- Connecting in-line, corner and end tables available.
- 3" table top thickness.
- Three table surface options: veneer, laminate or Corian.
- Veneer available in Maple, Walnut and White Oak.
- All standard and custom wood finishes available.
- For custom wood finishes (to panels, tables and/or tablets), please add one-time upcharge of \$400 List per color per order.
- Table with veneer top, edge finish will match top finish, unless otherwise specified.
- For standard laminates, refer to Standard Finish Card.
- For custom laminates, add \$500 List per color per order. Pre-approval required, please contact Customer Service.
- Table with standard laminate top, edge finish will be as follows (laminate cannot be applied to edge):
 - › Wood grain laminate, edge finish will match laminate top color, unless otherwise specified.
 - › Solid laminate colors, wood edge species and finish selection from our standard offering must be specified .
- For Corian top, specify "-CO" next to model number. Corian top is affixed to table top surface increasing overall table height by 1/2". Please note that a 1/8" reveal will be present.
- Corian top available in four standard colors. For non-standard colors, please contact Customer Service for pricing.
- **Table with Corian top, wood edge species and finish selection must be specified.**
- Metal platform base available in #92 Polished Aluminum and the finishes: #06 Charcoal Grey and #90 Metallic Silver.
- All dimensions are nominal.

CORIAN® COLORS:

Designer White
Linen
Rain Cloud
Witch Hazel

Corian® is a registered trademark of Dupont.

DOMO MODULAR

designed by qdesign



SIN #711-16

ROTATING TABLET:

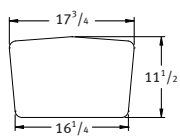

Tablet Shape



Veneer/Laminate Top - Edge Profile

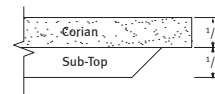

Corian Top - Edge Profile

- Available on all seating units with arms and select connecting tables.
- Tablet size is 17³/₄" W x 11¹/₂" D x 3³/₄" thick.
- Rotating tablet features 360-degree turning radius and is affixed to top of arm.
- Three tablet surface options: veneer, laminate or Corian.
- Tablet veneer surface offered in Maple, Walnut and White Oak, in all standard and custom wood finishes.
- For custom wood finishes (to panels, tables and/or tablets), please add one-time upcharge of \$400 List per color per order.
- For standard laminates, refer to Standard Finish Card.
- For custom laminates, add \$500 List per color per order. Pre-approval required, please contact Customer Service.
- Corian available in four standard colors. For non-standard options, please contact Customer Service for pricing.
- For maximum durability, a Corian tablet or laminate surface with a clear coat edge finish is recommended.
- Tablet mounting post for connecting tables standard with #91 Chrome finish. #90 Metallic Silver also available, please specify.

TABLET/PULL-UP TABLE EDGE FINISH SPECIFICATIONS:

- For veneer tops, edge finish will always match the top finish color, unless otherwise specified.
- For standard laminate tops (laminate cannot be applied to the edge):
 - › Wood grain laminates, edge finish will match the laminate top color, unless otherwise specified.
 - › Solid color laminates, edge finish will be natural (clear coat) as standard, unless otherwise specified.
- For Corian tops:
 - › Designer White, Rain Cloud and Linen colors, edge will be white as standard, unless otherwise specified.
 - › Witch Hazel, edge will be natural (clear coat) as standard, unless otherwise specified.
- Edges are also available in all standard wood finishes, please specify. For custom edge finishes, please add one-time upcharge of \$400 List per color, per order.

DOMO MODULAR

designed by qdesign



SIN #711-16

POWER UNITS:

- Available on all tables.
- PB1 and PB2 dimensions: 5³/₄" W x 2¹/₂" D
- PB3 dimensions: 6¹/₂" W x 2¹/₂" D
- Metallic Silver or White finish with 108" electrical cord.
- UL listed.



PB1

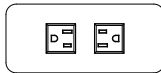

PB2



PB3

- PB1 unit features one outlet and two USB charging ports.
- PB2 unit features two outlets.
- PB3 unit features two outlets and two USB charging ports.

MODULAR ARRANGEMENTS:

- Optional ganging bracket available, please specify "GC03" with quantity and add \$75 List per set. One set contains two brackets for connecting two units together.
- Field assembly required.

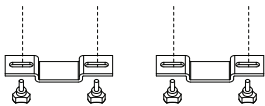

NOTES:

- Metal platform base available in #92 Polished Aluminum, #06 Charcoal Grey and #90 Metallic Silver.
- Refer to pages 16-20 for privacy panel options.
- Refer to page 23 for two-tone upholstery examples and yardage requirements.

SPECIFY:

1. Model number
2. Metal base finish
3. Upholstery selection
4. Options, as applicable

Modular arrangements with privacy panels, please include layout drawings or sketch with order.

ORDERING EXAMPLE:

#6101-TAR05-NS02B

Lounge Chair
Veneer Tablet, Right
Non-Skid Glides

**DOMO
MODULAR**

designed by qdesign

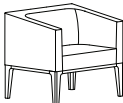
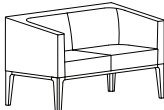
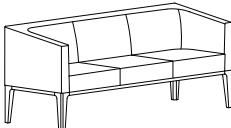

SIN #711-16

MODEL NUMBER	PRODUCT SPECIFICATIONS	FABRIC GRADES								LEATHER GRADES			
		COM	1	2	COL			7	8	L1	L2	L3	
6101 	Lounge Chair, Arms W 30 ¹ / ₂ D 26 ¹ / ₂ H 31 Seat Height 18 Inside Seat Width 24 Inside Seat Depth 19 Arm Height 29 4 Yds. 60 lbs. COL 80 Sq. Ft. TB 133, add \$192 List	1586	1813	1868	1964	2061	2153	2250	2338	2435	2876	3199	3514
6102 	Love Seat, Arms W 52 ¹ / ₄ D 26 ¹ / ₂ H 31 Seat Height 18 Inside Seat Width 46 Inside Seat Depth 19 Arm Height 29 5 Yds. 100 lbs. COL 100 Sq. Ft. TB 133, add \$240 List	2091	2375	2443	2564	2685	2800	2921	3031	3152	3703	4107	4501
6103 	Sofa, Arms W 75 D 26 ¹ / ₂ H 31 Seat Height 18 Inside Seat Width 69 Inside Seat Depth 19 Arm Height 29 6 ¹ / ₂ Yds. 130 lbs. COL 130 Sq. Ft. TB 133, add \$312 List	2756	3125	3214	3371	3528	3678	3835	3978	4135	4852	5377	5889

OPTIONS (XXXX - REFERS TO CHAIR MODEL NUMBER)

MODEL	DESCRIPTION	LIST
XXXX-TAR05	Veneer/Laminate Rotating Tablet, Right (as seated)	372
XXXX-TAL05	Veneer/Laminate Rotating Tablet, Left (as seated)	372
XXXX-TAR05-CO	Corian Rotating Tablet, Right (as seated)	674
XXXX-TAL05-CO	Corian Rotating Tablet, Left (as seated)	674
XXXX-NS02B	Non-Skid Glides	20

DOMO MODULAR

designed by qdesign



SIN #711-16

NOTES:

- Metal platform base available in #92 Polished Aluminum, #06 Charcoal Grey and #90 Metallic Silver.
- Refer to pages 16-20 for privacy panel options.
- Refer to page 23 for two-tone upholstery examples and yardage requirements.

SPECIFY:



1. Model number
2. Metal base finish
3. Upholstery selection
4. Options, as applicable

Modular arrangements with privacy panels, please include layout drawings or sketch with order.

ORDERING EXAMPLE:

#6110-R-TAR05-CO

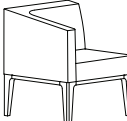
Lounge Chair, Right Arm
Corian Rotating Tablet, Right

MODEL NUMBER	PRODUCT SPECIFICATIONS	FABRIC GRADES							LEATHER GRADES				
		COM	1	2	COL			8	L1	L2	L3		
6110 	Lounge Chair, Armless W 23 D 26 ¹ / ₂ H 31 Seat Height 18 Inside Seat Width 22 ¹ / ₂ Inside Seat Depth 19 2 Yds. 42 lbs. COL 40 Sq. Ft. TB 133, add \$96 List	1351	1465	1492	1540	1589	1635	1683	1727	1776	1996	2158	2315
6110-R 	Lounge Chair, Right Arm Only (as seated) W 26 D 26 ¹ / ₂ H 31 Seat Height 18 Inside Seat Width 22 ¹ / ₂ Inside Seat Depth 19 Arm Height 29 2 ³ / ₄ Yds. 51 lbs. COL 55 Sq. Ft. TB 133, add \$132 List	1468	1624	1662	1728	1795	1858	1925	1985	2052	2355	2577	2794
6110-L 	Lounge Chair, Left Arm Only (as seated) W 26 D 26 ¹ / ₂ H 31 Seat Height 18 Inside Seat Width 22 ¹ / ₂ Inside Seat Depth 19 Arm Height 29 2 ³ / ₄ Yds. 51 lbs. COL 55 Sq. Ft. TB 133, add \$132 List	1468	1624	1662	1728	1795	1858	1925	1985	2052	2355	2577	2794

OPTIONS (XXXX - REFERS TO CHAIR MODEL NUMBER)

MODEL	DESCRIPTION	LIST
XXXX-TAR05	Veneer/Laminate Rotating Tablet, Right (as seated)	372
XXXX-TAL05	Veneer/Laminate Rotating Tablet, Left (as seated)	372
XXXX-TAR05-CO	Corian Rotating Tablet, Right (as seated)	674
XXXX-TAL05-CO	Corian Rotating Tablet, Left (as seated)	674
XXXX-NS02B	Non-Skid Glides	20
GC03 (order separately)	Ganging Brackets	75

NOTES:

- Metal platform base available in #92 Polished Aluminum, #06 Charcoal Grey and #90 Metallic Silver.
- Refer to pages 16-20 for privacy panel options.
- Refer to page 23 for two-tone upholstery examples and yardage requirements.

SPECIFY:

1. Model number
2. Metal base finish
3. Upholstery selection
4. Options, as applicable

Modular arrangements with privacy panels, please include layout drawings or sketch with order.

ORDERING EXAMPLE:

#6110-BR-NS02B

Lounge Chair, Right Side Bench
Non-Skid Glides

**DOMO
MODULAR**

designed by qdesign



SIN #711-16

MODEL NUMBER	PRODUCT SPECIFICATIONS	FABRIC GRADES							LEATHER GRADES				
		COM	1	2	COL 3	4	5	6	7	8	L1	L2	L3
6110-BR	Lounge Chair with Right Side Bench Seat (as seated) W 48 D 26 ¹ / ₂ H 31 Seat Height 18 Inside Seat Width 45 Inside Seat Depth 19 Arm Height 29 3 ¹ / ₂ Yds. 70 lbs. COL 70 Sq. Ft. TB 133, add \$168 List	1728	1927	1975	2059	2144	2225	2309	2386	2471	2857	3140	3415
6110-BL	Lounge Chair with Left Side Bench Seat (as seated) W 48 D 26 ¹ / ₂ H 31 Seat Height 18 Inside Seat Width 45 Inside Seat Depth 19 Arm Height 29 3 ¹ / ₂ Yds. 70 lbs. COL 70 Sq. Ft. TB 133, add \$168 List	1728	1927	1975	2059	2144	2225	2309	2386	2471	2857	3140	3415

OPTIONS (XXXX - REFERS TO CHAIR MODEL NUMBER)

MODEL	DESCRIPTION	LIST
XXXX-TAR05	Veneer/Laminate Rotating Tablet, Right (as seated)	372
XXXX-TAL05	Veneer/Laminate Rotating Tablet, Left (as seated)	372
XXXX-TAR05-CO	Corian Rotating Tablet, Right (as seated)	674
XXXX-TAL05-CO	Corian Rotating Tablet, Left (as seated)	674
XXXX-NS02B	Non-Skid Glides	20
GC03 (order separately)	Gangng Brackets	75

DOMO MODULAR

designed by qdesign



SIN #711-16

NOTES:

- Metal platform base available in #92 Polished Aluminum, #06 Charcoal Grey and #90 Metallic Silver.
- Refer to pages 16-20 for privacy panel options.
- Refer to page 23 for two-tone upholstery examples and yardage requirements.
- **Modular arrangements with privacy panels, please include layout drawings or sketch with order.**

SPECIFY:

1. Model number
2. Metal base finish
3. Upholstery selection
4. Options, as applicable

ORDERING EXAMPLE:

#6120-NS02B

Love Seat
Non-Skid Glides

MODEL NUMBER	PRODUCT SPECIFICATIONS	FABRIC GRADES							LEATHER GRADES				
		COM	1	2	COL			8	L1	L2	L3		
6120	Love Seat, Armless W 45 ¹ / ₂ D 26 ¹ / ₂ H 31 Seat Height 18 Inside Seat Width 45 ¹ / ₂ Inside Seat Depth 19 3 ³ / ₄ Yds. 75 lbs. COL 75 Sq. Ft. TB 133, add \$180 List	1904	2117	2168	2259	2349	2436	2527	2609	2700	3113	3416	3712
6120-R	Love Seat, Right Arm Only (as seated) W 48 ¹ / ₄ D 26 ¹ / ₂ H 31 Seat Height 18 Inside Seat Width 45 Inside Seat Depth 19 Arm Height 29 4 ¹ / ₄ Yds. 84 lbs. COL 85 Sq. Ft. TB 133, add \$204 List	2021	2262	2320	2423	2526	2624	2727	2820	2923	3391	3735	4070
6120-L	Love Seat, Left Arm Only (as seated) W 48 ¹ / ₄ D 26 ¹ / ₂ H 31 Seat Height 18 Inside Seat Width 45 Inside Seat Depth 19 Arm Height 29 4 ¹ / ₄ Yds. 84 lbs. COL 85 Sq. Ft. TB 133, add \$204 List	2021	2262	2320	2423	2526	2624	2727	2820	2923	3391	3735	4070

OPTIONS (XXXX - REFERS TO CHAIR MODEL NUMBER)

MODEL	DESCRIPTION	LIST
XXXX-TAR05	Veneer/Laminate Rotating Tablet, Right (as seated)	372
XXXX-TAL05	Veneer/Laminate Rotating Tablet, Left (as seated)	372
XXXX-TAR05-CO	Corian Rotating Tablet, Right (as seated)	674
XXXX-TAL05-CO	Corian Rotating Tablet, Left (as seated)	674
XXXX-NS02B	Non-Skid Glides	20
GC03 (order separately)	Ganging Brackets	75

NOTES:

- Metal platform base available in #92 Polished Aluminum, #06 Charcoal Grey and #90 Metallic Silver.
- Refer to pages 16-20 for privacy panel options.
- Refer to page 23 for two-tone upholstery examples and yardage requirements.
- **Modular arrangements with privacy panels, please include layout drawings or sketch with order.**

SPECIFY:

1. Model number
2. Metal base finish
3. Upholstery selection
4. Options, as applicable

ORDERING EXAMPLE:

#6120-BR-NS02B



Love Seat, Right Side Bench
Non-Skid Glides

**DOMO
MODULAR**

designed by qdesign



SIN #711-16

MODEL NUMBER	PRODUCT SPECIFICATIONS	FABRIC GRADES							LEATHER GRADES				
		COM	1	2	COL 3	4	5	6	7	8	L1	L2	L3
6120-BR	 <p>Love Seat with Right Side Bench Seat (as seated) W 71 D 26¹/₂ H 31 Seat Height 18 Inside Seat Width 67 Inside Seat Depth 19 Arm Height 29 5¹/₄ Yds. 105 lbs. COL 105 Sq. Ft. TB 133, add \$252 List</p>	2280	2578	2650	2777	2903	3025	3151	3267	3394	3973	4397	4811
6120-BL	 <p>Love Seat with Left Side Bench Seat (as seated) W 71 D 26¹/₂ H 31 Seat Height 18 Inside Seat Width 67 Inside Seat Depth 19 Arm Height 29 5¹/₄ Yds. 105 lbs. COL 105 Sq. Ft. TB 133, add \$252 List</p>	2280	2578	2650	2777	2903	3025	3151	3267	3394	3973	4397	4811

OPTIONS (XXXX - REFERS TO CHAIR MODEL NUMBER)

MODEL	DESCRIPTION	LIST
XXXX-TAR05	Veneer/Laminate Rotating Tablet, Right (as seated)	372
XXXX-TAL05	Veneer/Laminate Rotating Tablet, Left (as seated)	372
XXXX-TAR05-CO	Corian Rotating Tablet, Right (as seated)	674
XXXX-TAL05-CO	Corian Rotating Tablet, Left (as seated)	674
XXXX-NS02B	Non-Skid Glides	20
GC03 (order separately)	Ganging Brackets	75

DOMO MODULAR

designed by qdesign



SIN #711-16

NOTES:

- Metal platform base available in #92 Polished Aluminum, #06 Charcoal Grey and #90 Metallic Silver.
- Refer to pages 16-20 for privacy panel options.
- Refer to page 23 for two-tone upholstery examples and yardage requirements.
- **Modular arrangements with privacy panels, please include layout drawings or sketch with order.**

SPECIFY:

1. Model number
2. Metal base finish
3. Upholstery selection
4. Options, as applicable

ORDERING EXAMPLE:

#6130-NS02B

Sofa
Non-Skid Glides

MODEL NUMBER	PRODUCT SPECIFICATIONS	FABRIC GRADES							LEATHER GRADES				
		COM	1	2	COL			8	L1	L2	L3		
6130	Sofa, Armless W 67 ¹ / ₂ D 26 ¹ / ₂ H 31 Seat Height 18 Inside Seat Width 67 ¹ / ₂ Inside Seat Depth 19 5 ¹ / ₄ Yds. 102 lbs. COL 105 Sq. Ft. TB 133, add \$252 List	2523	2821	2893	3020	3146	3268	3394	3510	3637	4216	4640	5054
6130-R	Sofa, Right Arm Only (as seated) W 71 D 26 ¹ / ₂ H 31 Seat Height 18 Inside Seat Width 67 Inside Seat Depth 19 Arm Height 29 5 ³ / ₄ Yds. 116 lbs. COL 115 Sq. Ft. TB 133, add \$276 List	2639	2966	3044	3183	3322	3455	3593	3720	3859	4493	4958	5411
6130-L	Sofa, Left Arm Only (as seated) W 71 D 26 ¹ / ₂ H 31 Seat Height 18 Inside Seat Width 67 Inside Seat Depth 19 Arm Height 29 5 ³ / ₄ Yds. 116 lbs. COL 115 Sq. Ft. TB 133, add \$276 List	2639	2966	3044	3183	3322	3455	3593	3720	3859	4493	4958	5411

OPTIONS (XXXX - REFERS TO CHAIR MODEL NUMBER)

MODEL	DESCRIPTION	LIST
XXXX-TAR05	Veneer/Laminate Rotating Tablet, Right (as seated)	372
XXXX-TAL05	Veneer/Laminate Rotating Tablet, Left (as seated)	372
XXXX-TAR05-CO	Corian Rotating Tablet, Right (as seated)	674
XXXX-TAL05-CO	Corian Rotating Tablet, Left (as seated)	674
XXXX-NS02B	Non-Skid Glides	20
GC03 (order separately)	Ganging Brackets	75

NOTES:

- Metal platform base available in #92 Polished Aluminum, #06 Charcoal Grey and #90 Metallic Silver.
- Refer to pages 16-20 for privacy panel options.
- Refer to page 23 for two-tone upholstery examples and yardage requirements.
- **Modular arrangements with privacy panels, please include layout drawings or sketch with order.**

SPECIFY:

1. Model number
2. Metal base finish
3. Upholstery selection
4. Options, as applicable

ORDERING EXAMPLE:

#6140-NS02B



90-Degree Corner Lounge
Non-Skid Glides

**DOMO
MODULAR**

designed by qdesign

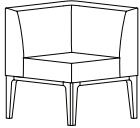

SIN #711-16

MODEL NUMBER	PRODUCT SPECIFICATIONS	FABRIC GRADES								LEATHER GRADES			
		COM	1	2	COL			7	8	L1	L2	L3	
6140	 <p>90-Degree Corner Lounge Unit W 26¹/₂ D 26¹/₂ H 31 Seat Height 18 Inside Seat Width 19 Inside Seat Depth 19 Arm Height 29 2³/₄ Yds. 51 lbs. COL 55 Sq. Ft. TB 133, add \$132 List</p>	1529	1685	1723	1789	1856	1919	1986	2046	2113	2416	2638	2855
6145	 <p>120-Degree Corner Lounge Unit W 46 D 37 H 31 Seat Height 18 Inside Seat Width 46 Inside Seat Depth 37 3¹/₄ Yds. 67 lbs. COL 65 Sq. Ft. TB 133, add \$156 List</p>	1821	2006	2050	2129	2207	2282	2361	2432	2511	2869	3132	3388

OPTIONS (XXXX - REFERS TO CHAIR MODEL NUMBER)

MODEL	DESCRIPTION	LIST
XXXX-NS02B	Non-Skid Glides, 90-Degree Corner Unit	20
XXXX-NS02C	Non-Skid Glides, 120-Degree Corner Unit	25
GC03 (order separately)	Gangng Brackets	75

DOMO MODULAR

designed by qdesign



SIN #711-16

NOTES:

- Mobile ottoman features two locking casters in rear and two non-locking casters in front. Casters available with chrome detail only.
- Casters feature semi-soft treads for compatibility on all floor surfaces.
- Ottoman swivel base standard with auto-return feature.
- Swivel base available in Polished Stainless Steel only.
- Maximum weight capacity is 350 lbs.
- Refer to page 24 for two-tone upholstery examples and yardage requirements.

SPECIFY:

1. Model number
2. Upholstery selection

ORDERING EXAMPLE:

#6150-S
Ottoman, Swivel Base

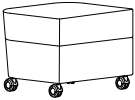
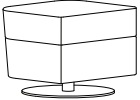
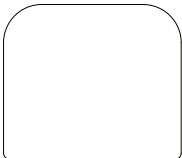
MODEL NUMBER	PRODUCT SPECIFICATIONS	FABRIC GRADES							LEATHER GRADES				
		COM	1	2	COL 3	4	5	6	7	8	L1	L2	L3
6150-C 	Ottoman, Casters W 21 D 24 H 18 2 Yds. 30 lbs. COL 40 Sq. Ft. TB 133, add \$96 List	1113	1227	1254	1302	1351	1397	1445	1489	1538	1758	1920	2077
6150-S 	Ottoman, Swivel Base, Auto-Return W 21 D 24 H 18 2 Yds. 72 lbs. COL 40 Sq. Ft. TB 133, add \$96List	1290	1404	1431	1479	1528	1574	1622	1666	1715	1935	2097	2254
Top View 													

NOTES:

- Available individually or in modular combinations with connecting tables and lounge seating units.
- Asymmetrical pentagon bench features five sides and seats up to four.
- Metal platform base available in #92 Polished Aluminum, #06 Charcoal Grey and #90 Metallic Silver.
- Maximum weight capacity is 350 lbs. per seat position.

SPECIFY:

1. Model number
2. Metal base finish
3. Upholstery selection
4. Options, as applicable

Modular arrangements with privacy panels, please include layout drawings or sketch with order.

ORDERING EXAMPLE:

#6163-NS02B

3-Seat Bench
Non-Skid Glides

**DOMO
MODULAR**

designed by qdesign

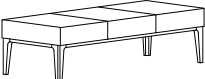
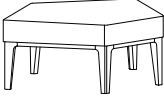

SIN #711-16

MODEL NUMBER	PRODUCT SPECIFICATIONS	FABRIC GRADES							LEATHER GRADES				
		COM	1	2	COL 3	4	5	6	7	8	L1	L2	L3
6162 	2-Seat Bench W 44 ¹ / ₂ D 27 H 18 2 Yds. 50 lbs. COL 40 Sq. Ft. TB 133, add \$96 List	1469	1583	1610	1658	1707	1753	1801	1845	1894	2114	2276	2433
6163 	3-Seat Bench W 67 ¹ / ₄ D 27 H 18 2 ³ / ₄ Yds. 70 lbs. COL 55 Sq. Ft. TB 133, add \$132 List	1753	1909	1947	2013	2080	2143	2210	2270	2337	2640	2862	3079
6164 	120-Degree Pentagonal Bench See Dimensions Below Seat Height 18 2 ¹ / ₄ Yds. 47 lbs. COL 45 Sq. Ft. TB 133, add \$108 List	1634	1762	1793	1847	1901	1953	2008	2057	2112	2360	2542	2719

Top View

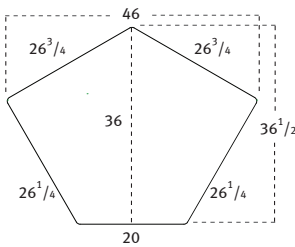

OPTIONS (XXXX - REFERS TO BENCH MODEL NUMBER)

MODEL	DESCRIPTION	LIST
XXXX-NS02B	Non-Skid Glides, 2 and 3-Seat Benches	20
XXXX-NS02C	Non-Skid Glides, 120-Degree Pentagonal Bench	25
GC03 (order separately)	Ganging Brackets	75

DOMO MODULAR

designed by qdesign



SIN #711-16

NOTES:

- Asymmetrical pentagonal table features five sides and is available individually or in modular combinations with lounge and bench seating units.
- 3" table thickness.
- Available in Maple, Walnut and White Oak veneer as well as laminate and Corian.
- **Table with Corian top, wood edge species and finish selection must be specified.**
- Metal platform base available in #92 Polished Aluminum, #06 Charcoal Grey and #90 Metallic Silver.

SPECIFY:

1. Model number
 2. Table wood species
 3. Table top finish
 4. Edge finish, as applicable
 5. Metal base finish
 6. Tablet finish, as applicable
 7. Options, as applicable
- Modular arrangements with privacy panels, please include layout drawings or sketch with order.**

ORDERING EXAMPLE:

#6174-TAR18-CO-NS02C
 Pentagon Table with Right Side Tablet, Corian Top Finish
 Corian Tablet
 Non-Skid Glides

MODEL NUMBER	PRODUCT SPECIFICATIONS	TABLE TOP FINISH	
		VENEER OR LAMINATE	CORIAN (-CO)
6174	<p>120-Degree Pentagonal Table See Dimensions Table Height 15 56 lbs.</p>	1780	4269

OPTIONS (XXXX - REFERS TO TABLE MODEL NUMBER)

MODEL	DESCRIPTION	LIST	
XXXX-TAR18	Veneer/Laminate Rotating Table, Right (narrow side, as seated)	326	 right side, as seated
XXXX-TAL18	Veneer/Laminate Rotating Table, Left (narrow side, as seated)	326	
XXXX-TAR18-CO	Corian Rotating Table, Right (narrow side, as seated)	629	 right side, as seated
XXXX-TAL18-CO	Corian Rotating Table, Left (narrow side, as seated)	629	
XXXX-TAY18	Veneer/Laminate Rotating Table, Right (wider side, as seated)	326	 left side, as seated
XXXX-TAZ18	Veneer/Laminate Rotating Table, Left (wider side, as seated)	326	
XXXX-TAY18-CO	Corian Rotating Table, Right (wider side, as seated)	629	 left side, as seated
XXXX-TAZ18-CO	Corian Rotating Table, Left (wider side, as seated)	629	
XXXX-PB1-S	Power Band 1 (one power, two USB), Silver	413	<p>WIDER SIDE</p> right side, as seated left side, as seated
XXXX-PB1-W	Power Band 1 (one power, two USB), White	413	
XXXX-PB2-S	Power Band 2 (dual power), Silver	322	
XXXX-PB2-W	Power Band 2 (dual power), White	322	
XXXX-PB3-S	Power Band 3 (dual power, two USB), Silver	429	
XXXX-PB3-W	Power Band 3 (dual power, two USB), White	429	
XXXX-NS02C	Non-Skid Glides	25	
GC03 (order separately)	Ganging Brackets	75	

NOTES:

- Connecting tables available as corner, in-line and end options.
- 3" table thickness.
- Available in Maple, Walnut and White Oak veneer as well as laminate and Corian.
- **Table with Corian top, wood edge species and finish selection must be specified.**
- Metal platform base available in #92 Polished Aluminum, #06 Charcoal Grey and #90 Metallic Silver.
- **Mounting hardware included.**

SPECIFY:

1. Model number
2. Table wood species
3. Table top finish
4. Edge finish, as applicable
5. Metal base finish, as applicable
6. Tablet finish, as applicable
7. Options, as applicable

Modular arrangements with privacy panels, please include layout drawings or sketch with order.

ORDERING EXAMPLE:

#6180-CO-NS02D



90-Degree Corner Table
Corian Top
Non-Skid Glides

**DOMO
MODULAR**

designed by qdesign

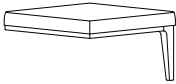

SIN #711-16

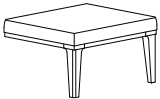
MODEL NUMBER	PRODUCT SPECIFICATIONS	TABLE TOP FINISH	
		VENEER OR LAMINATE	CORIAN (-CO)
6180 	90-Degree Corner Table W 26 ¹ / ₄ D 26 ¹ / ₄ H 15 34 lbs.	1295	1988
6185 	In-Line Table W 22 ¹ / ₂ D 26 ¹ / ₄ H 31 28 lbs.	1143	1836
6185-ET 	End Table W 22 ¹ / ₂ D 26 H 15 31 lbs.	1283	1976

OPTIONS (XXXX - REFERS TO TABLE MODEL NUMBER)

MODEL	DESCRIPTION	LIST
XXXX-TAR18	Veneer/Laminate Rotating Table, Right (narrow side, as seated)	326
XXXX-TAL18	Veneer/Laminate Rotating Table, Left (narrow side, as seated)	326
XXXX-TAR18-CO	Corian Rotating Table, Right (narrow side, as seated)	629
XXXX-TAL18-CO	Corian Rotating Table, Left (narrow side, as seated)	629
XXXX-PB1-S	Power Band 1 (one power, two USB), Silver	413
XXXX-PB1-W	Power Band 1 (one power, two USB), White	413
XXXX-PB2-S	Power Band 2 (dual power), Silver	322
XXXX-PB2-W	Power Band 2 (dual power), White	322
XXXX-PB3-S	Power Band 3 (dual power, two USB), Silver	429
XXXX-PB3-W	Power Band 3 (dual power, two USB), White	429
XXXX-NS02D	Non-Skid Glides, 90-Degree Corner Table	5
XXXX-NS02A	Non-Skid Glides, End Table	10
GC03 (order separately)	Ganging Brackets	75

DOMO MODULAR

designed by qdesign



PRIVACY PANELS ORDERING INFORMATION:

- Determine overall seating/table span (2, 3 or 4) , taking into consideration if models are armless, with one arm or two arms.
- Inline, corner and end tables counted as one span.
- **IMPORTANT: Please note that the 90-degree lounge unit (model #6140), 90-degree corner table (model #6180) and 120-degree corner pentagonal units (models #6140, #6164 and #6174) must be counted as one seat AND one arm, per side.**
- **Note: Layout drawings or sketch must be provided with panel order.**

SPECIFY:

1. Model number
2. Panel finish

ORDERING EXAMPLE:

#HS-3AA-W
Semi-Private Back Panel
3-Seat Span with Two Arms
Whiteboard Material

SIN #711-16

PANEL HEIGHTS:

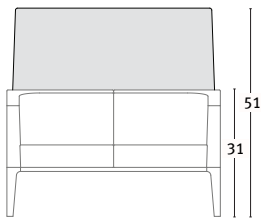

FS = Private Panel (high)

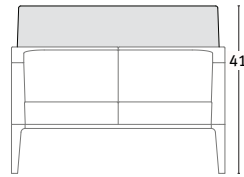

HS = Semi-Private Panel (low)

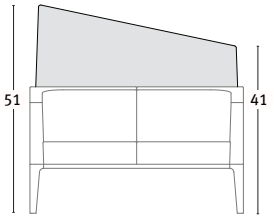

TSL = Transitional Panel (high to low)

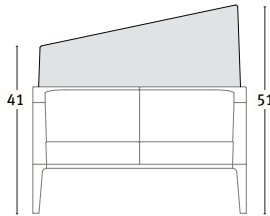

TSR = Transitional Panel (low to high)

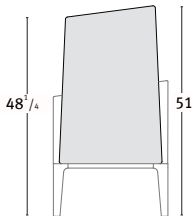

AFR/AFL = Private Arm Panel (high)

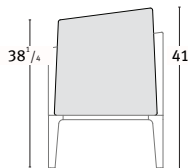

AHR/AHL = Semi-Private Arm Panel (low)

PRIVACY PANEL ORDERING EXAMPLES:

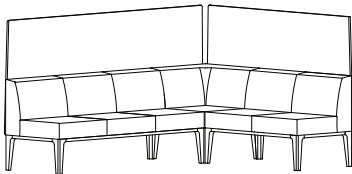

Qty	Model #	Description	COM List
1	FS-4A-U	Private Back Panel, 4-Seat Span, 1 Arm*, Upholstered	992
1	FS-3A-U	Private Back Panel, 3-Seat Span, 1 Arm*, Upholstered	851

* Due to the 90-degree lounge unit.

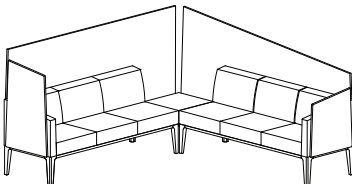

Qty	Model #	Description	List
1	AFR-V	Private Arm Panel, Right (as seated), Veneer Finish	646
1	FS-4AA-V	Private Back Panel, 4-Seat Span, Two Arms*, Veneer Finish	1,692
1	TSL-4AA-V	Transitional Back Panel, 4-Seat Span, Two Arms*, Veneer Finish	1,692
1	AHL-V	Semi-Private Arm Panel, Left (as seated), Veneer Finish	540

* Due to the corner table unit.

PANEL WIDTHS*:

Model	Top	Bottom
2-Seat Span, No Arms	40 ¹ / ₂	42 ¹ / ₂
2-Seat Span, One Arm	44 ¹ / ₂	46 ¹ / ₂
2-Seat Span, Two Arms	47 ³ / ₄	49 ³ / ₄
3-Seat Span, No Arms	63 ¹ / ₄	65 ¹ / ₄
3-Seat Span, One Arm	67 ¹ / ₄	69 ¹ / ₄
3-Seat Span, Two Arms	71 ³ / ₄	73 ³ / ₄
4-Seat Span, No Arms	85 ¹ / ₂	87 ¹ / ₂
4-Seat Span, One Arm	89 ¹ / ₂	89 ¹ / ₂
4-Seat Span, Two Arms	93 ¹ / ₂	95 ¹ / ₂
Arm Panel	22	24 ¹ / ₂

*Dimensions are nominal and vary slightly between panel styles.

Refer to page 22 for additional examples.

NOTES:

- Veneer panels available in Maple, Walnut and White Oak wood species.
- Panels ordered separately from seating units and cannot be retrofitted to previously ordered seating unit.
- Field-installation required.
- **IMPORTANT:** Please note that the 90-degree lounge unit (model #6140), 90-degree corner table (model #6180) and 120-degree corner pentagonal units (models #6140, #6164 and #6174) must be counted as one seat AND one arm, per side.
- **Note:** Layout drawings or sketch must be provided with panel order.

SPECIFY:

1. Model number
2. Panel finish

ORDERING EXAMPLE:

#FS-2AA-L
2-Seat Span with Two Arms
Laminate Finish

**DOMO
MODULAR**

designed by qdesign



SIN #711-16

DESCRIPTION	MODEL NUMBER	VENEER (-V)	LAMINATE (-L)	WHITEBOARD (-W)	WEIGHT
PRIVATE BACK PANEL (51" HIGH)					
2-SEAT SPAN, NO ARMS	FS-2(-)	1079	1079	1187	20
2-SEAT SPAN WITH ONE ARM	FS-2A(-)	1090	1090	1199	20
2-SEAT SPAN WITH TWO ARMS	FS-2AA(-)	1103	1103	1213	20
3-SEAT SPAN, NO ARMS	FS-3(-)	1400	1400	1540	28
3-SEAT SPAN WITH ONE ARM	FS-3A(-)	1412	1412	1551	28
3-SEAT SPAN WITH TWO ARMS	FS-3AA(-)	1423	1423	1565	28
4-SEAT SPAN, NO ARMS	FS-4(-)	1669	1669	1835	35
4-SEAT SPAN WITH ONE ARM	FS-4A(-)	1680	1680	1848	35
4-SEAT SPAN WITH TWO ARMS	FS-4AA(-)	1692	1692	1861	35
TRANSITIONAL BACK PANEL (51" LEFT TO 41" RIGHT, AS SEATED)					
2-SEAT SPAN, NO ARMS	TSL-2(-)	1079	1079	1187	18
2-SEAT SPAN WITH ONE ARM	TSL-2A(-)	1090	1090	1199	18
2-SEAT SPAN WITH TWO ARMS	TSL-2AA(-)	1103	1103	1213	18
3-SEAT SPAN, NO ARMS	TSL-3(-)	1400	1400	1540	26
3-SEAT SPAN WITH ONE ARM	TSL-3A(-)	1412	1412	1551	26
3-SEAT SPAN WITH TWO ARMS	TSL-3AA(-)	1423	1423	1565	26
4-SEAT SPAN, NO ARMS	TSL-4(-)	1669	1669	1835	33
4-SEAT SPAN WITH ONE ARM	TSL-4A(-)	1680	1680	1848	33
4-SEAT SPAN WITH TWO ARMS	TSL-4AA(-)	1692	1692	1861	33
TRANSITIONAL BACK PANEL (41" LEFT TO 51" RIGHT, AS SEATED)					
2-SEAT SPAN, NO ARMS	TSR-2(-)	1079	1079	1187	18
2-SEAT SPAN WITH ONE ARM	TSR-2A(-)	1090	1090	1199	18
2-SEAT SPAN WITH TWO ARMS	TSR-2AA(-)	1103	1103	1213	18
3-SEAT SPAN, NO ARMS	TSR-3(-)	1400	1400	1540	26
3-SEAT SPAN WITH ONE ARM	TSR-3A(-)	1412	1412	1551	26
3-SEAT SPAN WITH TWO ARMS	TSR-3AA(-)	1423	1423	1565	26
4-SEAT SPAN, NO ARMS	TSR-4(-)	1669	1669	1835	33
4-SEAT SPAN WITH ONE ARM	TSR-4A(-)	1680	1680	1848	33
4-SEAT SPAN WITH TWO ARMS	TSR-4AA(-)	1692	1692	1861	33

DOMO MODULAR

designed by qdesign



NOTES:

- Veneer panels available in Maple, Walnut and White Oak wood species.
- Panels ordered separately from seating units and cannot be retrofit to previously ordered seating unit.
- Field-installation required.
- **IMPORTANT: Please note that the 90-degree lounge unit (model #6140), 90-degree corner table (model #6180) and 120-degree corner pentagonal units (models #6140, #6164 and #6174) must be counted as one seat AND one arm, per side.**
- **Note: Layout drawings or sketch must be provided with panel order.**

SPECIFY:

1. Model number
2. Panel finish

ORDERING EXAMPLE:

#HS-4A-W
4-Seat Span, One Arm
Whiteboard Finish

SIN #711-16

DESCRIPTION	MODEL NUMBER	VENEER (-V)	LAMINATE (-L)	WHITEBOARD (-W)	WEIGHT
SEMI-PRIVATE BACK PANEL (41" HIGH)					
2-SEAT SPAN, NO ARMS	HS-2(-)	989	989	1085	13
2-SEAT SPAN WITH ONE ARM	HS-2A(-)	999	999	1100	13
2-SEAT SPAN WITH TWO ARMS	HS-2AA(-)	1,010	1010	1111	13
3-SEAT SPAN, NO ARMS	HS-3(-)	1280	1280	1409	19
3-SEAT SPAN WITH ONE ARM	HS-3A(-)	1293	1293	1420	19
3-SEAT SPAN WITH TWO ARMS	HS-3AA(-)	1304	1304	1434	19
4-SEAT SPAN, NO ARMS	HS-4(-)	1520	1520	1672	27
4-SEAT SPAN WITH ONE ARM	HS-4A(-)	1532	1532	1685	27
4-SEAT SPAN WITH TWO ARMS	HS-4AA(-)	1544	1544	1698	27
PRIVATE ARM PANEL (51" HIGH)					
RIGHT, AS SEATED	AFR(-)	646	646	710	9
LEFT, AS SEATED	AFL(-)	646	646	710	9
SEMI-PRIVATE ARM PANEL (41" HIGH)					
RIGHT, AS SEATED	AHR(-)	540	540	595	7
LEFT, AS SEATED	AHL(-)	540	540	595	7

NOTES:

- Upholstered panels available in fabric, vinyl or faux leather.
- Panels ordered separately from seating units and cannot be retrofit to previously ordered seating unit.
- Field-installation required.
- **IMPORTANT: Please note that the 90-degree lounge unit (model #6140), 90-degree corner table (model #6180) and 120-degree corner pentagonal units (models #6140, #6164 and #6174) must be counted as one seat AND one arm, per side.**
- **Note: Layout drawings or sketch must be provided with panel order.**

SPECIFY:

1. Model number
2. Panel fabric selection

ORDERING EXAMPLE:

#TSL-3-U
3-Seat Span, No Arms
Upholstered Panel

**DOMO
MODULAR**

designed by qdesign



SIN #711-16

UPHOLSTERY PANELS

FABRIC GRADES

DESCRIPTION	YARDS	MODEL NUMBER	COM	COL								WEIGHT
				1	2	3	4	5	6	7	8	
PRIVATE BACK PANEL (51" HIGH)												
2-SEAT SPAN, NO ARMS	2 ³ / ₄	FS-2-U	704	860	898	964	1031	1094	1161	1221	1288	23
2-SEAT SPAN WITH ONE ARM	2 ³ / ₄	FS-2A-U	710	866	904	970	1037	1100	1167	1227	1294	23
2-SEAT SPAN WITH TWO ARMS	4 ³ / ₄	FS-2AA-U	718	988	1053	1167	1282	1392	1507	1611	1726	23
3-SEAT SPAN, NO ARMS	4	FS-3-U	845	1072	1127	1223	1320	1412	1509	1597	1694	32
3-SEAT SPAN WITH ONE ARM	4 ¹ / ₄	FS-3A-U	851	1092	1150	1253	1356	1454	1557	1650	1753	32
3-SEAT SPAN WITH TWO ARMS	4 ³ / ₄	FS-3AA-U	856	1126	1191	1305	1420	1530	1645	1749	1864	32
4-SEAT SPAN, NO ARMS	5 ¹ / ₂	FS-4-U	986	1298	1373	1506	1639	1766	1899	2020	2153	40
4-SEAT SPAN WITH ONE ARM	5 ¹ / ₂	FS-4A-U	992	1304	1379	1512	1645	1772	1905	2026	2159	40
4-SEAT SPAN WITH TWO ARMS	6	FS-4AA-U	997	1338	1420	1564	1709	1848	1993	2125	2270	40
TRANSITIONAL BACK PANEL (51" LEFT TO 41" RIGHT, AS SEATED)												
2-SEAT SPAN, NO ARMS	2 ³ / ₄	TSL-2-U	704	860	898	964	1031	1094	1161	1221	1288	21
2-SEAT SPAN WITH ONE ARM	3	TSL-2A-U	710	881	922	994	1066	1136	1208	1274	1347	21
2-SEAT SPAN WITH TWO ARMS	4 ¹ / ₄	TSL-2AA-U	718	959	1017	1120	1223	1321	1424	1517	1620	21
3-SEAT SPAN, NO ARMS	4	TSL-3-U	845	1072	1127	1223	1320	1412	1509	1597	1694	30
3-SEAT SPAN WITH ONE ARM	4 ¹ / ₄	TSL-3A-U	851	1092	1150	1253	1356	1454	1557	1650	1753	30
3-SEAT SPAN WITH TWO ARMS	4 ¹ / ₂	TSL-3AA-U	856	1112	1173	1282	1390	1494	1603	1702	1811	30
4-SEAT SPAN, NO ARMS	5 ¹ / ₂	TSL-4-U	986	1298	1373	1506	1639	1766	1899	2020	2153	38
4-SEAT SPAN WITH ONE ARM	5 ¹ / ₂	TSL-4A-U	992	1304	1379	1512	1645	1772	1905	2026	2159	38
4-SEAT SPAN WITH TWO ARMS	5 ¹ / ₂	TSL-4AA-U	997	1309	1384	1517	1650	1777	1910	2031	2164	38
TRANSITIONAL BACK PANEL (41" LEFT TO 51" RIGHT, AS SEATED)												
2-SEAT SPAN, NO ARMS	2 ³ / ₄	TSR-2-U	704	860	898	964	1031	1094	1161	1221	1288	21
2-SEAT SPAN WITH ONE ARM	3	TSR-2A-U	710	881	922	994	1066	1136	1208	1274	1347	21
2-SEAT SPAN WITH TWO ARMS	4 ¹ / ₄	TSR-2AA-U	718	959	1017	1120	1223	1321	1424	1517	1620	21
3-SEAT SPAN, NO ARMS	4	TSR-3-U	845	1072	1127	1223	1320	1412	1509	1597	1694	30
3-SEAT SPAN WITH ONE ARM	4 ¹ / ₄	TSR-3A-U	851	1092	1150	1253	1356	1454	1557	1650	1753	30
3-SEAT SPAN WITH TWO ARMS	4 ¹ / ₂	TSR-3AA-U	856	1112	1173	1282	1390	1494	1603	1702	1811	30
4-SEAT SPAN, NO ARMS	5 ¹ / ₂	TSR-4-U	986	1298	1373	1506	1639	1766	1899	2020	2153	38
4-SEAT SPAN WITH ONE ARM	5 ¹ / ₂	TSR-4A-U	992	1304	1379	1512	1645	1772	1905	2026	2159	38
4-SEAT SPAN WITH TWO ARMS	5 ¹ / ₂	TSR-4AA-U	997	1309	1384	1517	1650	1777	1910	2031	2164	38

DOMO MODULAR

designed by qdesign



NOTES:

- Upholstered panels available in fabric, vinyl or faux leather.
- Panels ordered separately from seating units and cannot be retrofit to previously ordered seating unit.
- Field-installation required.
- **IMPORTANT: Please note that the 90-degree lounge unit (model #6140), 90-degree corner table (model #6180) and 120-degree corner pentagonal units (models #6140, #6164 and #6174) must be counted as one seat AND one arm, per side.**
- **Note: Layout drawings or sketch must be provided with panel order.**

SPECIFY:

1. Model number
2. Panel fabric selection

ORDERING EXAMPLE:

#AFR-U
Private Arm Panel, Right Upholstered Panel

SIN #711-16

UPHOLSTERY PANELS				FABRIC GRADES								
DESCRIPTION	YARDS	MODEL NUMBER	COM	1	2	COL 3	4	5	6	7	8	WEIGHT
SEMI-PRIVATE BACK PANEL (41" HIGH)												
2-SEAT SPAN, NO ARMS	2 ³ / ₄	HS-2-U	648	804	842	908	975	1038	1105	1165	1232	15
2-SEAT SPAN WITH ONE ARM	3	HS-2A-U	654	825	866	938	1010	1080	1152	1218	1291	15
2-SEAT SPAN WITH TWO ARMS	3 ¹ / ₄	HS-2AA-U	660	845	889	968	1046	1121	1200	1271	1350	15
3-SEAT SPAN, NO ARMS	4	HS-3-U	776	1003	1058	1154	1251	1343	1440	1528	1625	22
3-SEAT SPAN WITH ONE ARM	4 ¹ / ₄	HS-3A-U	783	1024	1082	1185	1288	1386	1489	1582	1685	22
3-SEAT SPAN WITH TWO ARMS	4 ¹ / ₂	HS-3AA-U	788	1044	1105	1214	1322	1426	1535	1634	1743	22
4-SEAT SPAN, NO ARMS	5 ¹ / ₂	HS-4-U	907	1219	1294	1427	1560	1687	1820	1941	2074	31
4-SEAT SPAN WITH ONE ARM	5 ¹ / ₂	HS-4A-U	913	1225	1300	1433	1566	1693	1826	1947	2080	31
4-SEAT SPAN WITH TWO ARMS	5 ³ / ₄	HS-4AA-U	918	1245	1323	1462	1601	1734	1872	1999	2138	31
PRIVATE ARM PANEL (51" HIGH)												
RIGHT, AS SEATED	1 ¹ / ₂	AFR-U	488	574	594	630	666	701	737	770	807	12
LEFT, AS SEATED	1 ¹ / ₂	AFL-U	488	574	594	630	666	701	737	770	807	12
SEMI-PRIVATE ARM PANEL (41" HIGH)												
RIGHT, AS SEATED	1 ¹ / ₂	AHR-U	488	574	594	630	666	701	737	770	807	9
LEFT, AS SEATED	1 ¹ / ₂	AHL-U	488	574	594	630	666	701	737	770	807	9

NOTES:

- Pull-up table available in Maple, Walnut and White Oak veneer, as well as laminate and Corian.
- For maximum durability, a Corian tablet or laminate surface with a clear coat edge finish is recommended.
- Refer to page 3 for edge specifications.
- Table column will match base plate as standard, unless otherwise specified. For Stainless Steel Clad base plate, column will be #91 Chrome.

SPECIFY:

1. Model number
2. Wood species
3. Wood finish
4. Edge finish, as applicable
5. Base finish

ORDERING EXAMPLE:

#6191-CO
 Pull-Up Table
 Corian Top

**DOMO
 MODULAR**

designed by qdesign



SIN #711-16

MODEL NUMBER	PRODUCT SPECIFICATIONS	TABLE TOP FINISH	
		VENEER OR LAMINATE	CORIAN (-CO)
<p>6191</p> 	<p>Offset Pull-Up Table Overall Dimensions: 18" W x 14" D x 27" H 3/4" Table Top Thickness Base Plate Dimensions: 14" W x 14" L x 1/2" thick Square Column Dimensions: 2 3/8" x 2 3/8" Metal Tube 25 lbs.</p>	851	1088

Corian Top Colors:

- Designer White
- Linen
- Rain Cloud
- Witch Hazel

Base Finish Colors:

- Stainless Steel Clad (base plate only)
- #91 Chrome (table column only)
- #06 Charcoal Grey
- #90 Metallic Silver

DOMO MODULAR

designed by qdesign



SIN #711-16

CONFIGURATION AND ORDERING EXAMPLES

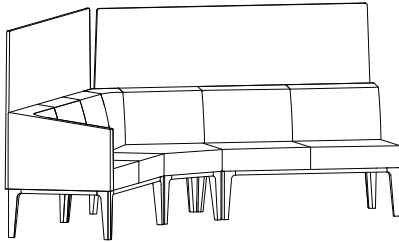

Qty	Model #	Description	COM List
1	6130-R	Sofa, Right Arm (as seated)	2,639
1	6145	120-Degree Corner Lounge Unit	1,821
1	6120	Love Seat, Armless	1,904
1	FS-4AA-W	Private Back Panel, 4-Seat Span, Two Arms, Whiteboard	1,848
1	FS-3A-W	Private Back Panel, 3-Seat Span, One Arm, Whiteboard	1,551
5			9,763

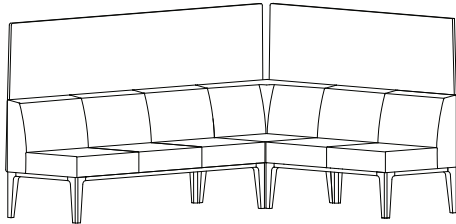

Qty	Model #	Description	COM List
1	6130	Sofa, Armless	2,523
1	6140	90-Degree Corner Lounge Unit	1,529
1	6120	Love Seat, Armless	1,904
1	FS-4A-U	Private Back Panel, 4-Seat Span, 1 Arm*, Upholstered	992
1	FS-3A-U	Private Back Panel, 3-Seat Span, 1 Arm*, Upholstered	851
5			7,799

* Due to the 90-degree corner lounge unit.

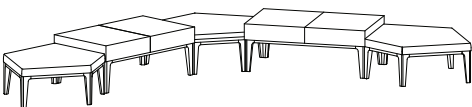

Qty	Model #	Description	COM List
3	6174-V	120-Degree Pentagon Table, Veneer Finish (\$1,780 each)	5,340
2	6162	2-Seat Bench (\$1,469 each)	2,938
5			8,278

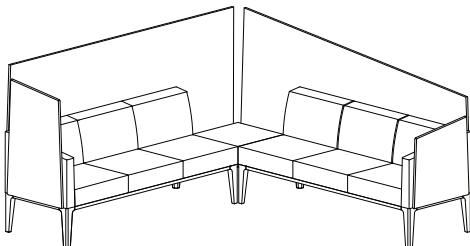

Qty	Model #	Description	COM List
1	6130-R	Sofa, Right Arm (as seated)	2,639
1	6180-V	90-Degree Corner Table, Veneer Finish	1,295
1	6130-L	Sofa, Left Arm (as seated)	2,639
1	AFR-V	Private Arm Panel, Right Arm (as seated), Veneer Finish	646
1	FS-4AA-V	Private Back Panel, 4-Seat Span, Two Arms*, Veneer Finish	1,692
1	TSL-4AA-V	Transitional Back Panel, 4-Seat Span, Two Arms*, Veneer Finish	1,692
1	AHL-V	Semi-Private Arm Panel, Left Arm (as seated), Veneer Finish	540
7			11,143

* Due to the corner table unit.

Note: Domo ganging connectors not included in pricing examples as shown above.

UPHOLSTERY COMBINATIONS:

For fabric, vinyl or leather upholstery combinations, refer to the pricing below:

- When combining **two** COM/COV/COL fabrics, or fabrics with the same grade, add the following (per unit):
 - › \$65 List for lounge chairs and ottomans
 - › \$105 List for love seats, lounge chair with bench seat and benches
 - › \$130 List for love seat with bench seat and sofas
- When combining **three or more** COM/COV/COL fabrics, or fabrics with the same grade, add the following (per unit):
 - › \$75 List for lounge chairs and ottomans

- › \$115 List for love seats, lounge chair with bench seat and benches
- › \$140 List for love seat with bench seat and sofas

- When combining different grades of fabric, price will be based on the highest grade specified.
- Note: Yardage amounts are based on fabric which is plain (i.e. non-directional) and a full 54" wide.
- **Appropriate upholstery code must be included on order.**

**DOMO
MODULAR**

designed by qdesign



SIN #711-16



Code DL3
Model COM Requirement
 6101 Seat Cushion Only = 1¹/₄ yds.
 Balance of Chair = 3¹/₂ yds.

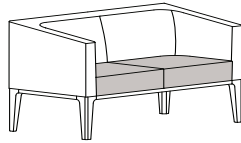

Code DL4
Model COM Requirement
 6102 Seat Cushion Only = 1¹/₂ yds.
 Balance of Love Seat = 3¹/₂ yds.

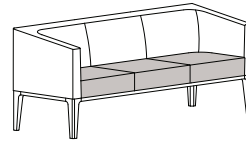

Code DL5
Model COM Requirement
 6103 Seat Cushion Only = 2¹/₂ yds.
 Balance of Sofa = 4 yds.

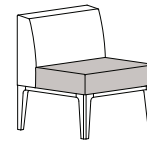

Code DL6
Model COM Requirement
 6110 Seat Cushion Only = 1 yd.
 Balance of Chair = 1¹/₄ yds.

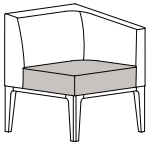

Code DL7
Models COM Requirement
 6110-L Seat Cushion Only = 1 yd.
 6110-R Balance of Chair = 2 yds.

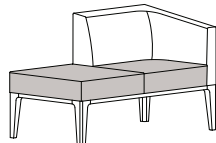

Code DL8
Models COM Requirement
 6110-BR Seat Cushion &
 6110-BL Bench Seat Only = 1³/₄ yds.
 Balance of Unit = 2 yds.

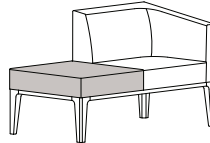

Code DL9
Models COM Requirement
 6110-BL Bench Seat Only = 1 yd.
 6110-BR Balance of Unit = 2³/₄ yds.

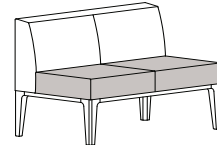

Code DL10
Model COM Requirement
 6120 Seat Cushion Only = 1³/₄ yds.
 Balance of Love Seat = 2 yds.

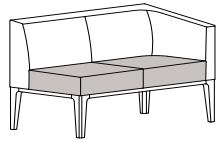

Code DL11
Models COM Requirement
 6120-R Seat Cushion Only = 1³/₄ yds.
 6120-L Balance of Love Seat = 2³/₄ yds.

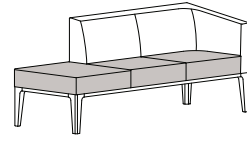

Code DL12
Models COM Requirement
 6120-BR Seat Cushion &
 6120-BL Bench Seat Only = 2¹/₂ yds.
 Balance of Unit = 2³/₄ yds.

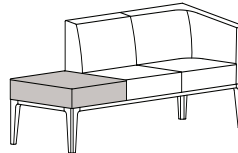

Code DL13
Models COM Requirement
 6120-BL Bench Cushion Only = 1 yd.
 6120-BR Balance of Unit = 4¹/₄ yds.

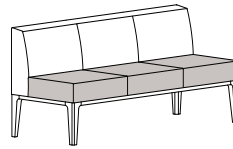

Code DL14
Model COM Requirement
 6130 Seat Cushion Only = 2¹/₂ yds.
 Balance of Sofa = 2³/₄ yds.

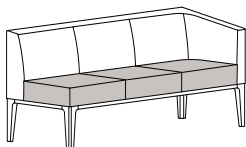

Code DL15
Models COM Requirement
 6130-R Seat Cushion Only = 2¹/₂ yds.
 6130-L Balance of Sofa = 3¹/₄ yds.

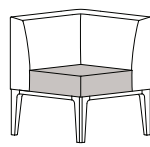

Code DL16
Model COM Requirement
 6140 Seat Cushion Only = 1 yd.
 Balance of Chair = 2 yds.



Code DL17
Model COM Requirement
 6145 Seat Cushion Only = 1¹/₂ yds.
 Balance of Chair = 2¹/₂ yds.

DOMO MODULAR

designed by qdesign



UPHOLSTERY COMBINATIONS:

For fabric, vinyl or leather upholstery combinations, refer to the pricing below:

- When combining **two** COM/COV/COL fabrics, or fabrics with the same grade, add the following (per unit):
 - › \$65 List for lounge chairs and ottomans
 - › \$105 List for love seats, lounge chair with bench seat and benches
 - › \$130 List for love seat with bench seat and sofas
- When combining **three or more** COM/COV/COL fabrics, or fabrics with the same grade, add the following (per unit):
 - › \$75 List for lounge chairs and ottomans

- › \$115 List for love seats, lounge chair with bench seat and benches
- › \$140 List for love seat with bench seat and sofas

- When combining different grades of fabric, price will be based on the highest grade specified.
- Note: Yardage amounts are based on fabric which is plain (i.e. non-directional) and a full 54" wide.
- **Appropriate upholstery code must be included on order.**

SIN #711-16

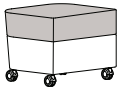

Code DL18

Model COM Requirement
6150 Seat Cushion Only = 1¹/₄ yds.
Balance of Ottoman = 3³/₄ yd.

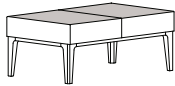

Code DL19

Model COM Requirement
6162 Top of Cushion Only = 1 yd.
Balance of Bench = 1 yd.

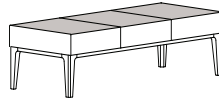

Code DL20

Model COM Requirement
6163 Top of Cushion Only = 1¹/₂ yds.
Balance of Bench = 1¹/₂ yds.

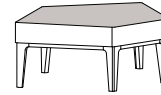

Code DL21

Model COM Requirement
6164 Top of Cushion Only = 1¹/₄ yds.
Balance of Bench = 1 yd.

NOTES:

- Tables manufactured in Maple, Walnut and White Oak veneer as well as laminate, in all standard and custom finishes. Refer to Domo Modular price list for edge finish specifications.
- For custom wood finishes, please add one-time upcharge of \$400 List per color per order.
- Corian top offered in four standard colors, specify “-CO” next to model number. Top is affixed to table top surface increasing overall table height by 1/2" and features 1/8" reveal.
- **Table with Corian top, wood edge species and finish selection must be specified.**
- Metal platform base available in #92 Polished Aluminum, #06 Charcoal Grey and #90 Metallic Silver.

SPECIFY:

1. Model number
2. Wood finish
3. Leg finish
4. Options, as applicable

ORDERING EXAMPLE:

#61-363615-CO-NS02B

36" Square Table
Corian Top
Non-Skid Glides

DOMO
OCCASIONAL TABLES

designed by qdesign

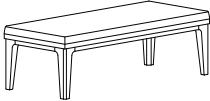
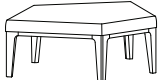
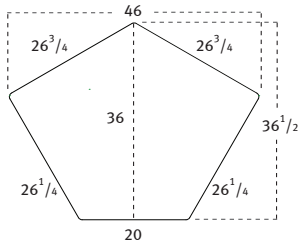

SIN #711-11

MODEL NUMBER		PRODUCT SPECIFICATIONS		TABLE TOP FINISH		
		MODEL NUMBER	VENEER OR LAMINATE	CORIAN (-CO)	WEIGHT	
61 	Domo Table 61 Series 3" Table Thickness	61-262615	1453	2195	44	
		61-363615	1701	3317	67	
		61-424215	2066	4265	86	
		61-482015	1692	2741	51	
6174 	120-Degree Pentagonal Table 3" Table Thickness	6174	1780	4269	56	
<p><i>Top View</i></p> 						

CORIAN® TOP COLORS:

- Designer White
- Linen
- Rain Cloud
- Witch Hazel

OPTIONS (XXXX - REFERS TO TABLE MODEL NUMBER)

MODEL	DESCRIPTION	LIST
XXXX-NS02B	Non-Skid Glides, Square/Rectangle Tables	20
XXXX-NS02C	Non-Skid Glides, 120-Degree Pentagonal Tables	25



FLIRT® GUEST

designed by 5d studio



SIN #711-18

PRODUCT FEATURES:

- 4-leg and swivel base models available.
- 4-leg base available with chrome casters or on glides (chrome finish only).
- Casters suitable for carpet or hard-surface floors.
- Flip-up or fixed seat options.
- Swivel base model features auto-return as standard. Fixed seat only.
- Swivel base model not available with casters.
- All base styles available in standard and premium metal finishes.
- Non-skid glides for hard-surface floors available on 4-leg base with glides or swivel base. Refer to individual pages for option code and applicable upcharges.
- Maximum weight capacity of 350 lbs.
- Features prominent stitching detail.
- Two-tone upholstery examples and yardage requirements featured on page 4.

STANDARD BASE FINISH COLORS:

#06 Charcoal Grey #92 Polished Aluminum
#90 Metallic Silver #95 Satin Black

PREMIUM BASE FINISH COLORS:

#07 Gold Shimmer #83 Metallic Champagne
#08 Penny #94 Cotton
#09 Brown Sugar

FLIP-UP ROTATING TABLET:

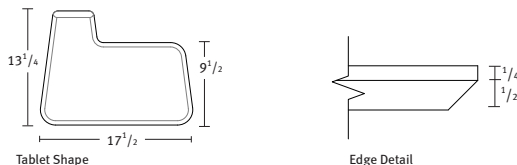

- Tablet features flip-up capability in addition to 120-degree turning radius.
- Nesting chairs with tablets maintain nesting capability.
- Tablet dimensions: 17 1/2" W x 13 1/4" D x 3/4" thick.
- Available in veneer and laminate surface options.
- Tablet veneer surface offered in Maple, Walnut and White Oak, in all standard and custom wood finishes. Edge will always match the top finish color, unless otherwise specified.
- For custom wood finishes, please add one-time upcharge of \$400 List per color per order.
- Laminate is applied to tablet top surface only.
- For standard laminates, refer to Standard Finish Card.
- For custom laminates, add \$500 List per color per order. Pre-approval required, please contact Customer Service.
- For standard wood grain laminates, edge finish will match the laminate top color, unless otherwise specified.
- For standard color laminates, edge finish be natural (clear coat) as standard, unless otherwise specified.
- Tablet mounting bracket finish will be as follows:
 - › For bases specified with #90 Metallic Silver finish, tablet bracket will be #90 Metallic Silver.
 - › For bases specified with #92 Polished Aluminum, tablet bracket will be #92 Polished Aluminum.
 - › For bases specified in #06 Charcoal Grey or #95 Satin Black, tablet bracket will be #92 Polished Aluminum as standard. If matching finishes is required, please specify and add \$110 to List Price per unit.
 - › For bases specified in premium finish colors, tablet bracket will match as standard, unless otherwise specified.

FLIRT® GUEST

designed by 5d studio



SIN #711-18

NESTING DIMENSIONS*:

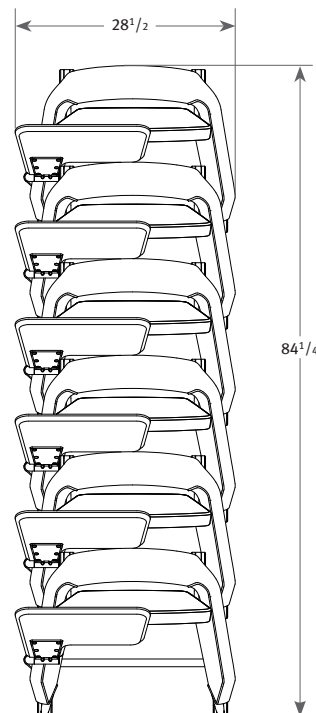
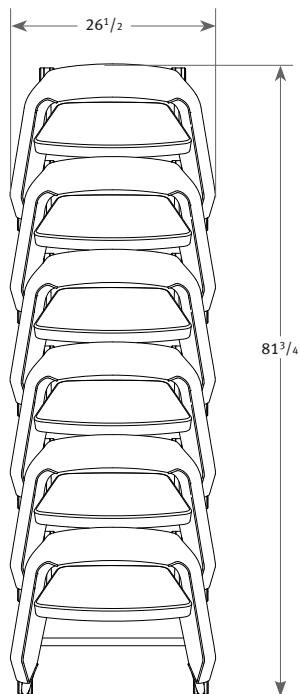
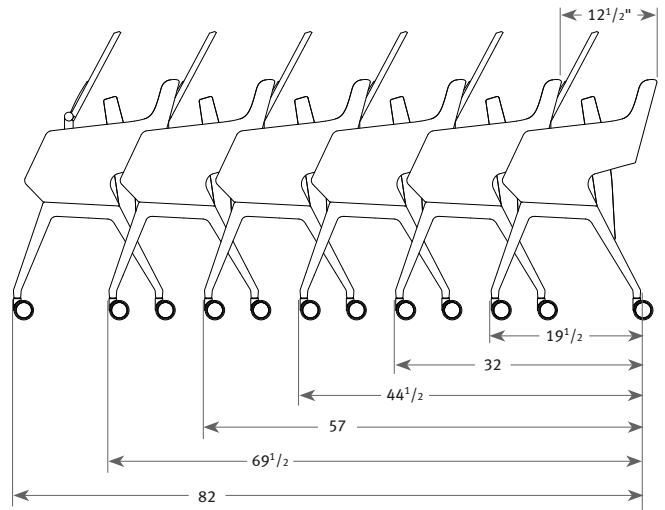
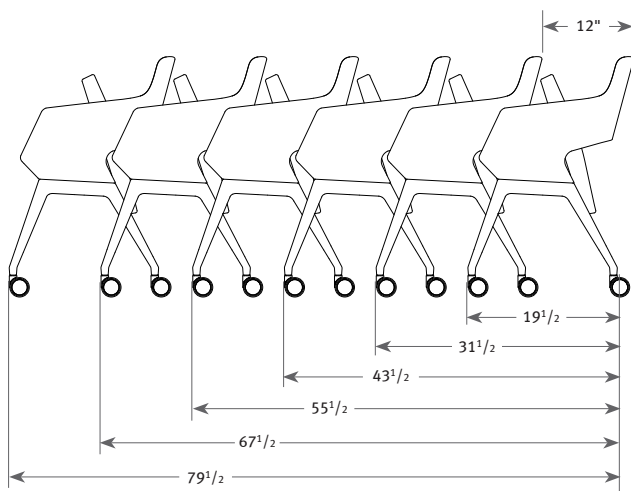

*Dimensions are nominal and based on the average distance between nested chairs.

NOTES:

- 4-leg guest chair available with casters or on glides, with fixed or flip-up seat options.
- Swivel base model features auto-return as standard. Fixed seat only.
- Metal frame available in standard and premium finish selections.
- Optional flip-up rotating tablet available in veneer or laminate. Refer to page 1 for details.
- Refer to page 3 for two-tone upholstery examples and yardage requirements.

SPECIFY:

1. Model number
2. Frame finish
3. Upholstery selection
4. Options, as applicable

ORDERING EXAMPLE:

#6910-TAR06-PF06



4-Leg Chair, Casters
Tablet Arm, Right
Premium Finish

FLIRT®
GUEST

designed by 5d studio



SIN #711-18

MODEL NUMBER	PRODUCT SPECIFICATIONS	FABRIC GRADES								LEATHER GRADES			
		COM	1	2	COL			7	8	L1	L2	L3	
6910	 <p>Q S 4-Leg Guest Chair, Flip-Up Seat, Casters W 27 D 24 H 32 Seat Height 18 Inside Seat Width 19 Inside Seat Depth 19 Arm Height 25 2¹/₄ yds. 34 lbs. TB 133, add \$108 List</p>	1356	1484	1515	1569	1623	1675	1730	1779	1834	2082	2264	2441
6915	 <p>Swivel Base Guest Chair, Fixed Seat W 27 D 24 H 32 Seat Height 18 Inside Seat Width 19 Inside Seat Depth 19 Arm Height 25 2¹/₄ yds. 34 lbs. TB 133, add \$108 List</p>	1360	1488	1519	1573	1627	1679	1734	1783	1838	2086	2268	2445

OPTIONS (XXXX - REFERS TO CHAIR MODEL NUMBER)

MODEL	DESCRIPTION	LIST
XXXX-FS01	Fixed Seat, 4-Leg Base Model Only	25
XXXX-GD03	Glides, 4-Leg Base (Chrome finish only)	n/c
XXXX-NS04	Non-Skid Glides, Swivel Base	20
XXXX-TAR06	Veneer/Laminate Tablet, Right (as seated)	425
XXXX-TAL06	Veneer/Laminate Tablet, Left (as seated)	425
XXXX-PF06	Premium Finish (base and tablet bracket)	220

Q S = Available on Quick-Ship Program (Polished Aluminum and Metallic Silver finishes only).

FLIRT® GUEST

designed by 5d studio



UPHOLSTERY COMBINATIONS:

For fabric, vinyl or leather upholstery combinations, refer to the pricing below:

- When combining **two** COM/COV/COL fabrics, or fabrics with the same grade, add \$45 List per unit.
- When combining **three or more** COM/COV/COL fabrics, or fabrics with the same grade, add \$55 List per unit.
- When combining different grades of fabric, price will be based on the highest grade specified.
- Two-tone upholstery examples and yardage requirements for the most common combinations are listed below. Additional combinations available, please contact Customer Service for yardage requirements and pricing.
- Note: Yardage amounts are based on fabric which is plain (i.e. non-directional) and a full 54" wide.
- **Appropriate upholstery code must be included on order.**

SIN #711-18



<u>Code</u>	<u>FL1</u>
<u>Models</u>	<u>COM Requirement</u>
6910	Back = 1 ¹ / ₄ yds.
6915	Seat = 1 yd.



FLIRT® LOUNGE

designed by 5d studio



SIN #711-16

PRODUCT FEATURES:

- Mid and high back models available with 4-leg and swivel base options.
- 4-leg base available with chrome casters or on glides (chrome finish only).
- Casters suitable for carpet or hard-surface floors.
- Flip-up or fixed seat options.
- Swivel base model features auto-return as standard. Fixed seat only.
- Swivel base model not available with casters.
- All base styles available in standard and premium metal finishes.
- Non-skid glides for hard-surface floors available on 4-leg base with glides or swivel base.
- Maximum weight capacity of 350 lbs.
- Optional under seat book rack with 14^{3/4}" W x 11^{1/2}" D x 7^{1/2}" H storage space and 3" height clearance from the floor, available on 4-leg frames only. Book rack will match leg finish as standard, unless otherwise specified.
- Features prominent stitching detail.
- Two-tone upholstery examples and yardage requirements featured on page 5.

STANDARD BASE FINISH COLORS:

#06 Charcoal Grey #92 Polished Aluminum
#90 Metallic Silver #95 Satin Black

PREMIUM BASE FINISH COLORS:

#07 Gold Shimmer #83 Metallic Champagne
#08 Penny #94 Cotton
#09 Brown Sugar

FLIP-UP ROTATING TABLET:

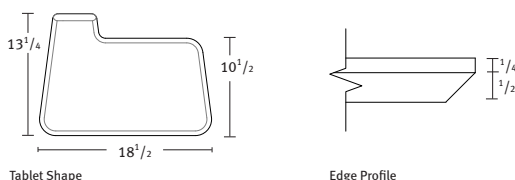

- Tablet features flip-up capability in addition to 120-degree turning radius.
- Nesting chairs with tablets maintain nesting capability.
- Tablet dimensions: 18^{1/2}" W x 13^{1/4}" D x 3/4" thick.
- Available in veneer and laminate surface options.
- Tablet veneer surface offered in Maple, Walnut and White Oak, in all standard and custom wood finishes. Edge will always match the top finish color, unless otherwise specified.
- For custom wood finishes, please add one-time upcharge of \$400 List per color per order.
- Laminate is applied to tablet top surface only.
- For standard laminates, refer to Standard Finish Card.
- For custom laminates, add \$500 List per color per order. Pre-approval required, please contact Customer Service.
- For standard wood grain laminates, edge finish will match the laminate top color, unless otherwise specified.
- For standard color laminates, edge finish be natural (clear coat) as standard, unless otherwise specified.
- Tablet mounting bracket finish will be as follows:
 - › For bases specified with #90 Metallic Silver finish, tablet bracket will be #90 Metallic Silver.
 - › For bases specified with #92 Polished Aluminum, tablet bracket will be #92 Polished Aluminum.
 - › For bases specified in #06 Charcoal Grey or #95 Satin Black, tablet bracket will be #92 Polished Aluminum as standard. If matching finishes is required, please specify and add \$110 to List Price per unit.
 - › For bases specified in premium finish colors, tablet bracket will match as standard, unless otherwise specified.

FLIRT® LOUNGE

designed by 5d studio



SIN #711-16

NESTING DIMENSIONS*:

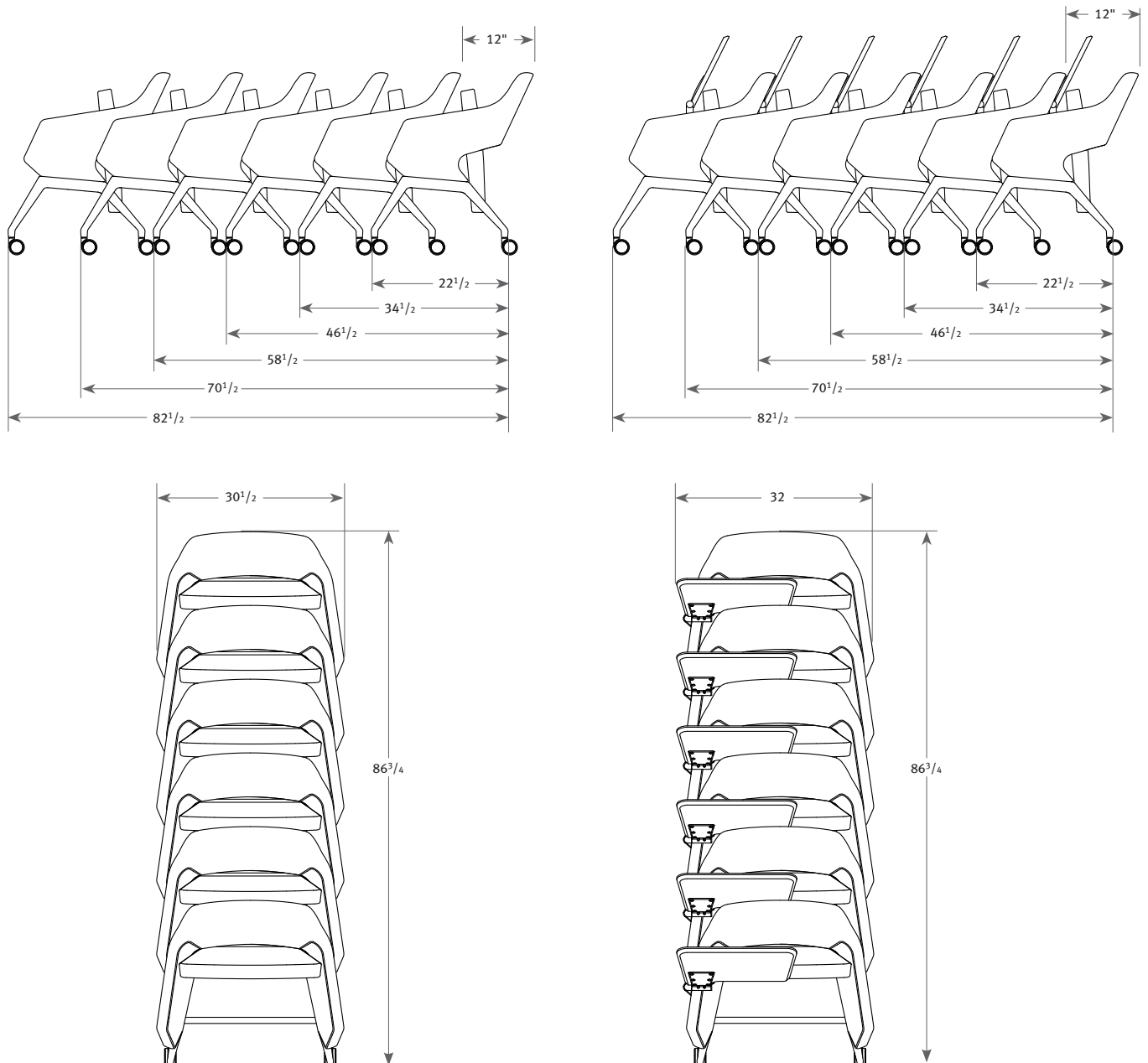

*Dimensions are nominal and based on the average distance between nested chairs.

NOTES:

- Mid and high back models.
- Metal frame available in standard and premium finish selections.
- Optional flip-up rotating tablet available in Maple, Walnut and White Oak veneer or laminate. Refer to page 1 for details.
- Optional under seat book rack features 3" height clearance.
- Refer to page 5 for two-tone upholstery examples and yardage requirements.

SPECIFY:

1. Model number
2. Frame finish
3. Upholstery selection
4. Options, as applicable

ORDERING EXAMPLE:

#6920-C-TAR07-BK01



Nesting Lounge Chair, Casters
Tablet, Right Side
Book Rack

**FLIRT®
LOUNGE**

designed by 5d studio



SIN #711-16

MODEL NUMBER	PRODUCT SPECIFICATIONS	FABRIC GRADES							LEATHER GRADES				
		COM	1	2	COL 3	4	5	6	7	8	L1	L2	L3
6920 	4-Leg Mid-Back Lounge Chair, Flip-Up Seat, Casters W 31 D 28 ³ / ₄ H 30 ¹ / ₂ Seat Height 16 ¹ / ₂ Inside Seat Width 21 Inside Seat Depth 21 Arm Height 22 ¹ / ₂ 2 ¹ / ₂ yds. 40 lbs. TB 133, add \$120 List	1627	1769	1803	1864	1924	1982	2042	2097	2158	2433	2635	2832
6921 	4-Leg High Back Lounge Chair, Flip-Up Seat, Casters W 31 D 30 ¹ / ₄ H 39 ³ / ₄ Seat Height 16 ¹ / ₂ Inside Seat Width 21 Inside Seat Depth 21 Arm Height 22 ¹ / ₂ 2 ³ / ₄ yds. 43 lbs. TB 133, add \$132 List	1691	1847	1885	1951	2018	2081	2148	2208	2275	2578	2800	3017

OPTIONS (XXXX - REFERS TO CHAIR MODEL NUMBER)

MODEL	DESCRIPTION	LIST
XXXX-FS01	Fixed Seat	25
XXXX-GD03	Glides (chrome finish only)	n/c
XXXX-TAR07	Veneer/Laminate Tablet, Right (as seated)	425
XXXX-TAL07	Veneer/Laminate Tablet, Left (as seated)	425
XXXX-BK01	Book Rack	160
XXXX-PF06	Premium Finish (base, tablet bracket and book rack)	220

FLIRT® LOUNGE

designed by 5d studio



SIN #711-16

NOTES:

- Mid and high back models.
- Swivel base model features auto-return as standard. Fixed seat only.
- Metal frame available in standard and premium finish selections.
- Optional flip-up rotating tablet available in Maple, Walnut and White Oak veneer or laminate. Refer to page 1 for details.
- Refer to page 5 for two-tone upholstery examples and yardage requirements.



SPECIFY:

1. Model number
2. Frame finish
3. Upholstery selection
4. Options, as applicable

ORDERING EXAMPLE:

#6926-TAR07

Swivel Base Lounge Chair
Tablet, Right Side

MODEL NUMBER	PRODUCT SPECIFICATIONS	FABRIC GRADES							LEATHER GRADES							
		COM	1	2	COL			3	4	5	6	7	8	L1	L2	L3
6925	 <p>Swivel Base Mid-Back Lounge Chair, Fixed Seat W 31 D 28³/₄ H 30¹/₂ Seat Height 16¹/₂ Inside Seat Width 21 Inside Seat Depth 21 Arm Height 22¹/₂ 2¹/₂ yds. 40 lbs. TB 133, add \$120 List</p>	1724	1866	1900	1961	2021	2079	2139	2194	2255	2530	2732	2929			
6926	 <p>Swivel Base High Back Lounge Chair, Fixed Seat W 31 D 30¹/₄ H 39³/₄ Seat Height 16¹/₂ Inside Seat Width 21 Inside Seat Depth 21 Arm Height 22¹/₂ 2³/₄ yds. 42 lbs. TB 133, add \$132 List</p>	1805	1961	1999	2065	2132	2195	2262	2322	2389	2692	2914	3131			

OPTIONS (XXXX - REFERS TO CHAIR MODEL NUMBER)

MODEL	DESCRIPTION	LIST
XXXX-NS09	Non-Skid Glides, Swivel Base	20
XXXX-TAR07	Veneer/Laminate Tablet, Right (as seated)	425
XXXX-TAL07	Veneer/Laminate Tablet, Left (as seated)	425
XXXX-PF06	Premium Finish (base and tablet bracket)	220

UPHOLSTERY COMBINATIONS:

For fabric, vinyl or leather upholstery combinations, refer to the pricing below:

- When combining **two** COM/COV/COL fabrics, or fabrics with the same grade, add \$65 List per unit.
- When combining **three or more** COM/COV/COL fabrics, or fabrics with the same grade, add \$75 List per unit.
- When combining different grades of fabric, price will be based on the highest grade specified.
- Two-tone upholstery examples and yardage requirements for the most common combinations are listed below. Additional combinations available, please contact Customer Service for yardage requirements and pricing.
- Note: Yardage amounts are based on fabric which is plain (i.e. non-directional) and a full 54" wide.
- **Appropriate upholstery code must be included on order.**

**FLIRT®
LOUNGE**

designed by 5d studio



SIN #711-16



Code **FL2**
Models COM Requirement
6920 Back = 1¹/₂ yds.
6925 Seat = 1 yd.



Code **FL3**
Models COM Requirement
6921 Back = 1³/₄ yds.
6926 Seat = 1 yd.

FLIRT® MEETING TABLES

designed by 5d studio



SIN #711-11

PRODUCT FEATURES:

- Round and arc square top shapes.
- Three table heights: 26", 29" and 42".
- Custom heights up to 42" available, please specify and add \$200 List upcharge per unit. Price is based on the higher standard table height (e.g. 32" custom height, price is based on the 42" standard height plus \$200).
- Table column diameter: 2¹/₄".
- Four table surface options: veneer, laminate, Corian or back-painted glass.
- Veneer offered in Maple, Walnut and White Oak wood species.
- All standard and custom wood finishes available.
- For custom wood finishes, please add one-time upcharge of \$400 List per color per order.
- Laminate tops available in all Arcadia standard laminates.
- For custom laminates, add \$500 List per color per order. Pre-approval required, please contact Customer Service.
- Corian top available in four standard colors.
- Glass is back-painted white as standard and may be used as a writable surface with dry-erase markers.
- For non-standard Corian or back-painted glass colors, please contact Customer Service for pricing.
- Metal pedestal base manufactured in aluminum and offered in standard as well as premium finish selections.
- For custom finish colors, please contact Customer Service for pricing.
- Base standard with adjustable glides.
- Non-skid glide option available for hard-surface floors. Please specify "-NS04" after model number and add \$20 List per unit.
- Base design facilitates wire management for through-the-surface electrical and/or data capability.
- All dimensions are nominal.

EDGE DETAIL FEATURES:

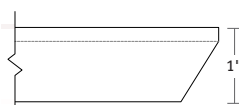

Veneer/Laminate Top - Edge Profile



Corian Top - Edge Profile

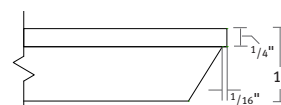

Back-Painted Glass - Edge Profile

- Beveled edge detail.
- Table with veneer or standard wood grain laminate top, edge finish will match top finish color, unless otherwise specified.
- For all other finishes (solid color laminates, Corian and back-painted glass), edge will be natural exposed plywood with a clear coat finish as standard, unless otherwise specified.
- For Corian tops, a 1/8" reveal will be present.

FLIRT® MEETING TABLES

designed by 5d studio



SIN #711-11

CORIAN® COLORS:

Designer White
Linen
Rain Cloud
Witch Hazel

Corian® is a registered trademark of Dupont.

STANDARD BASE FINISH COLORS:

#06 Charcoal Grey #92 Polished Aluminum
#90 Metallic Silver #95 Satin Black

PREMIUM BASE FINISH COLORS:

#07 Gold Shimmer #83 Metallic Champagne
#08 Penny #94 Cotton
#09 Brown Sugar

PORTAL POWER UNITS:

- Available on all table sizes and heights.
- Dimensions: 5¹/₄" W x 4¹/₄" L
- Touch latch lid provides easy access to data and electrical features.
- Satin nickel finish.

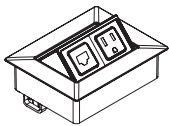

PP1

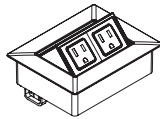

PP2

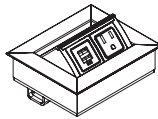

PP3

- PP1 unit features one simplex outlet with 72" electrical cord and one RJ-45 jack (Cat 6) with 72" patch cable.
- PP2 unit features two simplex outlets with 72" electrical cord.
- PP3 unit features one simplex outlet with 72" electrical cord and two USB charging ports.

NOTES:

- Available in Maple, Walnut and White Oak veneer, as well as laminate, Corian and back-painted glass.
- Base available in all standard and premium metal finishes.

SPECIFY:

1. Model number
2. Wood species, as applicable
3. Wood finish, as applicable
4. Base finish
5. Options, as applicable

ORDERING EXAMPLE:

#FX8-3629-BV-CO-PP1



36" Dia. x 29" H Round Table
Corian Top
Portal Power 1 Unit

FLIRT®
MEETING TABLES

designed by 5d studio



SIN #711-11

		MODEL NUMBER	VENEER OR LAMINATE	CORIAN (-CO)	BACK-PAINTED GLASS (-PG)	WEIGHT
FX8 SERIES 	Q S Round Top, 26" High 29" Dia. x 26" H 36" Dia. x 26" H 42" Dia. x 26" H	FX8-2926-BV	1420	2342	1871	33
		FX8-3626-BV	1624	3147	2118	43
		FX8-4226-BV	1922	3996	2473	54
	Q S Round Top, 29" High 29" Dia. x 29" H 36" Dia. x 29" H 42" Dia. x 29" H	FX8-2929-BV	1468	2390	1919	34
		FX8-3629-BV	1672	3195	2167	44
		FX8-4229-BV	1970	4044	2522	55
	Q S Round Top, 42" High 29" Dia. x 42" H 36" Dia. x 42" H	FX8-2942-BV	1626	2548	2075	37
		FX8-3642-BV	1829	3352	2324	47

OPTIONS (XXXX - REFERS TO TABLE MODEL NUMBER)

MODEL	DESCRIPTION	LIST
XXXX-NS04	Non-Skid Glides	20
XXXX-PF03	Premium Base Finish	110
XXXX-PP1	Portal Power 1 (1 Power, 1 Data)	612
XXXX-PP2	Portal Power 2 (Dual Power)	542
XXXX-PP3	Portal Power 3 (1 Power, 2 USB)	643

Q S = Available on Quick-Ship Program, all sizes and surface materials (Polished Aluminum and Metallic Silver base finishes only).

FLIRT[®] MEETING TABLES

designed by 5d studio

NOTES:

- Available in Maple, Walnut and White Oak veneer, as well as laminate, Corian and back-painted glass.
- Base available in all standard and premium metal finishes.



SPECIFY:

1. Model number
2. Wood species, as applicable
3. Wood finish, as applicable
4. Base finish
5. Options, as applicable

ORDERING EXAMPLE:

#FX9-303042-BV-PF03-PP2
30" x 30" x 42" Arc-Square Table
Premium Base Finish
Portal Power 2 Unit

SIN #711-11

		MODEL NUMBER	VENEER OR LAMINATE	CORIAN (-CO)	BACK-PAINTED GLASS (-PG)	WEIGHT
	Q S Arc-Square Top, 26" Height 30" W x 30" L x 26" H 36" W x 36" L x 26" H 42" W x 42" L x 26" H	FX9-303026-BV	1433	2355	2014	33
		FX9-363626-BV	1637	3161	2282	43
		FX9-424226-BV	1941	4014	2666	54
	Q S Arc-Square Top, 29" Height 30" W x 30" L x 29" H 36" W x 36" L x 29" H 42" W x 42" L x 29" H	FX9-303029-BV	1481	2402	2066	34
		FX9-363629-BV	1686	3209	2334	44
		FX9-424229-BV	1988	4062	2718	55
	Q S Arc-Square Top, 42" Height 30" W x 30" L x 42" H 36" W x 36" L x 42" H	FX9-303042-BV	1637	2559	2234	37
		FX9-363642-BV	1843	3367	2502	47

OPTIONS (XXXX - REFERS TO TABLE MODEL NUMBER)

MODEL	DESCRIPTION	LIST
XXXX-NS04	Non-Skid Glides	20
XXXX-PF03	Premium Base Finish	110
XXXX-PP1	Portal Power 1 (1 Power, 1 Data)	612
XXXX-PP2	Portal Power 2 (Dual Power)	542
XXXX-PP3	Portal Power 3 (1 Power, 2 USB)	643

Q S = Available on Quick-Ship Program, all sizes and surface materials (Polished Aluminum and Metallic Silver base finishes only).

FLIRT® MULTI-PURPOSE

designed by 5d studio



SIN #711-11

TABLE TOP FEATURES:

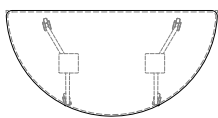

Half-Round



Rectangle

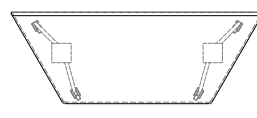

Trapezoid - Long Side

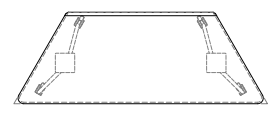

Trapezoid - Short Side

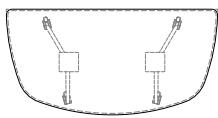

Radiused End

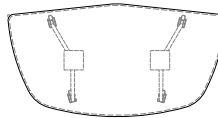

Video Conference End

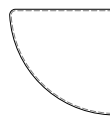

Corner

- Fixed and flip-up tables available in half-round, rectangle, trapezoid, radiused end and video conference end top shape options.
- Corner table is fixed only (for connecting purposes, no base attached). Connecting plates included.
- Flip-up tables feature a single-lever release mechanism for quick and easy set-up and storage.
- Table tops offered in Maple, Walnut and White Oak veneer, as well as laminate selections.
- All standard wood finishes, excluding #26 Ebony Maple, available on selected wood species.
- For custom wood finishes, please add one-time upcharge of \$400 List per color per order.
- Laminate tops available in all Arcadia standard laminates.
- For custom laminates, add \$500 List per color per order. Pre-approval required, please contact Customer Service.
- Unless specified, wood grain direction will run lengthwise on all tables.

TABLE EDGE FEATURES:

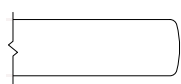

Eased (ES)

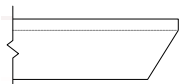

Beveled (BV)

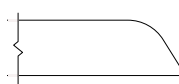

Waterfall (WF)

- All edges are 1" thick.
- Eased and Beveled edge styles available on all tables.
- Waterfall edge available on rectangle and trapezoid tables. Available on one or two sides, with Beveled edge featured on remaining sides.
- Eased and Beveled edge finish will match veneer or standard wood grain laminate table top finish color, unless otherwise specified.
- For standard solid color laminates, Eased and Beveled edge will be natural exposed plywood with a clear coat finish, as standard.
- For waterfall edge finish, laminate tops are post-formed to deliver a seamless finish from the top surface to the edge underside.

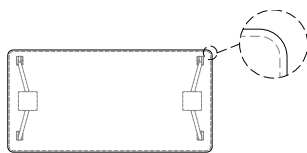

Beveled edge tables will have radiused corners

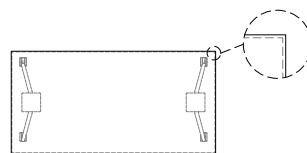

Eased edge tables will have 90-degree corners

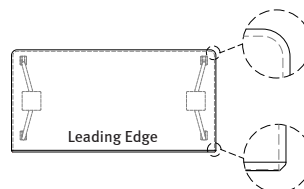

One-sided waterfall edge tables will have 90-degree corner on leading edge and radiused corner on opposing side

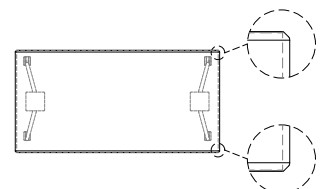

Two-sided waterfall edge tables will have 90-degree corners on all sides

FLIRT® MULTI-PURPOSE

designed by 5d studio



SIN #711-11

BASE FEATURES:

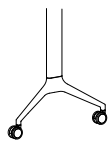

4-Leg Base, Casters

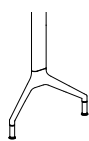

4-Leg Base, Glides

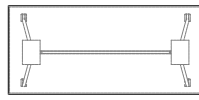

Edge Mount

Provides additional leg space between base columns

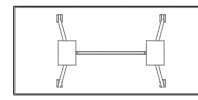

Inset Mount

Provides seating space at table ends

- Die-cast aluminum legs available in standard and premium metal finishes.
- Interior leg column features removable cover for vertical wire management.
- Mobile version standard with 4 locking chrome casters that are suitable for carpet and hard-surface floors.
- Glides presented in chrome finish and are non-adjustable.
- Non-skid glides available for hard-surface floors.
- Fixed top tables 78" in length and greater, as well as all 42" high tables, feature a stretcher bar for added stability. Stretcher bar will match leg finish as standard, unless otherwise specified.
- Edge mount bases are positioned 3" from table edge for additional leg space. Available on rectangle and trapezoid top shapes only.
- Inset mount bases are positioned 15" from table edge to provide seating on all sides.

STANDARD BASE FINISH COLORS:

- #06 Charcoal Grey
- #92 Polished Aluminum
- #90 Metallic Silver
- #95 Satin Black

PREMIUM BASE FINISH COLORS:

- #07 Gold Shimmer
- #83 Metallic Champagne
- #08 Penny
- #94 Cotton
- #09 Brown Sugar

CONNECTING TABLE MECHANISM FEATURES:

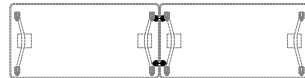
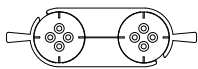

- Ordered separately, ganging mechanism comes two per set to connect two tables together (end-to-end, side-to-side, end-to-side, etc.).
- **Please include layout drawings or sketch with each order to ensure proper ganging bracket placement location.**

MODESTY PANEL PRODUCT FEATURES:

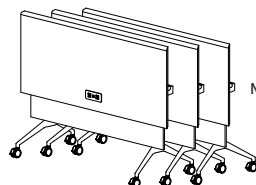
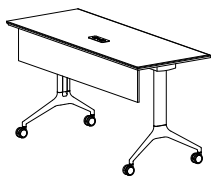

Nested front view

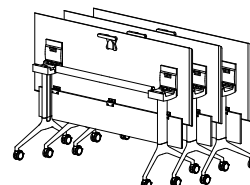

Nested rear view

- 9" wide x 1/2" thick panels available on fixed or flip-up rectangle and trapezoid tables.
- Offered in Maple, Walnut and White Oak, in all standard and custom wood finishes, as well as laminate selections.
- Panels specified with veneer or standard wood grain laminate, edge finish will match, unless otherwise specified.
- Panels specified with standard solid color laminates, edge finish will be natural exposed plywood with a clear coat finish, as standard.
- Finish is applied to both sides of modesty panel.
- Panels flip downward when applied to flip-up tables to maintain nesting capability.
- In-field installation required.

FLIRT® MULTI-PURPOSE

designed by 5d studio



SIN #711-11

POWER BAND CORDED UNITS:

- Available on all flip-up and fixed tables, excluding Corner connecting tables.
- PB1 and PB2 dimensions: 5³/₄" W x 2¹/₂" D
- PB3 dimensions: 6¹/₂" W x 2¹/₂" D
- Metallic Silver or White finish with 108" electrical cord.
- UL listed.
- PB1 unit features one outlet and two USB charging ports.
- PB2 unit features two outlets.
- PB3 unit features two outlets and two USB charging ports.
- Clips for horizontal wire management affixed to underside of table tops for convenient accessibility (included only when power is specified).
- Note: Power units not available on tables with modesty panels and inset mount legs.
- For daisy chain requirements and pricing, please refer to pages 6-8.



PB1

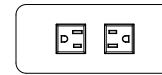

PB2

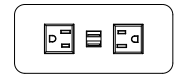

PB3

POWER UNIT STANDARD LOCATIONS (FOR CUSTOM PLACEMENT, PLEASE CONTACT CUSTOMER SERVICE):

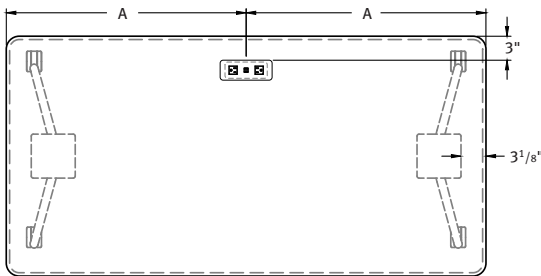

Rectangle Table - 1 Power Unit

LENGTH	A
48"	24"
60"	30"
66"	33"
72"	36"
78"	39"
84"	42"

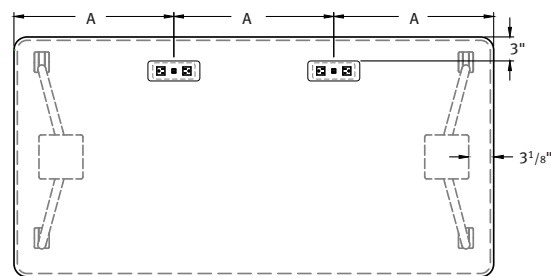

Rectangle Table - 2 Power Units

LENGTH	A
48"	16"
60"	20"
66"	22"
72"	24"
78"	26"
84"	28"

FLIRT® MULTI-PURPOSE

designed by 5d studio



SIN #711-11

POWER UNIT STANDARD LOCATIONS CONTINUED (FOR CUSTOM PLACEMENT, PLEASE CONTACT CUSTOMER SERVICE):

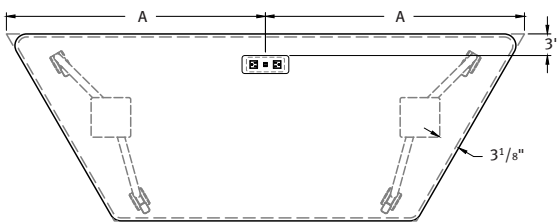

Trapezoid Table, Long Side - 1 Power Unit

LENGTH	A
48"	24"
60"	30"
72"	36"

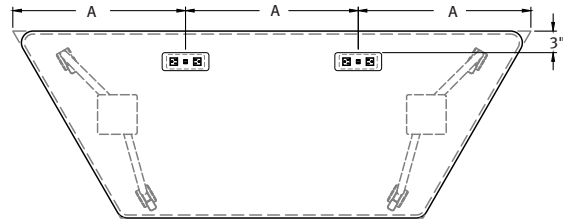

Trapezoid Table, Long Side - 2 Power Units

LENGTH	A
48"	16"
60"	20"
72"	24"

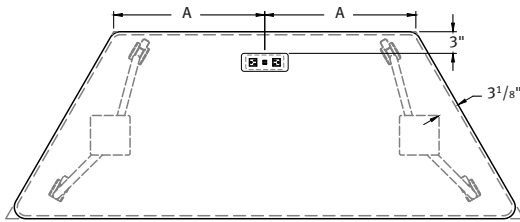

Trapezoid Table, Short Side - 1 Power Unit

LENGTH	A
48"	12"
24" x 60"	18"
30" x 60"	15"
72"	21"

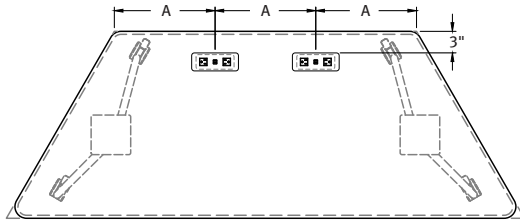

Trapezoid Table, Short Side - 2 Power Units

LENGTH	A
48"	8"
24" x 60"	12"
30" x 60"	10"
72"	14"

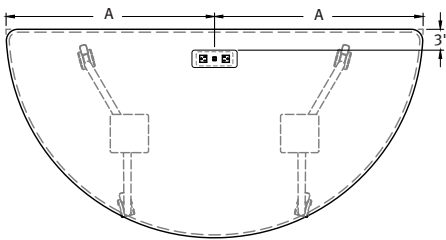

Half-Round Table - 1 Power Unit

LENGTH	A
48"	24"
60"	30"
72"	36"

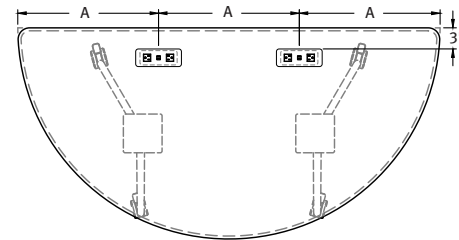

Half-Round Table - 2 Power Units

LENGTH	A
48"	16"
60"	20"
72"	24"

FLIRT® MULTI-PURPOSE

designed by 5d studio



SIN #711-11

POWER UNIT STANDARD LOCATIONS CONTINUED (FOR CUSTOM PLACEMENT, PLEASE CONTACT CUSTOMER SERVICE):

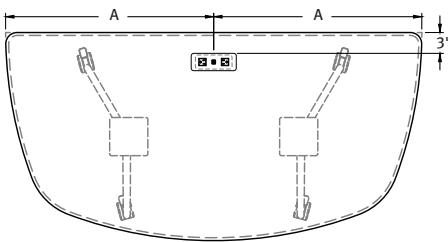

Radiused End Table - 1 Power Unit

LENGTH	A
48"	24"
60"	30"
72"	36"

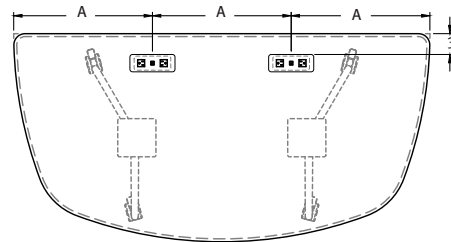

Radiused End Table - 2 Power Units

LENGTH	A
48"	16"
60"	20"
72"	24"

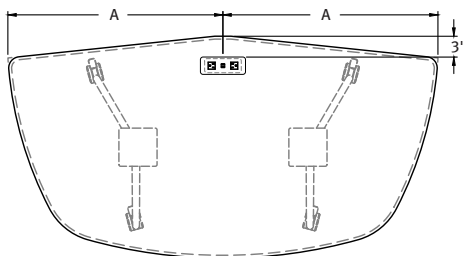

Video Conference End Table - 1 Power Unit

LENGTH	A
48"	25"
60"	31"
72"	37"

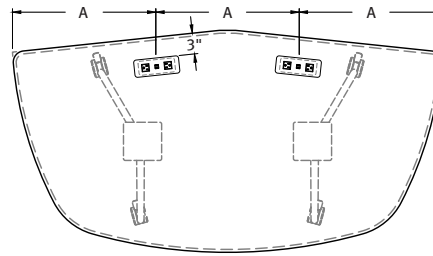

Video Conference End Table - 2 Power Units

LENGTH	A
48"	16.67"
60"	20.67"
72"	24.67"

FLIRT® MULTI-PURPOSE

designed by 5d studio



SIN #711-11

GROMMET:



- Available on all flip-up and fixed tables, excluding Corner connecting table.
- Dimensions: 2" Outer Diameter x 1⁵/₈" Inner Diameter x ⁵/₈" Deep.
- ⁵/₈" cord slot.
- Available in black and chrome finishes.
- Please specify location on table surface.

DAISY CHAIN ELECTRICAL SPECIFICATIONS:

- Daisy chain units are required for end-to-end or ganging connections, as well as when two electrical units are specified on one top.
- To determine jumper cable length, measure length from edge of electrical unit to end of table.
- Every connection point must be a female-to-male or male-to-female connection (all daisy chain power units feature male ends).
- Note: Always disconnect cables prior to separating tables.

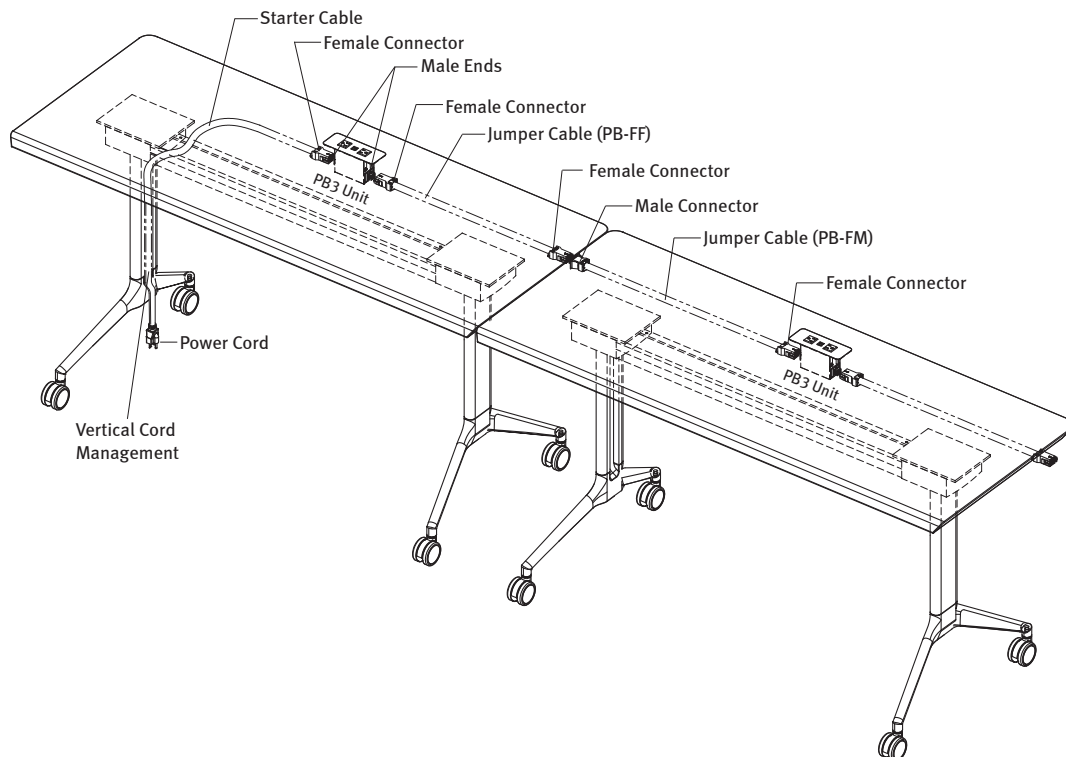



FLIRT® MULTI-PURPOSE

designed by 5d studio

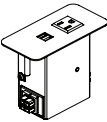
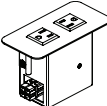
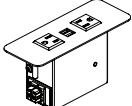
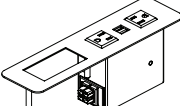

SIN #711-11

MODEL NUMBER	PRODUCT SPECIFICATIONS	LIST												
POWER BANDS WITH DAISY CHAIN FEATURE MALE ENDS														
<p>PB1-DC</p> 	<p>Power Band 1 Daisy Chain</p> <ul style="list-style-type: none"> ▪ Dimensions: 5³/₄" W x 2¹/₂" D ▪ Metallic Silver or White finish ▪ Unit features one simplex outlet and two USB charging ports. ▪ UL listed 	557												
<p>PB2-DC</p> 	<p>Power Band 2 Daisy Chain</p> <ul style="list-style-type: none"> ▪ Dimensions: 5³/₄" W x 2¹/₂" D ▪ Metallic Silver or White finish ▪ Unit features two simplex outlets ▪ UL listed 	442												
<p>PB3-DC</p> 	<p>Power Band 3 Daisy Chain</p> <ul style="list-style-type: none"> ▪ Dimensions: 6¹/₂" W x 2¹/₂" D ▪ Metallic Silver or White finish ▪ Unit features two simplex outlets and two USB charging ports ▪ UL listed 	546												
<p>PB4-DC</p> 	<p>Power Band 4 Daisy Chain</p> <ul style="list-style-type: none"> ▪ Dimensions: 10¹/₂" W x 2¹/₂" D ▪ Metallic Silver or Whitefinish ▪ Unit features two simplex outlets, two USB charging ports and cut-out for an A/V faceplate ▪ For available A/V faceplate options, please refer to Power/Data Technology price list ▪ UL Listed 	578												
<p>PB-ST-CD-72</p> 	<p>Power Band Starter Cable, 72" Long, Corded Plug Infeed</p> <ul style="list-style-type: none"> ▪ Must select either corded or hardwire starter cable which goes from power source in wall or floor to first Power Band Unit 	208												
<p>PB-ST-HW-()</p> 	<p>Power Band Starter Cable, Hardwire Infeed</p> <ul style="list-style-type: none"> ▪ Must select either corded or hardwire starter cable which goes from power source in wall or floor to first Power Band Unit <table border="1" data-bbox="446 1879 779 1995"> <thead> <tr> <th>MODEL</th> <th>LENGTH</th> <th>LIST</th> </tr> </thead> <tbody> <tr> <td>PB-ST-HW-72</td> <td>72"</td> <td>141</td> </tr> <tr> <td>PB-ST-HW-108</td> <td>108"</td> <td>177</td> </tr> <tr> <td>PB-ST-HW-120</td> <td>120"</td> <td>188</td> </tr> </tbody> </table>	MODEL	LENGTH	LIST	PB-ST-HW-72	72"	141	PB-ST-HW-108	108"	177	PB-ST-HW-120	120"	188	
MODEL	LENGTH	LIST												
PB-ST-HW-72	72"	141												
PB-ST-HW-108	108"	177												
PB-ST-HW-120	120"	188												

FLIRT® MULTI-PURPOSE

designed by 5d studio



SIN #711-11

MODEL NUMBER

PRODUCT SPECIFICATIONS

LIST

PB-FF(-)



Power Band Jumper Cables, Female to Female

- Typically used to connect 2 units together
- For additional lengths in 12" increments, please add \$20 List per foot

MODEL	LENGTH	LIST
PB-FF-30	30"	120
PB-FF-36	36"	120
PB-FF-48	48"	130
PB-FF-54	54"	136
PB-FF-60	60"	141
PB-FF-72	72"	151

PB-FM(-)



Power Band Jumper Cables, Female to Male

- Typically used to connect 2 units together
- For additional lengths in 12" increments, please add \$20 List per foot

MODEL	LENGTH	LIST
PB-FM-30	30"	125
PB-FM-36	36"	125
PB-FM-48	48"	136
PB-FM-54	54"	141
PB-FM-60	60"	146
PB-FM-72	72"	156

PB-T



Power Band T-Connector

- Used when power is needed to go in two directions
- Features 2 male ends and 1 female end

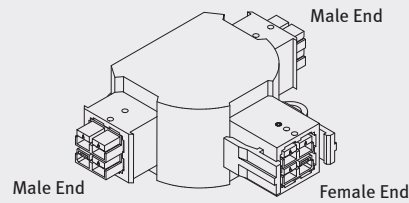

162

FLIRT® MULTI-PURPOSE

designed by 5d studio



SIN #711-11

RECTANGLE TABLE NESTING DIMENSIONS:

*Based on 66" table length

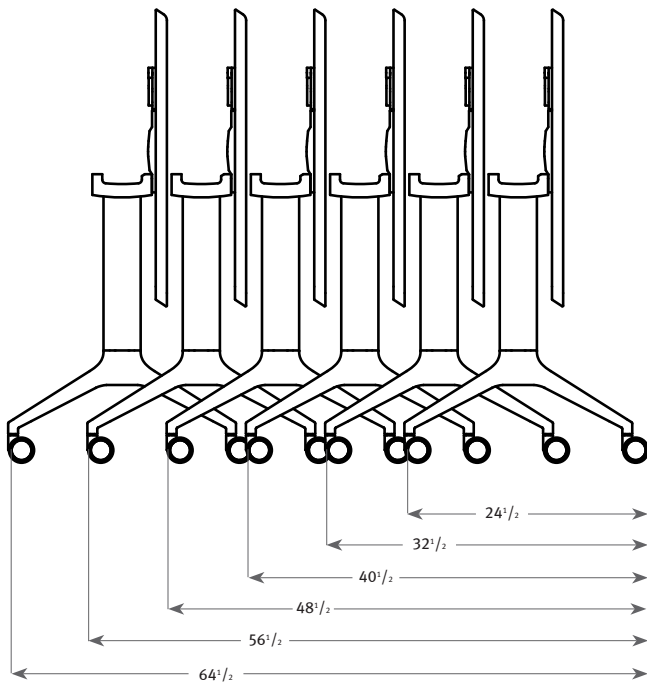
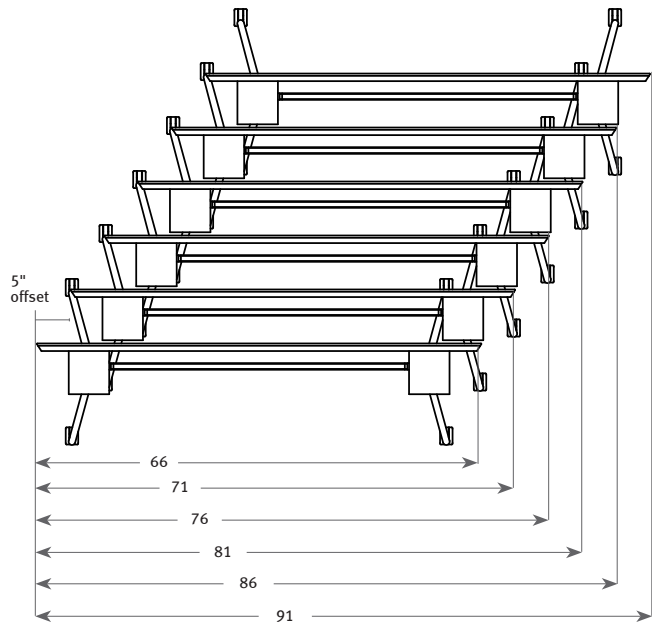
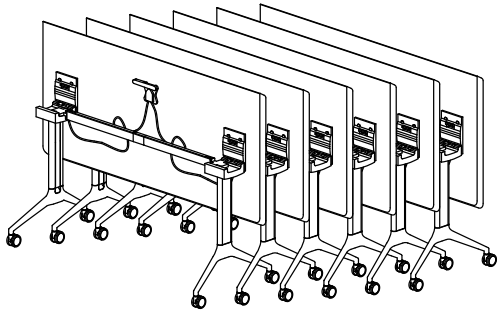

FLIRT® MULTI-PURPOSE

designed by 5d studio



SIN #711-11

ALL OTHER TABLE SHAPES NESTING DIMENSIONS:

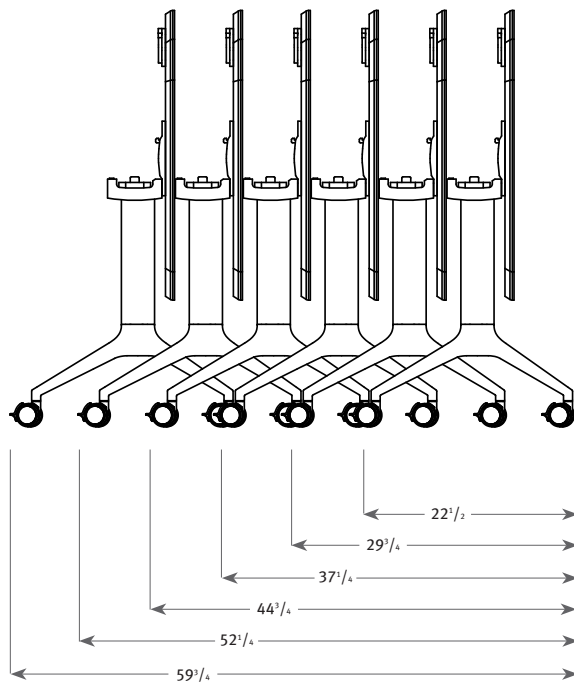
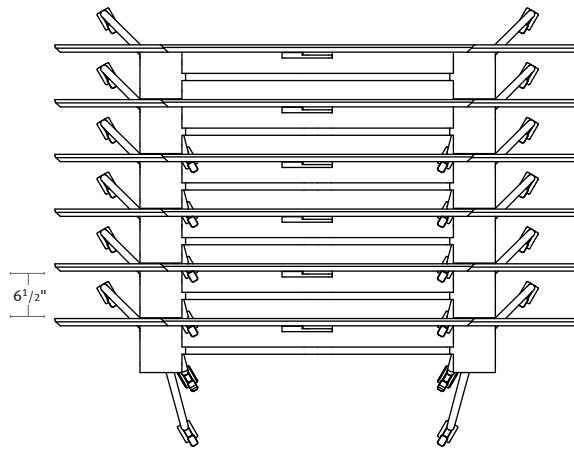
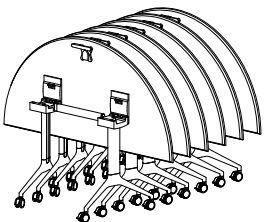
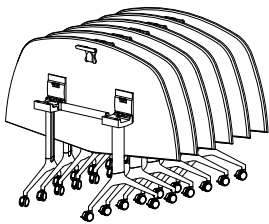
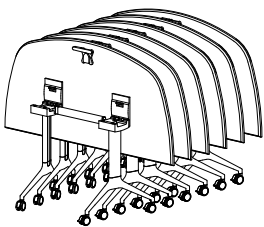
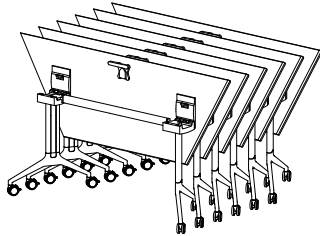
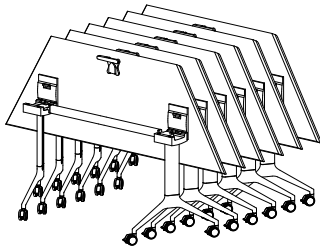

FLIRT® MULTI-PURPOSE

designed by 5d studio



SIN #711-11

CONFIGURATION EXAMPLES:

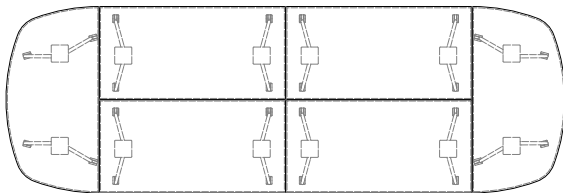

OVERALL DIMENSIONS:
180" x 60"

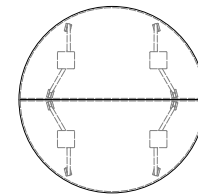

OVERALL DIMENSIONS:
60" x 60"

Qty	Model #	Description	List
4	FX1-306027-BV-EM	Rectangle Fixed Top, Bevel Edge and Edge Mount Base (\$2,395 ea.)	9,580
2	FX5-306027-BV	Radiused End Fixed Top, Bevel Edge and Inset Mount Base (\$2,267 ea.)	4,534
6			14,114

Qty	Model #	Description	List
2	FP4-306029-ES	Half Round Flip-Top Eased Edge (\$2,943 ea.)	5,886

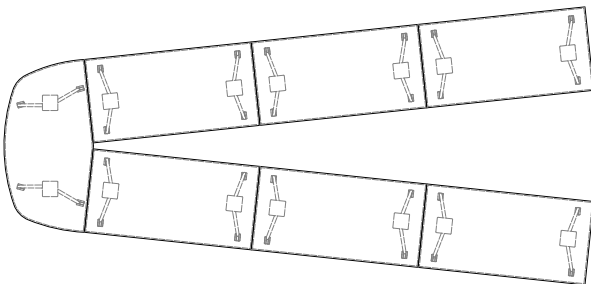

OVERALL DIMENSIONS:
211" x 99"

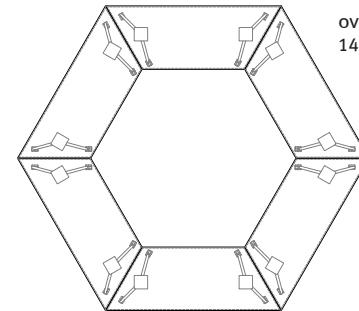

OVERALL DIMENSIONS:
144" x 125"

Qty	Model #	Description	List
6	FP1-306029-WF1-EM	Rectangle Flip-Up Top, Waterfall Edge and Edge Mount Base (\$3,070 ea.)	18,420
2	FP6-326229-BV	Video Conference End, Bevel Edge (\$2,969 ea.)	5,938
8			24,358

Qty	Model #	Description	List
6	FP2-307229-ES-EM	Trapezoid Flip-Top, Long Side, Eased Edge and Edge Mount Base (\$3,190)	19,140

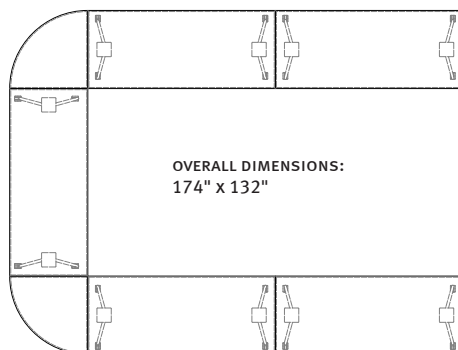

OVERALL DIMENSIONS:
174" x 132"

Qty	Model #	Description	List
5	FX1-307229-ES-EM	Rectangle Fixed Top, Eased Edge and Edge Mount Base (\$2,741 ea.)	13,705
2	FX7-2424-ES	Corner Table, Eased Edge (\$674 ea.)	1,348
8			15,053

FLIRT® MULTI-PURPOSE

designed by 5d studio



SIN #711-11

NOTES:

- Available in Maple, Walnut and White Oak veneer as well as laminate selections.
- Metal base available in standard and premium finishes, refer to page 2 for options.
- **Edge detail and leg placement must be specified with appropriate code added to model number.**
- 78" and 84" length tables include stretcher bar for added stability.
- 48" length tables not available with inset mount base option.
- Refer to page 28 for modesty panel options.

SPECIFY:





1. Model number
2. Wood species
3. Wood finish
4. Edge detail
5. Leg placement
6. Leg finish
7. Options, as applicable

ORDERING EXAMPLE:

#FX1-304827-WF1-IM-PF06

Rectangle Fixed Top Table
30" x 48" x 27"
Waterfall Edge
Inset Mount Leg Placement
Premium Metal Finish

EDGE DETAIL

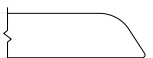
		MODEL NUMBER	EASED (-ES) BEVEL (-BV) OR ONE-SIDED WATERFALL (-WF1)	TWO-SIDED WATERFALL (-WF2)	WEIGHT
<p>FX1 SERIES</p>  <p>Edge Mount Leg Placement</p>  <p>Inset Mount Leg Placement (not available on 48" length)</p> <p>Specify Leg Placement</p> <p>Edge Mount (-EM) Inset Mount (-IM)</p> <p>Specify Edge Style</p>  <p>Eased (-ES)</p>  <p>Beveled (-BV)</p>  <p>Waterfall (-WF1/-WF2)</p>	<p>Rectangle Fixed Top, 27" High Casters</p> <p>24" W x 48" L x 27" H 24" W x 60" L x 27" H 24" W x 66" L x 27" H 24" W x 72" L x 27" H 24" W x 78" L x 27" H 24" W x 84" L x 27" H</p> <p>30" W x 48" L x 27" H 30" W x 60" L x 27" H 30" W x 66" L x 27" H 30" W x 72" L x 27" H 30" W x 78" L x 27" H 30" W x 84" L x 27" H</p> <p>36" W x 48" L x 27" H 36" W x 60" L x 27" H 36" W x 66" L x 27" H 36" W x 72" L x 27" H 36" W x 78" L x 27" H 36" W x 84" L x 27" H</p> <p>42" W x 60" L x 27" H 42" W x 66" L x 27" H 42" W x 72" L x 27" H 42" W x 78" L x 27" H 42" W x 84" L x 27" H</p>	<p>FX1-244827-(-)-() FX1-246027-(-)-() FX1-246627-(-)-() FX1-247227-(-)-() FX1-247827-(-)-() FX1-248427-(-)-() FX1-304827-(-)-() FX1-306027-(-)-() FX1-306627-(-)-() FX1-307227-(-)-() FX1-307827-(-)-() FX1-308427-(-)-() FX1-364827-(-)-() FX1-366027-(-)-() FX1-366627-(-)-() FX1-367227-(-)-() FX1-367827-(-)-() FX1-368427-(-)-() FX1-426027-(-)-() FX1-426627-(-)-() FX1-427227-(-)-() FX1-427827-(-)-() FX1-428427-(-)-()</p>	<p>1708 2247 2302 2356 2740 2783 2155 2515 2671 2826 3586 3640 2256 2618 2775 2932 3693 3748 2700 2859 3017 3779 3835</p>	<p>N/A N/A N/A N/A N/A N/A N/A N/A N/A N/A N/A N/A 2414 2814 2985 3158 3934 4005 2858 3055 3227 4020 4092</p>	<p>46 53 56 59 62 66 53 61 65 69 73 77 61 71 76 81 85 90 80 86 91 97 103</p>

OPTIONS (XXXX - REFERS TO TABLE MODEL NUMBER)

MODEL	DESCRIPTION	LIST
XXXX-GD03	Glides	n/c
XXXX-NS09	Non-Skid Glides	20
XXXX-PF06	Premium Base Finish	220
XXXX-GR01	2" Diameter Grommet, Black	76
XXXX-GR02	2" Diameter Grommet, Chrome	92
GC05 (order separately)	Flirt Ganging Connector (per table joint)	100
XXXX-PB1-S	Power Band 1 (one power, two USB), Silver	413
XXXX-PB1-W	Power Band 1 (one power, two USB), White	413
XXXX-PB2-S	Power Band 2 (dual power), Silver	322
XXXX-PB2-W	Power Band 2 (dual power), White	322
XXXX-PB3-S	Power Band 3 (dual power, two USB), Silver	429
XXXX-PB3-W	Power Band 3 (dual power, two USB), White	429

Please refer to pages 6-8 for daisy chain electrical requirements.

NOTES:

- Available in Maple, Walnut and White Oak veneer as well as laminate selections.
- Metal base available in standard and premium finishes, refer to page 2 for options.
- Edge detail and leg placement must be specified with appropriate code added to model number.**
- 78" and 84" length tables include stretcher bar for added stability.
- 48" length tables not available with inset mount base option.
- Refer to page 28 for modesty panel options.

SPECIFY:

- Model number
- Wood species
- Wood finish
- Edge detail
- Leg placement
- Leg finish
- Options, as applicable

ORDERING EXAMPLE:

#FX1-366029-WF1-IM-PF06

Rectangle Fixed Top Table
36" x 60" x 29"
Waterfall Edge
Inset Mount Leg Placement
Premium Metal Finish





FLIRT®
MULTI-PURPOSE

designed by 5d studio



SIN #711-11

EDGE DETAIL

		MODEL NUMBER	EASED (-ES) BEVEL (-BV) OR ONE-SIDED WATERFALL (-WF1)	TWO-SIDED WATERFALL (-WF2)	WEIGHT
<p>FX1 SERIES</p>  <p>Edge Mount Leg Placement</p>  <p>Inset Mount Leg Placement (not available on 48" length)</p> <p>Specify Leg Placement</p> <p>Edge Mount (-EM) Inset Mount (-IM)</p> <p>Specify Edge Style</p>  <p>Eased (-ES)</p>  <p>Beveled (-BV)</p>  <p>Waterfall (-WF1/-WF2)</p>	<p>Rectangle Fixed Top, 29" High Casters</p> <p>24" W x 48" L x 29" H 24" W x 60" L x 29" H 24" W x 66" L x 29" H 24" W x 72" L x 29" H 24" W x 78" L x 29" H 24" W x 84" L x 29" H</p> <p>30" W x 48" L x 29" H 30" W x 60" L x 29" H 30" W x 66" L x 29" H 30" W x 72" L x 29" H 30" W x 78" L x 29" H 30" W x 84" L x 29" H</p> <p>36" W x 48" L x 29" H 36" W x 60" L x 29" H 36" W x 66" L x 29" H 36" W x 72" L x 29" H 36" W x 78" L x 29" H 36" W x 84" L x 29" H</p> <p>42" W x 60" L x 29" H 42" W x 66" L x 29" H 42" W x 72" L x 29" H 42" W x 78" L x 29" H 42" W x 84" L x 29" H</p>	<p>FX1-244829-()-() FX1-246029-()-() FX1-246629-()-() FX1-247229-()-() FX1-247829-()-() FX1-248429-()-() FX1-304829-()-() FX1-306029-()-() FX1-306629-()-() FX1-307229-()-() FX1-307829-()-() FX1-308429-()-() FX1-364829-()-() FX1-366029-()-() FX1-366629-()-() FX1-367229-()-() FX1-367829-()-() FX1-368429-()-() FX1-426029-()-() FX1-426629-()-() FX1-427229-()-() FX1-427829-()-() FX1-428429-()-()</p>	<p>1760 2300 2355 2408 2792 2835 2208 2567 2723 2879 3639 3692 2308 2671 2827 2985 3746 3800 2753 2911 3070 3832 3888</p>	<p>N/A N/A N/A N/A N/A N/A N/A N/A N/A N/A N/A N/A 2624 3063 3247 3437 4228 4314 3069 3303 3490 4284 4370</p>	<p>48 55 58 61 64 68 55 63 67 71 75 79 63 73 78 83 87 92 82 88 93 99 105</p>

OPTIONS (XXXX - REFERS TO TABLE MODEL NUMBER)

MODEL	DESCRIPTION	LIST
XXXX-GD03	Glides	n/c
XXXX-NS09	Non-Skid Glides	20
XXXX-PF06	Premium Base Finish	220
XXXX-GR01	2" Diameter Grommet, Black	76
XXXX-GR02	2" Diameter Grommet, Chrome	92
GC05 (order separately)	Flirt Ganging Connector (per table joint)	100
XXXX-PB1-S	Power Band 1 (one power, two USB), Silver	413
XXXX-PB1-W	Power Band 1 (one power, two USB), White	413
XXXX-PB2-S	Power Band 2 (dual power), Silver	322
XXXX-PB2-W	Power Band 2 (dual power), White	322
XXXX-PB3-S	Power Band 3 (dual power, two USB), Silver	429
XXXX-PB3-W	Power Band 3 (dual power, two USB), White	429

Please refer to pages 6-8 for daisy chain electrical requirements.

FLIRT® MULTI-PURPOSE

designed by 5d studio



SIN #711-11

NOTES:

- Available in Maple, Walnut and White Oak veneer as well as laminate selections.
- Metal base available in standard and premium finishes, refer to page 2 for options.
- **Edge detail and leg placement must be specified with appropriate code added to model number.**
- 42" high tables feature stretcher bar for added stability. Stretcher bar will match leg finish as standard, unless otherwise specified.
- Refer to page 28 for modesty panel options.

SPECIFY:





1. Model number
2. Wood species
3. Wood finish
4. Edge detail
5. Leg placement
6. Leg finish
7. Options, as applicable

ORDERING EXAMPLE:

#FX1-308442-WF1-IM-PF06

 Rectangle Fixed Top Table
 30" x 84" x 42"
 Waterfall Edge
 Inset Mount Leg Placement
 Premium Metal Finish

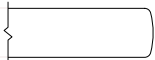
EDGE DETAIL

		MODEL NUMBER	EASED (-ES) BEVEL (-BV) OR ONE-SIDED WATERFALL (-WF1)	TWO-SIDED WATERFALL (-WF2)	WEIGHT		
FX1 SERIES	 Edge Mount Leg Placement	Rectangle Fixed Top, 42" High Casters					
		24" W x 60" L x 42" H	FX1-246042-()-()	2921	N/A	61	
		24" W x 72" L x 42" H	FX1-247242-()-()	3014	N/A	67	
	24" W x 84" L x 42" H	FX1-248442-()-()	3179	N/A	74		
	 Inset Mount Leg Placement	30" W x 60" L x 42" H	FX1-306042-()-()	3188	N/A	69	
		30" W x 72" L x 42" H	FX1-307242-()-()	3484	N/A	77	
		30" W x 84" L x 42" H	FX1-308442-()-()	4035	N/A	85	
	Specify Leg Placement Edge Mount (-EM) Inset Mount (-IM)	36" W x 60" L x 42" H	FX1-366042-()-()	3292	3684	82	
		36" W x 72" L x 42" H	FX1-367242-()-()	3590	4042	92	
		36" W x 84" L x 42" H	FX1-368442-()-()	4143	4657	101	
	Specify Edge Style	 Eased (-ES)	42" W x 60" L x 42" H	FX1-426042-()-()	3374	3766	91
			42" W x 72" L x 42" H	FX1-427242-()-()	3675	4127	102
42" W x 84" L x 42" H			FX1-428442-()-()	4230	4744	114	
 Beveled (-BV)							
	 Waterfall (-WF1/-WF2)						

OPTIONS (XXXX - REFERS TO TABLE MODEL NUMBER)

MODEL	DESCRIPTION	LIST
XXXX-GD03	Glides	n/c
XXXX-NS09	Non-Skid Glides	20
XXXX-PF06	Premium Base Finish	220
XXXX-GR01	2" Diameter Grommet, Black	76
XXXX-GR02	2" Diameter Grommet, Chrome	92
GC05 (order separately)	Flirt Ganging Connector (per table joint)	100
XXXX-PB1-S	Power Band 1 (one power, two USB), Silver	413
XXXX-PB1-W	Power Band 1 (one power, two USB), White	413
XXXX-PB2-S	Power Band 2 (dual power), Silver	322
XXXX-PB2-W	Power Band 2 (dual power), White	322
XXXX-PB3-S	Power Band 3 (dual power, two USB), Silver	429
XXXX-PB3-W	Power Band 3 (dual power, two USB), White	429

NOTES:

- Available in Maple, Walnut and White Oak veneer as well as laminate selections.
- Metal base available in standard and premium finishes, refer to page 2 for options.
- Edge detail and leg placement must be specified with appropriate code added to model number.**
- 48" length tables not available with inset mount base option.
- Refer to page 28 for modesty panel options.

SPECIFY:

- Model number
- Wood species
- Wood finish
- Edge detail
- Leg placement
- Leg finish
- Options, as applicable

ORDERING EXAMPLE:

#FP1-304827-ES-EM-PF06
 Rectangle Flip-Up Top Table
 30" x 48" x 27"
 Eased Edge
 Edge Mount Leg Placement
 Premium Metal Finish

FLIRT®
MULTI-PURPOSE

designed by 5d studio



SIN #711-11

EDGE DETAIL

		MODEL NUMBER	EASED (-ES) BEVEL (-BV) OR ONE-SIDED WATERFALL (-WF1)	TWO-SIDED WATERFALL (-WF2)	WEIGHT		
FP1 SERIES	Rectangle Flip-Up Top, 27" High Casters	24" W x 48" L x 27" H	FP1-244827-(-)(-)	2452	N/A	49	
		24" W x 60" L x 27" H	FP1-246027-(-)(-)	2904	N/A	56	
		24" W x 66" L x 27" H	FP1-246627-(-)(-)	2988	N/A	59	
		24" W x 72" L x 27" H	FP1-247227-(-)(-)	3041	N/A	62	
		24" W x 78" L x 27" H	FP1-247827-(-)(-)	3483	N/A	65	
		24" W x 84" L x 27" H	FP1-248427-(-)(-)	3527	N/A	69	
	Edge Mount Leg Placement		30" W x 48" L x 27" H	FP1-304827-(-)(-)	2901	N/A	56
			30" W x 60" L x 27" H	FP1-306027-(-)(-)	3171	N/A	64
			30" W x 66" L x 27" H	FP1-306627-(-)(-)	3356	N/A	68
			30" W x 72" L x 27" H	FP1-307227-(-)(-)	3512	N/A	72
			30" W x 78" L x 27" H	FP1-307827-(-)(-)	4330	N/A	76
			30" W x 84" L x 27" H	FP1-308427-(-)(-)	4383	N/A	80
Inset Mount Leg Placement (not available on 48" length)		36" W x 48" L x 27" H	FP1-364827-(-)(-)	3000	3158	64	
		36" W x 60" L x 27" H	FP1-366027-(-)(-)	3274	3470	74	
		36" W x 66" L x 27" H	FP1-366627-(-)(-)	3460	3670	79	
		36" W x 72" L x 27" H	FP1-367227-(-)(-)	3618	3844	84	
		36" W x 78" L x 27" H	FP1-367827-(-)(-)	4437	4678	88	
		36" W x 84" L x 27" H	FP1-368427-(-)(-)	4491	4748	93	
Specify Leg Placement							
Edge Mount (-EM)							
Inset Mount (-IM)							
Specify Edge Style							
Eased (-ES)							
Beveled (-BV)							
Waterfall (-WF1/-WF2)							

OPTIONS (XXXX - REFERS TO TABLE MODEL NUMBER)

MODEL	DESCRIPTION	LIST
XXXX-GD03	Glides	n/c
XXXX-NS09	Non-Skid Glides	20
XXXX-PF06	Premium Base Finish	220
XXXX-GR01	2" Diameter Grommet, Black	76
XXXX-GR02	2" Diameter Grommet, Chrome	92
GC05 (order separately)	Flirt Ganging Connector (per table joint)	100
XXXX-PB1-S	Power Band 1 (one power, two USB), Silver	413
XXXX-PB1-W	Power Band 1 (one power, two USB), White	413
XXXX-PB2-S	Power Band 2 (dual power), Silver	322
XXXX-PB2-W	Power Band 2 (dual power), White	322
XXXX-PB3-S	Power Band 3 (dual power, two USB), Silver	429
XXXX-PB3-W	Power Band 3 (dual power, two USB), White	429

Please refer to pages 6-8 for daisy chain electrical requirements.

FLIRT® MULTI-PURPOSE

designed by 5d studio



SIN #711-11

NOTES:

- Available in Maple, Walnut and White Oak veneer as well as laminate selections.
- Metal base available in standard and premium finishes, refer to page 2 for options.
- **Edge detail and leg placement must be specified with appropriate code added to model number.**
- 48" length tables not available with inset mount base option.
- Refer to page 28 for modesty panel options.

SPECIFY:

1. Model number
2. Wood species
3. Wood finish
4. Edge detail
5. Leg placement
6. Leg finish
7. Options, as applicable

ORDERING EXAMPLE:

#FP1-366629-WF2-IM-PF06

 Rectangle Flip-Up Top Table
 36" x 66" x 29"
 Waterfall Edge, Two-Sided
 Inset Mount Leg Placement
 Premium Metal Finish

EDGE DETAIL

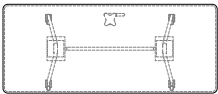
		MODEL NUMBER	EASED (-ES) BEVEL (-BV) OR ONE-SIDED WATERFALL (-WF1)	TWO-SIDED WATERFALL (-WF2)	WEIGHT	
FP1 SERIES	 Edge Mount Leg Placement	Rectangle Flip-Up Top, 29" High Casters				
		24" W x 48" L x 29" H	FP1-244829-()-()	2505	N/A	51
		24" W x 60" L x 29" H	FP1-246029-()-()	2956	N/A	58
		24" W x 66" L x 29" H	FP1-246629-()-()	3040	N/A	61
		24" W x 72" L x 29" H	FP1-247229-()-()	3094	N/A	64
		24" W x 78" L x 29" H	FP1-247829-()-()	3536	N/A	67
	 Inset Mount Leg Placement (not available on 48" length)	24" W x 84" L x 29" H	FP1-248429-()-()	3580	N/A	71
		30" W x 48" L x 29" H	FP1-304829-()-()	2953	N/A	58
		30" W x 60" L x 29" H	FP1-306029-()-()	3224	N/A	66
		30" W x 66" L x 29" H	FP1-306629-()-()	3409	N/A	70
		30" W x 72" L x 29" H	FP1-307229-()-()	3564	N/A	74
		30" W x 78" L x 29" H	FP1-307829-()-()	4382	N/A	79
	Specify Leg Placement	30" W x 84" L x 29" H	FP1-308429-()-()	4436	N/A	82
		Edge Mount (-EM)	FP1-364829-()-()	3053	3211	66
	Specify Edge Style	Inset Mount (-IM)	FP1-366029-()-()	3327	3523	76
		Edge Mount (-EM)	FP1-366629-()-()	3513	3723	81
		Inset Mount (-IM)	FP1-367229-()-()	3670	3896	86
		Eased (-ES)	FP1-367829-()-()	4489	4730	90
		Beveled (-BV)	FP1-368429-()-()	4544	4801	95
		Waterfall (-WF1/-WF2)				

OPTIONS (XXXX - REFERS TO TABLE MODEL NUMBER)

MODEL	DESCRIPTION	LIST
XXXX-GD03	Glides	n/c
XXXX-NS09	Non-Skid Glides	20
XXXX-PF06	Premium Base Finish	220
XXXX-GR01	2" Diameter Grommet, Black	76
XXXX-GR02	2" Diameter Grommet, Chrome	92
GC05 (order separately)	Flirt Ganging Connector (per table joint)	100
XXXX-PB1-S	Power Band 1 (one power, two USB), Silver	413
XXXX-PB1-W	Power Band 1 (one power, two USB), White	413
XXXX-PB2-S	Power Band 2 (dual power), Silver	322
XXXX-PB2-W	Power Band 2 (dual power), White	322
XXXX-PB3-S	Power Band 3 (dual power, two USB), Silver	429
XXXX-PB3-W	Power Band 3 (dual power, two USB), White	429

Please refer to pages 6-8 for daisy chain electrical requirements.

NOTES:

- Available in Maple, Walnut and White Oak veneer as well as laminate selections.
- Metal base available in standard and premium finishes, refer to page 2 for options.
- Waterfall edge presented on leading edge (long side) only with remaining three sides featuring beveled edge detail.
- **Edge detail must be specified with appropriate code added to model number.**
- Refer to page 29 for modesty panel options.

SPECIFY:

1. Model number
2. Wood species
3. Wood finish
4. Edge detail
5. Leg finish
6. Options, as applicable

ORDERING EXAMPLE:

#FX2-266027-ES-EM-PB1-S
 26 x 60 x 27 Trapezoid Fixed
 Top Table, Long Side
 Eased Edge
 Edge Mount Leg Placement
 Power Band 1 Unit, Silver

FLIRT®
MULTI-PURPOSE

designed by 5d studio



SIN #711-11

		MODEL NUMBER	LIST	WEIGHT
FX2 SERIES Trapezoid Fixed Top, Long Side 27" High, Casters Edge Mount Leg Placement Only	21" W x 48" L x 27" H	FX2-244827-()-EM	1652	38
	21" W x 60" L x 27" H	FX2-246027-()-EM	2183	44
	26" W x 60" L x 27" H	FX2-306027-()-EM	2209	48
	26" W x 72" L x 27" H	FX2-307227-()-EM	2642	54
Specify Edge Style Trapezoid Fixed Top, Long Side 29" High, Casters Edge Mount Leg Placement Only	21" W x 48" L x 29" H	FX2-244829-()-EM	1705	40
	21" W x 60" L x 29" H	FX2-246029-()-EM	2236	46
	26" W x 60" L x 29" H	FX2-306029-()-EM	2261	50
	26" W x 72" L x 29" H	FX2-307229-()-EM	2695	56

OPTIONS (XXXX - REFERS TO TABLE MODEL NUMBER)

MODEL	DESCRIPTION	LIST
XXXX-GD03	Glides	n/c
XXXX-NS09	Non-Skid Glides	20
XXXX-PF06	Premium Base Finish	220
XXXX-GR01	2" Diameter Grommet, Black	76
XXXX-GR02	2" Diameter Grommet, Chrome	92
GC05 (order separately)	Flirt Ganging Connector (per table joint)	100
XXXX-PB1-S	Power Band 1 (one power, two USB), Silver	413
XXXX-PB1-W	Power Band 1 (one power, two USB), White	413
XXXX-PB2-S	Power Band 2 (dual power), Silver	322
XXXX-PB2-W	Power Band 2 (dual power), White	322
XXXX-PB3-S	Power Band 3 (dual power, two USB), Silver	429
XXXX-PB3-W	Power Band 3 (dual power, two USB), White	429

Please refer to pages 6-8 for daisy chain electrical requirements.

FLIRT® MULTI-PURPOSE

designed by 5d studio



NOTES:

- Available in Maple, Walnut and White Oak veneer as well as laminate selections.
- Metal base available in standard and premium finishes, refer to page 2 for options.
- Waterfall edge presented on leading edge (long side) only with remaining three sides featuring beveled edge detail.
- **Edge detail must be specified with appropriate code added to model number.**
- Refer to page 29 for modesty panel options.

SPECIFY:

1. Model number
2. Wood species
3. Wood finish
4. Edge detail
5. Leg finish
6. Options, as applicable

ORDERING EXAMPLE:

#FP2-266027-WF1-EM-PB1-W

26 x 60 x 27 Trapezoid Flip-Up
Top Table, Long Side
Waterfall Edge
Edge Mount Leg Placement
Power Band 1 Unit, White

SIN #711-11

		MODEL NUMBER	LIST	WEIGHT
<p>FP2 SERIES</p> <p>Leading Edge</p> <p>Edge Mount Leg Placement</p>	<p>Trapezoid Flip-Up Top, Long Side 27" High, Casters Edge Mount Leg Placement Only</p> <p>21" W x 48" L x 27" H 21" W x 60" L x 27" H 26" W x 60" L x 27" H 26" W x 72" L x 27" H</p>	<p>FP2-244827(-)-EM FP2-246027(-)-EM FP2-306027(-)-EM FP2-307227(-)-EM</p>	<p>2397 2839 2865 3297</p>	<p>40 46 50 56</p>
	<p>Trapezoid Flip-Up Top, Long Side 29" High, Casters Edge Mount Leg Placement Only</p> <p>21" W x 48" L x 29" H 21" W x 60" L x 29" H 26" W x 60" L x 29" H 26" W x 72" L x 29" H</p>	<p>FP2-244829(-)-EM FP2-246029(-)-EM FP2-306029(-)-EM FP2-307229(-)-EM</p>	<p>2449 2891 2917 3350</p>	<p>42 48 52 58</p>

Specify Edge Style



Eased (-ES)



Beveled (-BV)



Waterfall (-WF1)

OPTIONS (XXXX - REFERS TO TABLE MODEL NUMBER)

MODEL	DESCRIPTION	LIST
XXXX-GD03	Glides	n/c
XXXX-NS09	Non-Skid Glides	20
XXXX-PF06	Premium Base Finish	220
XXXX-GR01	2" Diameter Grommet, Black	76
XXXX-GR02	2" Diameter Grommet, Chrome	92
GC05 (order separately)	Flirt Ganging Connector (per table joint)	100
XXXX-PB1-S	Power Band 1 (one power, two USB), Silver	413
XXXX-PB1-W	Power Band 1 (one power, two USB), White	413
XXXX-PB2-S	Power Band 2 (dual power), Silver	322
XXXX-PB2-W	Power Band 2 (dual power), White	322
XXXX-PB3-S	Power Band 3 (dual power, two USB), Silver	429
XXXX-PB3-W	Power Band 3 (dual power, two USB), White	429

Please refer to pages 6-8 for daisy chain electrical requirements.

NOTES:

- Available in Maple, Walnut and White Oak veneer as well as laminate selections.
- Metal base available in standard and premium finishes, refer to page 1 for options.
- Waterfall edge presented on leading edge (short side) only with remaining three sides featuring beveled edge detail.
- **Edge detail must be specified with appropriate code added to model number.**
- Refer to page 29 for modesty panel options.

SPECIFY:

1. Model number
2. Wood species
3. Wood finish
4. Edge detail
5. Leg finish
6. Options, as applicable

ORDERING EXAMPLE:

#FX3-266027-ES-PB1-S

21 x 60 x 29 Trapezoid Fixed
Top Table, Short Side
Eased Edge
Edge Mount Leg Placement
Power Band 1 Unit, Silver

FLIRT®
MULTI-PURPOSE

designed by 5d studio



SIN #711-11

		MODEL NUMBER	LIST	WEIGHT
FX3 SERIES Edge Mount Leg Placement	Trapezoid Fixed Top, Short Side 27" High, Casters Edge Mount Leg Placement Only	FX3-244827(-)-EM	1652	38
	21" W x 48" L x 27" H	FX3-246027(-)-EM	2183	44
	21" W x 60" L x 27" H	FX3-306027(-)-EM	2209	48
	26" W x 60" L x 27" H	FX3-307227(-)-EM	2642	54
	26" W x 72" L x 27" H			
	Trapezoid Fixed Top, Short Side 29" High, Casters Edge Mount Leg Placement Only	FX3-244829(-)-EM	1705	40
	21" W x 48" L x 29" H	FX3-246029(-)-EM	2236	46
	21" W x 60" L x 29" H	FX3-306029(-)-EM	2261	50
	26" W x 60" L x 29" H	FX3-307229(-)-EM	2695	56
	26" W x 72" L x 29" H			
Specify Edge Style Eased (-ES) Beveled (-BV) Waterfall (-WF1)				

OPTIONS (XXXX - REFERS TO TABLE MODEL NUMBER)

MODEL	DESCRIPTION	LIST
XXXX-GD03	Glides	n/c
XXXX-NS09	Non-Skid Glides	20
XXXX-PF06	Premium Base Finish	220
XXXX-GR01	2" Diameter Grommet, Black	76
XXXX-GR02	2" Diameter Grommet, Chrome	92
GC05 (order separately)	Flirt Ganging Connector (per table joint)	100
XXXX-PB1-S	Power Band 1 (one power, two USB), Silver	413
XXXX-PB1-W	Power Band 1 (one power, two USB), White	413
XXXX-PB2-S	Power Band 2 (dual power), Silver	322
XXXX-PB2-W	Power Band 2 (dual power), White	322
XXXX-PB3-S	Power Band 3 (dual power, two USB), Silver	429
XXXX-PB3-W	Power Band 3 (dual power, two USB), White	429

Please refer to pages 6-8 for daisy chain electrical requirements.

FLIRT® MULTI-PURPOSE

designed by 5d studio



NOTES:

- Available in Maple, Walnut and White Oak veneer as well as laminate selections.
- Metal base available in standard and premium finishes, refer to page 2 for options.
- Waterfall edge presented on leading edge (short side) only with remaining three sides featuring beveled edge detail.
- **Edge detail must be specified with appropriate code added to model number.**
- Refer to page 29 for modesty panel options.

SPECIFY:

1. Model number
2. Wood species
3. Wood finish
4. Edge detail
5. Leg finish
6. Options, as applicable

ORDERING EXAMPLE:

#FP3-267227-WF1-EM-PF06

26 x 72 x 27 Trapezoid Flip-Up
Top Table, Short Side
Waterfall Edge
Edge Mount Leg Placement
Premium Metal Finish

SIN #711-11

		MODEL NUMBER	LIST	WEIGHT
<p>FP3 SERIES</p>	<p>Trapezoid Flip-Up Top, Short Side 27" High, Casters Edge Mount Leg Placement Only</p> <p>21" W x 48" L x 27" H 21" W x 60" L x 27" H 26" W x 60" L x 27" H 26" W x 72" L x 27" H</p>	<p>FP3-244827-()-EM FP3-246027-()-EM FP3-306027-()-EM FP3-307227-()-EM</p>	<p>2397 2839 2865 3297</p>	<p>40 46 50 56</p>
	<p>Trapezoid Flip-Up Top, Short Side 29" High, Casters Edge Mount Leg Placement Only</p> <p>21" W x 48" L x 29" H 21" W x 60" L x 29" H 26" W x 60" L x 29" H 26" W x 72" L x 29" H</p>	<p>FP3-244829-()-EM FP3-246029-()-EM FP3-306029-()-EM FP3-307229-()-EM</p>	<p>2449 2891 2917 3350</p>	<p>42 48 52 58</p>

Specify Edge Style

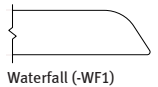
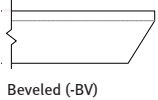

OPTIONS (XXXX - REFERS TO TABLE MODEL NUMBER)

MODEL	DESCRIPTION	LIST
XXXX-GD03	Glides	n/c
XXXX-NS09	Non-Skid Glides	20
XXXX-PF06	Premium Base Finish	220
XXXX-GR01	2" Diameter Grommet, Black	76
XXXX-GR02	2" Diameter Grommet, Chrome	92
GC05 (order separately)	Flirt Ganging Connector (per table joint)	100
XXXX-PB1-S	Power Band 1 (one power, two USB), Silver	413
XXXX-PB1-W	Power Band 1 (one power, two USB), White	413
XXXX-PB2-S	Power Band 2 (dual power), Silver	322
XXXX-PB2-W	Power Band 2 (dual power), White	322
XXXX-PB3-S	Power Band 3 (dual power, two USB), Silver	429
XXXX-PB3-W	Power Band 3 (dual power, two USB), White	429

Please refer to pages 6-8 for daisy chain electrical requirements.

NOTES:

- Available in Maple, Walnut and White Oak veneer as well as laminate selections.
- Metal base available in standard and premium finishes, refer to page 2 for options.

SPECIFY:

- Model number
- Wood species
- Wood finish
- Edge detail
- Leg finish
- Options, as applicable

ORDERING EXAMPLE:



#FX4-306029-BV-IM-GD02
 30 x 60 x 29 Half Round Table
 Beveled Edge
 Inset Leg Placement
 Glides

FLIRT®
MULTI-PURPOSE

designed by 5d studio

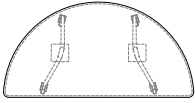

SIN #711-11

		MODEL NUMBER	LIST	WEIGHT
FX4 SERIES  Inset Mount Leg Placement	Half-Round Fixed Top 27" High, Casters Inset Leg Placement Only Eased Edge Detail 24" W x 48" L x 27" H 30" W x 60" L x 27" H 36" W x 72" L x 27" H	FX4-244827-ES-IM	1977	41
		FX4-306027-ES-IM	2362	51
		FX4-367227-ES-IM	2746	68
	Beveled Edge Detail 24" W x 48" L x 27" H 30" W x 60" L x 27" H 36" W x 72" L x 27" H	FX4-244827-BV-IM	1977	41
		FX4-306027-BV-IM	2362	52
		FX4-367227-BV-IM	2746	68
Edge Styles  Eased (-ES)  Beveled (-BV)	Half-Round Fixed Top 29" High, Casters Inset Leg Placement Only Eased Edge Detail 24" W x 48" L x 29" H 30" W x 60" L x 29" H 36" W x 72" L x 29" H	FX4-244829-ES-IM	2029	43
		FX4-306029-ES-IM	2414	54
		FX4-367229-ES-IM	2799	70
	Beveled Edge Detail 24" W x 48" L x 29" H 30" W x 60" L x 29" H 36" W x 72" L x 29" H	FX4-244829-BV-IM	2029	43
		FX4-306029-BV-IM	2414	54
		FX4-367229-BV-IM	2799	70

OPTIONS (XXXX - REFERS TO TABLE MODEL NUMBER)

MODEL	DESCRIPTION	LIST
XXXX-GD03	Glides	n/c
XXXX-NS09	Non-Skid Glides	20
XXXX-PF06	Premium Base Finish	220
XXXX-GR01	2" Diameter Grommet, Black	76
XXXX-GR02	2" Diameter Grommet, Chrome	92
GC05 (order separately)	Flirt Ganging Connector (per table joint)	100
XXXX-PB1-S	Power Band 1 (one power, two USB), Silver	413
XXXX-PB1-W	Power Band 1 (one power, two USB), White	413
XXXX-PB2-S	Power Band 2 (dual power), Silver	322
XXXX-PB2-W	Power Band 2 (dual power), White	322
XXXX-PB3-S	Power Band 3 (dual power, two USB), Silver	429
XXXX-PB3-W	Power Band 3 (dual power, two USB), White	429

Please refer to pages 6-8 for daisy chain electrical requirements.

FLIRT® MULTI-PURPOSE

designed by 5d studio



SIN #711-11

NOTES:

- Available in Maple, Walnut and White Oak veneer as well as laminate selections.
- Metal base available in standard and premium finishes, refer to page 2 for options.

SPECIFY:

1. Model number
2. Wood species
3. Wood finish
4. Edge detail
5. Leg finish
6. Options, as applicable

ORDERING EXAMPLE:

#FP4-244827-ES-IM-PF06

24 x 48 x 27 Half-Round Flip-Up
Top Table
Eased Edge
Inset Leg Placement
Premium Metal Finish

		MODEL NUMBER	LIST	WEIGHT
<p>FP4 SERIES</p> <p>Inset Mount Leg Placement</p> <p>Edge Styles</p> <p>Eased (-ES)</p> <p>Beveled (-BV)</p>	<p>Half-Round Flip-Up Top 27" High, Casters Inset Leg Placement Only</p> <p>Eased Edge Detail 24" W x 48" L x 27" H 30" W x 60" L x 27" H 36" W x 72" L x 27" H</p> <p>Beveled Edge Detail 24" W x 48" L x 27" H 30" W x 60" L x 27" H 36" W x 72" L x 27" H</p>	<p>FP4-244827-ES-IM FP4-306027-ES-IM FP4-367227-ES-IM</p> <p>FP4-244827-BV-IM FP4-306027-BV-IM FP4-367227-BV-IM</p>	<p>2721 3038 3401</p> <p>2721 3038 3401</p>	<p>44 55 71</p> <p>44 55 71</p>
	<p>Half-Round Flip-Up Top 29" High, Casters Inset Leg Placement Only</p> <p>Eased Edge Detail 24" W x 48" L x 29" H 30" W x 60" L x 29" H 36" W x 72" L x 29" H</p> <p>Beveled Edge Detail 24" W x 48" L x 29" H 30" W x 60" L x 29" H 36" W x 72" L x 29" H</p>	<p>FP4-244829-ES-IM FP4-306029-ES-IM FP4-367229-ES-IM</p> <p>FP4-244829-BV-IM FP4-306029-BV-IM FP4-367229-BV-IM</p>	<p>2774 3091 3454</p> <p>2774 3091 3454</p>	<p>46 57 73</p> <p>46 57 73</p>

OPTIONS (XXXX - REFERS TO TABLE MODEL NUMBER)

MODEL	DESCRIPTION	LIST
XXXX-GD03	Glides	n/c
XXXX-NS09	Non-Skid Glides	20
XXXX-PF06	Premium Base Finish	220
XXXX-GR01	2" Diameter Grommet, Black	76
XXXX-GR02	2" Diameter Grommet, Chrome	92
GC05 (order separately)	Flirt Ganging Connector (per table joint)	100
XXXX-PB1-S	Power Band 1 (one power, two USB), Silver	413
XXXX-PB1-W	Power Band 1 (one power, two USB), White	413
XXXX-PB2-S	Power Band 2 (dual power), Silver	322
XXXX-PB2-W	Power Band 2 (dual power), White	322
XXXX-PB3-S	Power Band 3 (dual power, two USB), Silver	429
XXXX-PB3-W	Power Band 3 (dual power, two USB), White	429

Please refer to pages 6-8 for daisy chain electrical requirements.

NOTES:

- Available in Maple, Walnut and White Oak veneer as well as laminate selections.
- Metal base available in standard and premium finishes, refer to page 2 for options.

SPECIFY:

- Model number
- Wood species
- Wood finish
- Edge detail
- Leg finish
- Options, as applicable

ORDERING EXAMPLE:



#FX5-306027-BV-IM-GD02
 30 x 60 x 27 Radiused End
 Fixed Top Table
 Beveled Edge
 Inset Leg Placement
 Glides

FLIRT®
MULTI-PURPOSE

designed by 5d studio

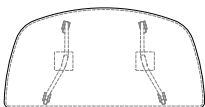
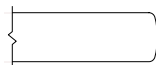

SIN #711-11

		MODEL NUMBER	LIST	WEIGHT
FX5 SERIES  Inset Mount Leg Placement	Radiused End Connecting Table Fixed Top, 27" High, Casters Inset Leg Placement Only Eased Edge Detail 24" W x 48" L x 27" H 30" W x 60" L x 27" H 36" W x 72" L x 27" H Beveled Edge Detail 24" W x 48" L x 27" H 30" W x 60" L x 27" H 36" W x 72" L x 27" H	FX5-244827-ES-IM	1981	46
		FX5-306027-ES-IM	2381	59
		FX5-367227-ES-IM	2795	75
		FX5-244827-BV-IM	1981	46
		FX5-306027-BV-IM	2381	59
		FX5-367227-BV-IM	2795	75
Edge Styles  Eased (-ES)  Beveled (-BV)	Radiused End Connecting Table Fixed Top, 29" High, Casters Inset Leg Placement Only Eased Edge Detail 24" W x 48" L x 29" H 30" W x 60" L x 29" H 36" W x 72" L x 29" H Beveled Edge Detail 24" W x 48" L x 29" H 30" W x 60" L x 29" H 36" W x 72" L x 29" H	FX5-244829-ES-IM	2033	48
		FX5-306029-ES-IM	2433	61
		FX5-367229-ES-IM	2847	77
		FX5-244829-BV-IM	2033	48
		FX5-306029-BV-IM	2433	61
		FX5-367229-BV-IM	2847	77

OPTIONS (XXXX - REFERS TO TABLE MODEL NUMBER)

MODEL	DESCRIPTION	LIST
XXXX-GD03	Glides	n/c
XXXX-NS09	Non-Skid Glides	20
XXXX-PF06	Premium Base Finish	220
XXXX-GR01	2" Diameter Grommet, Black	76
XXXX-GR02	2" Diameter Grommet, Chrome	92
GC05 (order separately)	Flirt Ganging Connector (per table joint)	100
XXXX-PB1-S	Power Band 1 (one power, two USB), Silver	413
XXXX-PB1-W	Power Band 1 (one power, two USB), White	413
XXXX-PB2-S	Power Band 2 (dual power), Silver	322
XXXX-PB2-W	Power Band 2 (dual power), White	322
XXXX-PB3-S	Power Band 3 (dual power, two USB), Silver	429
XXXX-PB3-W	Power Band 3 (dual power, two USB), White	429

Please refer to pages 6-8 for daisy chain electrical requirements.

FLIRT® MULTI-PURPOSE

designed by 5d studio



SIN #711-11

NOTES:

- Available in Maple, Walnut and White Oak veneer as well as laminate selections.
- Metal base available in standard and premium finishes, refer to page 2 for options.

SPECIFY:

- Model number
- Wood species
- Wood finish
- Edge detail
- Leg finish
- Options, as applicable

ORDERING EXAMPLE:

#FP5-367227-ES-IM-PF06
36" x 72" x 27" Radiused End,
Flip-Up Top
Eased Edge
Inset Leg Placement
Premium Metal Finish

		MODEL NUMBER	LIST	WEIGHT
<p>FP5 SERIES</p> <p>Inset Mount Leg Placement</p> <p>Edge Styles</p> <p>Eased (-ES)</p> <p>Beveled (-BV)</p>	<p>Radiused End Connecting Table, Flip-up Top, 27" High, Casters Inset Leg Placement Only</p> <p>Eased Edge Detail 24" W x 48" L x 27" H 30" W x 60" L x 27" H 36" W x 72" L x 27" H</p> <p>Beveled Edge Detail 24" W x 48" L x 27" H 30" W x 60" L x 27" H 36" W x 72" L x 27" H</p>	<p>FP5-244827-ES-IM FP5-306027-ES-IM FP5-367227-ES-IM</p> <p>FP5-244827-BV-IM FP5-306027-BV-IM FP5-367227-BV-IM</p>	<p>2724 3056 3450</p> <p>2724 3056 3450</p>	<p>49 62 78</p> <p>49 62 78</p>
	<p>Radiused End Connecting Table Flip-Up Top, 29" High, Casters Inset Leg Placement Only</p> <p>Eased Edge Detail 24" W x 48" L x 29" H 30" W x 60" L x 29" H 36" W x 72" L x 29" H</p> <p>Beveled Edge Detail 24" W x 48" L x 29" H 30" W x 60" L x 29" H 36" W x 72" L x 29" H</p>	<p>FP5-244829-ES-IM FP5-306029-ES-IM FP5-367229-ES-IM</p> <p>FP5-244829-BV-IM FP5-306029-BV-IM FP5-367229-BV-IM</p>	<p>2777 3108 3502</p> <p>2777 3108 3502</p>	<p>51 64 80</p> <p>51 64 80</p>

OPTIONS (XXXX - REFERS TO TABLE MODEL NUMBER)

MODEL	DESCRIPTION	LIST
XXXX-GD03	Glides	n/c
XXXX-NS09	Non-Skid Glides	20
XXXX-PF06	Premium Base Finish	220
XXXX-GR01	2" Diameter Grommet, Black	76
XXXX-GR02	2" Diameter Grommet, Chrome	92
GC05 (order separately)	Flirt Ganging Connector (per table joint)	100
XXXX-PB1-S	Power Band 1 (one power, two USB), Silver	413
XXXX-PB1-W	Power Band 1 (one power, two USB), White	413
XXXX-PB2-S	Power Band 2 (dual power), Silver	322
XXXX-PB2-W	Power Band 2 (dual power), White	322
XXXX-PB3-S	Power Band 3 (dual power, two USB), Silver	429
XXXX-PB3-W	Power Band 3 (dual power, two USB), White	429

Please refer to pages 6-8 for daisy chain electrical requirements.

NOTES:

- Available in Maple, Walnut and White Oak veneer as well as laminate selections.
- Metal base available in standard and premium finishes, refer to page 2 for options.

SPECIFY:

- Model number
- Wood species
- Wood finish
- Edge detail
- Leg finish
- Options, as applicable

ORDERING EXAMPLE:



#FX6-265029-BV-IM-GC05
 26" x 50" x 29" Video
 Conference End, Fixed Top
 Beveled Edge
 Inset Leg Placement
 Ganging Connector

FLIRT®
MULTI-PURPOSE

designed by 5d studio

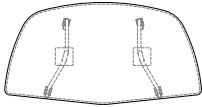

SIN #711-11

		MODEL NUMBER	LIST	WEIGHT	
FX6 SERIES  Inset Mount Leg Placement	Video Conference End Connecting Table, Fixed Top, 27" High, Casters Inset Leg Placement Only Eased Edge Detail 26" W x 50" L x 27" H 32" W x 62" L x 27" H 38" W x 74" L x 27" H	FX6-265027-ES-IM	1988	45	
		FX6-326227-ES-IM	2389	57	
		FX6-387427-ES-IM	2803	71	
		Beveled Edge Detail 26" W x 50" L x 27" H 32" W x 62" L x 27" H 38" W x 74" L x 27" H	FX6-265027-BV-IM	1988	45
			FX6-326227-BV-IM	2389	57
			FX6-387427-BV-IM	2803	71
Edge Styles  Eased (-ES)  Beveled (-BV)	Video Conference End Connecting Table, Fixed Top, w 29" High, Casters Inset Leg Placement Only Eased Edge Detail 26" W x 50" L x 29" H 32" W x 62" L x 29" H 38" W x 74" L x 29" H	FX6-265029-ES-IM	2041	47	
		FX6-326229-ES-IM	2442	59	
		FX6-387429-ES-IM	2855	73	
		Beveled Edge Detail 26" W x 50" L x 29" H 32" W x 62" L x 29" H 38" W x 74" L x 29" H	FX6-265029-BV-IM	2041	47
			FX6-326229-BV-IM	2442	59
			FX6-387429-BV-IM	2855	73

OPTIONS (XXXX - REFERS TO TABLE MODEL NUMBER)

MODEL	DESCRIPTION	LIST
XXXX-GD03	Glides	n/c
XXXX-NS09	Non-Skid Glides	20
XXXX-PF06	Premium Base Finish	220
XXXX-GR01	2" Diameter Grommet, Black	76
XXXX-GR02	2" Diameter Grommet, Chrome	92
GC05 (order separately)	Flirt Ganging Connector (per table joint)	100
XXXX-PB1-S	Power Band 1 (one power, two USB), Silver	413
XXXX-PB1-W	Power Band 1 (one power, two USB), White	413
XXXX-PB2-S	Power Band 2 (dual power), Silver	322
XXXX-PB2-W	Power Band 2 (dual power), White	322
XXXX-PB3-S	Power Band 3 (dual power, two USB), Silver	429
XXXX-PB3-W	Power Band 3 (dual power, two USB), White	429

Please refer to pages 6-8 for daisy chain electrical requirements.

FLIRT® MULTI-PURPOSE

designed by 5d studio



SIN #711-11

NOTES:

- Available in Maple, Walnut and White Oak veneer as well as laminate selections.
- Metal base available in standard and premium finishes, refer to page 2 for options.

SPECIFY:

1. Model number
2. Wood species
3. Wood finish
4. Edge detail
5. Leg finish
6. Options, as applicable

ORDERING EXAMPLE:

#FP6-326227-ES-IM-GD02

32" x 62" x 27" Video Conference End, Flip-Up Top
Eased Edge
Inset Leg Placement
Glides

		MODEL NUMBER	LIST	WEIGHT	
<p>FP6 SERIES</p> <p>Inset Mount Leg Placement</p>	<p>Video Conference End Connecting Table, Flip-Up Top, 27" High, Casters Inset Leg Placement Only</p> <p>Eased Edge Detail 26" W x 50" L x 27" H 32" W x 62" L x 27" H 38" W x 74" L x 27" H</p> <p>Beveled Edge Detail 26" W x 50" L x 27" H 32" W x 62" L x 27" H 38" W x 74" L x 27" H</p>	<p>FP6-265027-ES-IM FP6-326227-ES-IM FP6-387427-ES-IM</p> <p>FP6-265027-BV-IM FP6-326227-BV-IM FP6-387427-BV-IM</p>	<p>2734 3065 3458</p> <p>2734 3065 3458</p>	<p>48 60 74</p> <p>48 60 74</p>	
	<p>Edge Styles</p> <p>Eased (-ES)</p> <p>Beveled (-BV)</p>	<p>Video Conference End Connecting Table, Flip-Up Top, 29" High, Casters Inset Leg Placement Only</p> <p>Eased Edge Detail 26" W x 50" L x 29" H 32" W x 62" L x 29" H 38" W x 74" L x 29" H</p> <p>Beveled Edge Detail 26" W x 50" L x 29" H 32" W x 62" L x 29" H 38" W x 74" L x 29" H</p>	<p>FP6-265029-ES-IM FP6-326229-ES-IM FP6-387429-ES-IM</p> <p>FP6-265029-BV-IM FP6-326229-BV-IM FP6-387429-BV-IM</p>	<p>2785 3118 3511</p> <p>2785 3118 3511</p>	<p>50 62 76</p> <p>50 62 76</p>

OPTIONS (XXXX - REFERS TO TABLE MODEL NUMBER)

MODEL	DESCRIPTION	LIST
XXXX-GD03	Glides	n/c
XXXX-NS09	Non-Skid Glides	20
XXXX-PF06	Premium Base Finish	220
XXXX-GR01	2" Diameter Grommet, Black	76
XXXX-GR02	2" Diameter Grommet, Chrome	92
GC05 (order separately)	Flirt Ganging Connector (per table joint)	100
XXXX-PB1-S	Power Band 1 (one power, two USB), Silver	413
XXXX-PB1-W	Power Band 1 (one power, two USB), White	413
XXXX-PB2-S	Power Band 2 (dual power), Silver	322
XXXX-PB2-W	Power Band 2 (dual power), White	322
XXXX-PB3-S	Power Band 3 (dual power, two USB), Silver	429
XXXX-PB3-W	Power Band 3 (dual power, two USB), White	429

Please refer to pages 6-8 for daisy chain electrical requirements.

NOTES:

- Available in Maple, Walnut and White Oak veneer as well as laminate selections.
- Connecting plates and hardware included.

SPECIFY:

1. Model number
2. Wood species
3. Wood finish
4. Edge detail
5. Options, as applicable

ORDERING EXAMPLE:

#FX7-2424-BV-GRB

24" x 24" Corner Table
Beveled Edge
Black Grommet

FLIRT®
MULTI-PURPOSE

designed by 5d studio

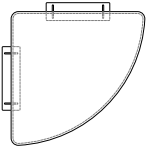

SIN #711-11

		MODEL NUMBER	LIST	WEIGHT
FX7 SERIES	Corner Connecting Table, No Legs			
	Eased Edge Detail			
	24" W x 24" L	FX7-2424-ES	708	11
	30" W x 30" L	FX7-3030-ES	881	16
	36" W x 36" L	FX7-3636-ES	1055	25
	Beveled Edge Detail			
	24" W x 24" L	FX7-2424-BV	708	11
30" W x 30" L	FX7-3030-BV	881	16	
36" W x 36" L	FX7-3636-BV	1055	25	

Edge Styles

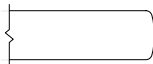

Eased (-ES)

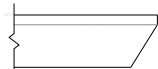

Beveled (-BV)

OPTIONS (XXXX - REFERS TO TABLE MODEL NUMBER)

MODEL	DESCRIPTION	LIST
XXXX-GR01	2" Diameter Grommet, Black	76
XXXX-GR02	2" Diameter Grommet, Chrome	92

FLIRT® MULTI-PURPOSE

designed by 5d studio



SIN #711-11

NOTES:

- Available in Maple, Walnut and White Oak veneer as well as laminate selections.
- 9" wide x 1/2" thick panels available on fixed or flip-up rectangle and trapezoid tables.
- Power units not available on tables specified with modesty panels and inset mount bases.
- Bottom of the panel from the floor dimension is as follows:
 - > 27" high tables - 16 1/4"
 - > 29" high tables - 18 1/4"
 - > 42" high tables - 31 1/2"

SPECIFY:

1. Model number
2. Wood species
3. Wood finish

ORDERING EXAMPLE:

#MP42

Modesty Panel for 48" W Table

		MODEL NUMBER	PANEL LENGTH	VENEER OR LAMINATE	WEIGHT
<p>MODESTY PANELS</p>	<p>Rectangle Top Edge Mount Table Bases</p> <p>Table Length</p> <p>48" 60" 66" 72" 78" 84"</p>	<p>MP42 MP54 MP60 MP66 MP72 MP78</p>	<p>42" 54" 60" 66" 72" 78"</p>	<p>486 595 649 704 759 813</p>	<p>5 6 7 8 9 10</p>
	<p>Rectangle Top Inset Mount Table Bases</p> <p>Table Length</p> <p>60" L 66" L 72" L 78" L 84" L</p>	<p>MP30 MP36 MP42 MP48 MP54</p>	<p>30" 36" 42" 48" 54"</p>	<p>376 431 486 540 595</p>	<p>3 5 6 7 8</p>

NOTES:

- Available in Maple, Walnut and White Oak veneer as well as laminate selections.
- 9" wide x 1/2" thick panels available on fixed or flip-up rectangle and trapezoid tables.
- Bottom of the panel from the floor dimension is as follows:
 - > 27" high tables - 16 1/4"
 - > 29" high tables - 18 1/4"
 - > 42" high tables - 31 1/2"

SPECIFY:

1. Model number
2. Wood species
3. Wood finish

ORDERING EXAMPLE:

#MP24
 Modesty Panel for Trapezoid
 Short Side, 26" x 60" Table

FLIRT®
MULTI-PURPOSE

designed by 5d studio

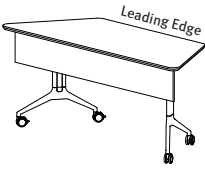
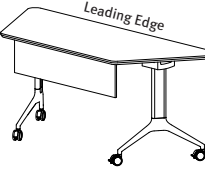

SIN #711-11

		MODEL NUMBER	PANEL LENGTH	VENEER OR LAMINATE	WEIGHT
<p>MODESTY PANELS</p>  <p>Trapezoid Top, Long Side (FP3/FX3 Tables)</p> <p>Leading Edge Length 24" 30" (21" or 26" w) 36"</p>		MP42	42"	486	5
		MP54	54"	595	6
		MP66	66"	704	8
 <p>Trapezoid Top, Short Side (FP2/FX2 Tables)</p> <p>Leading Edge Length 48" 60" (21" w) 60" (26" w) 72"</p>		MP18	18"	267	3
		MP30	30"	376	3
		MP24	24"	322	4
		MP42	42"	486	6

FLIRT® MULTI-PURPOSE

designed by 5d studio



SIN #711-18

M.A.T.E. (MOBILE ALL-PURPOSE TEAMING EASEL) GENERAL PRODUCT FEATURES:

- Available in two widths with overall height of 71" and comes standard with side-mount valet table.
- Material options include Maple, Walnut and White Oak veneer, laminate, upholstered with tackable surface or whiteboard, in any combination.
- All standard wood finishes, excluding #26 Ebony Maple, available on selected wood species.
- For custom wood finishes, please add one-time upcharge of \$400 List per color per order.
- Laminate available in all Arcadia standard laminates.
- For custom laminates, add \$500 List per color per order. Pre-approval required, please contact Customer Service.
- Panels specified with veneer or standard wood grain laminate, panel edge finish will match, unless otherwise specified.
- Panels specified with solid color laminates or whiteboard, panel edge finish will be natural exposed plywood with a clear coat finish.
- Panels specified with veneer or standard wood grain laminate, together with white board and/or pull-out whiteboards, all edges will match the color of the selected veneer or laminate.
- Vinyl, polyurethane and leather upholstery not available.
- Due to standard textile widths, 63" wide easel with upholstery requires a vertical seam. For seamless option, please select a panel fabric.
- Please refer to page 38 for two-tone upholstery examples (different fabrics for each side), yardage requirements and pricing.
- **When specifying, the first option code reflects placement in relation to the right side of the valet table, as facing. Second option code identifies panel material on the opposing side, with the valet table on the left, as facing.**
- Center section (portion between panels) is finished in white laminate as standard. Black laminate available, please specify.
- Storage slot standard on all models excluding upholstered panels. If specified with one side upholstered and one side whiteboard, veneer or laminate, the storage slot will be present on the non-upholstered side only.
- Die-cast aluminum legs available in standard and premium metal finishes and feature four locking casters.

SIDE-MOUNT VALET TABLE FEATURES:

- 15" diameter valet table offered in Maple, Walnut and White Oak veneer as well as laminate selections.
- Table edge finish will follow panel edge finish as standard, unless otherwise specified.
- For double-sided upholstered panels with veneer or standard wood grain laminate table, edge finish will match.
- For double-sided upholstered panels with solid color laminate table, edge finish will be natural exposed plywood with a clear coat finish.

OPTIONS:

- Two non-removable pull-out whiteboards, conveniently hidden inside the unit, available for additional writing surface requirements.
Note: not available with monitor-ready mounting option or upholstered panels.
- Side-mount power unit and monitor-ready mounting options available
- Select from PB1, PB2 and PB3 power units for side placement. Refer to page 3 for details.
- Monitor-ready mounting option available on veneer, laminate or whiteboard panel surfaces and features an upper PB5 power unit, together with PB5 lower side-mount power unit. Monitor and mount not included.
- Monitor placement must be identified (e.g. valet table, right as facing).
- PB5 power unit includes two outlets, two USB charging ports and one HDMI jack.
- Maximum monitor size is 40" for 54" wide unit and 50" for 63" wide unit.
- Electrical cord extends 55" from bottom of unit and can be fed into the exit hole when not in use.

Ancillary pull-out boards

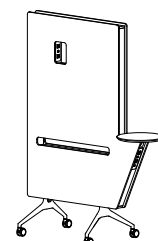
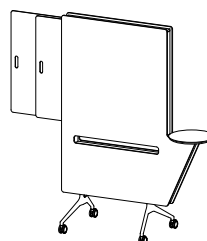

Monitor-ready mount includes cut-out with PB5 unit and side-mount PB5 unit

NOTES:

- Material options include Maple, Walnut and White Oak veneer, laminate or whiteboard, in any combination. Please specify each side with appropriate material code.
- Specify surface material facing valet table on the right first, followed by surface material on the reverse side.
- Center section (between panels) is finished in white laminate as standard.
- Die-cast aluminum legs available in standard and premium metal finishes and feature four locking casters.

SPECIFY:

1. Model number
2. Surface material finish, facing valet table on right side
3. Surface material finish, facing valet table on left side
4. Table wood species
5. Table wood finish
6. Base finish
7. Options, as applicable

ORDERING EXAMPLE:

#6990-395471-V-W



54" Wide M.A.T.E.
Veneer Panel, Table Right Side
Whiteboard Panel, Left Side

**FLIRT®
MULTI-PURPOSE**

designed by 5d studio

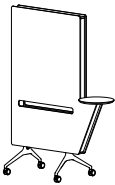
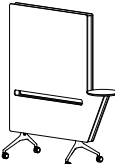

SIN #711-18

		LIST
 <p>6990-395471(-)(-)</p>	<p>54" Wide M.A.T.E. Veneer, Laminate or Whiteboard Panels W 54 D 26¹/₄ H 71 Surface Area 39" Wide Panel Thickness 4¹/₈ 104 lbs.</p>	3468
 <p>6990-486371(-)(-)</p>	<p>63" Wide M.A.T.E. Veneer, Laminate or Whiteboard Panels W 63 D 26¹/₄ H 71 Surface Area 48" Wide Panel Thickness 4¹/₈ 116 lbs.</p>	4016
 <p>6991-395471(-)(-)</p>	<p>54" Wide M.A.T.E. with Pull-Out Whiteboards Veneer, Laminate or Whiteboard Panels W 54 D 26¹/₄ H 71 Surface Area 39" Wide Panel Thickness 4¹/₈ 126 lbs.</p>	4714
<p>Specify Surface Material Facing Valet Tablet on the Right First, Followed by Surface Material on the Reverse Side Veneer (-V) Laminate (-L) Whiteboard (-W)</p>		

OPTIONS (XXXX - REFERS TO M.A.T.E. MODEL NUMBER)

MODEL	DESCRIPTION	LIST
XXXX-PF02	Premium Base Finish	80
XXXX-MR1*	Monitor Ready Mounting on Surface with Valet Table Placement on Right Side, as facing	1320
XXXX-MR2*	Monitor Ready Mounting on Surface with Valet Table Placement on Left Side, as facing	1320
XXXX-PB1-S	Power Band 1 (one power, two USB), Silver	413
XXXX-PB1-W	Power Band 1 (one power, two USB), White	413
XXXX-PB2-S	Power Band 2 (dual power), Silver	322
XXXX-PB2-W	Power Band 2 (dual power), White	322
XXXX-PB3-S	Power Band 3 (dual power, two USB), Silver	429
XXXX-PB3-W	Power Band 3 (dual power, two USB), White	429

*Includes two PB5 power units. Not available with pull-out whiteboards.

FLIRT® MULTI-PURPOSE

designed by 5d studio



NOTES:

- Upholstered with tackable surface on both sides.
- Note: due to standard textile widths, 63" wide easel requires a vertical seam on both sides. For seamless option, please select a panel fabric.
- Center section (between panels) is finished in white laminate as standard.
- Die-cast aluminum legs available in standard and premium metal finishes and feature four locking casters.

SPECIFY:

1. Model number
2. Upholstery selection
3. Table wood species
4. Table wood finish
5. Base finish
6. Options, as applicable

ORDERING EXAMPLE:

#6990-486371-U-U-PF02

54" Wide M.A.T.E.
Upholstered Panels, Both Sides
Premium Base Finish

SIN #711-18

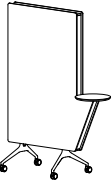
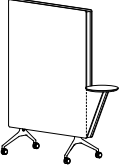
MODEL NUMBER	PRODUCT SPECIFICATIONS	FABRIC GRADES								
		COM	1	2	3	4	5	6	7	8
<p>6990-395471-U-U</p> 	<p>54" Wide M.A.T.E. Upholstered Panels, Both Sides W 54 D 26¹/₄ H 71 Surface Area 39" Wide Panel Thickness 4¹/₈ 3³/₄ yds. 104 lbs. TB133, add \$180 List</p>	2874	3087	3138	3229	3319	3406	3497	3579	3670
<p>6990-486371-U-U</p> 	<p>63" Wide M.A.T.E. Upholstered Panels, Both Sides W 63 D 26¹/₄ H 71 Surface Area 48" Wide Panel Thickness 4¹/₈ 4¹/₂ yds. 116 lbs. TB133, add \$216 List</p>	3329	3585	3646	3755	3863	3967	4076	4175	4284

OPTIONS (XXXX - REFERS TO M.A.T.E MODEL NUMBER)

MODEL	DESCRIPTION	LIST
XXXX-PF02	Premium Base Finish	80
XXXX-PB1-S	Power Band 1 (one power, two USB), Silver	413
XXXX-PB1-W	Power Band 1 (one power, two USB), White	413
XXXX-PB2-S	Power Band 2 (dual power), Silver	322
XXXX-PB2-W	Power Band 2 (dual power), White	322
XXXX-PB3-S	Power Band 3 (dual power, two USB), Silver	429
XXXX-PB3-W	Power Band 3 (dual power, two USB), White	429

NOTES:

- Upholstered with tackable surface on one side with veneer, laminate or whiteboard on the flip side.
- Note: due to standard textile widths, 63" wide easel requires a vertical seam on the upholstered side. For seamless option, please select a panel fabric.
- Specify surface material facing valet table on the right first, followed by surface material on the reverse side.
- Center section (between panels) is finished in white laminate as standard.
- Die-cast aluminum legs available in standard and premium metal finishes and feature four locking casters.

SPECIFY:

- Model number
- Upholstery selection
- Panel surface finish
- Table wood species
- Table wood finish
- Base finish
- Options, as applicable

ORDERING EXAMPLE:

#6990-395471-U-V-MR1
 54" Wide M.A.T.E.
 Upholstered Panel, Table Right Side
 Veneer Panel, Flip Side
 Monitor Ready Mount

FLIRT®
MULTI-PURPOSE

designed by 5d studio

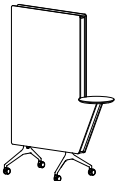
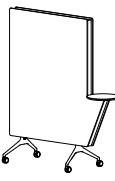

SIN #711-18

MODEL NUMBER	PRODUCT SPECIFICATIONS	FABRIC GRADES							
		COM	1	2	3	4	5	6	7
 <p>6990-395471-(-)(-) 54" Wide M.A.T.E. Upholstered Panel One Side Veneer, Laminate or Whiteboard Panel on Flip Side W 54 D 26¹/₄ H 71 Surface Area 39" Wide Panel Thickness 4¹/₈ 2 yds. 104 lbs. TB133, add \$96 List</p>	Veneer (-V) Laminate (-L) 3171 Upholstered (-U) 3285 Whiteboard (-W) 3312	3360	3409	3455	3503	3547	3596		
 <p>6990-486371-(-)(-) 63" Wide M.A.T.E. Upholstered Panel One Side Veneer, Laminate or Whiteboard Panel on Flip Side W 63 D 26¹/₄ H 71 Surface Area 48" Wide Panel Thickness 4¹/₈ 2³/₄ yds. 116 lbs. TB133, add \$132 List</p>	Veneer (-V) Laminate (-L) 3672 Upholstered (-U) 3828 Whiteboard (-W) 3866	3932	3999	4062	4129	4189	4256		

Specify Surface Material Facing Valet Tablet on the Right First, Followed by Surface Material on the Reverse Side
 Veneer (-V)
 Laminate (-L)
 Upholstered (-U)
 Whiteboard (-W)

OPTIONS (XXXX - REFERS TO M.A.T.E. MODEL NUMBER)

MODEL	DESCRIPTION	LIST
XXXX-PF02	Premium Base Finish	80
XXXX-MR1*	Monitor Ready Mounting on Surface with Valet Table Placement on Right Side, as facing	1320
XXXX-MR2*	Monitor Ready Mounting on Surface with Valet Table Placement on Left Side, as facing	1320
XXXX-PB1-S	Power Band 1 (one power, two USB), Silver	413
XXXX-PB1-W	Power Band 1 (one power, two USB), White	413
XXXX-PB2-S	Power Band 2 (dual power), Silver	322
XXXX-PB2-W	Power Band 2 (dual power), White	322
XXXX-PB3-S	Power Band 3 (dual power, two USB), Silver	429
XXXX-PB3-W	Power Band 3 (dual power, two USB), White	429

*Includes two PB5 power units. Not available on upholstered panel side.

FLIRT™ MULTI-PURPOSE

designed by 5d studio



SIN #711-18

DIVIDER SCREENS PRODUCT FEATURES:

- Available in two widths with overall height of 71".
- Material options include Maple, Walnut and White Oak veneer, laminate, upholstered with tackable surface or whiteboard, in any combination.
- All standard wood finishes, excluding #26 Ebony Maple, available on selected wood species.
- For custom wood finishes, please add one-time upcharge of \$400 List per color per order.
- Laminate available in all Arcadia standard laminates.
- For custom laminates, add \$500 List per color per order. Pre-approval required, please contact Customer Service.
- Panels specified with veneer or standard wood grain laminate, panel edge finish will match, unless otherwise specified.
- Panels specified with solid color laminates or whiteboard, panel edge finish will be natural exposed plywood with a clear coat finish.
- Vinyl, polyurethane and leather upholstery not available.
- Please refer to page 38 for two-tone upholstery examples (different fabrics for each side), yardage requirements and pricing.
- Center section (portion between panels) is finished in white laminate as standard. Black laminate available, please specify.
- Die-cast aluminum legs available in standard and premium metal finishes and feature four locking casters.

OPTIONS:

- Monitor-ready mounting option available on veneer, laminate or whiteboard panel surfaces and features a PB3 power unit.
- **When specifying, select appropriate option code based on the applicable panel material side (e.g. #6995-3971-V-WB-MR3, indicates the mount will be applied to the veneer side of the screen vs. #6995-3971-V-WB-MR4, which indicates the mount will be on the whiteboard panel side).**
- PB3 unit features two outlets and two USB charging ports.
- Maximum monitor size is 40" for 54" wide unit and 50" for 63" wide unit.
- Electrical cord extends 55" from bottom of unit and can be fed into the exit hole when not in use.

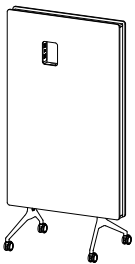

Monitor-ready mount includes cut-out with PB3 unit.

NOTES:

- Material options include Maple, Walnut and White Oak veneer, laminate or whiteboard, in any combination. Please specify appropriate material code for each side.
- Center section (between panels) is finished in white laminate as standard.
- Die-cast aluminum legs available in standard and premium metal finishes and feature four locking casters.

SPECIFY:

1. Model number
2. Upholstery selection
3. Table wood species
4. Table wood finish
5. Base finish
6. Options, as applicable

ORDERING EXAMPLE:

#6995-3971-V-WB-PF02

39" Wide Screen
Veneer Panel
Whiteboard Panel
Premium Base Finish

**FLIRT®
MULTI-PURPOSE**

designed by 5d studio

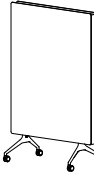

SIN #711-18

		LIST
<p>6995-3971-()-()</p> 	<p>39" Wide Divider Screen Veneer, Laminate or Whiteboard Panels W 39 D 26¹/₄ H 71 Panel Thickness 4¹/₈ 76 lbs.</p>	<p>3222</p>
<p>6995-4871-()-()</p> 	<p>48" Wide Divider Screen Veneer, Laminate or Whiteboard Panels W 48 D 26¹/₄ H 71 Panel Thickness 4¹/₈ 88 lbs.</p>	<p>3463</p>

Specify Each Side
Veneer (-V)
Laminate (-L)
Whiteboard (-W)

OPTIONS (XXXX - REFERS TO SCREEN MODEL NUMBER)

MODEL	DESCRIPTION	LIST
XXXX-PF02	Premium Base Finish	80
XXXX-MR3*	Monitor Ready Mounting Placement on Panel Material Specified First	400
XXXX-MR4*	Monitor Ready Mounting Placement on Panel Material Specified Second	400

*Includes one PB3 power unit

FLIRT® MULTI-PURPOSE

designed by 5d studio



NOTES:

- Upholstered with tackable surface on both sides.
- Center section (between panels) is finished in white laminate as standard.
- Die-cast aluminum legs available in standard and premium metal finishes and feature four locking casters.

SPECIFY:

1. Model number
2. Upholstery selection
3. Base finish
4. Options, as applicable

ORDERING EXAMPLE:

#6995-4871-U-U-PF02
48" Wide Screen
Upholstered Panels, Both Sides
Premium Base Finish

SIN #711-18

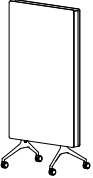
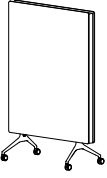
MODEL NUMBER	PRODUCT SPECIFICATIONS	FABRIC GRADES								
		COM	1	2	3	4	5	6	7	8
<p>6995-3971-U-U</p> 	<p>39" Wide Divider Screen Upholstered Panels, Both Sides W 39 D 26¹/₄ H 71 Panel Thickness 4¹/₈ 3³/₄ yds. 76 lbs. TB133, add \$180 List</p>	2512	2725	2776	2867	2957	3044	3135	3217	3308
<p>6995-4871-U-U</p> 	<p>48" Wide Divider Screen Upholstered Panels, Both Sides W 48 D 26¹/₄ H 71 Panel Thickness 4¹/₈ 3³/₄ yds. 88 lbs. TB133, add \$180 List</p>	2725	2938	2989	3080	3170	3257	3348	3430	3521

OPTIONS (XXXX - REFERS TO SCREEN MODEL NUMBER)

MODEL	DESCRIPTION	LIST
XXXX-PF02	Premium Base Finish	80

NOTES:

- Upholstered with tackable surface on one side with veneer, laminate or whiteboard on the flip side. Please specify appropriate material code for each side.
- Center section (between panels) is finished in white laminate as standard.
- Die-cast aluminum legs available in standard and premium metal finishes and feature four locking casters.

SPECIFY:

- Model number
- Upholstery selection
- Panel surface material
- Base finish
- Options, as applicable

ORDERING EXAMPLE:

#6995-3971-U-W-MR2

39" Wide Screen
Upholstered Panel
Whiteboard Panel, Flip Side
Monitor Ready Mount

FLIRT®
MULTI-PURPOSE

designed by 5d studio

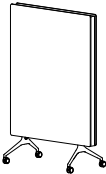

SIN #711-18

MODEL NUMBER	PRODUCT SPECIFICATIONS	FABRIC GRADES									
		PANEL FLIP SIDE MATERIAL	COM	1	2	3	4	5	6	7	8
6995-3971-U(-) 	39" Wide Divider Screen Upholstered Panel One Side Veneer, Laminate or Whiteboard Panel on Flip Side W 39 D 26 ¹ / ₄ H 71 Panel Thickness 4 ¹ / ₈ 2 yds. 76 lbs. TB133, add \$96 List	Veneer (-V)									
		Laminate (-L)	2867	2981	3008	3056	3105	3151	3199	3243	3292
6995-4871-U(-) 	48" Wide Divider Screen Upholstered Panel One Side Veneer, Laminate or Whiteboard Panel on Flip Side W 48 D 26 ¹ / ₄ H 71 Panel Thickness 4 ¹ / ₈ 2 yds. 88 lbs. TB133, add \$96 List	Veneer (-V)									
		Laminate (-L)	3095	3209	3236	3284	3333	3379	3427	3471	3520
OPTIONS (XXXX - REFERS TO SCREEN MODEL NUMBER)											

MODEL	DESCRIPTION	LIST
XXXX-PF02	Premium Base Finish	80
XXXX-MR4	Monitor Ready Mounting - includes one PB3 power unit (non-upholstered side only)	400

FLIRT® MULTI-PURPOSE

designed by 5d studio

UPHOLSTERY COMBINATIONS:

For fabric combinations, refer to the pricing below:

- When combining **two** COM fabrics, or fabrics with the same grade, add \$65 List per unit.
 - When combining different grades of fabric, price will be based on the highest grade specified.
 - Note: Yardage amounts are based on fabric which is plain (i.e. non-directional) and a full 54" wide.
- **Appropriate upholstery code must be included on order.**

SIN #711-18

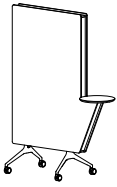

Code FL4

Model
6990-54-U-U

COM Requirement
Single Panel = 2 yds.

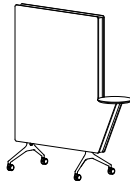

Code FL5

Model
6990-63-U-U

COM Requirement
Single Panel = 2³/₄ yds.



Code FL6

Model
6995-39-U-U

COM Requirement
Single Panel = 2 yds.

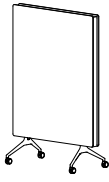

Code FL7

Model
6995-48-U-U

COM Requirement
Single Panel = 2 yds.

FLIRT[®]

OCCASIONAL TABLES

designed by 5d studio



SIN #711-11

PRODUCT FEATURES:

- Round and arc square top shapes.
- 15" table height.
- Custom heights up to 25" available, please specify and add \$200 List upcharge per unit.
- Table column diameter: 2¹/₄".
- Four table surface options: veneer, laminate, Corian or back-painted glass.
- Veneer offered in Maple, Walnut and White Oak wood species.
- All standard and custom wood finishes available.
- For custom wood finishes, please add one-time upcharge of \$400 List per color per order.
- Laminate tops available in all Arcadia standard laminates.
- For custom laminates, add \$500 List per color per order. Pre-approval required, please contact Customer Service.
- Corian top available in four standard colors. Please note that a 1¹/₈" reveal will be present.
- Glass is back-painted white as standard and may be used as a writable surface with dry-erase markers.
- For non-standard Corian or back-painted glass colors, please contact Customer Service for pricing.
- Metal pedestal base manufactured in aluminum and offered in standard as well as premium finish selections.
- For custom finish colors, please contact Customer Service for pricing.
- Base standard with adjustable glides.
- Non-skid glide option available for hard-surface floors. Please specify "NS04" after model number and add \$20 List per unit.
- Base design facilitates wire management for through-the-surface electrical and/or data capability.

EDGE DETAIL FEATURES:

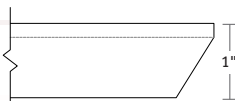

Veneer/Laminate Top - Edge Profile



Corian Top - Edge Profile

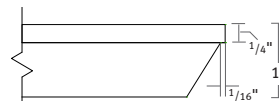

Back-Painted Glass - Edge Profile

- Beveled edge detail, 1" thick.
- Table with veneer or standard wood grain laminate top, edge finish will match top finish color, unless otherwise specified.
- For all other finishes (solid color laminates, Corian and back-painted glass), edge will be natural exposed plywood with a clear coat finish as standard, unless otherwise specified.
- For Corian tops, a 1/8" reveal will be present.

FLIRT[®]

OCCASIONAL TABLES

designed by 5d studio



SIN #711-11

CORIAN[®] COLORS:

Designer White
Linen
Rain Cloud
Witch Hazel

Corian[®] is a registered trademark of Dupont.

STANDARD BASE FINISH COLORS:

#06 Charcoal Grey #92 Polished Aluminum
#90 Metallic Silver #95 Satin Black

PREMIUM BASE FINISH COLORS:

#07 Gold Shimmer #83 Metallic Champagne
#08 Penny #94 Cotton
#09 Brown Sugar

PORTAL POWER UNITS:

- Available on all table sizes and heights.
- Dimensions: 5¹/₄" W x 4¹/₄" L
- Touch latch lid provides easy access to data and electrical features.
- Satin nickel finish.

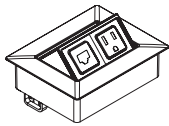

PP1

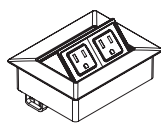

PP2

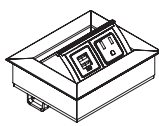

PP3

- PP1 unit features one simplex outlet with 72" electrical cord and one RJ-45 jack (Cat 6) with 72" patch cable.
- PP2 unit features two simplex outlets with 72" electrical cord.
- PP3 unit features one simplex outlet with 72" electrical cord and two USB charging ports.

NOTES:

- Available in Maple, Walnut and White Oak veneer, as well as laminate, Corian and back-painted glass.
- Base available in all standard and premium metal finishes.

SPECIFY:

- Model number
- Wood species, as applicable
- Wood finish, as applicable
- Base finish
- Options, as applicable

ORDERING EXAMPLE:

#FX9-303015-BV-PF03-PP1



30" x 30" Arc-Square Table
Premium Base Finish
Portal Power 1 Unit

FLIRT®
OCCASIONAL TABLES

designed by 5d studio



SIN #711-11

		MODEL NUMBER	VENEER OR LAMINATE	CORIAN (-CO)	BACK-PAINTED GLASS (-PG)	WEIGHT
FX8 SERIES	Q S Round Top, 15" Height					
	24" Dia. x 15" H	FX8-2415-BV	1018	1607	1412	22
	29" Dia. x 15" H	FX8-2915-BV	1268	2190	1717	30
	36" Dia. x 15" H	FX8-3615-BV	1470	2994	1965	40
	42" Dia. x 15" H	FX8-4215-BV	1769	3842	2320	51
FX9 SERIES	Q S Arc-Square Top, 15" Height					
	24" W x 24" L x 15" H	FX9-242415-BV	1213	1802	1719	22
	30" W x 30" L x 15" H	FX9-303015-BV	1279	2201	1851	30
	36" W x 36" L x 15" H	FX9-363615-BV	1485	3009	2118	40
	42" W x 42" L x 15" H	FX9-424215-BV	1788	3861	2503	51

OPTIONS (XXXX - REFERS TO TABLE MODEL NUMBER)

MODEL	DESCRIPTION	LIST
XXXX-NS04	Non-Skid Glides	20
XXXX-PF03	Premium Base Finish	110
XXXX-PP1	Portal Power 1 (1 Power, 1 Data)	612
XXXX-PP2	Portal Power 2 (Dual Power)	542
XXXX-PP3	Portal Power 3 (1 Power, 2 USB)	643
XXXX-PC	Glass Top Electrical Unit Cut-Out	68

Q S = Available on Quick-Ship Program, all sizes and surface materials (Polished Aluminum and Metallic Silver finishes only).

NOTES:

- Fixed seat cushion.
- 6" leg height clearance.
- Beech wood or metal legs.
- Wood legs and center table available in all standard and custom wood finishes available on Beech.
- For custom wood finishes, please add \$400 List per color per order.
- Metal legs available in #06 Charcoal Grey and #90 Metallic Silver.

SPECIFY:

1. Model number
2. Leg finish
3. Upholstery selection
4. Table finish, as applicable
5. Options, as applicable

ORDERING EXAMPLE:

#4992-MB03

Two-Seat Bench, Wood Legs
Moisture Barrier

HAVEN BENCHES

designed by david dahl



SIN #711-16

MODEL NUMBER	PRODUCT SPECIFICATIONS		FABRIC GRADES							LEATHER GRADES				
			COM	1	2	COL			4	5	6	7	8	L1
4992 (WOOD LEGS) M4992 (METAL LEGS)	Two-Seat Bench W 50 ¹ / ₂ D 21 H 18 Seat Height 18 3 Yds. 66 lbs. COL 60 Sq. Ft. TB 133, add \$144 List	Wood Legs	1362	1533	1574	1646	1718	1788	1860	1926	1999	2330	2572	2808
		Metal Legs	1322	1493	1534	1606	1678	1748	1820	1886	1959	2290	2532	2768
4992-CT (WOOD LEGS) M4992-CT (METAL LEGS)	Two-Seat Bench with Center Table W 72 D 21 H 18 Seat Height 18 3 ¹ / ₂ Yds. 98 lbs. COL 70 Sq. Ft. TB 133, add \$168 List	Wood Legs	1895	2094	2142	2226	2311	2392	2476	2553	2638	3024	3307	3582
		Metal Legs	1839	2038	2086	2170	2255	2336	2420	2497	2582	2968	3251	3526
4993 (WOOD LEGS) M4993 (METAL LEGS)	Three-Seat Bench W 72 D 21 H 18 Seat Height 18 4 ¹ / ₄ Yds. 98 lbs. COL 85 Sq. Ft. TB 133, add \$204 List	Wood Legs	1739	1980	2038	2141	2244	2342	2445	2538	2641	3109	3453	3788
		Metal Legs	1688	1929	1987	2090	2193	2291	2394	2487	2590	3058	3402	3737

OPTIONS (XXXX - REFERS TO BENCH MODEL NUMBER)

MODEL	DESCRIPTION	LIST	WEIGHT CAPACITY
XXXX-MB03	Moisture Barrier, Two-Seat Benches	145	#4992/#M4992 800 lbs.
XXXX-MB04	Moisture Barrier, Three-Seat Benches	170	#4992-CT/#M4992-CT 800 lbs.
XXXX-NS02B	Non-Skid Glides	20	#4993/#M4993 1200 lbs.

HAVEN BENCHES

designed by david dahl



SIN #711-16

UPHOLSTERY COMBINATIONS:

For fabric vinyl or leather upholstery combinations refer to the pricing below:

- When combining **two** COM/COV/COL fabrics or fabrics with the same grade price will be \$65 List (per unit).
 - When combining **three or more** COM/COV/COL fabrics or fabrics with the same grade price will be \$75 List (per unit).
 - When combining different grades of fabric price will be based on the highest grade specified.
- Two-tone upholstery examples and yardage requirements for the most common combinations are listed below. Additional combinations available please contact Customer Service for yardage requirements and pricing.
 - Note: Yardage amounts are based on fabric which is plain (i.e. non-directional) and a full 54" wide.
 - **Appropriate upholstery code must be included on order.**

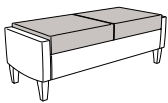

Code HA42

<u>Models</u>	<u>COM Requirement</u>
4992	Seat Cushion Only = 2 yds.
M4992	Balance of Bench = 2 yds.

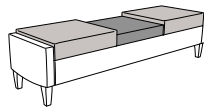

Code HA43

<u>Models</u>	<u>COM Requirement</u>
4992-CT	Seat Cushion Only = 2 yds.
M4992-CT	Balance of Bench = 2 ¹ / ₄ yds.

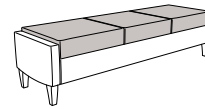

Code HA44

<u>Models</u>	<u>COM Requirement</u>
4993	Seat Cushion Only = 3 yds.
M4993	Balance of Bench = 2 ¹ / ₄ yds.

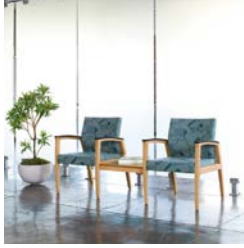

HAVEN GUEST-TANDEM

designed by david dahl



SIN #711-17

GUEST, BARIATRIC, PATIENT AND EASY ACCESS/HIP CHAIR PRODUCT FEATURES:

- All models available in two frame options: Beech hardwood or Metal.
- Metal frame available in #06 Charcoal Grey and #90 Metallic Silver. For non-standard options, please contact Customer Service.
- Armless, open arm and inset panel arm options.
- Arm caps available in Beech wood, black urethane or Corian.
- Corian arm caps available in four standard colors. For non-standard colors, please contact Customer Service for pricing.
- All standard and custom wood finishes available on Beech.
- For custom wood finishes, please add \$400 List per color per order.
- Field-replaceable arm caps featured on open arm models only.
- Bariatric settee available in two sizes.
- All models feature passive flex back capability.
- Non-skid glides available for hard surface floors. Refer to individual pages for specification information and pricing.
- Optional replaceable seat and back cover available. Refer to individual pages for specification information and pricing.
- All dimensions are nominal.

CORIAN® COLORS:

Designer White
Linen
Rain Cloud
Witch Hazel

Corian® is a registered trademark of Dupont.

TANDEM SEATING PRODUCT FEATURES:

- Two frame options: Beech hardwood or Metal.
- Available in two and three-seat combinations or as reconfigurable modular units.
- Two and three-seat preconfigured combinations available with or without center legs, as well as with or without center arms.
- Open arm and panel arm models.
- Arm caps available in Beech wood, black urethane or Corian.
- Field-replaceable arm caps featured on open arm models only.
- Bariatric settee available in two sizes.
- All models feature passive flex back capability.
- In-line bench seats offered in two sizes.
- Multiple sizes of end, in-line and corner tables available in Beech veneer, laminate or with a Corian top.
- Beech veneer and laminate tops are $\frac{3}{4}$ " thick with hardwood edge.
- Corian tops are $\frac{1}{2}$ " thick.
- All standard and custom wood finishes available on Beech.
- For custom wood finishes, please add \$400 List per color per order.
- When ordering in laminate, specify laminate manufacturer, color and pattern number.
- If standard laminate is specified, no upcharge.
- For custom laminates, add \$500 List per color per order. Pre-approval required, please contact Customer Service.
- Non-skid glides available for hard surface floors. Refer to individual pages for specification information and pricing.

HAVEN GUEST-TANDEM

designed by david dahl



SIN #711-17

TANDEM SEATING PRODUCT FEATURES CONTINUED:

- Optional replaceable seat and back cover available. Refer to individual pages for specification information and pricing.
- **Note: Please include seating/table layout drawings or sketch with each order.**
- Arcadia will pre-assemble units at the factory to maximize shipping allowances and minimize field assembly.
- All dimensions are nominal.

WEIGHT CAPACITY:

- Guest Chair 350 lbs.
- Tandem on Beam 250 lbs. per seat (no center leg models)
- Reconfigurable Tandem 350 lbs. per seat
- Bariatric Chairs 750 lbs. per seat
- Easy Access/Hip Chairs 350 lbs.
- Patient Chairs 350 lbs.

SPECIAL FEATURES:

ARM CAP:

- Radiused edges for smooth surface contact.
- Finger-grip design for added stability.
- Generously proportioned to provide greater support.
- Field-replaceable arm caps featured on open arm models only.



METAL SEAT FRAME:

- Metal seat frame construction ensures durability and allows in-field component replacement as well as add-on capability for tandem units.



FLEX BACK:

- Featured on all models including bariatric sizes, patient chair and easy access/hip chair.
- Passive flex back motion provides long-term seated comfort.



OPTIONAL REPLACEABLE UPHOLSTERY:

- Available on seats and backs of all guest models including bariatric sizes as well as the easy access/hip chair.
- Available on seats of patient chair models.
- Replacement seat and back covers can be easily field installed on previously ordered Haven models with standard fixed upholstery. Contact Customer Service for instructions.



CLEAN-OUT PORTAL:

- Featured on all models including bariatric sizes, patient chair and easy access/hip chair.
- Clean-out area between seat and back enables crumbs and debris to fall through for maintenance ease.



ADDITIONAL STANDARD FEATURES:

- Radiused edges.
- Wall-saver leg design.
- Two-tone upholstery combinations available. Please refer to page 24 for examples, yardage requirements and pricing.
- For complete list of replaceable components, please refer to pages 20-23.

NOTES:

- Beech hardwood or metal frame.
- Three arm cap options: Beech wood, black urethane or Corian.
- For Corian arm caps, please specify “-CO” in place of the “-W” after model number (with color selection) and refer to options below for upcharge.
- Refer to page 24 for two-tone upholstery examples and yardage requirements.

SPECIFY:

1. Model number
2. Frame finish
3. Arm cap finish, as applicable
4. Upholstery selection
5. Options, as applicable

ORDERING EXAMPLE:

#4910-CO-SC01-NS02B





Guest Chair, Wood Frame
Corian Arm Caps
Replaceable Seat Cover
Non-Skid Glides

HAVEN GUEST-TANDEM

designed by david dahl



SIN #711-17

MODEL NUMBER	PRODUCT SPECIFICATIONS	FABRIC GRADES										LEATHER GRADES					
		COM	1	2	COL			4	5	6	7	8	L1	L2	L3		
4910-W M4910-W (METAL FRAME) 	Q S Guest Chair, Open Arm Wood Arm Caps W 25 D 25 ³ / ₄ H 34 Seat Height 18 Inside Seat Width 21 Inside Seat Depth 18 ¹ / ₂ Arm Height 25 ³ / ₄ 1 ³ / ₄ Yds. 39 lbs. TB 133, add \$84 List	Wood Frame	1124	1224	1248	1290	1332	1373	1415	1453	1496	1689	1830	1968			
		Metal Frame	1090	1190	1214	1256	1298	1339	1381	1419	1462	1655	1796	1934			
4910-W-PA M4910-W-PA (METAL FRAME) 	Guest Chair, Panel Arm Wood Arm Caps W 25 D 25 ³ / ₄ H 34 Seat Height 18 Inside Seat Width 21 Inside Seat Depth 18 ¹ / ₂ Arm Height 25 ³ / ₄ 2 ³ / ₄ Yds. 45 lbs. TB 133, add \$132 List	Wood Frame	1311	1467	1505	1571	1638	1701	1768	1828	1895	2198	2420	2637			
		Metal Frame	1278	1434	1472	1538	1605	1668	1735	1795	1862	2165	2387	2604			
4910-U M4910-U (METAL FRAME) 	Q S Guest Chair, Open Arm Black Urethane Arm Caps W 25 D 25 ³ / ₄ H 34 Seat Height 18 Inside Seat Width 21 Inside Seat Depth 18 ¹ / ₂ Arm Height 25 ³ / ₄ 1 ³ / ₄ Yds. 39 lbs. TB 133, add \$84 List	Wood Frame	1124	1224	1248	1290	1332	1373	1415	1453	1496	1689	1830	1968			
		Metal Frame	1090	1190	1214	1256	1298	1339	1381	1419	1462	1655	1796	1934			
4910-U-PA M4910-U-PA (METAL FRAME) 	Guest Chair, Panel Arm Black Urethane Arm Caps W 25 D 25 ³ / ₄ H 34 Seat Height 18 Inside Seat Width 21 Inside Seat Depth 18 ¹ / ₂ Arm Height 25 ³ / ₄ 2 ³ / ₄ Yds. 45 lbs. TB 133, add \$132 List	Wood Frame	1311	1467	1505	1571	1638	1701	1768	1828	1895	2198	2420	2637			
		Metal Frame	1278	1434	1472	1538	1605	1668	1735	1795	1862	2165	2387	2604			

OPTIONS (XXXX - REFERS TO CHAIR MODEL NUMBER)

MODEL	DESCRIPTION	LIST
XXXX-CO	Corian Arm Caps	100
XXXX-SC01	Replaceable Seat Cover (per unit)	45
XXXX-BC01	Replaceable Back Cover (per unit)	30
XXXX-MB01	Moisture Barrier (seat only, per unit)	50
XXXX-NS02B	Non-Skid Glides (per unit)	20

Q S = Available on Quick-Ship Program, Wood or Metal Frame (Metallic Silver finish only).

HAVEN GUEST-TANDEM

designed by david dahl



NOTES:

- Pre-configured tandem units.
- Beech hardwood or metal frame.
- Upholstered inset panel arm available. Please add "-PA" to model number and refer to yardage requirements and pricing listed below.
- Three arm cap options: Beech wood, black urethane or Corian.
- Please refer to page 6 for connecting table options.
- Models can be combined with reconfigurable modular units.

SPECIFY:

1. Model number
2. Frame finish
3. Arm cap finish, as applicable
4. Upholstery selection
5. Options, as applicable

ORDERING EXAMPLE:

#4910-3-W-MB01

Three-Seater, Wood Frame
Wood Arm Caps
Moisture Barrier

SIN #711-17

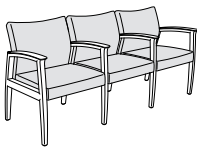
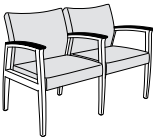
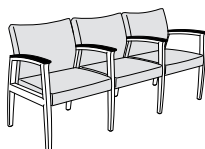
MODEL NUMBER	PRODUCT SPECIFICATIONS	FABRIC GRADES							LEATHER GRADES					
		COM	1	2	COL			4	5	6	7	8	L1	L2
4910-2-W M4910-2-W (METAL FRAME) 	Two-Seater, Wood Arm Caps W 48 D 25 ³ / ₄ H 34 Seat Height 18 Inside Seat Width 21 Inside Seat Depth 18 ¹ / ₂ Arm Height 25 ³ / ₄ 3 ¹ / ₂ Yds. 73 lbs. TB 133, add \$168 List	Wood Frame	2001	2200	2248	2332	2417	2498	2582	2659	2744	3130	3413	3688
		Metal Frame	1942	2141	2189	2273	2358	2439	2523	2600	2685	3071	3354	3629
4910-3-W M4910-3-W (METAL FRAME) 	Three-Seater, Wood Arm Caps W 72 D 25 ³ / ₄ H 34 Seat Height 18 Inside Seat Width 21 Inside Seat Depth 18 ¹ / ₂ Arm Height 25 ³ / ₄ 5 ¹ / ₄ Yds. 107 lbs. TB 133, add \$252 List	Wood Frame	2855	3153	3225	3352	3478	3600	3726	3842	3969	4548	4972	5386
		Metal Frame	2771	3069	3141	3268	3394	3516	3642	3758	3885	4464	4888	5302
4910-2-U M4910-2-U (METAL FRAME) 	Two-Seater, Black Urethane Arm Caps W 48 D 25 ³ / ₄ H 34 Seat Height 18 Inside Seat Width 21 Inside Seat Depth 18 ¹ / ₂ Arm Height 25 ³ / ₄ 3 ¹ / ₂ Yds. 73 lbs. TB 133, add \$168 List	Wood Frame	2001	2200	2248	2332	2417	2498	2582	2659	2744	3130	3413	3688
		Metal Frame	1942	2141	2189	2273	2358	2439	2523	2600	2685	3071	3354	3629
4910-3-U M4910-3-U (METAL FRAME) 	Three-Seater, Black Urethane Arm Caps W 72 D 25 ³ / ₄ H 34 Seat Height 18 Inside Seat Width 21 Inside Seat Depth 18 ¹ / ₂ Arm Height 25 ³ / ₄ 5 ¹ / ₄ Yds. 107 lbs. TB 133, add \$252 List	Wood Frame	2855	3153	3225	3352	3478	3600	3726	3842	3969	4548	4972	5386
		Metal Frame	2771	3069	3141	3268	3394	3516	3642	3758	3885	4464	4888	5302
-PA	Upholstered Inset Panel Arm (wood or metal frame, per arm) 1/2 Yd. TB 133, add \$24 List per arm		96	125	132	144	156	167	179	190	203	258	298	337

OPTIONS (XXXX - REFERS TO CHAIR MODEL NUMBER)

MODEL	DESCRIPTION	LIST
XXXX-CO	Corian Arm Caps (per arm)	50
XXXX-SC01	Replaceable Seat Cover (per seat)	45
XXXX-BC01	Replaceable Back Cover (per back)	30
XXXX-MB01	Moisture Barrier (seat only, per seat)	50
XXXX-NS02A	Non-Skid Glides (per arm frame)	10

NOTES:

- Beech hardwood or metal frame.

SPECIFY:

1. Model number
2. Frame finish
3. Upholstery selection
4. Options, as applicable

ORDERING EXAMPLE:

#M4915-BC01-MB01

Armless Guest Chair, Wood
Frame
Replaceable Back Cover
Moisture Barrier

HAVEN GUEST-TANDEM

designed by david dahl



SIN #711-17

MODEL NUMBER	PRODUCT SPECIFICATIONS		FABRIC GRADES										LEATHER GRADES				
			COM	1	2	COL			4	5	6	7	8	L1	L2	L3	
4915 M4915 (METAL FRAME) 	Guest Chair, Armless W 24 ¹ / ₂ D 25 ³ / ₄ H 34 Seat Height 18 Inside Seat Width 21 Inside Seat Depth 18 ¹ / ₂ 1 ³ / ₄ Yds. 34 lbs. TB 133, add \$84 List	Wood Frame	1024	1124	1148	1190	1232	1273	1315	1353	1396	1589	1730	1868			
		Metal Frame	994	1094	1118	1160	1202	1243	1285	1323	1366	1559	1700	1838			

OPTIONS (XXXX - REFERS TO CHAIR MODEL NUMBER)

MODEL	DESCRIPTION	LIST
XXXX-SC01	Replaceable Seat Cover (per unit)	45
XXXX-BC01	Replaceable Back Cover (per unit)	30
XXXX-MB01	Moisture Barrier (seat only, per unit)	50
XXXX-NS02B	Non-Skid Glides (per unit)	20

HAVEN GUEST-TANDEM

designed by david dahl



NOTES:

- Connecting tables for pre-configured tandem units and configurable modular units.
- Custom sizes available, contact Customer Service for pricing.
- Tables are Beech veneer with hardwood edge.
- For Corian top, specify “-CO” next to model number.
- Beech veneer and laminate tops are 3/4" thick. Corian tops are 1/2" thick.
- Tables are field installed.

SPECIFY:

1. Model number
2. Table top finish
3. Leg finish, as applicable
4. Options, as applicable







Due to the directional nature of connecting tables, a drawing or sketch must be provided with each order.

ORDERING EXAMPLE:

#4918-15-NS02A

15" Wide End Table, Wood Frame
Non-Skid Glides

SIN #711-17

MODEL NUMBER	PRODUCT SPECIFICATIONS	TABLE TOP FINISH		
		VENEER OR LAMINATE	CORIAN (-CO)	
4917-15 M4917-15 (METAL FRAME UNITS) 	15" Center Table In-Line Add-On W 15 D 21 13 lbs. Field Installed	Wood Frame	593	962
		Metal Frame	576	935
4917-22 M4917-22 (METAL FRAME UNITS) 	22" Center Table In-Line Add-On W 22 D 21 14 lbs. Field Installed	Wood Frame	670	1136
		Metal Frame	650	1103
4918-15 M4918-15 (METAL LEGS) 	15" Wide End Table W 15 D 21 17 lbs. Field Installed	Wood Frame	723	1092
		Metal Frame	701	1061
4918-22 M4918-22 (METAL LEGS) 	22" Wide End Table W 22 D 21 18 lbs. Field Installed	Wood Frame	753	1218
		Metal Frame	730	1184
4919-45 M4919-45 (METAL FRAME UNITS) 	45-Degree Corner Table W 20 D 21 11 lbs. Field Installed	Wood Frame	647	1173
		Metal Frame	627	1140
4919-90 M4919-90 (METAL FRAME UNITS) 	90-Degree Corner Table W 40 D 21 16 lbs. Field Installed	Wood Frame	777	1817
		Metal Frame	754	1764

OPTIONS (XXXX - REFERS TO TABLE MODEL NUMBER)

MODEL	DESCRIPTION	LIST
XXXX-NS02A	Non-Skid Glides (per table)	10

NOTES:

- To build tandem configurations, always specify units from left-to-right as facing.
- Starter units (“-ST”) represent the first seating model in a configuration with subsequent modular units building onto them towards the right.
- Add-On units (“-AO”) can only be added next to Starter units or other Add-On units.
- End-units (“-EU”) represent the final seating model in a configuration.
- Center and corner tables are for in-line placement only (cannot start or end a configuration) and for specification purposes, will always come before a Starter unit or after an End unit (i.e. Add-On units cannot be specified next to connecting tables).
- End tables can only start or end a configuration, therefore they will always come before a Starter unit or after an End unit (i.e. Add-On units cannot be specified next to connecting tables).
- For Corian arm caps, please specify “-CO” in place of the “-W” after model number (with color selection) and refer to options below for upcharge.

HAVEN GUEST-TANDEM

designed by david dahl

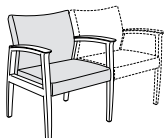
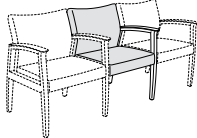
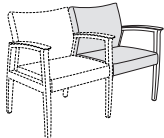

SIN #711-17

MODEL NUMBER	PRODUCT SPECIFICATIONS	FABRIC GRADES							LEATHER GRADES					
		COM	1	2	COL 3	4	5	6	7	8	L1	L2	L3	
4920-ST-W M4920-ST-W (METAL FRAME) 	Tandem Starter Unit Wood Arm Caps W 25 D 25 ³ / ₄ H 34 Seat Height 18 Inside Seat Width 21 Inside Seat Depth 18 ¹ / ₂ Arm Height 25 ³ / ₄ 1 ³ / ₄ Yds. 39 lbs. TB 133, add \$84 List	Wood Frame	1137	1237	1261	1303	1345	1386	1428	1466	1509	1702	1843	1981
		Metal Frame	1103	1203	1227	1269	1311	1352	1394	1432	1475	1668	1809	1947
4920-AO-W M4920-AO-W (METAL FRAME) 	Tandem Add-On Unit Wood Arm Cap W 23 D 25 ³ / ₄ H 34 Seat Height 18 Inside Seat Width 21 Inside Seat Depth 18 ¹ / ₂ Arm Height 25 ³ / ₄ 1 ³ / ₄ Yds. 34 lbs. TB 133, add \$84 List	Wood Frame	891	991	1015	1057	1099	1140	1182	1220	1263	1456	1597	1735
		Metal Frame	865	965	989	1031	1073	1114	1156	1194	1237	1430	1571	1709
4920-EU-W M4920-EU-W (METAL FRAME) 	Tandem End Unit Wood Arm Cap W 23 ¹ / ₂ D 25 ³ / ₄ H 34 Seat Height 18 Inside Seat Width 21 Inside Seat Depth 18 ¹ / ₂ Arm Height 25 ³ / ₄ 1 ³ / ₄ Yds. 34 lbs. TB 133, add \$84 List	Wood Frame	891	991	1015	1057	1099	1140	1182	1220	1263	1456	1597	1735
		Metal Frame	865	965	989	1031	1073	1114	1156	1194	1237	1430	1571	1709
-PA	Upholstered Inset Panel Arm (wood or metal frame, per arm) 1/2 Yd. TB 133, add \$24 List per arm		96	125	132	144	156	167	179	190	203	258	298	337

Connecting Tables Page 6
 In-Line Benches Page 11
 Bariatric Models Pages 12-16

OPTIONS (XXXX - REFERS TO CHAIR MODEL NUMBER)

MODEL	DESCRIPTION	LIST
XXXX-CO	Corian Arm Caps (per arm)	50
XXXX-SC01	Replaceable Seat Cover (per seat)	45
XXXX-BC01	Replaceable Back Cover (per back)	30
XXXX-MB01	Moisture Barrier (seat only, per seat)	50
XXXX-NS02A	Non-Skid Glides (per arm frame)	10

HAVEN GUEST-TANDEM

designed by david dahl



NOTES:

- To build tandem configurations, always specify units from left-to-right as facing.
- Starter units (“-ST”) represent the first seating model in a configuration with subsequent modular units building onto them towards the right.
- Add-On units (“-AO”) can only be added next to Starter units or other Add-On units.
- End-units (“-EU”) represent the final seating model in a configuration.
- Center and corner tables are for in-line placement only (cannot start or end a configuration) and for specification purposes, will always come before a Starter unit or after an End unit (i.e. Add-On units cannot be specified next to connecting tables).
- End tables can only start or end a configuration, therefore they will always come before a Starter unit or after an End unit (i.e. Add-On units cannot be specified next to connecting tables).

SIN #711-17

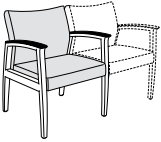
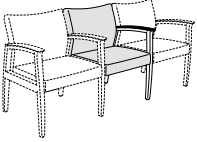
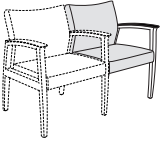
MODEL NUMBER	PRODUCT SPECIFICATIONS	FABRIC GRADES							LEATHER GRADES					
		COM	1	2	COL			8	L1	L2	L3			
4920-ST-U M4920-ST-U (METAL FRAME) 	Tandem Starter Unit Black Urethane Arm Caps W 25 D 25 ³ / ₄ H 34 Seat Height 18 Inside Seat Width 21 Inside Seat Depth 18 ¹ / ₂ Arm Height 25 ³ / ₄ 1 ³ / ₄ Yds. 39 lbs. TB 133, add \$84 List	Wood Frame	1137	1237	1261	1303	1345	1386	1428	1466	1509	1702	1843	1981
		Metal Frame	1103	1203	1227	1269	1311	1352	1394	1432	1475	1668	1809	1947
4920-AO-U M4920-AO-U (METAL FRAME) 	Tandem Add-On Unit Black Urethane Arm Cap W 23 D 25 ³ / ₄ H 34 Seat Height 18 Inside Seat Width 21 Inside Seat Depth 18 ¹ / ₂ Arm Height 25 ³ / ₄ 1 ³ / ₄ Yds. 34 lbs. TB 133, add \$84 List	Wood Frame	891	991	1015	1057	1099	1140	1182	1220	1263	1456	1597	1735
		Metal Frame	865	965	989	1031	1073	1114	1156	1194	1237	1430	1571	1709
4920-EU-U M4920-EU-U (METAL FRAME) 	Tandem End Unit Black Urethane Arm Cap W 23 ¹ / ₂ D 25 ³ / ₄ H 34 Seat Height 18 Inside Seat Width 21 Inside Seat Depth 18 ¹ / ₂ Arm Height 25 ³ / ₄ 1 ³ / ₄ Yds. 34 lbs. TB 133, add \$84 List	Wood Frame	891	991	1015	1057	1099	1140	1182	1220	1263	1456	1597	1735
		Metal Frame	865	965	989	1031	1073	1114	1156	1194	1237	1430	1571	1709
-PA	Upholstered Inset Panel Arm (wood or metal frame, per arm) 1 ¹ / ₂ Yd. TB 133, add \$24 List per arm		96	125	132	144	156	167	179	190	203	258	298	337

Connecting Tables Page 6
 In-Line Benches Page 11
 Bariatric Models Pages 12-16

OPTIONS (XXXX - REFERS TO CHAIR MODEL NUMBER)

MODEL	DESCRIPTION	LIST
XXXX-SC01	Replaceable Seat Cover (per seat)	45
XXXX-BC01	Replaceable Back Cover (per back)	30
XXXX-MB01	Moisture Barrier (seat only, per seat)	50
XXXX-NS02A	Non-Skid Glides (per arm frame)	10

NOTES:

- To build tandem configurations, always specify units from left-to-right as facing.
- Starter units (“-ST”) represent the first seating model in a configuration with subsequent modular units building onto them towards the right.
- Add-On units (“-AO”) can only be added next to Starter units or other Add-On units.
- End-units (“-EU”) represent the final seating model in a configuration.
- Center and corner tables are for in-line placement only (cannot start or end a configuration) and for specification purposes, will always come before a Starter unit or after an End unit (i.e. Add-On units cannot be specified next to connecting tables).
- End tables can only start or end a configuration, therefore they will always come before a Starter unit or after an End unit (i.e. Add-On units cannot be specified next to connecting tables).
- For Corian arm caps, please specify “-CO” in place of the “-W” after model number (with color selection) and refer to options below for upcharge.

HAVEN GUEST-TANDEM

designed by david dahl

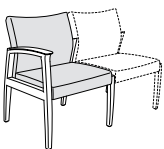
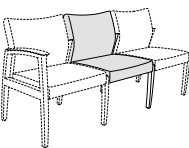
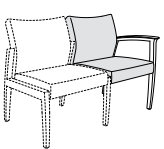

SIN #711-17

MODEL NUMBER	PRODUCT SPECIFICATIONS	FABRIC GRADES							LEATHER GRADES					
		COM	1	2	COL 3	4	5	6	7	8	L1	L2	L3	
4925-ST-W M4925-ST-W (METAL FRAME) 	Tandem Starter Unit Wood Arm Cap/Armless W 24 ¹ / ₂ D 25 ³ / ₄ H 34 Seat Height 18 Inside Seat Width 21 Inside Seat Depth 18 ¹ / ₂ Arm Height 25 ³ / ₄ 1 ³ / ₄ Yds. 35 lbs. TB 133, add \$84 List	Wood Frame	1101	1201	1225	1267	1309	1350	1392	1430	1473	1666	1807	1945
		Metal Frame	1068	1168	1192	1234	1276	1317	1359	1397	1440	1633	1774	1912
4925-AO M4925-AO (METAL FRAME) 	Tandem Add-On Unit Armless/Armless W 23 D 25 ³ / ₄ H 34 Seat Height 18 Inside Seat Width 21 Inside Seat Depth 18 ¹ / ₂ 1 ³ / ₄ Yds. 33 lbs. TB 133, add \$84 List	Wood Frame	813	913	937	979	1021	1062	1104	1142	1185	1378	1519	1657
		Metal Frame	789	889	913	955	997	1038	1080	1118	1161	1354	1495	1633
4925-EU-W M4925-EU-W (METAL FRAME) 	Tandem End Unit Armless/Wood Arm Cap W 24 ¹ / ₂ D 25 ³ / ₄ H 34 Seat Height 18 Inside Seat Width 21 Inside Seat Depth 18 ¹ / ₂ Arm Height 25 ³ / ₄ 1 ³ / ₄ Yds. 35 lbs. TB 133, add \$84 List	Wood Frame	1101	1201	1225	1267	1309	1350	1392	1430	1473	1666	1807	1945
		Metal Frame	1068	1168	1192	1234	1276	1317	1359	1397	1440	1633	1774	1912
-PA	Upholstered Inset Panel Arm (wood or metal frame, per arm) 1/2 Yd. TB 133, add \$24 List per arm		96	125	132	144	156	167	179	190	203	258	298	337

Connecting Tables Page 6
 In-Line Benches Page 11
 Bariatric Models Pages 12-16

OPTIONS (XXXX - REFERS TO CHAIR MODEL NUMBER)

MODEL	DESCRIPTION	LIST
XXXX-CO	Corian Arm Caps (per arm)	50
XXXX-SC01	Replaceable Seat Cover (per seat)	45
XXXX-BC01	Replaceable Back Cover (per back)	30
XXXX-MB01	Moisture Barrier (seat only, per seat)	50
XXXX-NS02A	Non-Skid Glides (per arm frame)	10

HAVEN GUEST-TANDEM

designed by david dahl



NOTES:

- To build tandem configurations, always specify units from left-to-right as facing.
- Starter units (“-ST”) represent the first seating model in a configuration with subsequent modular units building onto them towards the right.
- Add-On units (“-AO”) can only be added next to Starter units or other Add-On units.
- End-units (“-EU”) represent the final seating model in a configuration.
- Center and corner tables are for in-line placement only (cannot start or end a configuration) and for specification purposes, will always come before a Starter unit or after an End unit (i.e. Add-On units cannot be specified next to connecting tables).
- End tables can only start or end a configuration, therefore they will always come before a Starter unit or after an End unit (i.e. Add-On units cannot be specified next to connecting tables).

SIN #711-17

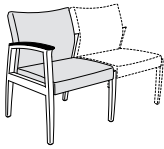
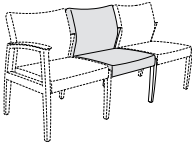
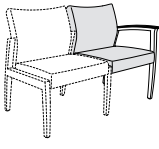
MODEL NUMBER	PRODUCT SPECIFICATIONS	FABRIC GRADES							LEATHER GRADES								
		COM	1	2	COL			3	4	5	6	7	8	L1	L2	L3	
4925-ST-U M4925-ST-U (METAL FRAME) 	Tandem Starter Unit Black Urethane Arm Cap/Armless W 24 ¹ / ₂ D 25 ³ / ₄ H 34 Seat Height 18 Inside Seat Width 21 Inside Seat Depth 18 ¹ / ₂ Arm Height 25 ³ / ₄ 1 ³ / ₄ Yds. 35 lbs. TB 133, add \$84 List	Wood Frame	1101	1201	1225	1267	1309	1350	1392	1430	1473	1666	1807	1945			
		Metal Frame	1068	1168	1192	1234	1276	1317	1359	1397	1440	1633	1774	1912			
4925-AO M4925-AO (METAL FRAME) 	Tandem Add-On Unit Armless/Armless W 23 D 25 ³ / ₄ H 34 Seat Height 18 Inside Seat Width 21 Inside Seat Depth 18 ¹ / ₂ 1 ³ / ₄ Yds. 33 lbs. TB 133, add \$84 List	Wood Frame	813	913	937	979	1021	1062	1104	1142	1185	1378	1519	1657			
		Metal Frame	789	889	913	955	997	1038	1080	1118	1161	1354	1495	1633			
4925-EU-U M4925-EU-U (METAL FRAME) 	Tandem End Unit Armless/Black Urethane Arm Cap W 24 ¹ / ₂ D 25 ³ / ₄ H 34 Seat Height 18 Inside Seat Width 21 Inside Seat Depth 18 ¹ / ₂ Arm Height 25 ³ / ₄ 1 ³ / ₄ Yds. 35 lbs. TB 133, add \$84 List	Wood Frame	1101	1201	1225	1267	1309	1350	1392	1430	1473	1666	1807	1945			
		Metal Frame	1068	1168	1192	1234	1276	1317	1359	1397	1440	1633	1774	1912			
-PA	Upholstered Inset Panel Arm (wood or metal frame, per arm) 1 ¹ / ₂ Yd. TB 133, add \$24 List per arm		96	125	132	144	156	167	179	190	203	258	298	337			

Connecting Tables Page 6
 In-Line Benches Page 11
 Bariatric Models Pages 12-16

OPTIONS (XXXX - REFERS TO CHAIR MODEL NUMBER)

MODEL	DESCRIPTION	LIST
XXXX-SC01	Replaceable Seat Cover (per seat)	45
XXXX-BC01	Replaceable Back Cover (per back)	30
XXXX-MB01	Moisture Barrier (seat only, per seat)	50
XXXX-NS02A	Non-Skid Glides (per arm frame)	10

NOTES:

- To build tandem configurations, always specify units from left-to-right as facing.
- In-Line Bench models cannot start or end a run, i.e. they must be added to any Starter or Add-On seating unit.
- In-Line Bench models must be positioned next to modular chair units only (cannot be adjoined with another in-line bench or connecting table).
- In-line benches standard with one arm.
- Upholstered inset panel arm available. Please add “-PA” to model number and refer to page 10 for yardage requirements and pricing.
- For Corian arm caps, please specify “-CO” in place of the “-W” after model number (with color selection) and refer to options below for upcharge.

HAVEN GUEST-TANDEM

designed by david dahl

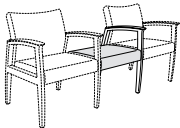
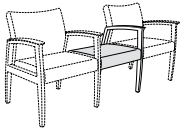
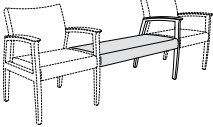
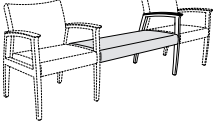

SIN #711-17

MODEL NUMBER	PRODUCT SPECIFICATIONS	FABRIC GRADES							LEATHER GRADES								
		COM	1	2	COL			3	4	5	6	7	8	L1	L2	L3	
4927-AO-W M4927-AO-W (METAL FRAME) 	21" Wide In-Line Bench Single Arm, Wood Arm Cap W 21 D 18 Seat Height 18 Inside Seat Width 21 Inside Seat Depth 18 ¹ / ₂ Arm Height 25 ³ / ₄ 1 Yd. 25 lbs. TB 133, add \$48 List	Wood Frame	695	752	766	790	814	837	861	883	908	1018	1099	1177			
		Metal Frame	674	731	745	769	793	816	840	862	887	997	1078	1156			
4927-AO-U M4927-AO-U (METAL FRAME) 	21" Wide In-Line Bench Single Arm, Urethane Arm Cap W 21 D 18 Seat Height 18 Inside Seat Width 21 Inside Seat Depth 18 ¹ / ₂ Arm Height 25 ³ / ₄ 1 Yd. 25 lbs. TB 133, add \$48 List	Wood Frame	695	752	766	790	814	837	861	883	908	1018	1099	1177			
		Metal Frame	674	731	745	769	793	816	840	862	887	997	1078	1156			
4928-AO-W M4928-AO-W (METAL FRAME) 	42" Wide In-Line Bench Single Arm, Wood Arm Cap W 42 D 18 Seat Height 18 Inside Seat Width 42 Inside Seat Depth 18 ¹ / ₂ Arm Height 25 ³ / ₄ 1 ¹ / ₂ Yds. 42 lbs. TB 133, add \$72 List	Wood Frame	933	1019	1039	1075	1111	1146	1182	1215	1252	1417	1538	1656			
		Metal Frame	906	992	1012	1048	1084	1119	1155	1188	1225	1390	1511	1629			
4928-AO-U M4928-AO-U (METAL FRAME) 	42" Wide In-Line Bench Single Arm, Urethane Arm Cap W 42 D 18 Seat Height 18 Inside Seat Width 42 Inside Seat Depth 18 ¹ / ₂ Arm Height 25 ³ / ₄ 1 ¹ / ₂ Yds. 42 lbs. TB 133, add \$72 List	Wood Frame	933	1019	1039	1075	1111	1146	1182	1215	1252	1417	1538	1656			
		Metal Frame	906	992	1012	1048	1084	1119	1155	1188	1225	1390	1511	1629			

Tandem Seating Pages 7-10
 Connecting Tables Page 6
 Bariatric Models Pages 12-16

OPTIONS (XXXX - REFERS TO CHAIR MODEL NUMBER)

MODEL	DESCRIPTION	LIST
XXXX-CO	Corian Arm Caps (per arm)	50
XXXX-SC01	21" Wide Replaceable Seat Cover (per seat)	45
XXXX-SC02	42" Wide Replaceable Seat Cover (per seat)	60
XXXX-MB01	Moisture Barrier (seat only, per seat)	50
XXXX-NS02A	Non-Skid Glides (per arm frame)	10

HAVEN GUEST-TANDEM

designed by david dahl



SIN #711-17

NOTES:

- Beech hardwood or metal frame.
- 750 lb. maximum seat capacity.
- Upholstered inset panel arm available. Please add “-PA” to model number and refer to page 10 for yardage requirements and pricing.
- Three arm cap options: Beech wood, black urethane or Corian.
- For Corian arm caps, please specify “-CO” in place of the “-W” after model number (with color selection) and refer to options below for upcharge.
- Refer to page 24 for two-tone upholstery examples and yardage requirements.

SPECIFY:

1. Model number
2. Frame finish
3. Arm cap finish, as applicable
4. Upholstery selection
5. Options, as applicable

ORDERING EXAMPLE:

#M4940-U-MB02-NS02B

34" Wide Bariatric Settee,
Metal Frame
Black Urethane Arm Caps
Moisture Barrier
Non-Skid Glides

MODEL NUMBER	PRODUCT SPECIFICATIONS	FABRIC GRADES							LEATHER GRADES					
		COM	1	2	COL			8	L1	L2	L3			
4940-W M4940-W (METAL FRAME)	Bariatric Settee, 34" Wide Wood Arm Caps W 34 D 25 ³ / ₄ H 34 Seat Height 18 Inside Seat Width 30 Inside Seat Depth 18 Arm Height 26 ¹ / ₂ 2 ¹ / ₂ Yds. 51 lbs. TB 133, add \$120 List	Wood Frame	1507	1649	1683	1744	1804	1862	1922	1977	2038	2313	2515	2712
		Metal Frame	1462	1604	1638	1699	1759	1817	1877	1932	1993	2268	2470	2667
4940-U M4940-U (METAL FRAME)	Bariatric Settee, 34" Wide Black Urethane Arm Caps W 34 D 25 ³ / ₄ H 34 Seat Height 18 Inside Seat Width 30 Inside Seat Depth 18 Arm Height 26 ¹ / ₂ 2 ¹ / ₂ Yds. 51 lbs. TB 133, add \$120 List	Wood Frame	1507	1649	1683	1744	1804	1862	1922	1977	2038	2313	2515	2712
		Metal Frame	1462	1604	1638	1699	1759	1817	1877	1932	1993	2268	2470	2667
4945-W M4945-W (METAL FRAME)	Bariatric Settee, 40" Wide Wood Arm Caps W 40 D 25 ³ / ₄ H 34 Seat Height 18 Inside Seat Width 36 Inside Seat Depth 18 Arm Height 26 ¹ / ₂ 3 Yds. 75 lbs. TB 133, add \$144 List	Wood Frame	1725	1896	1937	2009	2081	2151	2223	2289	2362	2693	2935	3171
		Metal Frame	1674	1845	1886	1958	2030	2100	2172	2238	2311	2642	2884	3120
4945-U M4945-U (METAL FRAME)	Bariatric Settee, 40" Wide Black Urethane Arm Caps W 40 D 25 ³ / ₄ H 34 Seat Height 18 Inside Seat Width 36 Inside Seat Depth 18 Arm Height 26 ¹ / ₂ 3 Yds. 75 lbs. TB 133, add \$144 List	Wood Frame	1725	1896	1937	2009	2081	2151	2223	2289	2362	2693	2935	3171
		Metal Frame	1674	1845	1886	1958	2030	2100	2172	2238	2311	2642	2884	3120

OPTIONS (XXXX - REFERS TO CHAIR MODEL NUMBER)

MODEL	DESCRIPTION	LIST
XXXX-CO	Corian Arm Caps	100
XXXX-SC02	Replaceable Seat Cover (per unit)	60
XXXX-BC02	Replaceable Back Cover (per unit)	45
XXXX-MB02	Moisture Barrier (seat only, per unit)	95
XXXX-NS02B	Non-Skid Glides (per unit)	20

NOTES:

- To build tandem configurations, always specify units from left-to-right as facing.
- Starter units (“-ST”) represent the first seating model in a configuration with subsequent modular units building onto them towards the right.
- Bariatric Add-On units (“-AO”) can only be added next to non-bariatric Tandem Seating Starter and Add-On units as well as In-Line Benches (two bariatric chairs cannot be adjoined together side-by-side).
- End-units (“-EU”) represent the final seating model in a configuration.
- Center and corner tables are for in-line placement only (cannot start or end a configuration) and for specification purposes, will always come before a Starter unit or after an End unit (i.e. Add-On units cannot be specified next to connecting tables).
- End tables can only start or end a configuration, therefore they will always come before a Starter unit or after an End unit (i.e. Add-On units cannot be specified next to connecting tables).
- **Bariatric tandem chairs cannot be adjoined together side-by-side.**
- For Corian arm caps, please specify “-CO” in place of the “-W” after model number (with color selection) and refer to options below for upcharge.

HAVEN GUEST-TANDEM

designed by david dahl

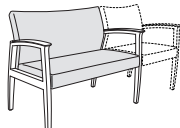
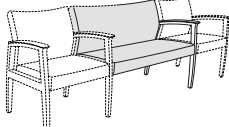
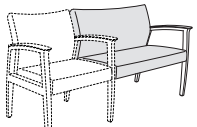

SIN #711-17

MODEL NUMBER	PRODUCT SPECIFICATIONS	FABRIC GRADES							LEATHER GRADES					
		COM	1	2	COL			4	5	6	7	8	L1	L2
4940-ST-W M4940-ST-W (METAL FRAME) 	Tandem Bariatric Starter Unit 34" Wide, Wood Arm Caps W 34 D 25 ³ / ₄ H 34 Seat Height 18 Inside Seat Width 30 Inside Seat Depth 18 Arm Height 26 ¹ / ₂ 2 ¹ / ₂ Yds. 51 lbs. TB 133, add \$120 List	Wood Frame	1526	1668	1702	1763	1823	1881	1941	1996	2057	2332	2534	2731
		Metal Frame	1482	1624	1658	1719	1779	1837	1897	1952	2013	2288	2490	2687
4940-AO-W M4940-AO-W (METAL FRAME) 	Tandem Bariatric Add-On Unit 34" Wide, Wood Arm Cap W 32 D 25 ³ / ₄ H 34 Seat Height 18 Inside Seat Width 30 Inside Seat Depth 18 Arm Height 26 ¹ / ₂ 2 ¹ / ₂ Yds. 47 lbs. TB 133, add \$120 List	Wood Frame	1304	1446	1480	1541	1601	1659	1719	1774	1835	2110	2312	2509
		Metal Frame	1266	1408	1442	1503	1563	1621	1681	1736	1797	2072	2274	2471
4940-EU-W M4940-EU-W (METAL FRAME) 	Tandem Bariatric End Unit 34" Wide, Wood Arm Cap W 32 ¹ / ₂ D 25 ³ / ₄ H 34 Seat Height 18 Inside Seat Width 30 Inside Seat Depth 18 Arm Height 26 ¹ / ₂ 2 ¹ / ₂ Yds. 47 lbs. TB 133, add \$120 List	Wood Frame	1304	1446	1480	1541	1601	1659	1719	1774	1835	2110	2312	2509
		Metal Frame	1266	1408	1442	1503	1563	1621	1681	1736	1797	2072	2274	2471
-PA	Upholstered Inset Panel Arm (wood or metal frame, per arm) 1 ¹ / ₂ Yd. TB 133, add \$24 List per arm		96	125	132	144	156	167	179	190	203	258	298	337

Connecting Tables Page 6
Tandem Seating Pages 7-10
In-Line Benches Page 11

OPTIONS (XXXX - REFERS TO CHAIR MODEL NUMBER)

MODEL	DESCRIPTION	LIST
XXXX-CO	Corian Arm Caps (per arm)	50
XXXX-SC02	Replaceable Seat Cover (per seat)	60
XXXX-BC02	Replaceable Back Cover (per back)	45
XXXX-MB02	Moisture Barrier (seat only, per seat)	95
XXXX-NS02A	Non-Skid Glides (per arm frame)	10

HAVEN GUEST-TANDEM

designed by david dahl



NOTES:

- To build tandem configurations, always specify units from left-to-right as facing.
- Starter units (“-ST”) represent the first seating model in a configuration with subsequent modular units building onto them towards the right.
- Bariatric Add-On units (“-AO”) can only be added next to **non-bariatric** Tandem Seating Starter and Add-On units as well as In-Line Benches (two bariatric chairs cannot be adjoined together side-by-side).
- End-units (“-EU”) represent the final seating model in a configuration.
- Center and corner tables are for in-line placement only (cannot start or end a configuration) and for specification purposes, will always come before a Starter unit or after an End unit (i.e. Add-On units cannot be specified next to connecting tables).
- End tables can only start or end a configuration, therefore they will always come before a Starter unit or after an End unit (i.e. Add-On units cannot be specified next to connecting tables).
- **Bariatric tandem chairs cannot be adjoined together side-by-side.**

SIN #711-17

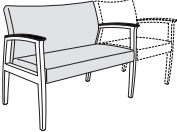
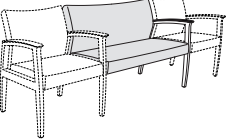
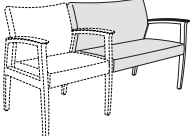
MODEL NUMBER	PRODUCT SPECIFICATIONS	FABRIC GRADES							LEATHER GRADES					
		COM	1	2	COL			8	L1	L2	L3			
4940-ST-U M4940-ST-U (METAL FRAME) 	Tandem Bariatric Starter Unit 34" Wide, Black Urethane Arm Caps W 34 D 25 ³ / ₄ H 34 Seat Height 18 Inside Seat Width 30 Inside Seat Depth 18 Arm Height 26 ¹ / ₂ 2 ¹ / ₂ Yds. 51 lbs. TB 133, add \$120 List	Wood Frame	1526	1668	1702	1763	1823	1881	1941	1996	2057	2332	2534	2731
		Metal Frame	1482	1624	1658	1719	1779	1837	1897	1952	2013	2288	2490	2687
4940-AO-U M4940-AO-U (METAL FRAME) 	Tandem Bariatric Add-On Unit 34" Wide, Black Urethane Arm Cap W 32 D 25 ³ / ₄ H 34 Seat Height 18 Inside Seat Width 30 Inside Seat Depth 18 Arm Height 26 ¹ / ₂ 2 ¹ / ₂ Yds. 47 lbs. TB 133, add \$120 List	Wood Frame	1304	1446	1480	1541	1601	1659	1719	1774	1835	2110	2312	2509
		Metal Frame	1266	1408	1442	1503	1563	1621	1681	1736	1797	2072	2274	2471
4940-EU-U M4940-EU-U (METAL FRAME) 	Tandem Bariatric End Unit 34" Wide, Black Urethane Arm Cap W 32 ¹ / ₂ D 25 ³ / ₄ H 34 Seat Height 18 Inside Seat Width 30 Inside Seat Depth 18 Arm Height 26 ¹ / ₂ 2 ¹ / ₂ Yds. 47 lbs. TB 133, add \$120 List	Wood Frame	1304	1446	1480	1541	1601	1659	1719	1774	1835	2110	2312	2509
		Metal Frame	1266	1408	1442	1503	1563	1621	1681	1736	1797	2072	2274	2471
-PA	Upholstered Inset Panel Arm (wood or metal frame, per arm) 1/2 Yd. TB 133, add \$24 List per arm		96	125	132	144	156	167	179	190	203	258	298	337

Connecting Tables Page 6
 Tandem Seating Pages 7-10
 In-Line Benches Page 11

OPTIONS (XXXX - REFERS TO CHAIR MODEL NUMBER)

MODEL	DESCRIPTION	LIST
XXXX-SC02	Replaceable Seat Cover (per seat)	60
XXXX-BC02	Replaceable Back Cover (per back)	45
XXXX-MB02	Moisture Barrier (seat only, per seat)	95
XXXX-NS02A	Non-Skid Glides (per arm frame)	10

NOTES:

- To build tandem configurations, always specify units from left-to-right as facing.
- Starter units (“-ST”) represent the first seating model in a configuration with subsequent modular units building onto them towards the right.
- Bariatric Add-On units (“-AO”) can only be added next to non-bariatric Tandem Seating Starter and Add-On units as well as In-Line Benches (two bariatric chairs cannot be adjoined together side-by-side).
- End-units (“-EU”) represent the final seating model in a configuration.
- Center and corner tables are for in-line placement only (cannot start or end a configuration) and for specification purposes, will always come before a Starter unit or after an End unit (i.e. Add-On units cannot be specified next to connecting tables).
- End tables can only start or end a configuration, therefore they will always come before a Starter unit or after an End unit (i.e. Add-On units cannot be specified next to connecting tables).
- **Bariatric tandem chairs cannot be adjoined together side-by-side.**
- For Corian arm caps, please specify “-CO” in place of the “-W” after model number (with color selection) and refer to options below for upcharge.

HAVEN GUEST-TANDEM

designed by david dahl

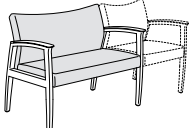
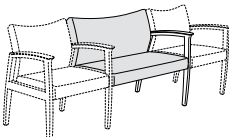
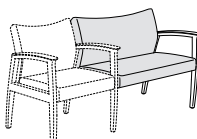

SIN #711-17

MODEL NUMBER	PRODUCT SPECIFICATIONS	FABRIC GRADES								LEATHER GRADES				
		COM	1	2	COL			4	5	6	7	8	L1	L2
4945-ST-W M4945-ST-W (METAL FRAME)	 <p>Tandem Bariatric Starter Unit 40" Wide, Wood Arm Caps W 40 D 25³/₄ H 34 Seat Height 18 Inside Seat Width 36 Inside Seat Depth 18 Arm Height 26¹/₂ 3 Yds. 75 lbs. TB 133, add \$144 List</p>	Wood Frame	1728	1899	1940	2012	2084	2154	2226	2292	2365	2696	2938	3174
		Metal Frame	1676	1847	1888	1960	2032	2102	2174	2240	2313	2644	2886	3122
4945-AO-W M4945-AO-W (METAL FRAME)	 <p>Tandem Bariatric Add-On Unit 40" Wide, Wood Arm Cap W 38 D 25³/₄ H 34 Seat Height 18 Inside Seat Width 36 Inside Seat Depth 18 Arm Height 26¹/₂ 3 Yds. 71 lbs. TB 133, add \$144 List</p>	Wood Frame	1518	1689	1730	1802	1874	1944	2016	2082	2155	2486	2728	2964
		Metal Frame	1473	1644	1685	1757	1829	1899	1971	2037	2110	2441	2683	2919
4945-EU-W M4945-EU-W (METAL FRAME)	 <p>Tandem Bariatric End Unit 40" Wide, Wood Arm Cap W 38¹/₂ D 25³/₄ H 34 Seat Height 18 Inside Seat Width 36 Inside Seat Depth 18 Arm Height 26¹/₂ 3 Yds. 71 lbs. TB 133, add \$144 List</p>	Wood Frame	1518	1689	1730	1802	1874	1944	2016	2082	2155	2486	2728	2964
		Metal Frame	1473	1644	1685	1757	1829	1899	1971	2037	2110	2441	2683	2919
-PA	<p>Upholstered Inset Panel Arm (wood or metal frame, per arm) 1/2 Yd. TB 133, add \$24 List per arm</p> <p>Connecting Tables Page 6 Tandem Seating Pages 7-10 In-Line Benches Page 11</p>		96	125	132	144	156	167	179	190	203	258	298	337

OPTIONS (XXXX - REFERS TO CHAIR MODEL NUMBER)

MODEL	DESCRIPTION	LIST
XXXX-CO	Corian Arm Caps (per arm)	50
XXXX-SC02	Replaceable Seat Cover (per seat)	60
XXXX-BC02	Replaceable Back Cover (per back)	45
XXXX-MB02	Moisture Barrier (seat only, per seat)	95
XXXX-NS02A	Non-Skid Glides (per arm frame)	10

HAVEN GUEST-TANDEM

designed by david dahl



NOTES:

- To build tandem configurations, always specify units from left-to-right as facing.
- Starter units (“-ST”) represent the first seating model in a configuration with subsequent modular units building onto them towards the right.
- Bariatric Add-On units (“-AO”) can only be added next to **non-bariatric** Tandem Seating Starter and Add-On units as well as In-Line Benches (two bariatric chairs cannot be adjoined together side-by-side).
- End-units (“-EU”) represent the final seating model in a configuration.
- Center and corner tables are for in-line placement only (cannot start or end a configuration) and for specification purposes, will always come before a Starter unit or after an End unit (i.e. Add-On units cannot be specified next to connecting tables).
- End tables can only start or end a configuration, therefore they will always come before a Starter unit or after an End unit (i.e. Add-On units cannot be specified next to connecting tables).
- **Bariatric tandem chairs cannot be adjoined together side-by-side.**

SIN #711-17

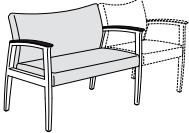
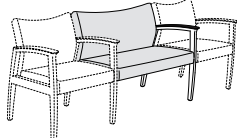
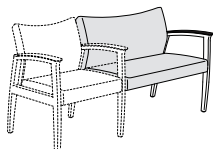
MODEL NUMBER	PRODUCT SPECIFICATIONS	FABRIC GRADES							LEATHER GRADES								
		COM	1	2	COL			3	4	5	6	7	8	L1	L2	L3	
4945-ST-U M4945-ST-U (METAL FRAME) 	Tandem Bariatric Starter Unit 40" Wide, Black Urethane Arm Caps W 40 D 25 ³ / ₄ H 34 Seat Height 18 Inside Seat Width 36 Inside Seat Depth 18 Arm Height 26 ¹ / ₂ 3 Yds. 75 lbs. TB 133, add \$144 List	Wood Frame	1728	1899	1940	2012	2084	2154	2226	2292	2365	2696	2938	3174			
		Metal Frame	1676	1847	1888	1960	2032	2102	2174	2240	2313	2644	2886	3122			
4945-AO-U M4945-AO-U (METAL FRAME) 	Tandem Bariatric Add-On Unit 40" Wide, Black Urethane Arm Cap W 38 D 25 ³ / ₄ H 34 Seat Height 18 Inside Seat Width 36 Inside Seat Depth 18 Arm Height 26 ¹ / ₂ 3 Yds. 71 lbs. TB 133, add \$144 List	Wood Frame	1518	1689	1730	1802	1874	1944	2016	2082	2155	2486	2728	2964			
		Metal Frame	1473	1644	1685	1757	1829	1899	1971	2037	2110	2441	2683	2919			
4945-EU-U M4945-EU-U (METAL FRAME) 	Tandem Bariatric End Unit 40" Wide, Black Urethane Arm Cap W 38 ¹ / ₂ D 25 ³ / ₄ H 34 Seat Height 18 Inside Seat Width 36 Inside Seat Depth 18 Arm Height 26 ¹ / ₂ 3 Yds. 71 lbs. TB 133, add \$144 List	Wood Frame	1518	1689	1730	1802	1874	1944	2016	2082	2155	2486	2728	2964			
		Metal Frame	1473	1644	1685	1757	1829	1899	1971	2037	2110	2441	2683	2919			
-PA	Upholstered Inset Panel Arm (wood or metal frame, per arm) 1/2 Yd. TB 133, add \$24 List per arm		96	125	132	144	156	167	179	190	203	258	298	337			

Connecting Tables Page 6
 Tandem Seating Pages 7-10
 In-Line Benches Page 11

OPTIONS (XXXX - REFERS TO CHAIR MODEL NUMBER)

MODEL	DESCRIPTION	LIST
XXXX-SC02	Replaceable Seat Cover (per seat)	60
XXXX-BC02	Replaceable Back Cover (per back)	45
XXXX-MB02	Moisture Barrier (seat only, per seat)	95
XXXX-NS02A	Non-Skid Glides (per arm frame)	10

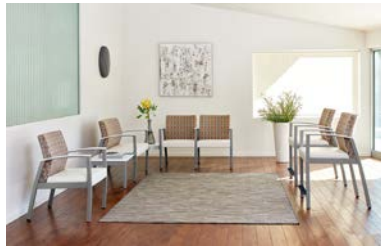
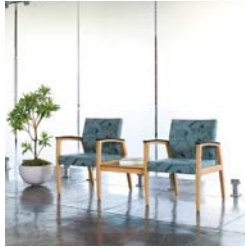

HAVEN GUEST-TANDEM

designed by david dahl



SIN #711-17

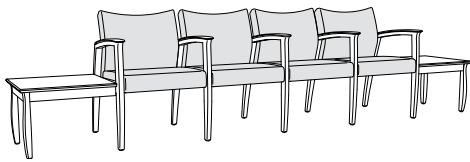

Qty	Model #	Description	COM List
2	4918-22	22" Wide End Table (\$753 List each)	1,506
1	4920-ST-W	Tandem Starter Unit, Wood Arm Caps	1,137
2	4920-AO-W	Tandem Add-On Unit, Wood Arm Cap (\$848 List each)	1,782
<u>1</u>	4920-EU-W	Tandem End Unit, Wood Arm Cap	<u>891</u>
6			5,316

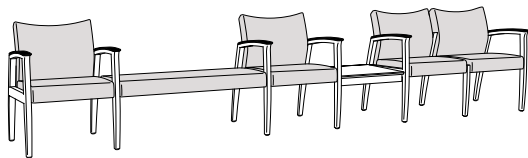

Qty	Model #	Description	COM List
1	4920-ST-U	Tandem Starter Unit, Urethane Arm Caps	1,137
1	4928-AO-U	42" Wide In-Line Bench, Urethane Arm Cap	933
1	4920-EU-U	Tandem End Unit, Urethane Arm Cap	891
1	4917-22	22" Center Table	670
1	4925-ST-U	Tandem Starter Unit, Urethane Arm Cap/Armless	1,101
<u>1</u>	4925-EU-U	Tandem End Unit, Armless/Urethane Arm Cap	<u>1,101</u>
6			5,833

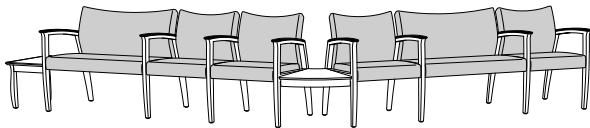

Qty	Model #	Description	COM List
1	M4918-15	15" Wide End Table	701
1	M4945-ST-U	Tandem 40" W Bariatric Starter Unit, Urethane Arm Caps	1,676
1	M4920-AO-U	Tandem Add-On Unit, Urethane Arm Cap	865
2	M4920-EU-U	Tandem End Units, Urethane Arm Cap (\$865 List each)	1,730
1	M4919-45	45-Degree Corner Table	627
1	M4920-ST-U	Tandem Starter Unit, Urethane Arm Cap	1,103
<u>1</u>	M4945-AO-U	Tandem 40" W Bariatric Add-On Unit, Urethane Arm_Cap	<u>1,473</u>
8			8,175

HAVEN GUEST-TANDEM

designed by david dahl



SIN #711-18

NOTES:

- Beech hardwood or metal frame.
- Three arm cap options: Beech wood, black urethane or Corian.
- For Corian arm caps, please specify “-CO” in place of the “-W” after model number (with color selection) and refer to options below for upcharge.
- Refer to page 26 for two-tone upholstery examples and yardage requirements.

SPECIFY:

1. Model number
2. Frame finish
3. Arm cap finish, as applicable
4. Upholstery selection
5. Options, as applicable

ORDERING EXAMPLE:

#4950-W-SC01
Patient Chair, Wood Frame
Replaceable Seat Cover

MODEL NUMBER	PRODUCT SPECIFICATIONS	FABRIC GRADES										LEATHER GRADES		
		COM	1	2	COL			4	5	6	7	8	L1	L2
4950-W M4950-W (METAL FRAME)	Patient Chair Wood Arm Caps W 25 D 25 ³ / ₄ H 44 Seat Height 18 Inside Seat Width 21 Inside Seat Depth 19 Arm Height 26 ¹ / ₂ 2 Yds. 41 lbs. TB 133, add \$96 List	Wood Frame	1270	1384	1411	1459	1508	1554	1602	1646	1695	1915	2077	2234
		Metal Frame	1233	1347	1374	1422	1471	1517	1565	1609	1658	1878	2040	2197
4950-U M4950-U (METAL FRAME)	Patient Chair Black Urethane Arm Caps W 25 D 25 ³ / ₄ H 44 Seat Height 18 Inside Seat Width 21 Inside Seat Depth 19 Arm Height 26 ¹ / ₂ 2 Yds. 41 lbs. TB 133, add \$96 List	Wood Frame	1270	1384	1411	1459	1508	1554	1602	1646	1695	1915	2077	2234
		Metal Frame	1233	1347	1374	1422	1471	1517	1565	1609	1658	1878	2040	2197
-PA	Upholstered Inset Panel Arm (wood or metal frame, per arm) 1/2 Yd. TB 133, add \$23 List per arm		96	125	132	144	156	167	179	190	203	258	298	337

OPTIONS (XXXX - REFERS TO CHAIR MODEL NUMBER)

MODEL	DESCRIPTION	LIST
XXXX-CO	Corian Arm Caps	100
XXXX-SC01	Replaceable Seat Cover (per unit)	45
XXXX-MB01	Moisture Barrier (seat only, per unit)	50
XXXX-NS02B	Non-Skid Glides (per unit)	20

NOTES:

- Beech hardwood or metal frame.
- Three arm cap options: Beech wood, black urethane or Corian.
- For Corian arm caps, please specify “-CO” in place of the “-W” after model number (with color selection) and refer to options below for upcharge.
- Brushed Stainless Steel foot step is positioned 6¹/₂" from the floor.
- Refer to page 26 for two-tone upholstery examples and yardage requirements.

SPECIFY:

1. Model number
2. Frame finish
3. Arm cap finish, as applicable
4. Upholstery selection
5. Options, as applicable

ORDERING EXAMPLE:



#M4957-U-NS02B
 Easy Access/Hip Chair, Metal Frame
 Black Urethane Arm Caps
 Non-Skid Glides

HAVEN GUEST-TANDEM

designed by david dahl



SIN #711-17

MODEL NUMBER	PRODUCT SPECIFICATIONS	FABRIC GRADES										LEATHER GRADES					
		COM	1	2	COL			4	5	6	7	8	L1	L2	L3		
4957-W M4957-W (METAL FRAME) 	Easy Access/Hip Chair, Open Arm Wood Arm Caps W 25 D 25 ³ / ₄ H 40 Seat Height 24 ¹ / ₂ Inside Seat Width 21 Inside Seat Depth 18 ¹ / ₂ Arm Height 32 ³ / ₄ 1 ³ / ₄ Yds. 45 lbs. TB 133, add \$84 List	Wood Frame	1566	1666	1690	1732	1774	1815	1857	1895	1938	2131	2272	2410			
		Metal Frame	1520	1620	1644	1686	1728	1769	1811	1849	1892	2085	2226	2364			
4957-U M4957-U (METAL FRAME) 	Easy Access/Hip Chair, Open Arm Black Urethane Arm Caps W 25 D 25 ³ / ₄ H 40 Seat Height 24 ¹ / ₂ Inside Seat Width 21 Inside Seat Depth 18 ¹ / ₂ Arm Height 32 ³ / ₄ 1 ³ / ₄ Yds. 45 lbs. TB 133, add \$84 List	Wood Frame	1566	1666	1690	1732	1774	1815	1857	1895	1938	2131	2272	2410			
		Metal Frame	1520	1620	1644	1686	1728	1769	1811	1849	1892	2085	2226	2364			
-PA	Upholstered Inset Panel Arm (wood or metal frame, per arm) 1 ¹ / ₂ Yd. TB 133, add \$24 List per arm		96	125	132	144	156	167	179	190	203	258	298	337			

OPTIONS (XXXX - REFERS TO CHAIR MODEL NUMBER)

MODEL	DESCRIPTION	LIST
XXXX-CO	Corian Arm Caps	100
XXXX-SC01	Replaceable Seat Cover (per unit)	45
XXXX-BC01	Replaceable Back Cover (per unit)	30
XXXX-MB01	Moisture Barrier (seat only, per unit)	50
XXXX-NS02B	Non-Skid Glides (per unit)	20

HAVEN GUEST-TANDEM

designed by david dahl



NOTES:

- Concealed velcro attachment.
- Replacement seat and back covers can be easily field installed on previously ordered Haven models with replaceable cover option.
- Haven models originally ordered with standard fixed upholstery can utilize replacement seat and/or back covers, however some upholstery work will be required to remove original upholstery covers.



SPECIFY:

1. Model number
2. Upholstery selection

ORDERING EXAMPLE:

#RBC-4910
Replacement Back Cover

SIN #711-17

MODEL NUMBER	PRODUCT SPECIFICATIONS	FABRIC GRADES							LEATHER GRADES							
		COM	1	2	COL			3	4	5	6	7	8	L1	L2	L3
RSC-4910 	Replacement Upholstered Seat Cover 3/4 Yd. COL 15 Sq. Ft. TB 133, add \$36 List Applies to: 4910/M4910 Guest, Arm 4910/M4910 Tandem 4915/M4915 Guest, Armless 4920/M4920 Tandem 4925/M4925 Tandem 4930/M4930 Tandem 4935/M4935 Tandem 4950/M4950 Patient Chair 4957 Easy Access/Hip Chair	102	145	155	173	191	209	227	243	262	344	405	464			
RBC-4910 	Replacement Upholstered Back Cover 1 1/4 Yds. COL 25 Sq. Ft. TB 133, add \$60 List Applies to: 4910/M4910 Guest, Arm 4910/M4910 Tandem 4915/M4915 Guest, Armless 4920/M4920 Tandem 4925/M4925 Tandem 4930/M4930 Tandem 4935/M4935 Tandem 4957 Easy Access/Hip Chair	116	187	204	235	265	294	324	351	382	519	620	719			

NOTES:

- Concealed velcro attachment.
- Replacement seat and back covers can be easily field installed on previously ordered Haven models with replaceable cover option.
- Haven models originally ordered with standard fixed upholstery can utilize replacement seat and/or back covers, however some upholstery work will be required to remove original upholstery covers.

SPECIFY:

1. Model number
2. Upholstery selection

ORDERING EXAMPLE:





#RSC-4928
 42" Wide In-Line Bench
 Replacement Seat Cover

HAVEN GUEST-TANDEM

designed by david dahl

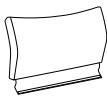

SIN #711-17

MODEL NUMBER	PRODUCT SPECIFICATIONS	FABRIC GRADES								LEATHER GRADES			
		COM	1	2	COL			7	8	L1	L2	L3	
RSC-4927 	21" Wide In-Line Bench Replacement Upholstered Seat Cover 1 Yd. COL 20 Sq. Ft. TB 133, add \$48 List	102	159	173	197	221	244	268	290	315	425	506	584
RSC-4928 	42" Wide In-Line Bench Replacement Upholstered Seat Cover 1 1/2 Yds. COL 30 Sq. Ft. TB 133, add \$72 List	116	202	222	258	294	329	365	398	435	600	721	839
RSC-4940 	34" Wide Bariatric Settee Replacement Upholstered Seat Cover 1 1/4 Yds. COL 25 Sq. Ft. TB 133, add \$60 List	161	232	249	280	310	339	369	396	427	564	665	764
RBC-4940 	34" Wide Bariatric Settee Replacement Upholstered Back Cover 1 3/4 Yds. COL 35 Sq. Ft. TB 133, add \$84 List	161	261	285	327	369	410	452	490	533	726	867	1005
RSC-4945 	40" Wide Bariatric Settee Replacement Upholstered Seat Cover 1 1/2 Yds. COL 30 Sq. Ft. TB 133, add \$72 List	161	247	267	303	339	374	410	443	480	645	766	884
RBC-4945 	40" Wide Bariatric Settee Replacement Upholstered Back Cover 1 3/4 Yds. COL 35 Sq. Ft. TB 133, add \$84 List	161	261	285	327	369	410	452	490	533	726	867	1005

HAVEN GUEST-TANDEM

designed by david dahl



SIN #711-17

NOTES:

- Replacement hardware included with replacement arm frames.



SPECIFY:

1. Model number
2. Arm frame finish

ORDERING EXAMPLE:

#4910-05R-NS02A

Replacement Wood Frame
Non-Skid Glides

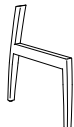
		LIST
<p>4910-05R (WOOD RIGHT ARM, AS SEATED) 4910-05C (WOOD CENTER ARM, AS SEATED) 4910-05L (WOOD LEFT ARM, AS SEATED)</p> 	<p>Replacement Guest Chair Wood Frame, No Arm Cap 9 lbs.</p>	<p>189</p>
<p>4915-05R (WOOD RIGHT ARM, AS SEATED) 4915-05C (WOOD CENTER ARM, AS SEATED) 4915-05L (WOOD LEFT ARM, AS SEATED)</p> 	<p>Replacement Guest Chair Wood Frame, Armless, Center 7 lbs.</p>	<p>172</p>
<p>M4910-05R (METAL RIGHT ARM, AS SEATED) M4910-05C (METAL CENTER ARM, AS SEATED) M4910-05L (METAL LEFT ARM, AS SEATED)</p> 	<p>Replacement Guest Chair Metal Frame, No Arm Cap 9 lbs.</p>	<p>183</p>
<p>M4915-05R (METAL RIGHT ARM, AS SEATED) M4915-05C (METAL CENTER ARM, AS SEATED) M4915-05L (METAL LEFT ARM, AS SEATED)</p> 	<p>Replacement Guest Chair Metal Frame, Armless, Center 7 lbs.</p>	<p>166</p>

OPTIONS (XXXX - REFERS TO COMPONENT MODEL NUMBER)

MODEL	DESCRIPTION	LIST
XXXX-NS02A	Non-Skid Glides (per unit)	10

NOTES:

- Replacement hardware included with replacement arm frames.

SPECIFY:

1. Model number
2. Arm cap finish, as applicable

ORDERING EXAMPLE:



#4910-07U
 Black Urethane Replacement
 Arm Cap

**HAVEN
 GUEST-TANDEM**

designed by david dahl



SIN #711-17

MODEL NUMBER	PRODUCT SPECIFICATIONS	LIST
4910-07W (WOOD) 	Replacement Wood Arm Cap 2 lbs.	62
4910-07U (URETHANE) 	Replacement Black Urethane Arm Cap 2 lbs.	62
4910-07C (CORIAN) 	Replacement Corian Arm Cap (standard colors only) 2 lbs.	129

HAVEN GUEST-TANDEM

designed by david dahl



UPHOLSTERY COMBINATIONS:

For fabric, vinyl or leather upholstery combinations, refer to the pricing below:

- When combining **two** COM/COV/COL fabrics, or fabrics with the same grade, add the following (per unit):
 - › \$45 List for guest, patient and hip chairs
 - › \$65 List for bariatric chairs
- When combining **three or more** COM/COV/COL fabrics, or fabrics with the same grade, add the following (per unit):
 - › \$55 List for guest, patient and hip chairs
 - › \$75 List for bariatric chairs
- When combining different grades of fabric, price will be based on the highest grade specified.
- Two-tone upholstery examples and yardage requirements for the most common combinations are listed below. Additional combinations available, please contact Customer Service for yardage requirements and pricing.
- Note: Yardage amounts are based on fabric which is plain (i.e. non-directional) and a full 54" wide.
- **Appropriate upholstery code must be included on order.**

SIN #711-17



Code	HA1
<u>Models</u>	<u>COM Requirement</u>
All Guest & Easy Access/Hip Units	Seat = $\frac{3}{4}$ yd. Back = $1\frac{1}{4}$ yds.



Code	HA2
<u>Models</u>	<u>COM Requirement</u>
All 34" W Bariatric Units	Seat = $1\frac{1}{4}$ yds. Back = $1\frac{3}{4}$ yds.

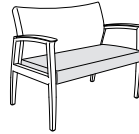

Code	HA3
<u>Models</u>	<u>COM Requirement</u>
All 40" W Bariatric Units	Seat = $1\frac{1}{2}$ yds. Back = $1\frac{3}{4}$ yds.



Code	HA4
<u>Models</u>	<u>COM Requirement</u>
4950-W 4950-U	Seat = $\frac{3}{4}$ yd. Back = 2 yds.



HAVEN LOUNGE

designed by david dahl



SIN #711-16

PRODUCT FEATURES:

- Four arm options: open arm, inset panel arm, upholstered arm or fully upholstered.
- Beech hardwood or metal frame.
- Metal frame available in #06 Charcoal Grey and #90 Metallic Silver. For non-standard options, please contact Customer Service.
- Tandem lounge chairs available as reconfigurable modular units.
- All models feature clean-out area between seat and back.
- Flex back featured on lounge chair models only (love seat and sofa not applicable).
- Open arm, inset panel arm and upholstered arm models available in three arm cap options: Beech wood, black urethane or Corian.
- Corian arm caps available in four standard colors. For non-standard colors, please contact Customer Service for pricing.
- Field-replaceable arm caps available on open arm models.
- All models feature fixed wood legs with 6" height clearance for floor maintenance ease.
- All standard and custom wood finishes available on Beech.
- For custom wood finishes (to frame, arm cap, legs and/or tablet), please add one-time upcharge of \$400 List per color per order.
- Non-skid glides available for hard surface floors. Please specify "-NS02B" after model number and add \$20 List per chair (or \$10 List per arm frame).
- Optional casters available on panel arm and fully upholstered lounge models only, at no upcharge, please specify "-C01" after model number and add \$50 List per unit.
- Caster color is silver as standard.
- Black casters available, please specify.
- Optional replaceable seat cover available on all lounge, loveseat and sofa models. Please specify "-SC02" and add \$60 List per seat.
- Optional replaceable back cover available on lounge chair models only (love seat and sofa not applicable). Please specify "-BC02" and add \$45 List per back.
- Optional pull available on back of lounge chair with casters only. Please specify "-P01" and add \$50 List per unit. Satin nickel finish.
- Please refer to pages 16-18 for two-tone upholstery examples, yardage requirements and pricing.
- All dimensions are nominal.

CORIAN® COLORS:

Designer White
Linen
Rain Cloud
Witch Hazel

Corian® is a registered trademark of Dupont.

HAVEN LOUNGE

designed by david dahl



SIN #711-16

ROTATING TABLET:

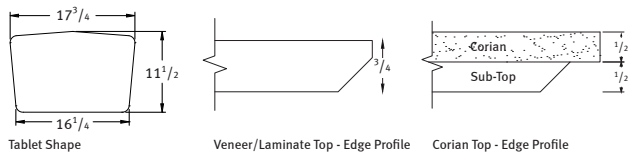

- **Available on upholstered arm and fully upholstered models only.**

- Tablet size is 17³/₄" W x 11¹/₂" D x 3³/₄" thick with 360-degree turning radius.
- Three tablet surface options: Beech veneer, laminate or Corian.
- All standard and custom wood finishes available on Beech.
- For custom wood finishes (to frame, arm cap, legs and/or tablet), please add \$400 List per color per order.
- For standard laminates, refer to Standard Finish Card.
- For custom laminates, add \$500 List per color per order. Pre-approval required, please contact Customer Service.
- Corian available in four standard colors. For non-standard options, please contact Customer Service for pricing.
- For maximum durability, a laminate or Corian surface with a clear coat edge finish is recommended.

TABLET EDGE FINISH SPECIFICATIONS:

- For veneer tops, edge finish will always match the top finish color, unless otherwise specified.
- For standard laminate tops (laminate cannot be applied to the edge):
 - › Wood grain laminates, edge finish will match the laminate top color, unless otherwise specified.
 - › Solid color laminates, edge finish will be natural (clear coat) as standard, unless otherwise specified.
- For Corian tops:
 - › Designer White, Rain Cloud and Linen colors, edge will be white as standard, unless otherwise specified.
 - › Witch Hazel, edge will be natural (clear coat) as standard, unless otherwise specified.
- Edges are also available in all standard wood finishes, please specify. For custom edge finishes, please add one-time upcharge of \$400 List per color, per order.

CUP HOLDER:

- Available on upholstered arm and fully upholstered models only.
- Unless specified, cup holder will be mounted to right side, as seated.
- If specified in conjunction with a tablet, cup holder will be mounted to opposite side unless otherwise specified.
- Dimensions: 4" outer diameter, 3¹/₂" inner diameter (cup size) x 1¹/₄" deep.
- Cup holder finished in #92 Polished Aluminum and features black laminate insert.

HAVEN LOUNGE

designed by david dahl



SIN #711-16

POWER UNITS:

- Unit affixed to right side of seating units, as seated, unless otherwise specified.
- If specified in conjunction with a tablet, power unit will be mounted to same side as tablet unless otherwise specified.
- PB1 and PB2 dimensions: 5³/₄" W x 2¹/₂" D
- PB3 dimensions: 6¹/₂" W x 2¹/₂" D
- Metallic Silver or White finish with 108" electrical cord.
- UL listed.

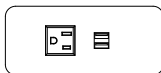

PB1

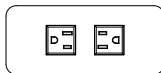

PB2

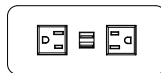

PB3

- PB1 unit features one outlet and two USB charging ports.
- PB2 unit features two outlets.
- PB3 unit features two outlets and two USB charging ports.

TANDEM CONFIGURATIONS:

- To build tandem configurations, always specify units from left-to-right as facing.
- Starter units ("-ST") represent the first seating model in a configuration with subsequent modular units building onto them towards the right.
- Add-On units ("-AO") can only be added next to Starter units or other Add-On units.
- End-units ("-EU") represent the final seating model in a configuration.
- Arcadia will pre-assemble units at the factory to maximize shipping allowances and minimize field assembly.

WEIGHT CAPACITY:

- Lounge Chairs 400 lbs.
- Tandem Lounge Chairs 350 lbs. per seat
- Love Seats 700 lbs.
- Sofas 900 lbs.

HAVEN LOUNGE

designed by david dahl



SIN #711-16



ARM CAP:

- Radiused edges for smooth surface contact.
- Finger-grip design for added stability.
- Generously proportioned to provide greater support.
- Field-replaceable arm caps featured on all open arm models only.



FLEX BACK:

- Featured on all lounge and tandem lounge models (love seats and sofas not applicable)
- Passive flex back motion provides long-term seated comfort.



CLEAN-OUT PORTAL:

- Featured on all models including love seat and sofa.
- Clean-out area between seat and back enables crumbs and debris to fall through for maintenance ease.



METAL SEAT FRAME:

- Metal seat frame construction ensures durability and allows in-field component replacement as well as add-on capability for tandem units.



OPTIONAL REPLACEABLE UPHOLSTERY:

- Replaceable seat cover available on all models.
- Replaceable back cover available on all lounge and tandem lounge models (love seats and sofas not applicable).

ADDITIONAL STANDARD FEATURES:

- Radiused edges.
- Wall-saver leg design.
- For complete list of replaceable components, please refer to pages 14-15.

NOTES:

- Available in Beech hardwood or metal frame.
- Beech wood, field-replaceable arm caps.
- For Corian arm caps, please specify “-CO” in place of the “-W” after model number (with color selection) and refer to options below for upcharge.
- For upholstered inset panel arm, add “-PA” to model number and refer to yardage requirements and pricing listed below.
- Refer to page 13 for two-tone upholstery examples and yardage requirements.

SPECIFY:

1. Model number
2. Frame finish
3. Arm cap finish
4. Upholstery selection
5. Options, as applicable

ORDERING EXAMPLE:

#M4961-CO-MB02

Lounge Chair, Metal Frame
Corian Arm Caps
Moisture Barrier

HAVEN LOUNGE

designed by david dahl

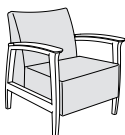
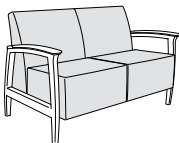
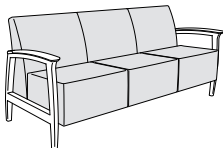

SIN #711-16

MODEL NUMBER	PRODUCT SPECIFICATIONS	FABRIC GRADES										LEATHER GRADES					
		COM	1	2	COL			4	5	6	7	8	L1	L2	L3		
4961-W M4961-W (METAL FRAME) 	Lounge Chair, Open Arm Wood Arm Caps W 28 D 30 ¹ / ₂ H 34 ¹ / ₂ Seat Height 18 Inside Seat Width 23 Inside Seat Depth 18 ¹ / ₂ Arm Height 25 ³ / ₄ 3 Yds. 59 lbs. COL 60 Sq. Ft. TB 133, add \$144 List	Wood Frame	1752	1923	1964	2036	2108	2178	2250	2316	2389	2720	2962	3198			
		Metal Frame	1700	1871	1912	1984	2056	2126	2198	2264	2337	2668	2910	3146			
4962-W M4962-W (METAL FRAME) 	Love Seat, Open Arm Wood Arm Caps W 51 ¹ / ₄ D 30 ¹ / ₂ H 34 ¹ / ₂ Seat Height 18 Inside Seat Width 46 Inside Seat Depth 18 ¹ / ₂ Arm Height 25 ³ / ₄ 5 Yds. 81 lbs. COL 100 Sq. Ft. TB 133, add \$243 List	Wood Frame	2219	2503	2571	2692	2813	2928	3049	3159	3280	3831	4235	4629			
		Metal Frame	2153	2437	2505	2626	2747	2862	2983	3093	3214	3765	4169	4563			
4963-W M4963-W (METAL FRAME) 	Sofa, Open Arm Wood Arm Caps W 75 ¹ / ₄ D 30 ¹ / ₂ H 34 ¹ / ₂ Seat Height 18 Inside Seat Width 69 Inside Seat Depth 18 ¹ / ₂ Arm Height 25 ³ / ₄ 7 Yds. 119 lbs. COL 140 Sq. Ft. TB 133, add \$336 List	Wood Frame	2804	3201	3297	3466	3635	3797	3966	4120	4289	5061	5627	6178			
		Metal Frame	2722	3119	3215	3384	3553	3715	3884	4038	4207	4979	5545	6096			
-PA	Upholstered Inset Panel Arm (wood or metal frame, per arm) 1 ¹ / ₂ Yd. COL 30 Sq. Ft. TB 133, add \$72 List per arm		168	254	274	310	346	381	417	450	487	652	773	891			

OPTIONS (XXXX - REFERS TO CHAIR MODEL NUMBER)

MODEL	DESCRIPTION	LIST
XXXX-CO	Corian Arm Caps	300
XXXX-SC02	Replaceable Seat Cover (all models, per seat)	60
XXXX-BC02	Replaceable Back Cover (lounge model only, per back)	45
XXXX-MB02	Moisture Barrier, Lounge (seat only, per unit)	95
XXXX-MB03	Moisture Barrier, Love Seat (seat only, per unit)	145
XXXX-MB05	Moisture Barrier, Sofa (seat only, per unit)	215
XXXX-NS02B	Non-Skid Glides (per chair)	20

HAVEN LOUNGE

designed by david dahl



SIN #711-16

NOTES:

- Available in Beech hardwood or metal frame.
- Black urethane, field-replaceable arm caps.
- For upholstered inset panel arm, add “-PA” to model number and refer to yardage requirements and pricing listed below.
- Refer to page 13 for two-tone upholstery examples and yardage requirements.

SPECIFY:

1. Model number
2. Frame finish
3. Upholstery selection
4. Options, as applicable

ORDERING EXAMPLE:

#4962-U-SC02
Love Seat, Wood Frame
Replaceable Seat Cover

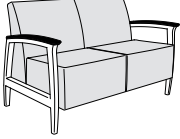
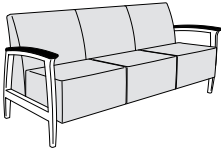
MODEL NUMBER	PRODUCT SPECIFICATIONS	FABRIC GRADES							LEATHER GRADES					
		COM	1	2	COL			8	L1	L2	L3			
4961-U M4961-U (METAL FRAME) 	Lounge Chair, Open Arm Black Urethane Arm Caps W 28 D 30 ¹ / ₂ H 34 ¹ / ₂ Seat Height 18 Inside Seat Width 23 Inside Seat Depth 18 ¹ / ₂ Arm Height 25 ³ / ₄ 3 Yds. 59 lbs. COL 60 Sq. Ft. TB 133, add \$144 List	Wood Frame	1752	1923	1964	2036	2108	2178	2250	2316	2389	2720	2962	3198
		Metal Frame	1700	1871	1912	1984	2056	2126	2198	2264	2337	2668	2910	3146
4962-U M4962-U (METAL FRAME) 	Love Seat, Open Arm Black Urethane Arm Caps W 51 ¹ / ₄ D 30 ¹ / ₂ H 34 ¹ / ₂ Seat Height 18 Inside Seat Width 46 Inside Seat Depth 18 ¹ / ₂ Arm Height 25 ³ / ₄ 5 Yds. 81 lbs. COL 100 Sq. Ft. TB 133, add \$240 List	Wood Frame	2219	2503	2571	2692	2813	2928	3049	3159	3280	3831	4235	4629
		Metal Frame	2153	2437	2505	2626	2747	2862	2983	3093	3214	3765	4169	4563
4963-U M4963-U (METAL FRAME) 	Sofa, Open Arm Black Urethane Arm Caps W 75 ¹ / ₄ D 30 ¹ / ₂ H 34 ¹ / ₂ Seat Height 18 Inside Seat Width 69 Inside Seat Depth 18 ¹ / ₂ Arm Height 25 ³ / ₄ 7 Yds. 119 lbs. COL 140 Sq. Ft. TB 133, add \$336 List	Wood Frame	2804	3201	3297	3466	3635	3797	3966	4120	4289	5061	5627	6178
		Metal Frame	2722	3119	3215	3384	3553	3715	3884	4038	4207	4979	5545	6096
-PA	Upholstered Inset Panel Arm (wood or metal frame, per arm) 1 ¹ / ₂ Yd. COL 30 Sq. Ft. TB 133, add \$72 List per arm		168	254	274	310	346	381	417	450	487	652	773	891

OPTIONS (XXXX - REFERS TO CHAIR MODEL NUMBER)

MODEL	DESCRIPTION	LIST
XXXX-SC02	Replaceable Seat Cover (all models, per seat)	60
XXXX-BC02	Replaceable Back Cover (lounge model only, per back)	45
XXXX-MB02	Moisture Barrier, Lounge (seat only, per unit)	95
XXXX-MB03	Moisture Barrier, Love Seat (seat only, per unit)	145
XXXX-MB05	Moisture Barrier, Sofa (seat only, per unit)	215
XXXX-NS02B	Non-Skid Glides (per chair)	20

NOTES:

- Legs available in Beech hardwood or metal.
- Black urethane arm caps.
- **Note: Panel arm thickness with urethane arm caps is 1" less than with wood or Corian arm caps.**
- Refer to page 13 for two-tone upholstery examples and yardage requirements.

SPECIFY:

1. Model number
2. Leg finish
3. Upholstery selection
4. Options, as applicable

ORDERING EXAMPLE:

#4965-U-MB02
 Lounge Chair, Wood Frame
 Black Urethane Arm Caps
 Moisture Barrier

HAVEN LOUNGE

designed by david dahl

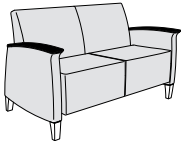
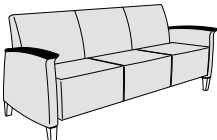

SIN #711-16

MODEL NUMBER	PRODUCT SPECIFICATIONS	FABRIC GRADES							LEATHER GRADES								
		COM	1	2	COL			3	4	5	6	7	8	L1	L2	L3	
4965-U M4965-U (METAL LEGS) 	Lounge Chair, Upholstered Arm Black Urethane Arm Caps W 27 ¹ / ₂ D 30 ¹ / ₂ H 34 ¹ / ₂ Seat Height 18 Inside Seat Width 23 Inside Seat Depth 18 ¹ / ₂ Arm Height 25 ³ / ₄ 7 ¹ / ₂ Yds. 84 lbs. COL 110 Sq. Ft. TB 133, add \$264 List	Wood Legs	1753	2065	2140	2273	2406	2533	2666	2787	2920	3526	3971	4404			
		Metal Legs	1701	2013	2088	2221	2354	2481	2614	2735	2868	3474	3919	4352			
4966-U M4966-U (METAL LEGS) 	Love Seat, Upholstered Arm Black Urethane Arm Caps W 51 ¹ / ₄ D 30 ¹ / ₂ H 34 ¹ / ₂ Seat Height 18 Inside Seat Width 47 Inside Seat Depth 18 ¹ / ₂ Arm Height 25 ³ / ₄ 7 ¹ / ₂ Yds. 118 lbs. COL 150 Sq. Ft. TB 133, add \$360 List	Wood Legs	2251	2677	2779	2960	3141	3315	3496	3661	3842	4669	5275	5866			
		Metal Legs	2184	2610	2712	2893	3074	3248	3429	3594	3775	4602	5208	5799			
4967-U M4967-U (METAL LEGS) 	Sofa, Upholstered Arm Black Urethane Arm Caps W 74 ³ / ₄ D 30 ¹ / ₂ H 34 ¹ / ₂ Seat Height 18 Inside Seat Width 70 ¹ / ₂ Inside Seat Depth 18 ¹ / ₂ Arm Height 25 ³ / ₄ 9 ¹ / ₂ Yds. 150 lbs. COL 190 Sq. Ft. TB 133, add \$456 List	Wood Legs	3195	3734	3864	4093	4323	4542	4772	4981	5210	6258	7026	7774			
		Metal Legs	3101	3640	3770	3999	4229	4448	4678	4887	5116	6164	6932	7680			

OPTIONS (XXXX - REFERS TO CHAIR MODEL NUMBER)

MODEL	DESCRIPTION	LIST
XXXX-SC02	Replaceable Seat Cover (all models, per seat)	60
XXXX-BC02	Replaceable Back Cover (lounge model only, per back)	45
XXXX-MB02	Moisture Barrier, Lounge (seat only, per unit)	95
XXXX-MB03	Moisture Barrier, Love Seat (seat only, per unit)	145
XXXX-MB05	Moisture Barrier, Sofa (seat only, per unit)	215
XXXX-NS02B	Non-Skid Glides (per chair)	20
XXXX-C01	Casters (lounge model only)	50
XXXX-P01	Pull (lounge model only, when specified with casters)	50

HAVEN LOUNGE

designed by david dahl



SIN #711-16

NOTES:

- Legs available in Beech hardwood or metal.
- Beech wood, field-replaceable arm caps.
- For Corian arm caps, please specify “-CO” in place of the “-W” after model number (with color selection) and refer to options below for upcharge.
- Refer to page 13 for two-tone upholstery examples and yardage requirements.

SPECIFY:

1. Model number
2. Arm cap finish
3. Leg finish
4. Upholstery selection
5. Options, as applicable

ORDERING EXAMPLE:

#4971-W-SC02-MB02
 Lounge Chair, Wood Frame
 Replaceable Seat Cover
 Moisture Barrier

MODEL NUMBER	PRODUCT SPECIFICATIONS	FABRIC GRADES							LEATHER GRADES				
		COM	1	2	COL 3	4	5	6	7	8	L1	L2	L3
4971-W M4971-W (METAL LEGS)	Lounge Chair, Upholstered Arm Wood Arm Caps W 29 ¹ / ₂ D 30 ¹ / ₂ H 34 ¹ / ₂ Seat Height 18 Inside Seat Width 23 Inside Seat Depth 18 ¹ / ₂ Arm Height 25 ³ / ₄ 5 ¹ / ₂ Yds. 84 lbs. COL 110 Sq. Ft. TB 133, add \$264 List	Wood Legs 1753	2065	2140	2273	2406	2533	2666	2787	2920	3526	3971	4404
		Metal Legs 1701	2013	2088	2221	2354	2481	2614	2735	2868	3474	3919	4352
4972-W M4972-W (METAL LEGS)	Love Seat, Upholstered Arm Wood Arm Caps W 53 ³ / ₄ D 30 ¹ / ₂ H 34 ¹ / ₂ Seat Height 18 Inside Seat Width 47 Inside Seat Depth 18 ¹ / ₂ Arm Height 25 ³ / ₄ 7 ¹ / ₂ Yds. 118 lbs. COL 150 Sq. Ft. TB 133, add \$360 List	Wood Legs 2251	2677	2779	2960	3141	3315	3496	3661	3842	4669	5275	5866
		Metal Legs 2184	2610	2712	2893	3074	3248	3429	3594	3775	4602	5208	5799
4973-W M4973-W (METAL LEGS)	Sofa, Upholstered Arm Wood Arm Caps W 76 ³ / ₄ D 30 ¹ / ₂ H 34 ¹ / ₂ Seat Height 18 Inside Seat Width 70 ¹ / ₂ Inside Seat Depth 18 ¹ / ₂ Arm Height 25 ³ / ₄ 9 ¹ / ₂ Yds. 150 lbs. COL 190 Sq. Ft. TB 133, add \$456 List	Wood Legs 3195	3734	3864	4093	4323	4542	4772	4981	5210	6258	7026	7774
		Metal Legs 3101	3640	3770	3999	4229	4448	4678	4887	5116	6164	6932	7680

OPTIONS (XXXX - REFERS TO CHAIR MODEL NUMBER)

MODEL	DESCRIPTION	LIST
XXXX-CO	Corian Arm Caps	300
XXXX-SC02	Replaceable Seat Cover (all models, per seat)	60
XXXX-BC02	Replaceable Back Cover (lounge model only, per back)	45
XXXX-MB02	Moisture Barrier, Lounge (seat only, per unit)	95
XXXX-MB03	Moisture Barrier, Love Seat (seat only, per unit)	145
XXXX-MB05	Moisture Barrier, Sofa (seat only, per unit)	215
XXXX-NS02B	Non-Skid Glides (per chair)	20
XXXX-CHR02	Cup Holder (polished aluminum)	210
XXXX-C01	Casters (lounge model only)	50
XXXX-P01	Pull (lounge model only, when specified with casters)	50
XXXX-TAR08	Veneer/Laminate Rotating Tablet, Right (as seated)	372
XXXX-TAL08	Veneer/Laminate Rotating Tablet, Left (as seated)	372
XXXX-TAR08-CO	Corian Rotating Tablet, Right (as seated)	674
XXXX-TAL08-CO	Corian Rotating Tablet, Left (as seated)	674
XXXX-PB1-S, XXXX-PB1-W	Power Band 1 (one power, two USB), Silver or White	413
XXXX-PB2-S, XXXX-PB2-W	Power Band 2 (dual power), Silver or White	322
XXXX-PB3-S, XXXX-PB3-W	Power Band 3 (dual power, two USB), Silver or White	429

NOTES:

- Legs available in Beech hardwood or metal.
- Refer to page 13 for two-tone upholstery examples and yardage requirements.

SPECIFY:

- Model number
- Leg finish
- Upholstery selection
- Options, as applicable

ORDERING EXAMPLE:

#4976-TAR08-C01

Lounge Chair, Wood Legs
Veneer Rotating Tablet, Right
Casters

HAVEN LOUNGE

designed by david dahl

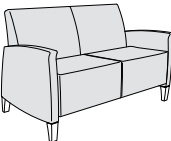
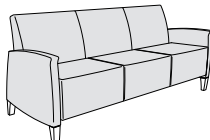

SIN #711-16

MODEL NUMBER	PRODUCT SPECIFICATIONS		FABRIC GRADES								LEATHER GRADES			
			COM	1	2	COL			4	5	6	7	8	L1
4975 M4975 (METAL LEGS) 	Lounge Chair, Fully Upholstered W 28 ¹ / ₂ D 30 ¹ / ₂ H 34 ¹ / ₂ Seat Height 18 Inside Seat Width 23 Inside Seat Depth 18 ¹ / ₂ Arm Height 25 ³ / ₄ 5 ³ / ₄ Yds. 84 lbs. COL 115 Sq. Ft. TB 133, add \$265 List	Wood Legs	1613	1940	2018	2157	2296	2429	2567	2694	2833	3467	3932	4385
		Metal Legs	1566	1893	1971	2110	2249	2382	2520	2647	2786	3420	3885	4338
4976 M4976 (METAL LEGS) 	Love Seat, Fully Upholstered W 52 ¹ / ₄ D 30 ¹ / ₂ H 34 ¹ / ₂ Seat Height 18 Inside Seat Width 47 Inside Seat Depth 18 ¹ / ₂ Arm Height 25 ³ / ₄ 7 ³ / ₄ Yds. 118 lbs. COL 155 Sq. Ft. TB 133, add \$357 List	Wood Legs	2111	2551	2657	2844	3031	3210	3397	3568	3755	4610	5236	5847
		Metal Legs	2048	2488	2594	2781	2968	3147	3334	3505	3692	4547	5173	5784
4977 M4977 (METAL LEGS) 	Sofa, Fully Upholstered W 75 ³ / ₄ D 30 ¹ / ₂ H 34 ¹ / ₂ Seat Height 18 Inside Seat Width 70 ¹ / ₂ Inside Seat Depth 18 ¹ / ₂ Arm Height 25 ³ / ₄ 9 ³ / ₄ Yds. 150 lbs. COL 195 Sq. Ft. TB 133, add \$449 List	Wood Legs	2740	3293	3426	3662	3897	4123	4358	4573	4808	5883	6672	7440
		Metal Legs	2659	3212	3345	3581	3816	4042	4277	4492	4727	5802	6591	7359

OPTIONS (XXXX - REFERS TO CHAIR MODEL NUMBER)

MODEL	DESCRIPTION	LIST
XXXX-SC02	Replaceable Seat Cover (all models, per seat)	60
XXXX-BC02	Replaceable Back Cover (lounge model only, per back)	45
XXXX-MB02	Moisture Barrier, Lounge (seat only, per unit)	95
XXXX-MB03	Moisture Barrier, Love Seat (seat only, per unit)	145
XXXX-MB05	Moisture Barrier, Sofa (seat only, per unit)	215
XXXX-NS02B	Non-Skid Glides (per chair)	20
XXXX-C01	Casters (lounge model only)	50
XXXX-CHR02	Cup Holder (polished aluminum)	210
XXXX-P01	Pull (lounge model only, when specified with casters)	50
XXXX-TAR08	Veneer/Laminate Rotating Tablet, Right (as seated)	372
XXXX-TAL08	Veneer/Laminate Rotating Tablet, Left (as seated)	372
XXXX-TAR08-CO	Corian Rotating Tablet, Right (as seated)	674
XXXX-TAL08-CO	Corian Rotating Tablet, Left (as seated)	674
XXXX-PB1-S, XXXX-PB1-W	Power Band 1 (one power, two USB), Silver or White	413
XXXX-PB2-S, XXXX-PB2-W	Power Band 2 (dual power), Silver or White	322
XXXX-PB3-S, XXXX-PB3-W	Power Band 3 (dual power, two USB), Silver or White	429

HAVEN LOUNGE

designed by david dahl



NOTES:

- Reconfigurable modular units.
- Specify models from left to right of required configuration (as facing), refer to page 3 for additional information.
- Available in Beech hardwood or metal frame.
- For Corian arm caps, please specify “-CO” in place of the “-W” after model number (with color selection) and refer to options below for upcharge.
- For upholstered inset panel arm, add “-PA” to model number and refer to yardage requirements and pricing listed below.
- Refer to page 13 for two-tone upholstery examples and yardage requirements.

SPECIFY:

1. Model number
2. Arm cap finish
3. Frame finish
4. Upholstery selection
5. Options, as applicable

Arcadia will pre-assemble units at the factory to maximize shipping allowances and minimize field assembly.

ORDERING EXAMPLE:

#4980-AO-CO-SC02

Tandem Lounge Add-On, Wood Frame
Corian Arm Caps
Replaceable Seat Cover

SIN #711-16

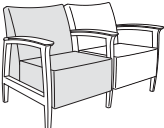
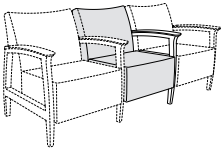
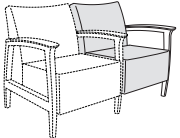
MODEL NUMBER	PRODUCT SPECIFICATIONS	FABRIC GRADES							LEATHER GRADES					
		COM	1	2	COL 3	4	5	6	7	8	L1	L2	L3	
4980-ST-W M4980-ST-W (METAL FRAME) 	Tandem Lounge Starter Unit Wood Arm Caps W 27 D 30 ¹ / ₂ H 34 ¹ / ₂ Seat Height 18 Inside Seat Width 23 Inside Seat Depth 18 ¹ / ₂ Arm Height 25 ³ / ₄ 3 Yds. 59 lbs. COL 60 Sq. Ft. TB 133, add \$144 List	Wood Frame	1767	1938	1979	2051	2123	2193	2265	2331	2404	2735	2977	3213
		Metal Frame	1714	1885	1926	1998	2070	2140	2212	2278	2351	2682	2924	3160
4980-AO-W M4980-AO-W (METAL FRAME) 	Tandem Lounge Add-On Unit Wood Arm Cap W 25 D 30 ¹ / ₂ H 34 ¹ / ₂ Seat Height 18 Inside Seat Width 23 Inside Seat Depth 18 ¹ / ₂ Arm Height 25 ³ / ₄ 3 Yds. 59 lbs. COL 60 Sq. Ft. TB 133, add \$144 List	Wood Frame	1490	1661	1702	1774	1846	1916	1988	2054	2127	2458	2700	2936
		Metal Frame	1446	1617	1658	1730	1802	1872	1944	2010	2083	2414	2656	2892
4980-EU-W M4980-EU-W (METAL FRAME) 	Tandem Lounge End Unit Wood Arm Cap W 26 D 30 ¹ / ₂ H 34 ¹ / ₂ Seat Height 18 Inside Seat Width 23 Inside Seat Depth 18 ¹ / ₂ Arm Height 25 ³ / ₄ 3 Yds. 59 lbs. COL 60 Sq. Ft. TB 133, add \$144 List	Wood Frame	1490	1661	1702	1774	1846	1916	1988	2054	2127	2458	2700	2936
		Metal Frame	1446	1617	1658	1730	1802	1872	1944	2010	2083	2414	2656	2892
-PA	Upholstered Inset Panel Arm (wood or metal frame, per arm) 1 ¹ / ₂ Yd. COL 30 Sq. Ft. TB 133, add \$69 List per arm		168	254	274	310	346	381	417	450	487	652	773	891

OPTIONS (XXXX - REFERS TO CHAIR MODEL NUMBER)

MODEL	DESCRIPTION	LIST
XXXX-CO	Corian Arm Cap, Wood Frame	150
XXXX-SC02	Replaceable Seat Cover (all models, per seat)	60
XXXX-BC02	Replaceable Back Cover (all models, per back)	45
XXXX-MB02	Moisture Barrier, Lounge (seat only, per unit)	95
XXXX-NS02A	Non-Skid Glides (per arm frame)	10

NOTES:

- Reconfigurable modular units.
- Specify models from left to right of required configuration (as facing), refer to page 3 for additional information.
- Available in Beech hardwood or metal frame.
- Black urethane arm caps.
- For upholstered inset panel arm, add “-PA” to model number and refer to yardage requirements and pricing listed below.
- Refer to page 13 for two-tone upholstery examples and yardage requirements.

SPECIFY:

1. Model number
2. Frame finish
3. Upholstery selection
4. Options, as applicable

Arcadia will pre-assemble units at the factory to maximize shipping allowances and minimize field assembly.

ORDERING EXAMPLE:

#M4980-EU-NS02A

Tandem Lounge End Unit,
Wood Frame
Non-Skid Glides

**HAVEN
LOUNGE**

designed by david dahl

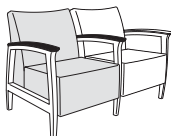
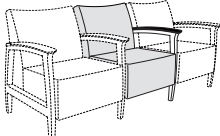
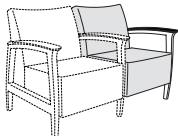

SIN #711-16

MODEL NUMBER	PRODUCT SPECIFICATIONS	FABRIC GRADES							LEATHER GRADES					
		COM	1	2	COL 3	4	5	6	7	8	L1	L2	L3	
4980-ST-U M4980-ST-U (METAL FRAME) 	Tandem Lounge Starter Unit Black Urethane Arm Caps W 27 D 30 ¹ / ₂ H 34 ¹ / ₂ Seat Height 18 Inside Seat Width 23 Inside Seat Depth 18 ¹ / ₂ Arm Height 25 ³ / ₄ 3 Yds. 59 lbs. COL 60 Sq. Ft. TB 133, add \$144 List	Wood Frame	1767	1938	1979	2051	2123	2193	2265	2331	2404	2735	2977	3213
		Metal Frame	1714	1885	1926	1998	2070	2140	2212	2278	2351	2682	2924	3160
4980-AO-U M4980-AO-U (METAL FRAME) 	Tandem Lounge Add-On Unit Black Urethane Arm Cap W 25 D 30 ¹ / ₂ H 34 ¹ / ₂ Seat Height 18 Inside Seat Width 23 Inside Seat Depth 18 ¹ / ₂ Arm Height 25 ³ / ₄ 3 Yds. 59 lbs. COL 60 Sq. Ft. TB 133, add \$144 List	Wood Frame	1490	1661	1702	1774	1846	1916	1988	2054	2127	2458	2700	2936
		Metal Frame	1446	1617	1658	1730	1802	1872	1944	2010	2083	2414	2656	2892
4980-EU-U M4980-EU-U (METAL FRAME) 	Tandem Lounge End Unit Black Urethane Arm Cap W 26 D 30 ¹ / ₂ H 34 ¹ / ₂ Seat Height 18 Inside Seat Width 23 Inside Seat Depth 18 ¹ / ₂ Arm Height 25 ³ / ₄ 3 Yds. 59 lbs. COL 60 Sq. Ft. TB 133, add \$144 List	Wood Frame	1490	1661	1702	1774	1846	1916	1988	2054	2127	2458	2700	2936
		Metal Frame	1446	1617	1658	1730	1802	1872	1944	2010	2083	2414	2656	2892
-PA	Upholstered Inset Panel Arm (wood or metal frame, per arm) 1 ¹ / ₂ Yd. COL 30 Sq. Ft. TB 133, add \$69 List per arm		168	254	274	310	346	381	417	450	487	652	773	891

OPTIONS (XXXX - REFERS TO CHAIR MODEL NUMBER)

MODEL	DESCRIPTION	LIST
XXXX-SC02	Replaceable Seat Cover (all models, per seat)	60
XXXX-BC02	Replaceable Back Cover (all models, per back)	45
XXXX-MB02	Moisture Barrier, Lounge (seat only, per unit)	95
XXXX-NS02A	Non-Skid Glides (per arm frame)	10

HAVEN LOUNGE

designed by david dahl



NOTES:

- Reconfigurable modular units.
- Specify models from left to right of required configuration (as facing), refer to page 3 for additional information.
- Available in Beech hardwood or metal legs.
- For Corian arm caps, please specify “-CO” in place of the “-W” after model number (with color selection) and refer to options below for upcharge.
- Tablets can be affixed to all units.
- Power units can only be affixed to Starter and End units.
- Refer to page 13 for two-tone upholstery examples and yardage requirements.

SPECIFY:

1. Model number
2. Arm cap finish
3. Leg finish
4. Upholstery selection
5. Options, as applicable

Arcadia will pre-assemble units at the factory to maximize shipping allowances and minimize field assembly.

ORDERING EXAMPLE:

#4981-ST-W-SC02

Tandem Lounge Starter, Wood Legs
Wood Arm Caps
Replaceable Seat Cover

SIN #711-16

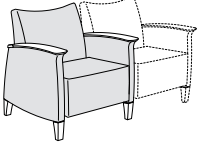
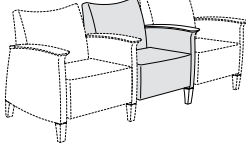
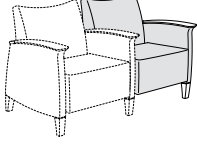
MODEL NUMBER	PRODUCT SPECIFICATIONS	FABRIC GRADES							LEATHER GRADES					
		COM	1	2	COL 3	4	5	6	7	8	L1	L2	L3	
4981-ST-W M4981-ST-W (METAL LEGS) 	Tandem Lounge Starter Unit Upholstered Arm Wood Arm Caps W 27 D 30 ¹ / ₂ H 34 ¹ / ₂ Seat Height 18 Inside Seat Width 23 Inside Seat Depth 18 ¹ / ₂ Arm Height 25 ³ / ₄ 5 ¹ / ₂ Yds. 59 lbs. COL 110 Sq. Ft. TB 133, add \$264 List	Wood Legs	1730	2042	2117	2250	2383	2510	2643	2764	2897	3503	3948	4381
		Metal Legs	1678	1990	2065	2198	2331	2458	2591	2712	2845	3451	3896	4329
4981-AO-W M4981-AO-W (METAL LEGS) 	Tandem Lounge Add-On Unit Upholstered Arm Wood Arm Cap W 25 D 30 ¹ / ₂ H 34 ¹ / ₂ Seat Height 18 Inside Seat Width 23 Inside Seat Depth 18 ¹ / ₂ Arm Height 25 ³ / ₄ 4 ¹ / ₂ Yds. 59 lbs. COL 90 Sq. Ft. TB 133, add \$216 List	Wood Legs	1607	1863	1924	2033	2141	2245	2354	2453	2562	3058	3422	3776
		Metal Legs	1561	1817	1878	1987	2095	2199	2308	2407	2516	3012	3376	3730
4981-EU-W M4981-EU-W (METAL LEGS) 	Tandem Lounge End Unit Upholstered Arm Wood Arm Cap W 26 D 30 ¹ / ₂ H 34 ¹ / ₂ Seat Height 18 Inside Seat Width 23 Inside Seat Depth 18 ¹ / ₂ Arm Height 25 ³ / ₄ 4 ¹ / ₂ Yds. 59 lbs. COL 90 Sq. Ft. TB 133, add \$216 List	Wood Legs	1607	1863	1924	2033	2141	2245	2354	2453	2562	3058	3422	3776
		Metal Legs	1561	1817	1878	1987	2095	2199	2308	2407	2516	3012	3376	3730

OPTIONS (XXXX - REFERS TO CHAIR MODEL NUMBER)

MODEL	DESCRIPTION	LIST
XXXX-SC02	Replaceable Seat Cover (all models, per seat)	60
XXXX-BC02	Replaceable Back Cover (lounge model only, per back)	45
XXXX-MB02	Moisture Barrier, Lounge (seat only, per unit)	95
XXXX-NS02A	Non-Skid Glides (per arm frame)	20
XXXX-CH02	Cup Holder (polished aluminum)	210
XXXX-TAR08	Veneer/Laminate Rotating Tablet, Right (as seated)	372
XXXX-TAL08	Veneer/Laminate Rotating Tablet, Left (as seated)	372
XXXX-TAR08-CO	Corian Rotating Tablet, Right (as seated)	674
XXXX-TAL08-CO	Corian Rotating Tablet, Left (as seated)	674
XXXX-PB1-S, XXXX-PB1-W	Power Band 1 (one power, two USB), Silver or White	413
XXXX-PB2-S, XXXX-PB2-W	Power Band 2 (dual power), Silver or White	322
XXXX-PB3-S, XXXX-PB3-W	Power Band 3 (dual power, two USB), Silver or White	429

NOTES:

- Reconfigurable modular units.
- Specify models from left to right of required configuration (as facing), refer to page 3 for additional information.
- Available in Beech hardwood or metal frame.
- Refer to page 13 for two-tone upholstery examples and yardage requirements.

SPECIFY:

1. Model number
2. Leg finish
3. Upholstery selection
4. Options, as applicable

Arcadia will pre-assemble units at the factory to maximize shipping allowances and minimize field assembly.

ORDERING EXAMPLE:

#M4985-AO-TAR08-CO-NS02A
 Tandem Lounge Add-On, Metal Leg
 Corian Rotating Tablet, Right Non-Skid Glides

HAVEN LOUNGE

designed by david dahl

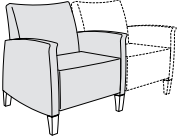
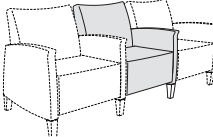
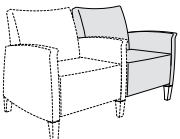

SIN #711-16

MODEL NUMBER	PRODUCT SPECIFICATIONS	FABRIC GRADES										LEATHER GRADES					
		COM	1	2	COL			4	5	6	7	8	L1	L2	L3		
4985-ST M4985-ST (METAL LEGS) 	Tandem Lounge Starter Unit Fully Upholstered Arms W 27 D 30 ¹ / ₂ H 34 ¹ / ₂ Seat Height 18 Inside Seat Width 23 Inside Seat Depth 18 ¹ / ₂ Arm Height 25 ³ / ₄ 5 ³ / ₄ Yds. 59 lbs. COL 115 Sq. Ft. TB 133, add \$276 List	Wood Legs	1613	1940	2018	2157	2296	2429	2567	2694	2833	3467	3932	4385			
		Metal Legs	1566	1893	1971	2110	2249	2382	2520	2647	2786	3420	3885	4338			
4985-AO M4985-AO (METAL LEGS) 	Tandem Lounge Add-On Unit Fully Upholstered Arm W 25 D 30 ¹ / ₂ H 34 ¹ / ₂ Seat Height 18 Inside Seat Width 23 Inside Seat Depth 18 ¹ / ₂ Arm Height 25 ³ / ₄ 4 ¹ / ₂ Yds. 59 lbs. COL 90 Sq. Ft. TB 133, add \$216 List	Wood Legs	1541	1797	1858	1967	2075	2179	2288	2387	2496	2992	3356	3710			
		Metal Legs	1495	1751	1812	1921	2029	2133	2242	2341	2450	2946	3310	3664			
4985-EU M4985-EU (METAL LEGS) 	Tandem Lounge End Unit Fully Upholstered Arm W 26 D 30 ¹ / ₂ H 34 ¹ / ₂ Seat Height 18 Inside Seat Width 23 Inside Seat Depth 18 ¹ / ₂ Arm Height 25 ³ / ₄ 4 ¹ / ₂ Yds. 59 lbs. COL 90 Sq. Ft. TB 133, add \$216 List	Wood Legs	1541	1797	1858	1967	2075	2179	2288	2387	2496	2992	3356	3710			
		Metal Legs	1495	1751	1812	1921	2029	2133	2242	2341	2450	2946	3310	3664			

OPTIONS (XXXX - REFERS TO CHAIR MODEL NUMBER)

MODEL	DESCRIPTION	LIST
XXXX-SC02	Replaceable Seat Cover (all models, per seat)	60
XXXX-BC02	Replaceable Back Cover (lounge model only, per back)	45
XXXX-MB02	Moisture Barrier, Lounge (seat only, per unit)	95
XXXX-NS02A	Non-Skid Glides (per arm frame)	10
XXXX-CHR02	Cup Holder (polished aluminum)	210
XXXX-TAR08	Veneer/Laminate Rotating Tablet, Right (as seated)	372
XXXX-TAL08	Veneer/Laminate Rotating Tablet, Left (as seated)	372
XXXX-TAR08-CO	Corian Rotating Tablet, Right (as seated)	674
XXXX-TAL08-CO	Corian Rotating Tablet, Left (as seated)	674
XXXX-PB1-S, XXXX-PB1-W	Power Band 1 (one power, two USB), Silver or White	413
XXXX-PB2-S, XXXX-PB2-W	Power Band 2 (dual power), Silver or White	322
XXXX-PB3-S, XXXX-PB3-W	Power Band 3 (dual power, two USB), Silver or White	429

HAVEN LOUNGE

designed by david dahl



NOTES:

- Concealed velcro attachment.
- Replacement seat and back covers can be easily field installed on previously ordered Haven models with replaceable cover option.
- Haven models originally ordered with standard fixed upholstery can utilize replacement seat and/or back covers, however some upholstery work will be required to remove original upholstery covers.



SPECIFY:

1. Model number
2. Upholstery selection

ORDERING EXAMPLE:

#RSC-4961
Lounge Replacement Seat Cover

SIN #711-16

MODEL NUMBER	PRODUCT SPECIFICATIONS	FABRIC GRADES							LEATHER GRADES				
		COM	1	2	COL			8	L1	L2	L3		
RSC-4961 	Lounge Replacement Upholstered Seat Cover 1 ¹ / ₄ Yds. COL 25 Sq. Ft. TB 133, add \$60 List Applies to: 4961/M4961 Lounge 4965/M4965 Lounge 4971/M4971 Lounge 4975/M4975 Lounge 4980/M4980 Tandem 4981/M4981 Tandem 4985/M4981 Tandem	173	244	261	292	322	351	381	408	439	576	677	776
RBC-4961 	Lounge Replacement Upholstered Back Cover 1 ³ / ₄ Yds. COL 35 Sq. Ft. TB 133, add \$84 List Applies to: 4961/M4961 Lounge 4965/M4965 Lounge 4971/M4971 Lounge 4975/M4975 Lounge 4980/M4980 Tandem 4981/M4981 Tandem 4985/M4981 Tandem	173	273	297	339	381	422	464	502	545	738	879	1,017

NOTES:

- Replacement hardware included with replacement arms and/or arm caps.

SPECIFY:

1. Model number
2. Wood, metal or Corian finish, as applicable

ORDERING EXAMPLE:









#M4961-05R
Metal Frame Replacement

**HAVEN
LOUNGE**

designed by david dahl



SIN #711-16

MODEL NUMBER	PRODUCT SPECIFICATIONS	LIST
<p>4961-05R (WOOD RIGHT ARM, AS SEATED) 4961-05C (WOOD CENTER ARM, AS SEATED) 4961-05L (WOOD LEFT ARM, AS SEATED)</p> 	<p>Open Arm Models - Replacement Wood Frame No Arm Cap 11 lbs.</p>	<p>246</p>
<p>M4961-05R (METAL RIGHT ARM, AS SEATED) M4961-05C (METAL CENTER ARM, AS SEATED) M4961-05L (METAL LEFT ARM, AS SEATED)</p> 	<p>Open Arm Models - Replacement Metal Frame No Arm Cap 11 lbs.</p>	<p>239</p>
<p>4961-07W (WOOD)</p> 	<p>Open Arm Models - Replacement Wood Arm Cap 2 lbs.</p>	<p>81</p>
<p>4961-07U (URETHANE)</p> 	<p>Open Arm Models - Replacement Black Urethane Arm Cap 2 lbs.</p>	<p>81</p>
<p>4961-07C (CORIAN)</p> 	<p>Open Arm Models - Corian Replacement Arm Cap (standard colors only) 2 lbs.</p>	<p>185</p>
<p>4965-07U (URETHANE)</p> 	<p>Upholstered Arm Models - Replacement Black Urethane Arm Cap (specific to models on page 7) 2 lbs.</p>	<p>81</p>
<p>4971-07W (WOOD)</p> 	<p>Upholstered Arm Models - Replacement Wood Arm Cap 2 lbs.</p>	<p>81</p>
<p>4971-07C (CORIAN)</p> 	<p>Upholstered Arm Models - Replacement Corian Arm Cap (standard colors only) 2 lbs.</p>	<p>185</p>

HAVEN LOUNGE

designed by david dahl



UPHOLSTERY COMBINATIONS:

For fabric, vinyl or leather upholstery combinations, refer to the pricing below:

- When combining **two** COM/COV/COL fabrics, or fabrics with the same grade, add the following (per unit):
 - › \$65 List for lounge chairs
 - › \$105 List for love seats
 - › \$130 List for sofas
- When combining **three or more** COM/COV/COL fabrics, or fabrics with the same grade, add the following (per unit):
 - › \$75 List for lounge chairs
 - › \$115 List for love seats
 - › \$140 List for sofas
- When combining different grades of fabric, price will be based on the highest grade specified.
- Two-tone upholstery examples and yardage requirements for the most common combinations are listed below. Additional combinations available, please contact Customer Service for yardage requirements and pricing.
- Note: Yardage amounts are based on fabric which is plain (i.e. non-directional) and a full 54" wide.
- **Appropriate upholstery code must be included on order.**

SIN #711-16



Code HA5
Models 4961-W/M4961-W
 4961-U/M4961-U
 4980-ST/AO/EU
 M4980-ST/AO/EU
COM Requirement
 Seat Cushion Only = 1¹/₄ yds.
 Balance of Chair = 1³/₄ yds.

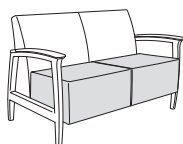

Code HA6
Model 4962-W/M4962-W
 4962-U/M4962-U
COM Requirement
 Seat Cushion Only = 2¹/₂ yds.
 Balance of Love Seat = 3¹/₂ yds.

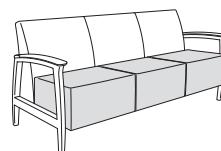

Code HA7
Model 4963-W/M4963-W
 4963-U/M4963-U
COM Requirement
 Seat Cushion Only = 3¹/₂ yds.
 Balance of Sofa = 5 yds.



Code HA8
Model 4965-U/M4965-U
 4971-W/M4971-W
COM Requirement
 Seat Cushion Only = 1¹/₄ yds.
 Balance of Chair = 4³/₄ yds.

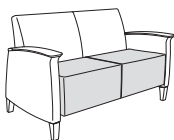

Code HA9
Model 4966-U/M4966-U
 4972-W/M4972-W
COM Requirement
 Seat Cushion Only = 2¹/₂ yds.
 Balance of Love Seat = 5³/₄ yds.

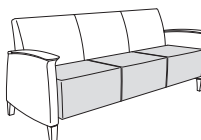

Code HA10
Model 4967-U/M4967-U
 4973-W/M4973-W
COM Requirement
 Seat Cushion Only = 3¹/₂ yds.
 Balance of Sofa = 7 yds.



Code HA11
Model 4965-U/M4965-U
 4971-W/M4971-W
COM Requirement
 Arm Panels = 2³/₄ yds.
 Balance of Chair = 3 yds.

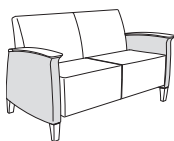

Code HA12
Model 4966-U/M4966-U
 4972-W/M4972-W
COM Requirement
 Arm Panels = 2³/₄ yds.
 Balance of Love Seat = 6 yds.

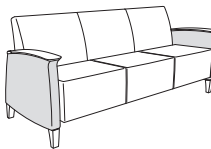

Code HA13
Model 4967-U/M4967-U
 4973-W/M4973-W
COM Requirement
 Arm Panels = 2³/₄ yds.
 Balance of Sofa = 8¹/₂ yds.



Code HA14
Model 4975/M4975
COM Requirement
 Seat Cushion Only = 1¹/₄ yds.
 Balance of Chair = 4 yds.

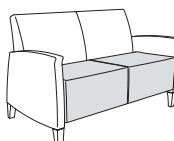

Code HA15
Model 4976/M4976
COM Requirement
 Seat Cushion Only = 2¹/₂ yds.
 Balance of Love Seat = 5³/₄ yds.

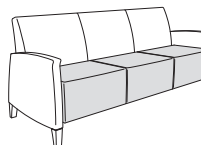

Code HA16
Model 4977/M4977
COM Requirement
 Seat Cushion Only = 3¹/₂ yds.
 Balance of Sofa = 7 yds.

UPHOLSTERY COMBINATIONS:

For fabric, vinyl or leather upholstery combinations, refer to the pricing below:

- When combining **two** COM/COV/COL fabrics, or fabrics with the same grade, add the following (per unit):
 - › \$65 List for lounge chairs
 - › \$105 List for love seats
 - › \$130 List for sofas
- When combining **three or more** COM/COV/COL fabrics, or fabrics with the same grade, add the following (per unit):
 - › \$75 List for lounge chairs
 - › \$115 List for love seats
 - › \$140 List for sofas

- When combining different grades of fabric, price will be based on the highest grade specified.
- Two-tone upholstery examples and yardage requirements for the most common combinations are listed below. Additional combinations available, please contact Customer Service for yardage requirements and pricing.
- Note: Yardage amounts are based on fabric which is plain (i.e. non-directional) and a full 54" wide.
- **Appropriate upholstery code must be included on order.**

HAVEN LOUNGE

designed by david dahl



SIN #711-16



Code HA17
Models 4975/M4975
COM Requirement Arms = 2³/₄ yds.
 Balance of Chair = 3 yds.

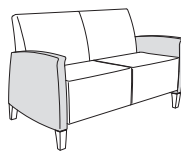

Code HA18
Model 4976/M4976
COM Requirement Arms = 2³/₄ yds.
 Balance of Love Seat = 6 yds.

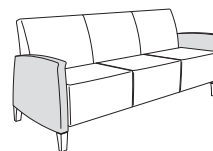

Code HA19
Model 4977/M4977
COM Requirement Arms = 2³/₄ yds.
 Balance of Sofa = 8¹/₂ yds.

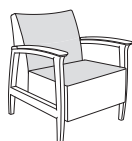

Code HA20
Model 4961-W/M4961-W
 4961-U/M4961-U
 4980-ST/AO/EU
 M4980-ST/AO/EU
COM Requirement Inside Back/Top of Seat = 1 yd.
 Balance of Chair = 2 yds.

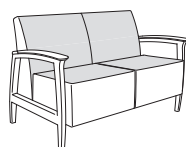

Code HA21
Model 4962-W/M4962-W
 4962-U/M4962-U
COM Requirement Inside Back/Top of Seat = 2 yds.
 Balance of Love Seat = 3¹/₂ yds.

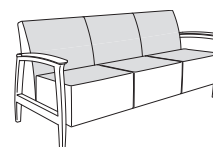

Code HA22
Model 4963-W/M4963-W
 4963-U/M4963-U
COM Requirement Inside Back/Top of Seat = 3 yds.
 Balance of Sofa = 5 yds.

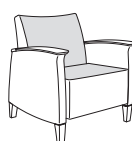

Code HA23
Model 4965-U/M4965-U
 4971-W/M4971-W
COM Requirement Inside Back/Top of Seat = 1 yd.
 Balance of Chair = 4 yds.

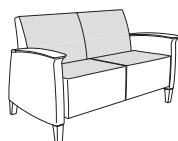

Code HA24
Model 4966-U/M4966-U
 4972-W/M4972-W
COM Requirement Inside Back/Top of Seat = 2 yds.
 Balance of Love Seat = 6¹/₂ yds.

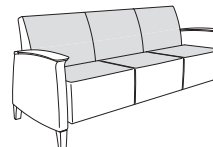

Code HA25
Model 4967-U/M4967-U
 4973-W/M4973-W
COM Requirement Inside Back/Top of Seat = 3 yds.
 Balance of Sofa = 7¹/₂ yds.

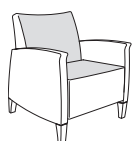

Code HA26
Model 4975/M4975
COM Requirement Inside Back/Top of Seat = 1 yd.
 Balance of Chair = 4 yds.

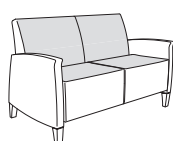

Code HA27
Model 4976/M4976
COM Requirement Inside Back/Top of Seat = 2 yds.
 Balance of Love Seat = 6 yds.

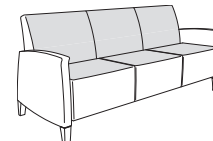

Code HA28
Model 4977/M4977
COM Requirement Inside Back/Top of Seat = 3 yds.
 Balance of Sofa = 8 yds.

HAVEN LOUNGE

designed by david dahl



UPHOLSTERY COMBINATIONS:

For fabric, vinyl or leather upholstery combinations, refer to the pricing below:

- When combining **two** COM/COV/COL fabrics, or fabrics with the same grade, add \$65 List for each starter, add-on and end unit.
- When combining **three or more** COM/COV/COL fabrics, or fabrics with the same grade, add \$75 List for each starter, add-on and end unit.
- When combining different grades of fabric, price will be based on the highest grade specified.
- Two-tone upholstery examples and yardage requirements for the most common combinations are listed below. Additional combinations available, please contact Customer Service for yardage requirements and pricing.
- Note: Yardage amounts are based on fabric which is plain (i.e. non-directional) and a full 54" wide.
- **Appropriate upholstery code must be included on order.**

SIN #711-16

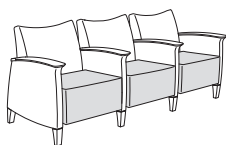

Code **HA29**
Model COM Requirement (per each Starter Unit)
 4981-ST-W Starter Unit Seat Cushion Only = 1¹/₄ yds.
 M4981-ST-W Starter Unit Balance of Chair = 4 yds.

Code **HA30**
Model COM Requirement (per each Add-On or End Unit)
 4981-AO-W Add-On and End Unit Seat Cushion Only = 1¹/₄ yds.
 4981-EU-W Add-On and End Unit Balance of Chair = 3¹/₄ yds.
 M4981-AO-W
 M4981-EU-W

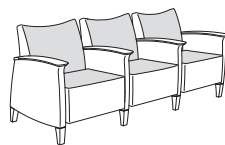

Code **HA31**
Model COM Requirement (per each Starter Unit)
 4981-ST-W Starter Unit Inside Back/Top of Seat = 1 yd.
 M4981-ST-W Starter Unit Balance of Chair = 4 yds.

Code **HA32**
Model COM Requirement (per each Add-On or End Unit)
 4981-AO-W Add-On and End Unit Inside Back/Top of Seat = 1 yd.
 4981-EU-W Add-On and End Unit Balance of Chair = 3 yds.
 M4981-AO-W
 M4981-EU-W

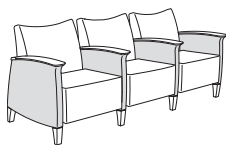

Code **HA33**
Model COM Requirement (per each Starter Unit)
 4981-ST-W Starter Unit Arm Panel = 2³/₄ yds.
 M4981-ST-W Starter Unit Balance of Chair = 3 yds.

Code **HA34**
Model COM Requirement (per each Add-On or End Unit)
 4981-AO-W Add-On or End Unit Arm Panel = 1¹/₂ yds.
 4981-EU-W Add-On or End Unit Balance of Chair = 3 yds.
 M4981-AO-W
 M4981-EU-W

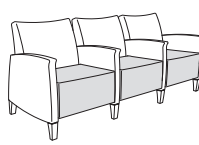

Code **HA35**
Model COM Requirement (per each Starter Unit)
 4985-AO Starter Unit Seat Cushion Only = 1¹/₄ yds.
 M4985-AO Starter Unit Balance of Chair = 4 yds.

Code **HA36**
Model COM Requirement (per each Add-On or End Unit)
 4985-AO Add-On or End Unit Seat Cushion Only = 1¹/₄ yds.
 4985-EU Add-On or End Unit Balance of Chair = 3¹/₄ yds.
 M4981-AO
 M4981-EU

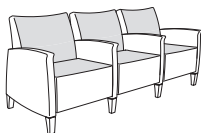

Code **HA37**
Model COM Requirement (per each Starter Unit)
 4985-ST Starter Unit Inside Back/Top of Seat = 1 yd.
 M4985-ST Starter Unit Balance of Chair = 4 yds.

Code **HA38**
Model COM Requirement (per each Add-On or End Unit)
 4985-AO Add-On and End Unit Inside Back/Top of Seat = 1 yd.
 4985-EU Add-On and End Unit Balance of Chair = 3 yds.
 M4985-AO
 M4985-EU

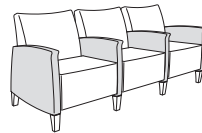

Code **HA39**
Model COM Requirement (per each Starter Unit)
 4985-AO Starter Unit Arms = 2³/₄ yds.
 M4985-AO Starter Unit Balance of Chair = 3 yds.

Code **HA40**
Model COM Requirement (per each Add-On or End Unit)
 4985-AO Add-On and End Unit Arms = 1¹/₂ yds.
 4985-EU Add-On and End Unit Balance of Chair = 3 yds.
 M4985-AO
 M4985-EU

NOTES:

- Tables available with Beech wood or metal legs.
- All tables feature veneer tops as standard. Laminate and Corian tops available.
- For Corian top, specify “-CO” next to model number. Corian top is 1/2" thick in lieu of standard table top thickness of 3/4" .
- All standard and custom wood finishes available on Beech. For custom wood finishes, please add \$400 List per color per order.
- Two-tone wood finishing available at no upcharge.
- Metal legs available in #06 Charcoal Grey and #90 Metallic Silver. For non-standard options, please contact Customer Service.

SPECIFY:

1. Model number
2. Top finish
3. Wood finish
4. Metal leg finish, as applicable

ORDERING EXAMPLE:

#490-2420-CO
24" Round Table, Wood Legs
Corian Top

HAVEN
OCCASIONAL TABLES

designed by david dahl



SIN #711-11

MODEL NUMBER PRODUCT SPECIFICATIONS TABLE TOP FINISH

		MODEL NUMBER	VENEER OR LAMINATE	CORIAN (-CO)	WEIGHT
490 (WOOD SERIES) 	Haven Round Table, Wood 490 Series	490-1818	1183	1553	15
		490-2420	1254	1903	18
		490-3020	1406	2420	27
		490-3620	1714	3391	32
495 (WOOD SERIES) 	Haven Square Table, Wood 495 Series	495-181820	1124	1496	17
		495-242420	1192	1842	20
		495-303020	1349	2361	30
		495-363620	1631	3306	35
		495-482016	1568	2651	42
M490 (METAL SERIES) 	Haven Round Table, Metal M490 Series	M490-1818	1147	1509	20
		M490-2420	1217	1848	23
		M490-3020	1364	2350	32
		M490-3620	1664	3292	37
M495 (METAL SERIES) 	Haven Square Table, Metal M495 Series	M495-181820	1090	1454	22
		M495-242420	1158	1790	25
		M495-303020	1309	2292	35
		M495-363620	1583	3210	40
		M495-482016	1522	2574	47

METAL LEG FINISHES:

- #06 Charcoal Grey
- #85 Metallic Silver

For non-standard options, please contact Customer Service.

CORIAN® TOP COLORS:

- Designer White
- Linen
- Rain Cloud
- Witch Hazel

Please note all dimensions listed above are nominal.

HUDDLE LOUNGE

designed by david dahl



SIN #711-16

PRODUCT FEATURES:

- Lounge chair models available in two back heights: 30¹/₂" and 33¹/₂".
- Fixed seat cushion.
- Two standard metal platform base configurations: fixed wood legs or casters.
- Metal platform available in two standard powdercoat finishes: #90 Metallic Silver and #95 Satin Black.
- Wood legs available in all standard and custom wood finishes on Beech.
- For custom wood finishes (to legs and/or tablets), please add one-time upcharge of \$400 List per color per order.
- Mobile version comes standard with two locking casters in rear and two non-locking casters in front.
- Caster color will match specified metal platform finish, unless specified otherwise.
- Soft-tread casters available, silver color only. Please specify "-C05" and add \$50 List per set (includes 4 casters).
- Non-skid glides available for hard surface floors. Please specify "-NS02B" after model number and add \$20 List per chair.
- Optional pull available on back of mobile lounge chairs only. Please specify "-P01" next to model number and add \$50 List per unit. Satin nickel finish.
- Maximum weight capacity is 350 lbs. for lounge chairs, 700 lbs. for love seats and 1000 lbs. for sofas.
- Please refer to page 6 for two-tone upholstery examples, yardage requirements and pricing.
- All dimensions are nominal.

ROTATING TABLET:

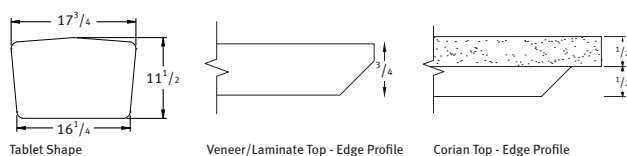

- Tablet affixed to right or left arm, as specified.
- Tablet size is 17³/₄" W x 11¹/₂" D x 3³/₄" thick.
- Rotating tablet features 360-degree turning radius.
- Three tablet surface options: Beech veneer, laminate or Corian.
- All standard and custom wood finishes available on Beech.
- For custom wood finishes, please add \$400 List per color per order.
- For standard laminates, refer to Standard Finish Card.
- For custom laminates, add \$500 List per color per order. Pre-approval required, please contact Customer Service.
- Corian available in four standard colors. For non-standard options, please contact Customer Service for pricing.

CORIAN® COLORS:

Designer White
Linen
Rain Cloud
Witch Hazel

Corian® is a registered trademark of Dupont.

HUDDLE LOUNGE

designed by david dahl

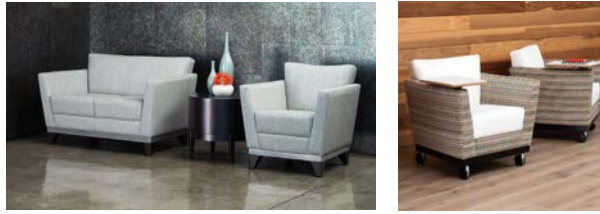

SIN #711-16

TABLET EDGE FINISH SPECIFICATIONS:

- For veneer tops, edge finish will always match the top finish color, unless otherwise specified.
- For standard laminate tops (laminate cannot be applied to the edge):
 - › Wood grain laminates, edge finish will match the laminate top color, unless otherwise specified.
 - › Solid color laminates, edge finish will be natural (clear coat) as standard, unless otherwise specified.
- For Corian tops:
 - › Designer White, Rain Cloud and Linen colors, edge will be white as standard, unless otherwise specified.
 - › Witch Hazel, edge will be natural (clear coat) as standard, unless otherwise specified.
- Edges are also available in all standard wood finishes, please specify. For custom edge finishes, please add one-time upcharge of \$400 List per color, per order.

POWER UNITS:

- Unit affixed to right side, as seated, unless otherwise specified.
- If specified in conjunction with a tablet, power unit will be mounted to same side as tablet, unless otherwise specified.
- PB1 and PB2 dimensions: 5³/₄" W x 2¹/₂" D
- PB3 dimensions: 6¹/₂" W x 2¹/₂" D
- Metallic Silver or White finish with 108" electrical cord.
- UL listed.

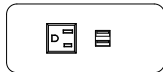

PB1



PB2

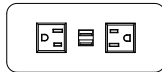

PB3

- PB1 unit features one outlet and two USB charging ports.
- PB2 unit features two outlets.
- PB3 unit features two outlets and two USB charging ports.

NOTES:

- Standard base configuration includes metal platform with fixed Beech wood legs.
- Metal platform available in two standard powdercoat finishes: #90 Metallic Silver and #95 Satin Black.
- Refer to page 6 for two-tone upholstery examples and yardage requirements.

SPECIFY:

- Model number
- Metal platform finish
- Wood leg finish
- Upholstery selection
- Options, as applicable

ORDERING EXAMPLE:

#2201-TAR09-PB1-W

Lounge Chair
Veneer Tablet, Right
Power Band 1 Unit, White

HUDDLE LOUNGE

designed by david dahl

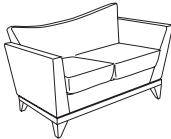
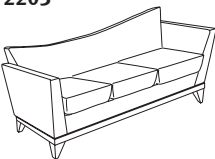

SIN #711-16

MODEL NUMBER	PRODUCT SPECIFICATIONS	FABRIC GRADES								LEATHER GRADES			
		COM	1	2	COL			7	8	L1	L2	L3	
2201	 <p>Lounge Chair W 29 D 29¹/₂ H 30¹/₂ Seat Height 18 Inside Seat Width 19¹/₂ Inside Seat Depth 19 Arm Height 25 4 Yds. 63 lbs. COL 80 Sq. Ft. TB 133, add \$192 List</p>	1542	1769	1824	1920	2017	2109	2206	2294	2391	2832	3155	3470
2202	 <p>Love Seat W 50 D 29¹/₂ H 30¹/₂ Seat Height 18 Inside Seat Width 40¹/₂ Inside Seat Depth 19 Arm Height 25 6 Yds. 93 lbs. COL 120 Sq. Ft. TB 133, add \$288 List</p>	2090	2431	2513	2657	2802	2941	3086	3218	3363	4025	4510	4982
2203	 <p>Sofa W 70 D 29¹/₂ H 30¹/₂ Seat Height 18 Inside Seat Width 60¹/₂ Inside Seat Depth 19 Arm Height 25 8 Yds. 118 lbs. COL 160 Sq. Ft. TB 133, add \$384 List</p>	2756	3210	3319	3512	3706	3890	4084	4260	4453	5335	5982	6612

OPTIONS (XXXX - REFERS TO CHAIR MODEL NUMBER)

MODEL	DESCRIPTION	LIST
XXXX-TAR09	Veneer/Laminate Rotating Tablet, Right (as seated)	326
XXXX-TAL09	Veneer/Laminate Rotating Tablet, Left (as seated)	326
XXXX-TAR09-CO	Corian Rotating Tablet, Right (as seated)	629
XXXX-TAL09-CO	Corian Rotating Tablet, Left (as seated)	629
XXXX-PB1-S	Power Band 1 (one power, two USB), Silver	413
XXXX-PB1-W	Power Band 1 (one power, two USB), White	413
XXXX-PB2-S	Power Band 2 (dual power), Silver	322
XXXX-PB2-W	Power Band 2 (dual power), White	322
XXXX-PB3-S	Power Band 3 (dual power, two USB), Silver	429
XXXX-PB3-W	Power Band 3 (dual power, two USB), White	429
XXXX-NS02B	Non-Skid Glides	20

HUDDLE LOUNGE

designed by david dahl



SIN #711-16

NOTES:

- Lounge chair features 3" higher back.
- Standard base configuration includes metal platform with fixed Beech wood legs.
- Metal platform available in two standard powdercoat finishes: #90 Metallic Silver and #95 Satin Black.
- Refer to page 6 for two-tone upholstery examples and yardage requirements.

SPECIFY:

1. Model number
2. Metal platform finish
3. Wood leg finish
4. Upholstery selection
5. Options, as applicable

ORDERING EXAMPLE:

#2201-H-TAR09-CO-PB1-S

High Back Lounge Chair
Corian Tablet, Right
Power Band 1 Unit, Silver

MODEL NUMBER	PRODUCT SPECIFICATIONS	FABRIC GRADES							LEATHER GRADES							
		COM	1	2	COL			3	4	5	6	7	8	L1	L2	L3
2201-H	 <p>High Back Lounge Chair W 29 D 29¹/₂ H 33¹/₂ Seat Height 18 Inside Seat Width 19¹/₂ Inside Seat Depth 19 Arm Height 25 4¹/₂ Yds. 66 lbs. COL 90 Sq. Ft. TB 133, add \$216 List</p>	1679	1935	1996	2105	2213	2317	2426	2525	2634	3130	3494	3848			

OPTIONS (XXXX - REFERS TO CHAIR MODEL NUMBER)		
MODEL	DESCRIPTION	LIST
XXXX-TAR09	Veneer/Laminate Rotating Tablet, Right (as seated)	326
XXXX-TAL09	Veneer/Laminate Rotating Tablet, Left (as seated)	326
XXXX-TAR09-CO	Corian Rotating Tablet, Right (as seated)	629
XXXX-TAL09-CO	Corian Rotating Tablet, Left (as seated)	629
XXXX-PB1-S	Power Band 1 (one power, two USB), Silver	413
XXXX-PB1-W	Power Band 1 (one power, two USB), White	413
XXXX-PB2-S	Power Band 2 (dual power), Silver	322
XXXX-PB2-W	Power Band 2 (dual power), White	322
XXXX-PB3-S	Power Band 3 (dual power, two USB), Silver	429
XXXX-PB3-W	Power Band 3 (dual power, two USB), White	429
XXXX-NS02B	Non-Skid Glides	20

NOTES:

- Standard base configuration includes metal platform with casters.
- Metal platform available in two standard powdercoat finishes: #90 Metallic Silver and #95 Satin Black.
- Two locking casters in rear and two non-locking casters in front.
- Caster color will match specified metal platform finish, unless specified otherwise.
- Refer to page 6 for two-tone upholstery examples and yardage requirements.

SPECIFY:

1. Model number
2. Metal platform finish
3. Upholstery selection
4. Options, as applicable

ORDERING EXAMPLE:

#2221-TAL09-CO-P01



Lounge Chair
Corian Tablet, Left
Pull Handle

HUDDLE LOUNGE

designed by david dahl



SIN #711-16

MODEL NUMBER	PRODUCT SPECIFICATIONS	FABRIC GRADES							LEATHER GRADES				
		COM	1	2	COL		5	6	7	8	L1	L2	L3
2221 	Lounge Chair, Casters W 29 D 29 ¹ / ₂ H 30 ¹ / ₂ Seat Height 18 Inside Seat Width 19 ¹ / ₂ Inside Seat Depth 19 Arm Height 25 4 Yds. 63 lbs. COL 80 Sq. Ft. TB 133, add \$184 List	1582	1809	1864	1960	2057	2149	2246	2334	2431	2872	3195	3510
2221-H 	High Back Lounge Chair, Casters W 29 D 29 ¹ / ₂ H 33 ¹ / ₂ Seat Height 18 Inside Seat Width 19 ¹ / ₂ Inside Seat Depth 19 Arm Height 25 4 ¹ / ₂ Yds. 66 lbs. COL 90 Sq. Ft. TB 133, add \$207 List	1894	2150	2211	2320	2428	2532	2641	2740	2849	3345	3709	4063

OPTIONS (XXXX - REFERS TO CHAIR MODEL NUMBER)

MODEL	DESCRIPTION	LIST
XXXX-TAR09	Veneer/Laminate Rotating Tablet, Right (as seated)	326
XXXX-TAL09	Veneer/Laminate Rotating Tablet, Left (as seated)	326
XXXX-TAR09-CO	Corian Rotating Tablet, Right (as seated)	629
XXXX-TAL09-CO	Corian Rotating Tablet, Left (as seated)	629
XXXX-P01	Pull Handle	50
XXXX-C05	Soft Tread Casters	50

HUDDLE LOUNGE

designed by david dahl



UPHOLSTERY COMBINATIONS:

For fabric, vinyl or leather upholstery combinations, refer to the pricing below:

- When combining **two** COM/COV/COL fabrics, or fabrics with the same grade, add the following (per unit):
 - › \$65 List for lounge chairs
 - › \$105 List for love seats
 - › \$130 List for sofas
- When combining **three or more** COM/COV/COL fabrics, or fabrics with the same grade, add the following (per unit):
 - › \$75 List for lounge chairs
 - › \$115 List for love seats
 - › \$140 List for sofas

- When combining different grades of fabric, price will be based on the highest grade specified.
- Two-tone upholstery examples and yardage requirements for the most common combinations are listed below. Additional combinations available, please contact Customer Service for yardage requirements and pricing.
- Note: Yardage amounts are based on fabric which is plain (i.e. non-directional) and a full 54" wide.
- **Appropriate upholstery code must be included on order.**

SIN #711-16



Code HU1
Model COM Requirement
 2201 Entire Back = 1³/₄ yds.
 2221 Balance of Chair = 2³/₄ yds.

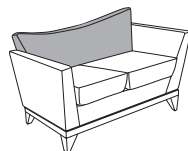

Code HU2
Model COM Requirement
 2202 Entire Back = 2¹/₂ yds.
 Balance of Love Seat = 4 yds.

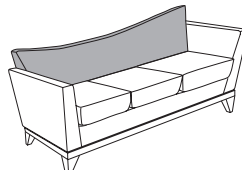

Code HU3
Model COM Requirement
 2203 Entire Back = 3¹/₄ yds.
 Balance of Sofa = 5¹/₄ yds.

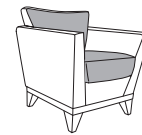

Code HU4
Model COM Requirement
 2201 Inside Back/Seat
 Cushion = 1¹/₂ yds.
 Balance of Chair = 3¹/₂ yds.

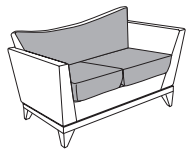

Code HU5
Model COM Requirement
 2202 Inside Back/Seat
 Cushion = 2¹/₂ yds.
 Balance of Love Seat = 4¹/₂ yds.

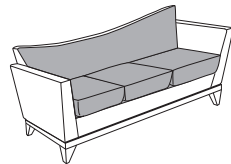

Code HU6
Model COM Requirement
 2203 Inside Back/Seat
 Cushion = 3¹/₂ yds.
 Balance of Sofa = 5¹/₂ yds.



Code HU7
Model COM Requirement
 2201 Seat Cushion Only = 1 yd.
 2221 Balance of Chair = 3¹/₂ yds.

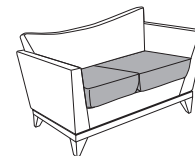

Code HU8
Model COM Requirement
 2202 Seat Cushion Only = 2 yds.
 Balance of Love Seat = 4¹/₂ yds.

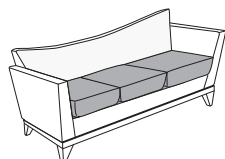

Code HU9
Model COM Requirement
 2203 Seat Cushion Only = 3 yds.
 Balance of Sofa = 5¹/₂ yds.



Code HU10
Model COM Requirement
 2201 Entire Back/Seat
 Cushion = 2¹/₂ yds.
 2221 Balance of Chair = 2¹/₄ yds.



Code HU11
Model COM Requirement
 2202 Entire Back/Seat
 Cushion = 4¹/₄ yds.
 Balance of Love Seat = 2¹/₂ yds.

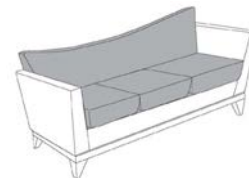

Code HU12
Model COM Requirement
 2203 Entire Back/Seat Cushion = 6 yds.
 Balance of Sofa = 3³/₄ yds.



Code HU13
Model COM Requirement
 2201-H Entire Back = 2 yds.
 2221-H Balance of Chair = 2³/₄ yds.



Code HU14
Model COM Requirement
 2201-H Inside Back/Seat
 Cushion = 1³/₄ yds.
 2221-H Balance of Chair = 3¹/₂ yds.



Code HU15
Model COM Requirement
 2201-H Seat Cushion Only = 1 yd.
 2221-H Balance of Chair = 4 yds.



Code HU16
Model COM Requirement
 2201-H Entire Back/Seat
 Cushion = 2³/₄ yds.
 Balance of Chair = 2¹/₄ yds.



HUSH BENCHES

designed by 5d studio



SIN #711-16

PRODUCT FEATURES:

- Fixed seat cushions.
- Fixed legs available in four finishes: #06 Charcoal Grey, #90 Metallic Silver, #92 Polished Aluminum and #95 Satin Black.
- Maximum weight capacity is 350 lbs. for single seat benches, 700 lbs. for two-seat models and 1050 lbs. for three-seat units.
- Center table manufactured in Beech.
- Two table surface options: Beech veneer or laminate.
- All standard and custom wood finishes available on Beech.
- For custom wood finishes, please add one-time upcharge of \$400 List per color per order.
- For standard laminates, refer to Standard Finish Card.
- For custom laminates, add \$500 List per color per order. Pre-approval required, please contact Customer Service.
- Non-skid glides available for hard surface floors. Please specify “-NS08” after model number and add \$25 List per unit.
- Two-tone upholstery examples and yardage requirements featured on page 3.
- **Note: Legs must be field installed.**

HUSH BENCHES

designed by 5d studio



NOTES:

- Fixed legs available in #06 Charcoal Grey, #90 Metallic Silver, #92 Polished Aluminum and #95 Satin Black.
- Two table surface options: Beech veneer or laminate.

SPECIFY:

1. Model number
2. Leg finish
3. Upholstery selection
4. Table finish, as applicable
5. Options, as applicable

ORDERING EXAMPLE:

#8301-NS08
Single Seat Bench
Non-Skid Glides

SIN #711-16

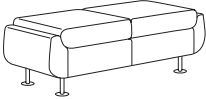
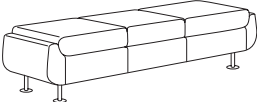
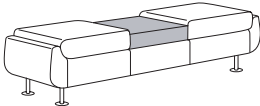
MODEL NUMBER	PRODUCT SPECIFICATIONS	FABRIC GRADES								LEATHER GRADES			
		COM	1	2	COL			7	8	L1	L2	L3	
8302	 <p>Two-Seat Bench W 54 D 21 H 17½ 3½ Yds. 59 lbs. COL 70 Sq. Ft. TB 133, add \$168 List</p>	1451	1650	1698	1782	1867	1948	2032	2109	2194	2580	2863	3138
8303	 <p>Three-Seat Bench W 79 D 21 H 17½ 4½ Yds. 81 lbs. COL 90 Sq. Ft. TB 133, add \$216 List</p>	1876	2132	2193	2302	2410	2514	2623	2722	2831	3327	3691	4045
8303-T	 <p>Two-Seat Bench with Center Table W 79 D 21 H 17½ Table Height: 16" 3½ Yds. 94 lbs. COL 70 Sq. Ft. TB 133, add \$168 List</p>	2042	2241	2289	2373	2458	2539	2623	2700	2785	3171	3454	3729

OPTIONS (XXXX - REFERS TO BENCH MODEL NUMBER)

MODEL	DESCRIPTION	LIST
XXXX-NS08	Non-Skid Glides	25

UPHOLSTERY COMBINATIONS:

For fabric vinyl or leather upholstery combinations refer to the pricing below:

- When combining **two** COM/COV/COL fabrics or fabrics with the same grade price will be \$65 List (per unit).
- When combining **three or more** COM/COV/COL fabrics or fabrics with the same grade price will be \$75 List (per unit).
- When combining different grades of fabric price will be based on the highest grade specified.

- Two-tone upholstery examples and yardage requirements for the most common combinations are listed below. Additional combinations available please contact Customer Service for yardage requirements and pricing.
- Note: Yardage amounts are based on fabric which is plain (i.e. non-directional) and a full 54" wide.
- **Appropriate upholstery code must be included on order.**

HUSH BENCHES

designed by 5d studio



SIN #711-16

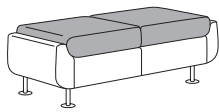

Code HB2
Model COM Requirement
 8302 Seat Cushion Only = 1³/₄ yds.
 Balance of Bench = 1³/₄ yds.

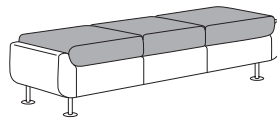

Code HB3
Model COM Requirement
 8303 Seat Cushion Only = 2¹/₂ yds.
 Balance of Bench = 2 yds.

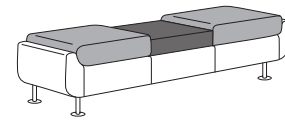

Code HB4
Model COM Requirement
 8303-T Seat Cushion Only = 1³/₄ yds.
 Balance of Bench = 2 yds.

HUSH LOUNGE

designed by 5d studio



SIN #711-16

PRODUCT FEATURES:

- Fixed seat cushion.
- Fixed leg dimensions: 4" Dia. x 5" H.
- Four fixed leg finish options: #06 Charcoal Grey, #90 Metallic Silver, #92 Polished Aluminum or #95 Satin Black.
- Legs feature 1" maximum height adjustability for leveling purposes.
- Non-skid glides available for hard surface floors. Please specify "NS08B" after model number and add \$25 List per unit.
- Maximum weight capacity of 350 lbs.
- Please refer to page 3 for two-tone upholstery examples, yardage requirements and pricing.
- **Note: Legs must be field installed.**
- All dimensions are nominal.

ROTATING TABLET:

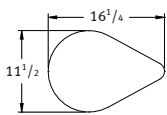

Tablet Shape



Wood/Laminate/Corian Top - Edge Profile

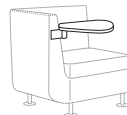

Chair Mounting Bracket Placement

- Tablet size is 16¹/₄" L x 11¹/₂" D x 3³/₄" thick with 270-degree tablet turning radius.
- Three tablet surface options: Beech veneer, laminate and Corian.
- All standard and custom wood finishes available on Beech.
- For custom wood finishes, please add one-time upcharge of \$400 List per color per order.
- Laminate is applied to tablet top surface only.
- For standard laminates, refer to Standard Finish Card.
- For custom laminates, add \$500 List per color per order. Pre-approval required, please contact Customer Service.
- Corian available in four standard colors. For non-standard options, please contact Customer Service for pricing.
- Tablet mounting bracket finished in #92 Polished Aluminum.

TABLET EDGE FINISH SPECIFICATIONS:

- For veneer tops, edge finish will always match the top finish color, unless otherwise specified.
- For standard laminate tops (laminate cannot be applied to the edge):
 - › Wood grain laminates, edge finish will match the laminate top color, unless otherwise specified.
 - › All solid color laminates, edge finish will be natural (clear coat) as standard, unless otherwise specified.
- For Corian tops:
 - › Designer White, Rain Cloud and Linen colors, edge will be white as standard, unless otherwise specified.
 - › Witch Hazel, edge will be natural (clear coat) as standard, unless otherwise specified.
- Edges are also available in all standard wood finishes, please specify. For custom edge finishes, please add one-time upcharge of \$400 List per color, per order.

CUP HOLDER:

- Dimensions: 5" outer diameter, 3¹/₂" inner diameter (cup size) x 1¹/₄" deep.
- Cup holder mounting bracket finished in #92 Polished Aluminum and features black leather insert.

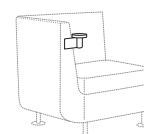

HUSH LOUNGE

designed by 5d studio



SIN #711-16

NOTES:

- Fixed legs available in #06 Charcoal Grey, #90 Metallic Silver, #92 Polished Aluminum and #95 Satin Black.
- Swivel base available in Polished Stainless Steel only and features auto-return as standard.
- Refer to page 3 for two-tone upholstery examples and yardage requirements.
- **Note: Legs must be field installed.**

SPECIFY:

1. Model number
2. Leg finish
3. Upholstery selection
4. Options, as applicable

ORDERING EXAMPLE:

#5551-TAR10-NS08

Lounge Chair
Veneer Tablet, Right
Non-Skid Glides

MODEL NUMBER	PRODUCT SPECIFICATIONS	FABRIC GRADES							LEATHER GRADES				
		COM	1	2	COL			4	5	6	7	8	L1
5551	 Lounge Chair, Public (low back) W 34 ¹ / ₄ D 30 H 31 Seat Height 17 ¹ / ₂ Inside Seat Width 24 Inside Seat Depth 20 ¹ / ₄ 5 ³ / ₄ Yds. 77 lbs. COL 115 Sq. Ft. TB 133, add \$276 List	1565	1892	1970	2109	2248	2381	2519	2646	2785	3419	3884	4337
5551-AR	 Lounge Chair, Swivel Base, Public (low back) W 34 ¹ / ₄ D 30 H 31 Seat Height 17 ¹ / ₂ Inside Seat Width 24 Inside Seat Depth 20 ¹ / ₄ 5 ³ / ₄ Yds. 77 lbs. COL 115 Sq. Ft. TB 133, add \$276 List	1715	2042	2120	2259	2398	2531	2669	2796	2935	3569	4034	4487
5552	 Love Seat, Public (low back) W 54 ¹ / ₂ D 30 H 31 Seat Height 17 ¹ / ₂ Inside Seat Width 44 ¹ / ₂ Inside Seat Depth 20 ¹ / ₂ 7 ¹ / ₄ Yds. 102 lbs. COL 145 Sq. Ft. TB 133, add \$348 List	2054	2466	2565	2740	2915	3082	3257	3417	3592	4392	4978	5549
5553	 Sofa, Public (low back) W 76 ¹ / ₂ D 30 H 31 Seat Height 17 ¹ / ₂ Inside Seat Width 66 ¹ / ₂ Inside Seat Depth 20 ¹ / ₂ 9 Yds. 126 lbs. COL 180 Sq. Ft. TB 133, add \$432 List	2770	3281	3404	3621	3838	4046	4264	4462	4679	5672	6399	7108
5581	 Lounge Chair, Private (high back) W 36 ¹ / ₂ D 33 ¹ / ₂ H 45 ¹ / ₂ Seat Height 17 ¹ / ₂ Inside Seat Width 26 Inside Seat Depth 20 ¹ / ₂ 8 ¹ / ₂ Yds. 97 lbs. COL 170 Sq. Ft. TB 133, add \$408 List	2129	2611	2727	2933	3138	3334	3540	3727	3932	4869	5557	6226

OPTIONS (XXXX - REFERS TO CHAIR MODEL NUMBER)

MODEL	DESCRIPTION	LIST
XXXX-TAR10	Veneer/Laminate Rotating Tablet, Right (as seated)	332
XXXX-TAL10	Veneer/Laminate Rotating Tablet, Left (as seated)	332
XXXX-TAR10-CO	Corian Rotating Tablet, Right (as seated)	635
XXXX-TAL10-CO	Corian Rotating Tablet, Left (as seated)	635
XXXX-CHR01	Outside Mounted Cup Holder, Right (as seated)	150
XXXX-CHL01	Outside Mounted Cup Holder, Left (as seated)	150
XXXX-NS08B	Non-Skid Glides	25

UPHOLSTERY COMBINATIONS:

For fabric, vinyl or leather upholstery combinations, refer to the pricing below:

- When combining **two** COM/COV/COL fabrics, or fabrics with the same grade, add the following (per unit):
 - › \$65 List for lounge chairs
 - › \$105 List for love seats
 - › \$130 List for sofas
- When combining **three or more** COM/COV/COL fabrics, or fabrics with the same grade, add the following (per unit):
 - › \$75 List for lounge chairs
 - › \$115 List for love seats
 - › \$140 List for sofas
- When combining different grades of fabric, price will be based on the highest grade specified.
- Two-tone upholstery examples and yardage requirements for the most common combinations are listed below. Additional combinations available, please contact Customer Service for yardage requirements and pricing.
- Note: Yardage amounts are based on fabric which is plain (i.e. non-directional) and a full 54" wide.
- **Appropriate upholstery code must be included on order.**

HUSH LOUNGE

designed by 5d studio

SIN #711-16



Code HS1

Model COM Requirement
 5551 Seat Cushion Only = 1 yd.
 5551-S Balance of Chair = 5 yds.



Code HS2

Model COM Requirement
 5552 Seat Cushion Only = 1¹/₂ yds.
 Balance of Love Seat = 6 yds.

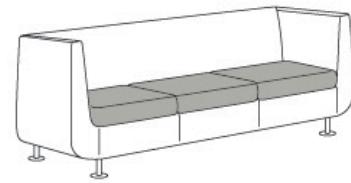

Code HS3

Model COM Requirement
 5553 Seat Cushion Only = 2¹/₄ yds.
 Balance of Sofa = 7 yds.



Code HS8

Model COM Requirement
 5581 Seat Cushion Only = 1 yd.
 Balance of Chair = 7¹/₂ yds.



Code HS9

Model COM Requirement
 5581 Headrest = 3 yds.
 Balance of Chair = 5³/₄ yds.

HUSH MEETING TABLES

designed by 5d studio



SIN #711-11

PRODUCT FEATURES:

- 29" and 39" standard table heights. Custom heights between 29" - 39" available, please specify and add \$200 List upcharge per unit. Price is based on the higher standard table height (e.g. 28" custom height, price is based on the 29" standard height plus \$200).
- Three table surface options: Beech veneer, laminate or Corian. All standard and custom wood finishes available on Beech.
- For custom wood finishes, please add \$400 List per color per order.
- Laminate is applied to table top surface only. For standard laminates, refer to Standard Finish Card.
- For custom laminates, add \$500 List per color per order. Pre-approval required, please contact Customer Service.
- For Corian top, specify "-CO" next to model number. Corian top is $\frac{1}{2}$ " thick in lieu of standard table top thickness of $\frac{3}{4}$ ".
- Corian top available in four standard colors. For non-standard colors, please contact Customer Service for pricing.
- Base available in all standard and premium metal finishes.
- Bases feature adjustable black glides.
- All dimensions are nominal.

CORIAN® COLORS:

Designer White
Rain Cloud
Linen
Witch Hazel

Corian® is a registered trademark of Dupont.

STANDARD BASE FINISH COLORS:

#06 Charcoal Grey
#90 Metallic Silver
#91 Chrome
#95 Satin Black

PREMIUM BASE FINISH COLORS:

#07 Gold Shimmer #83 Metallic Champagne
#08 Penny #94 Cotton
#09 Brown Sugar

EDGE FINISH SPECIFICATIONS:

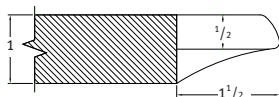

Veneer Top/Wood Edge

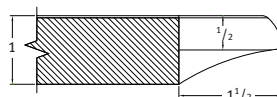

Laminate Top/Exposed Wood Edge

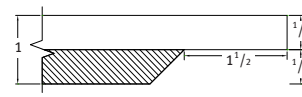

Corian Top/Exposed Wood Edge

- For veneer tops, edge finish will always match the top finish color, unless otherwise specified.
- For standard laminate tops (laminate cannot be applied to the edge):
 - › Wood grain laminates, edge finish will match the laminate top color, unless otherwise specified.
 - › Solid color laminates, edge finish will be natural (clear coat) as standard, unless otherwise specified.
- For Corian tops:
 - › Designer White, Rain Cloud and Linen colors, edge will be white as standard, unless otherwise specified.
 - › Witch Hazel, edge will be natural (clear coat) as standard, unless otherwise specified.
- Edges are also available in all standard wood finishes, please specify. For custom edge finishes, please add one-time upcharge of \$400 List per color, per order.

HUSH MEETING TABLES

designed by 5d studio



SIN #711-11

NOTES:





- 29" and 39" standard table heights.
- Three table surface options: Beech veneer, laminate or Corian.
- For Corian top, specify "-CO" next to model number. Corian top is 1/2" thick in lieu of standard table top thickness of 3/4" .

SPECIFY:

1. Model number
2. Table top finish
3. Edge detail, as applicable
4. Base finish

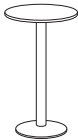
ORDERING EXAMPLE:

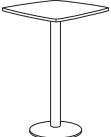
#HT-3029-CO-PF03
30" Round Hush Table
Corian Top
Premium Base Finish

TABLE TOP FINISH							
	TOP SIZES	MODEL NUMBER	VENEER OR LAMINATE	CORIAN (-CO)	COLUMN DIAMETER	BASE DIAMETER	WEIGHT
	Round, 29" Table Height						
	22" Dia.	HT-2229	1250	1852	3"	16"	30
	30" Dia.	HT-3029	1713	2658	4"	20"	60
	36" Dia.	HT-3629	2201	3774	4"	23"	80
	42" Dia.	HT-4229	2795	5050	4"	28"	105
	Round, 39" Table Height						
	22" Dia.	HT-2239	1330	1983	4"	16"	35
	30" Dia.	HT-3039	1809	2823	4"	20"	65
	36" Dia.	HT-3639	2317	3980	4"	23"	85
	Convex/Convex Square 29" Table Height						
	22" x 22"	HT-222229	1271	1873	3"	16"	35
	30" x 30"	HT-303029	1696	2639	4"	20"	65
	36" x 36"	HT-363629	2168	3741	4"	23"	85
	42" x 42"	HT-424229	2771	5027	4"	28"	105
	Convex/Convex Square 39" Table Height						
	22" x 22"	HT-222239	1320	1972	4"	16"	39
	30" x 30"	HT-303039	1798	2814	4"	20"	69
	36" x 36"	HT-363639	2309	3972	4"	23"	89
	Convex/Convex Rectangle 29" Table Height						
	30" x 60"	HT-306029	3191	5475	4"	20"	170
	36" x 72"	HT-367229	4108	7260	4"	23"	200

OPTIONS (XXXX - REFERS TO TABLE MODEL NUMBER)

MODEL	DESCRIPTION	LIST
XXXX-PF03	Premium Base Finish, 1 Base	110
XXXX-PF06	Premium Base Finish, 2 Bases	220



HUSH MODULAR

designed by 5d studio



SIN #711-16

PRODUCT FEATURES:

- Two back options: low back (public) or high back (private).
- Arm and armless models available.
- Fixed seat cushion.
- Fixed leg dimensions: 4" Dia. x 5" H.
- Four fixed leg finish options: #06 Charcoal Grey, #90 Metallic Silver, #92 Polished Aluminum or #95 Satin Black.
- Legs feature 1" maximum height adjustability for leveling purposes.
- Non-skid glides available for hard surface floors. Please specify “-NS08B” after model number and add \$25 List per unit.
- Lounge chairs available individually or in modular combinations.
- Low back models available with connecting tables for expanded modular options.
- All standard and custom wood finishes available on Beech.
- For custom wood finishes (to connecting tables and/or tablets), please add one-time upcharge of \$400 List per color per order.
- For standard laminates, refer to Standard Finish Card.
- For custom laminates, add \$500 List per color per order. Pre-approval required, please contact Customer Service.
- Maximum weight capacity is 350 lbs. for lounge chairs (or per individual seat as applicable), 700 lbs. for love seats and 1000 lbs. for sofas.
- Please refer to page 10 for two-tone upholstery examples, yardage requirements and pricing.
- **Note: Legs must be field installed on all individual models and modular configurations.**
- All dimensions are nominal.

END AND IN-LINE CONNECTING TABLE PRODUCT FEATURES:

- **Configurable with public (low back) models only.**
- Available in three sizes: 12" wide straight, 23" wide straight and quarter-round.
- Three table surface options: Beech veneer, laminate or Corian.
- All standard and custom wood finishes available on Beech.
- For custom wood finishes (to connecting tables and/or tablets), please add one-time upcharge of \$400 List per color per order.
- For standard laminates, refer to Standard Finish Card.
- For custom laminates, add \$500 List per color per order. Pre-approval required, please contact Customer Service.
- Corian top also offered, specify “-CO” next to model number. Corian top is 1/2" thick in lieu of standard table top thickness of 3/4".
- Corian top available in four standard colors. For non-standard colors, please contact Customer Service for pricing.
- **Table with laminate or Corian top, finish selection for table body must be specified.**
- End tables feature two fixed legs in the following finish options: #06 Charcoal Grey, #90 Metallic Silver, #92 Polished Aluminum or #95 Satin Black.
- All dimensions are nominal.

CORIAN® COLORS:

Designer White
Linen
Rain Cloud
Witch Hazel

Corian® is a registered trademark of Dupont.

HUSH MODULAR

designed by 5d studio



SIN #711-16

CORNER UNIT PRODUCT FEATURES:

- Upholstery direction must be specified on corner upholstered units when patterned fabrics are selected. In the absence of specific instructions, Arcadia reserves the right to upholster units at our discretion.

Up the roll

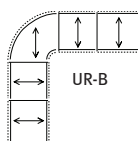
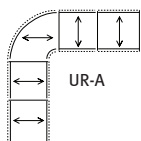

Railroaded

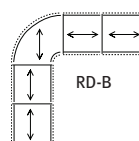
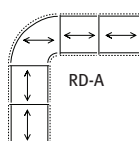

MODULAR ARRANGEMENTS:

- For modular configurations, lounge units are connected together using shared legs.
- Units ordered that will not be connected to other units will require additional legs. Please add \$35 List per leg.
- Field assembly required.
- Note: Please include layout drawings or sketch with each order.**

ROTATING TABLET:

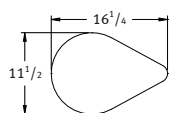

Tablet Shape



Wood/Laminate/Corian Top - Edge Profile

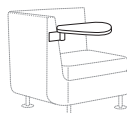

Chair Mounting Bracket Placement

- Available on private and public right/left arm end-units and specified connecting tables.
- Tablet size is $16\frac{1}{4}$ " L x $11\frac{1}{2}$ " D x $\frac{3}{4}$ " thick.
- 270-degree tablet turning radius on right/left arm end-units.
- 360-degree tablet turning radius on connecting tables.
- Three tablet surface options: Beech veneer, laminate and Corian.
- All standard and custom wood finishes available on Beech.
- For custom wood finishes (to connecting tables and/or tablets), please add one-time upcharge of \$400 List per color per order.
- Laminate is applied to tablet top surface only.
- For standard laminates, refer to Standard Finish Card.
- For custom laminates, add \$500 List per color per order. Pre-approval required, please contact Customer Service.
- Corian available in four standard colors. For non-standard options, please contact Customer Service for pricing.
- Tablet mounting bracket on modular right/left arm end units finished in #92 Polished Aluminum.
- Tablet mounting post featured on connecting tables available in four finishes: #06 Charcoal Grey, #90 Metallic Silver, #91 Chrome and #95 Satin Black.

HUSH MODULAR

designed by 5d studio



SIN #711-16

TABLET EDGE FINISH SPECIFICATIONS:

- For veneer tops, edge finish will always match the top finish color, unless otherwise specified.
- For standard laminate tops (laminate cannot be applied to the edge):
 - › Wood grain laminates, edge finish will match the laminate top color, unless otherwise specified.
 - › Formica Brite White laminate, edge finish will be white as standard, unless otherwise specified.
 - › All solid color laminates, edge finish will be natural (clear coat) as standard, unless otherwise specified.
- For Corian tops:
 - › Designer White, Rain Cloud and Linen colors, edge will be white as standard, unless otherwise specified.
 - › Witch Hazel, edge will be natural (clear coat) as standard, unless otherwise specified.
- Edges are also available in all standard wood finishes, please specify. For custom edge finishes, please add one-time upcharge of \$400 List per color, per order.

CUP HOLDER:

- Available on right/left arm end units.
- Dimensions: 5" outer diameter, 3¹/₂" inner diameter (cup size) x 1¹/₄" deep.
- Cup holder mounting bracket finished in #92 Polished Aluminum and features black leather insert.

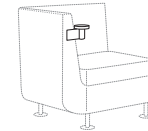

POWER UNITS:

- Available on all connecting tables.
- PB1 and PB2 dimensions: 5³/₄" W x 2¹/₂" D
- PB3 dimensions: 6¹/₂" W x 2¹/₂" D
- Metallic Silver or White finish with 108" electrical cord.
- UL listed.



PB1

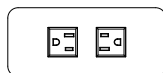

PB2

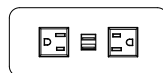

PB3

- PB1 unit features one outlet and two USB charging ports.
- PB2 unit features two outlets.
- PB3 unit features two outlets and two USB charging ports.

HUSH MODULAR

designed by 5d studio



SIN #711-16

NOTES:

- For modular configurations, lounge units are connected using shared legs.
- Units ordered that will not be connected to other units will require additional legs. Please add \$35 List per leg.
- Fixed legs available in #06 Charcoal Grey, #90 Metallic Silver, #92 Polished Aluminum and #95 Satin Black.
- Refer to pages 5-7 connecting table options.
- Refer to page 10 for two-tone upholstery examples and yardage requirements.
- **Note: Legs must be field installed.**

SPECIFY:





1. Model number
2. Leg finish
3. Upholstery selection
4. Options, as applicable

Please include layout drawing or sketch with each order.

ORDERING EXAMPLE:

#5560-R-TAR10

Public Lounge, Right Arm End Unit
Veneer Tablet, Right

MODEL NUMBER	PRODUCT SPECIFICATIONS	FABRIC GRADES							LEATHER GRADES							
		COM	1	2	COL			3	4	5	6	7	8	L1	L2	L3
5560	 <p>Modular Lounge Unit, Public (low back) In-Line Armless Unit W 23 D 30 H 31 Seat Height 17¹/₂ Inside Seat Width 22¹/₂ Inside Seat Depth 20¹/₄ 3 Yds. 42 lbs. COL 60 Sq. Ft. TB 133, add \$144 List</p>	1325	1496	1537	1609	1681	1751	1823	1889	1962	2293	2535	2771			
5560-R	 <p>Modular Lounge Unit, Public (low back) Right Arm End Unit (as seated) W 30 D 30 H 31 Seat Height 17¹/₂ Inside Seat Width 24 Inside Seat Depth 20¹/₄ 4¹/₄ Yds. 48 lbs. COL 85 Sq. Ft. TB 133, add \$204 List</p>	1622	1863	1921	2024	2127	2225	2328	2421	2524	2992	3336	3671			
5560-L	 <p>Modular Lounge Unit, Public (low back) Left Arm End Unit (as seated) W 30 D 30 H 31 Seat Height 17¹/₂ Inside Seat Width 24 Inside Seat Depth 20¹/₄ 4¹/₄ Yds. 48 lbs. COL 85 Sq. Ft. TB 133, add \$204 List</p>	1622	1863	1921	2024	2127	2225	2328	2421	2524	2992	3336	3671			
5560-C	 <p>Modular Lounge Unit, Public (low back) Corner Unit W 30 D 30 H 31 Seat Height 17¹/₂ Inside Seat Width 20¹/₄ Inside Seat Depth 20¹/₄ 4¹/₄ Yds. 52 lbs. COL 85 Sq. Ft. TB 133, add \$204 List</p>	1622	1863	1921	2024	2127	2225	2328	2421	2524	2992	3336	3671			

OPTIONS (XXXX - REFERS TO CHAIR MODEL NUMBER)

MODEL	DESCRIPTION	LIST
XXXX-TAR10	Veneer/Laminate Rotating Tablet, Right (as seated)	332
XXXX-TAL10	Veneer/Laminate Rotating Tablet, Left (as seated)	332
XXXX-TAR10-CO	Corian Rotating Tablet, Right (as seated)	635
XXXX-TAL10-CO	Corian Rotating Tablet, Left (as seated)	635
XXXX-CHR01	Outside Mounted Cup Holder, Right (as seated)	150
XXXX-CHL01	Outside Mounted Cup Holder, Left (as seated)	150
XXXX-NS08B	Non-Skid Glides	25

NOTES:

- **Configurable with public (low back) models only.**
- Three table surface options: Beech veneer, laminate or Corian.
- Corian top is 1/2" thick in lieu of standard table top thickness of 3/4".
- **Table with laminate or Corian top, finish selection for table body must be specified.**
- Tablet post is positioned 5 1/2" from front of table.

SPECIFY:

1. Model number
2. Top finish
3. Body finish
4. Leg finish, as applicable
5. Tablet and post finish, as applicable
6. Options, as applicable

Please include layout drawing or sketch with each order.

ORDERING EXAMPLE:

#5512-TAC03-PB1-S

12" In-Line Table with Veneer
Rotating Tablet
Power Band 1 Unit, Silver

HUSH MODULAR

designed by 5d studio

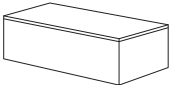
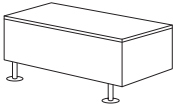

SIN #711-16

MODEL NUMBER	PRODUCT SPECIFICATIONS	TABLE TOP FINISH	
		VENEER OR LAMINATE	CORIAN (-CO)
5512 	12" In-Line Table W 12 D 25 1/2 H 15 16 lbs.	917	1313
5515 	12" Right/Left End Table with Legs W 12 D 25 1/2 H 15 17 lbs.	985	1380

OPTIONS (XXXX - REFERS TO TABLE MODEL NUMBER)

MODEL	DESCRIPTION	LIST
XXXX-TAC03	Veneer/Laminate Rotating Tablet, Center	300
XXXX-TAC03-CO	Corian Rotating Tablet, Center	603
XXXX-PB1-S	Power Band 1 (one power, two USB), Silver	413
XXXX-PB1-W	Power Band 1 (one power, two USB), White	413
XXXX-PB2-S	Power Band 2 (dual power), Silver	322
XXXX-PB2-W	Power Band 2 (dual power), White	322
XXXX-PB3-S	Power Band 3 (dual power, two USB), Silver	429
XXXX-PB3-W	Power Band 3 (dual power, two USB), White	429
XXXX-NS08A	Non-Skid Glides	15

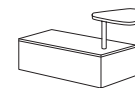

Tablet, Center

HUSH MODULAR

designed by 5d studio



NOTES:

- Configurable with public (low back) models only.
- Three table surface options: Beech veneer, laminate or Corian.
- Corian top is 1/2" thick in lieu of standard table top thickness of 3/4".
- Table with laminate or Corian top, finish selection for table body must be specified.
- Table post is positioned 2 1/2" x 2 1/2" from corner closest to seating unit.

SPECIFY:

1. Model number
2. Top finish
3. Body finish
4. Leg finish, as applicable
5. Tablet and post finish, as applicable
6. Options, as applicable

Please include layout drawing or sketch with each order.

ORDERING EXAMPLE:

#5523-CO-TAR12-PB1-S

23" In-Line Table, Corian Top, with Veneer Rotating Tablet Power Band 1 Unit, Silver

SIN #711-16

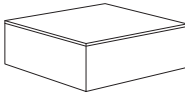
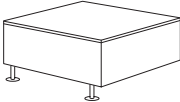
MODEL NUMBER	PRODUCT SPECIFICATIONS	TABLE TOP FINISH	
		VENEER OR LAMINATE	CORIAN (-CO)
5523 	23" In-Line Table W 22 1/2" D 25 1/2" H 15 34 lbs.	1147	1842
5525 	23" Right/Left End Table with Legs W 22 1/2" D 25 1/2" H 15 35 lbs.	1215	1909

OPTIONS (XXXX - REFERS TO TABLE MODEL NUMBER)

MODEL	DESCRIPTION	LIST
XXXX-TAR12	Veneer/Laminate Rotating Tablet, Right (as seated)	300
XXXX-TAL12	Veneer/Laminate Rotating Tablet, Left (as seated)	300
XXXX-TAR12-CO	Corian Rotating Tablet, Right (as seated)	603
XXXX-TAL12-CO	Corian Rotating Tablet, Left (as seated)	603
XXXX-PB1-S	Power Band 1 (one power, two USB), Silver	413
XXXX-PB1-W	Power Band 1 (one power, two USB), White	413
XXXX-PB2-S	Power Band 2 (dual power), Silver	322
XXXX-PB2-W	Power Band 2 (dual power), White	322
XXXX-PB3-S	Power Band 3 (dual power, two USB), Silver	429
XXXX-PB3-W	Power Band 3 (dual power, two USB), White	429

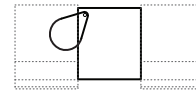

Tablet, Right

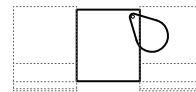

Tablet, Left

NOTES:

- **Configurable with public (low back) models only.**
- Three table surface options: Beech veneer, laminate or Corian.
- Corian top is 1/2" thick in lieu of standard table top thickness of 3/4".
- **Table with laminate or Corian top, finish selection for table body must be specified.**
- Tablet post is positioned 2 1/2" x 2 1/2" from corner closest to seating unit.

SPECIFY:

1. Model number
2. Top finish
3. Body finish
4. Leg finish
5. Tablet and post finish, as applicable
6. Options, as applicable

Please include layout drawing or sketch with each order.

ORDERING EXAMPLE:

#5545-CO-TAR12-CO-PB2-W

Quarter-Round Table with Corian Top and Corian Tablet
Power Band 2 Unit, White

HUSH MODULAR

designed by 5d studio

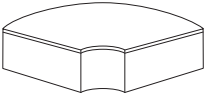

SIN #711-16

MODEL NUMBER	PRODUCT SPECIFICATIONS	TABLE TOP FINISH	
		VENEER OR LAMINATE	CORIAN (-CO)
5545	 <p>Quarter-Round Table W 32 D 32 H 15 39 lbs.</p>	1325	2947

OPTIONS (XXXX - REFERS TO TABLE MODEL NUMBER)

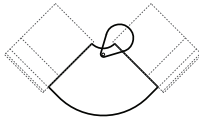
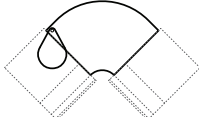
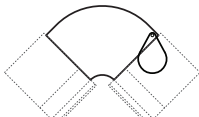
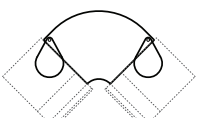
MODEL	DESCRIPTION	LIST	
XXXX-TAC03	Veneer/Laminate, Inside Wedge, Center	300	 <p>Tablet, Center</p>
XXXX-TAR12	Veneer/Laminate, Outside Wedge, Right (as seated)	300	
XXXX-TAL12	Veneer/Laminate, Outside Wedge, Left (as seated)	300	
XXXX-TAR12-TAL12	Veneer/Laminate, Outside Wedge, Right and Left	600	
XXXX-TAC03-CO	Corian, Inside Wedge, Center	603	 <p>Tablet, Right</p>
XXXX-TAR12-CO	Corian, Outside Wedge, Right (as seated)	603	
XXXX-TAL12-CO	Corian, Outside Wedge, Left (as seated)	603	
XXXX-TAR12-CO-TAL12-CO	Corian, Outside Wedge, Right and Left	1206	
XXXX-PB1-S	Power Band 1 (one power, two USB), Silver	413	 <p>Tablet, Left</p>
XXXX-PB1-W	Power Band 1 (one power, two USB), White	413	
XXXX-PB2-S	Power Band 2 (dual power), Silver	322	
XXXX-PB2-W	Power Band 2 (dual power), White	322	
XXXX-PB3-S	Power Band 3 (dual power, two USB), Silver	429	 <p>Tablet, Right & Left</p>
XXXX-PB3-W	Power Band 3 (dual power, two USB), White	429	

HUSH MODULAR

designed by 5d studio



NOTES:

- For modular configurations, lounge units are connected using shared legs.
- Units ordered that will not be connected to other units will require additional legs. Please add \$32 List per leg.
- Fixed legs available in #06 Charcoal Grey, #90 Metallic Silver, #92 Polished Aluminum and #95 Satin Black.
- Refer to page 10 for two-tone upholstery examples and yardage requirements.
- **Note: Legs must be field installed.**

SPECIFY:

1. Model number
2. Leg finish
3. Upholstery selection
4. Options, as applicable





Please include layout drawing or sketch with each order.

ORDERING EXAMPLE:

#5590-NS08B

Private Lounge, Armless
Non-Skid Glides

SIN #711-16

MODEL NUMBER	PRODUCT SPECIFICATIONS	FABRIC GRADES							LEATHER GRADES							
		COM	1	2	COL			3	4	5	6	7	8	L1	L2	L3
5590	 <p>Modular Lounge Unit, Private (high back) Armless In-Line Unit W 24¹/₂ D 33¹/₂ H 45¹/₂ Seat Height 17¹/₂ Inside Seat Width 24 Inside Seat Depth 20¹/₂ 3³/₄ Yds. 53 lbs. COL 75 Sq. Ft. TB 133, add \$180 List</p>	1697	1910	1961	2052	2142	2229	2320	2402	2493	2906	3209	3505			
5590-R	 <p>Modular Lounge Unit, Private (high back) Right Arm End Unit (as seated) W 31 D 33¹/₂ H 45¹/₂ Seat Height 17¹/₂ Inside Seat Width 24 Inside Seat Depth 20¹/₂ 5³/₄ Yds. 75 lbs. COL 115 Sq. Ft. TB 133, add \$276 List</p>	1914	2241	2319	2458	2597	2730	2868	2995	3134	3768	4233	4686			
5590-L	 <p>Modular Lounge Unit, Private (high back) Left Arm End Unit (as seated) W 31 D 33¹/₂ H 45¹/₂ Seat Height 17¹/₂ Inside Seat Width 24 Inside Seat Depth 20¹/₂ 5³/₄ Yds. 75 lbs. COL 115 Sq. Ft. TB 133, add \$276 List</p>	1914	2241	2319	2458	2597	2730	2868	2995	3134	3768	4233	4686			
5590-C	 <p>Modular Lounge Unit, Private (high back) Corner Unit W 33¹/₂ D 33¹/₂ H 45¹/₂ Seat Height 17¹/₂ Inside Seat Width 20¹/₂ Inside Seat Depth 20¹/₂ 5³/₄ Yds. 84 lbs. COL 115 Sq. Ft. TB 133, add \$276 List</p>	1914	2241	2319	2458	2597	2730	2868	2995	3134	3768	4233	4686			

OPTIONS (XXXX - REFERS TO CHAIR MODEL NUMBER)

MODEL	DESCRIPTION	LIST
XXXX-TAR10	Veneer/Laminate Rotating Tablet, Right (as seated)	332
XXXX-TAL10	Veneer/Laminate Rotating Tablet, Left (as seated)	332
XXXX-TAR10-CO	Corian Rotating Tablet, Right (as seated)	635
XXXX-TAL10-CO	Corian Rotating Tablet, Left (as seated)	635
XXXX-CHR01	Outside Mounted Cup Holder, Right (as seated)	150
XXXX-CHL01	Outside Mounted Cup Holder, Left (as seated)	150
XXXX-NS08B	Non-Skid Glides	25

HUSH MODULAR

designed by 5d studio



SIN #711-16

CONFIGURATION AND ORDERING EXAMPLES

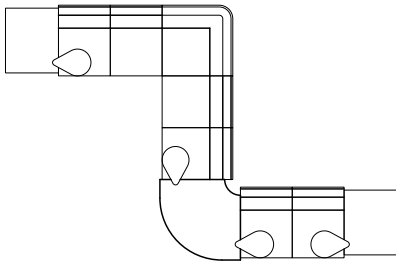

Qty	Model #	Description	COM List
1	5525-TAR12	23" End Table, Veneer Rotating Tablet Right (as seated)	1,515
6	5560	Modular Lounge, Public, Armless In-Line Unit (\$1,325 each)	7,950
1	5560-C	Modular Lounge, Public, Corner Unit	1,622
1	5545-TAR12-TAL12	Quarter-Round Table with Right and Left Rotating Tablet	1,925
1	5525-TAL12	23" End Table, Veneer Rotating Tablet Left (as seated)	1,515
10			14,527

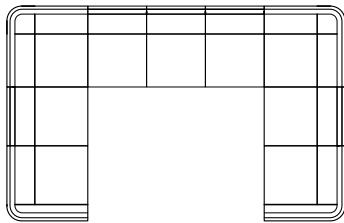

Qty	Model #	Description	COM List
1	5590-R	Modular Lounge, Private, Right Arm End Unit	1,914
5	5590	Modular Lounge, Private, Armless In-Line Unit (\$1,697 each)	8,485
2	5590-C	Modular Lounge, Private, Corner Unit (\$1,914 each)	3,828
1	5590-L	Modular Lounge, Private, Left Arm End Unit	1,914
9			16,141

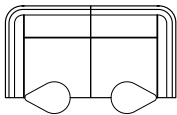

Qty	Model #	Description	COM List
1	5590-R-TAR10	Modular Lounge, Private, Right Arm End Unit with Veneer Rotating Tablet Right (as seated)	2,246
1	5590L-TAL10	Modular Lounge, Private, Left Arm End Unit with Veneer Rotating Tablet Left (as seated)	2,246
2			4,492

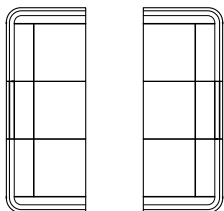

Qty	Model #	Description	COM List
2	5590-R	Modular Lounge, Private, Right Arm End Unit (\$1,914 each)	3,828
2	5590	Modular Lounge, Private, Armless In-Line Unit (\$1,697 each)	3,394
2	5590-L	Modular Lounge, Private, Left Arm End Unit (\$1,914 each)	3,828
6			11,050

HUSH MODULAR

designed by 5d studio

UPHOLSTERY COMBINATIONS:

For fabric, vinyl or leather upholstery combinations, refer to the pricing below:

- When combining **two** COM/COV/COL fabrics, or fabrics with the same grade, add \$65 List per unit.
- When combining **three or more** COM/COV/COL fabrics, or fabrics with the same grade, add \$75 List per unit.
- When combining different grades of fabric, price will be based on the highest grade specified.
- Two-tone upholstery examples and yardage requirements for the most common combinations are listed below. Additional combinations available, please contact Customer Service for yardage requirements and pricing.
- Note: Yardage amounts are based on fabric which is plain (i.e. non-directional) and a full 54" wide.
- **Appropriate upholstery code must be included on order.**

SIN #711-16



Code HS4
Model COM Requirement
5560 Seat Cushion Only = 1 yd.
Balance of Chair = 2 yds.



Code HS5
Model COM Requirement
5560-R Seat Cushion Only = 1 yd.
5560-L Balance of Chair = 3¹/₂ yds.



Code HS6
Model COM Requirement
5560-C Seat Cushion Only = 1 yd.
Balance of Chair = 3¹/₂ yds.



Code HS7
Model COM Requirement
5560 Inside/Outside Back = 1³/₄ yds.
Seat Cushion/Seat Box = 1¹/₂ yds.

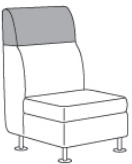

Code HS10
Model COM Requirement
5590 Headrest = 3³/₄ yd.
Balance of Chair = 3 yds.



Code HS11
Model COM Requirement
5590-R Headrest = 2 yds.
5590-L Balance of Chair = 4¹/₄ yds.



Code HS12
Model COM Requirement
5590-C Headrest = 2 yds.
Balance of Chair = 4¹/₄ yds.



Code HS13
Model COM Requirement
5590 Seat Cushion Only = 1 yd.
Balance of Chair = 3 yds.



Code HS14
Model COM Requirement
5590-R Seat Cushion Only = 1 yd.
5590-L Balance of Chair = 5¹/₄ yds.



Code HS15
Model COM Requirement
5590-C Seat Cushion Only = 1 yd.
Balance of Chair = 5¹/₄ yds.



Code HS16
Model COM Requirement
5590 Seat Cushion/Seat Box = 1¹/₂ yds.
Balance of Chair = 2¹/₂ yds.

INFINIUM BENCHES

designed by michael bemis



SIN #711-16

PRODUCT FEATURES:

- Offered individually and select models also available in modular combinations (free-standing applications only).
- Offered fully upholstered or with veneer or laminate body.
- Veneer options include Maple, Walnut and White Oak.
- All standard and custom finishes available.
- For custom wood finishes, please add one-time upcharge of \$400 List per color per order.
- For standard laminates, refer to Standard Finish Card.
- For custom laminates, add \$500 List per color per order. Pre-approval required, please contact Customer Service.
- Metal legs available in standard and premium finishes.
- For premium metal finishes, please refer to individual pages for applicable upcharge.
- Non-skid glides available for hard surface floors, please refer to individual pages for applicable upcharge.
- Please refer to page 4 for two-tone upholstery examples and yardage requirements.

STANDARD LEG FINISH COLORS:

#06 Charcoal Grey
#90 Metallic Silver
#92 Polished Aluminum
#95 Satin Black

PREMIUM LEG FINISH COLORS:

#07 Gold Shimmer #83 Metallic Champagne
#08 Penny #94 Cotton
#09 Brown Sugar

INFINIUM BENCHES

designed by michael bemis



SIN #711-16

NOTES:



- Available in Maple, Walnut and White Oak veneer as well as laminate selections.
- Straight and tapered benches available individually, or group together to create larger seating arrangements.
- Metal legs available in standard and premium finishes.
- Refer to page 4 for two-tone upholstery examples and yardage requirements.

SPECIFY:

- Model number
- Wood species, as applicable
- Wood finish, as applicable
- Leg finish
- Upholstery selection
- Options, as applicable

ORDERING EXAMPLE:

#3220-18-U-PF04
Straight Bench with Upholstered Seat and Body
Premium Leg Finish

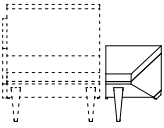
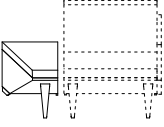
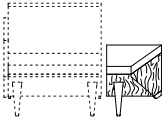
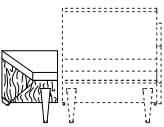
MODEL NUMBER	PRODUCT SPECIFICATIONS	FABRIC GRADES								LEATHER GRADES						
		COM	1	2	COL			4	5	6	7	8	L1	L2	L3	
3220-18-U 	Straight Bench with Upholstered Seat and Upholstered Body W 18 D 27 ¹ / ₄ H 17 ¹ / ₂ 2 yds. 40 lbs. COL 40 Sq. Ft. TB 133, add \$96 List	991	1105	1132	1180	1229	1275	1323	1367	1416	1636	1798	1955			
3220-18-V 	Straight Bench with Upholstered Seat and Veneer or Laminate Body W 18 D 27 ¹ / ₄ H 17 ¹ / ₂ 3/4 yd. 40 lbs. COL 15 Sq. Ft. TB 133, add \$36 List	1153	1196	1206	1224	1242	1260	1278	1294	1313	1395	1456	1515			
3220-20L-U 	Angled Bench, Tapered Left (as seated) with Upholstered Seat and Body W 18 D 27 ¹ / ₄ H 17 ¹ / ₂ 2 yds. 32 lbs. COL 40 Sq. Ft. TB 133, add \$96 List	873	987	1014	1062	1111	1157	1205	1249	1298	1518	1680	1837			
3220-20R-U 	Angled Bench, Tapered Right (as seated) with Upholstered Seat and Body W 18 D 27 ¹ / ₄ H 17 ¹ / ₂ 2 yds. 32 lbs. COL 40 Sq. Ft. TB 133, add \$96 List	873	987	1014	1062	1111	1157	1205	1249	1298	1518	1680	1837			
3220-20L-V 	Angled Bench, Tapered Left (as seated) with Upholstered Seat and Veneer or Laminate Body W 18 D 27 ¹ / ₄ H 17 ¹ / ₂ 3/4 yds. 32 lbs. COL 15 Sq. Ft. TB 133, add \$36 List	1050	1093	1103	1121	1139	1157	1175	1191	1210	1292	1353	1412			
3220-20R-V 	Angled Bench, Tapered Right (as seated) with Upholstered Seat and Veneer or Laminate Body W 18 D 27 ¹ / ₄ H 17 ¹ / ₂ 3/4 yds. 32 lbs. COL 15 Sq. Ft. TB 133, add \$36 List	1050	1093	1103	1121	1139	1157	1175	1191	1210	1292	1353	1412			

OPTIONS (XXXX - REFERS TO BENCH MODEL NUMBER)

MODEL	DESCRIPTION	LIST
XXXX-NS02A	Non-Skid Glides (2 rear and 1 front leg)	10
XXXX-NS02B	Non-Skid Glides (2 rear and 2 front legs)	20
XXXX-MB02	Moisture Barrier, Seat Only	95
XXXX-PF02	Leg Premium Finish (2 rear and 1 front leg)	80
XXXX-PF04	Leg Premium Finish (2 rear and 2 front legs)	135

NOTES:

- Available in Maple, Walnut and White Oak veneer as well as laminate selections.
- Metal legs available in standard and premium finishes.
- Refer to page 4 for two-tone upholstery examples and yardage requirements.

SPECIFY:

1. Model number
2. Wood species, as applicable
3. Wood finish, as applicable
4. Leg finish
5. Upholstery selection
6. Options, as applicable

ORDERING EXAMPLE:

#3220-3636-U-NS02B-PF04



36" Square Bench
Non-Skid Glides
Premium Leg Finish

INFINIUM BENCHES

designed by michael bemis

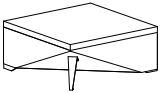

SIN #711-16

MODEL NUMBER	PRODUCT SPECIFICATIONS	FABRIC GRADES							LEATHER GRADES				
		COM	1	2	COL 3	4	5	6	7	8	L1	L2	L3
3220-3636-U 	36" Square Bench with Upholstered Seat and Body W 36 D 36 H 17 4 ¹ / ₂ yds. 83 lbs. COL 90 Sq. Ft. TB 133, add \$216 List	1275	1531	1592	1701	1809	1913	2022	2121	2230	2726	3090	3444
3220-3636-V 	36" Square Bench with Upholstered Seat and Veneer or Laminate Body W 36 D 36 H 17 1 ³ / ₄ yds. 83 lbs. COL 35 Sq. Ft. TB 133, add \$84 List	1493	1593	1617	1659	1701	1742	1784	1822	1865	2058	2199	2337

OPTIONS (XXXX - REFERS TO BENCH MODEL NUMBER)

MODEL	DESCRIPTION	LIST
XXXX-NS02B	Non-Skid Glides (2 rear and 2 front legs)	20
XXXX-MB03	Moisture Barrier, Seat Only	145
XXXX-PF04	Leg Premium Finish (2 rear and 2 front legs)	135

INFINIUM BENCHES

designed by michael bemis



UPHOLSTERY COMBINATIONS:

For fabric, vinyl or leather upholstery combinations, refer to the pricing below:

- When combining **two** COM/COV/COL fabrics, or fabrics with the same grade, add \$65 List per unit.
- When combining **three or more** COM/COV/COL fabrics, or fabrics with the same grade, add \$75 List per unit.
- When combining different grades of fabric, price will be based on the highest grade specified.
- Two-tone upholstery examples and yardage requirements for the most common combinations are listed below. Additional combinations available, please contact Customer Service for yardage requirements and pricing.
- Note: Yardage amounts are based on fabric which is plain (i.e. non-directional) and a full 54" wide.
- **Appropriate upholstery code must be included on order.**

SIN #711-16



Code	IF61
<u>Model</u>	<u>COM Requirement</u>
3220-18-U	Seat Cushion = 1 yd. Balance of Bench = 1 ¹ / ₂ yds.



Code	IF62
<u>Model</u>	<u>COM Requirement</u>
3220-20L-U 3220-20R-U	Seat Cushion = 1 yd. Balance of Bench = 1 ¹ / ₂ yds.

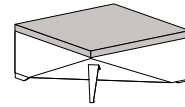

Code	IF63
<u>Model</u>	<u>COM Requirement</u>
3220-3636-U	Seat Cushion = 1 ¹ / ₂ yds. Balance of Bench = 3 yds.

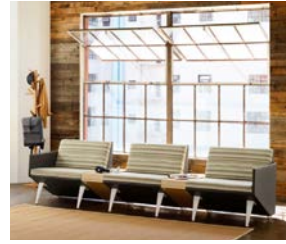

INFINIUM MODULAR

designed by michael bemis



SIN #711-16

PRODUCT FEATURES:

- Arm and armless lounge, love seat and sofa models available individually or in modular combinations with connecting or free-standing tables and/or free-standing benches.
- Intermediate arm option offered on love seat and sofa models, as well as lounge units, to continue a run of seating units with intermediate arms. Models with arms cannot be used next to a connecting table, nor can arms be retrofit to previously ordered armless units.
- 30¹/₂" and 40¹/₂" back height models.
- Fixed seat cushion.
- Metal legs available in standard and premium finishes, options listed below.
- For premium metal finishes, please refer to individual pages for applicable upcharge.
- Non-skid glides available for hard surface floors, please refer to individual pages for applicable upcharge.
- Maximum weight capacity is 350 lbs. for lounge chairs, 700 lbs. for love seats and 1000 lbs. for sofas.
- Please refer to pages 22-26 for two-tone upholstery examples and yardage requirements.
- All dimensions are nominal.

STANDARD LEG/SHELF POST FINISH COLORS:

#06 Charcoal Grey
#90 Metallic Silver
#92 Polished Aluminum
#95 Satin Black

PREMIUM LEG/SHELF POST FINISH COLORS:

#07 Gold Shimmer #83 Metallic Champagne
#08 Penny #94 Cotton
#09 Brown Sugar

PRIVACY PANELS:

- Available on arm and armless lounge chairs, love seats and sofas only (cannot be affixed to modular configurations with benches and/or tables).
- Privacy panels are 1/2" thick, 50" high from the floor and are offered with and without headrests.
- Four panel material options: veneer, laminate, whiteboard and upholstered.
- Veneer panels available in Maple, Walnut and White Oak wood species and feature vertical grain direction only.
- All standard and custom wood finishes available.
- For custom wood finishes (to panels, tables, shelf and/or benches), please add one-time upcharge of \$400 List per color per order.
- Veneer panels require veneer on both sides. As standard, the exposed radius plywood edge will be finished to match specified panel wood finish.
- Laminate panels will have same laminate on both sides as standard. For different laminate selections to the same panel, please contact Customer Service for pricing. If a wood grain laminate is specified, pattern will run horizontal with exposed plywood edge finished to match the laminate selection. If a non-wood grain laminate is specified, the exposed plywood edge will be finished in a clear coat as standard.
- Whiteboard panels will have same whiteboard material on both sides as standard. Also available with whiteboard surface on one side and a laminate surface on the other side, please specify and reference pricing for the whiteboard panels. The exposed plywood edge will be finished in a clear coat as standard.
- Upholstered panels available in fabric, vinyl or faux leather.
- Field installation required.
- Panels cannot be retrofit to previously ordered seating units.
- Panels are ordered separately from seating units. Please specify immediately following applicable seating unit.

INFINIUM MODULAR

designed by michael bemis

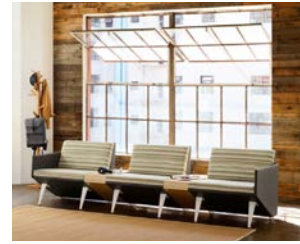

SIN #711-16

SHELF FEATURES:

- Shelf available in Maple, Walnut and White Oak, in all standard and custom wood finishes.
- For custom wood finishes (to shelf, privacy panels, tables and/or benches), please add one-time upcharge of \$400 List per color per order.
- Laminate shelf available.
- For standard laminates, refer to Standard Finish Card.
- For custom laminates, add \$500 List per color per order. Pre-approval required, please contact Customer Service.
- For veneer tops, edge finish will always match the top finish color, unless otherwise specified.
- For standard laminate tops (laminate cannot be applied to the edge):
 - › Wood grain laminates, edge finish will match the laminate top color, unless otherwise specified.
 - › All solid color laminates, edge finish will be natural (clear coat) as standard, unless otherwise specified.
- Shelf depth is 12".
- Shelf stands 30" from the floor for seated heights and 40" for standing heights.
- 150 lbs. maximum weight allowance (regardless of size).
- Metal support posts available in standard and premium finishes.
- Metal support posts will match standard finish legs unless otherwise specified.
- For premium metal finishes, specify color and add respective upcharge as listed on applicable pages.
- Shelf is ordered separately from seating units. Please specify immediately following applicable seating unit.
- Field installation required.

BENCHES:

- Offered individually and select models also available in modular combinations (free-standing applications only).
- Offered fully upholstered or with veneer or laminate body.
- Veneer options include Maple, Walnut and White Oak.
- All standard and custom finishes available.
- For custom wood finishes (to benches, shelf, privacy panels and/or tables), please add one-time upcharge of \$400 List per color per order.
- For standard laminates, refer to Standard Finish Card.
- For custom laminates, add \$500 List per color per order. Pre-approval required, please contact Customer Service.
- Metal legs available in standard and premium finishes.
- For premium metal finishes, please refer to individual pages for applicable upcharge.
- Non-skid glides available for hard surface floors, please refer to individual pages for applicable upcharge.
- Please refer to page 26 for two-tone upholstery examples and yardage requirements.

CONNECTING TABLES:

- Connecting tables include: straight (in-line or end), 20-degree angle, 30-degree angle, 45-degree angle and 90-degree corner table.
- Straight and 20-degree angled tables available in modular combinations as well as free-standing requirements. All other models can only be used in modular configurations (come standard with pre-drilled holes and without legs).
- Three table surface options: veneer, laminate or Corian.
- Veneer available in Maple, Walnut and White Oak, in all standard and custom wood finishes.
- For custom wood finishes (to tables, privacy panels, shelf and/or benches), please add one-time upcharge of \$400 List per color per order.



INFINIUM MODULAR

designed by michael bemis



SIN #711-16

CONNECTING TABLES CONTINUED:

- For standard laminates, refer to Standard Finish Card.
- For custom laminates, add \$500 List per color per order. Pre-approval required, please contact Customer Service.
- For Corian top, specify "-CO" next to model number. Corian top is affixed to table top surface increasing overall table height by $1/2$ ". Please note that a $1/8$ " reveal will be present.
- Corian top available in four standard colors. For non-standard colors, please contact Customer Service for pricing.
- **Table with Corian or laminate top, wood body species and finish selection must be specified.**
- Metal legs available in standard and premium finishes.
- For premium metal finishes, please refer to individual pages for applicable upcharge.
- Non-skid glides available for hard surface floors, please refer to individual pages for applicable upcharge.

CORIAN® COLORS:

Designer White
Linen
Rain Cloud
Witch Hazel

Corian® is a registered trademark of Dupont.

POWER UNITS:

- Available on individual arm and armless lounge, love seat and sofa models as well as tables.
- Unit is affixed to right side of seating units, as seated, unless otherwise specified.
- Unit will be positioned in the center of tables, 5" from the rear, as standard, unless otherwise specified.
- PB1 and PB2 dimensions: $5^{3/4}$ " W x $2^{1/2}$ " D
- PB3 dimensions: $6^{1/2}$ " W x $2^{1/2}$ " D
- Metallic Silver or White finish with 108" electrical cord.
- UL listed.



PB1

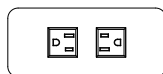

PB2

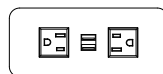

PB3

- PB1 unit features one outlet and two USB charging ports.
- PB2 unit features two outlets.
- PB3 unit features two outlets and two USB charging ports.

MODULAR ARRANGEMENTS (DOES NOT APPLY TO BENCHES):

- Ganging units, for both seating and tables, come standard with pre-drilled holes to accept linking connectors.
- For seat-to-table connections, units are bolted together via the connecting tables for easy, and discrete assembly. No tools or additional hardware required.
- To connect seating units together, a ganging leg is utilized in order to reduce the overall quantity of legs.
- **Note: Please include layout drawings or sketch with order.**
- Field assembly required.

INFINIUM MODULAR

designed by michael bemis



SIN #711-16

NOTES:

- Available individually or in modular combinations.
- **For modular arrangements, a layout drawing or sketch must accompany each order.**
- Refer to pages 22-23 for two-tone upholstery examples and yardage requirements.

SPECIFY:

1. Model number
2. Leg finish
3. Upholstery selection
4. Options, as applicable

ORDERING EXAMPLE:

#3201-PB1-S
Mid-Back Lounge, Armless
Power Band 1 Unit, Silver

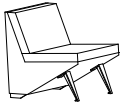
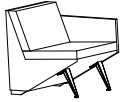
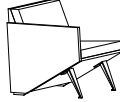
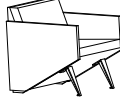
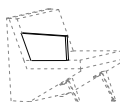
MODEL NUMBER	PRODUCT SPECIFICATIONS	FABRIC GRADES							LEATHER GRADES				
		COM	1	2	COL			6	7	8	L1	L2	L3
3201 	Mid-Back Lounge Chair, Armless W 30 D 29 ¹ / ₂ H 30 ¹ / ₂ Seat Height 17 ¹ / ₂ Inside Seat Width 30 Inside Seat Depth 19 ¹ / ₂ 4 yds. COL 80 sq. ft. 51 lbs. TB 133, add \$192 List	1382	1609	1664	1760	1857	1949	2046	2134	2231	2672	2995	3310
3201-LA 	Mid-Back Lounge, Left End Arm (as seated) W 31 ¹ / ₂ D 29 ¹ / ₂ H 30 ¹ / ₂ 5 ¹ / ₄ yds. COL 105 sq. ft. 66 lbs. TB 133, add \$252 List	1549	1847	1919	2046	2172	2294	2420	2536	2663	3242	3666	4080
3201-RA 	Mid-Back Lounge, Right End Arm (as seated) W 31 ¹ / ₂ D 29 ¹ / ₂ H 30 ¹ / ₂ 5 ¹ / ₄ yds. COL 105 sq. ft. 66 lbs. TB 133, add \$252 List	1549	1847	1919	2046	2172	2294	2420	2536	2663	3242	3666	4080
3201-LR 	Mid-Back Lounge, Left & Right Arm W 33 D 29 ¹ / ₂ H 30 ¹ / ₂ 6 ¹ / ₂ yds. COL 130 sq. ft. 81 lbs. TB 133, add \$312 List	1716	2085	2174	2331	2488	2638	2795	2938	3095	3812	4337	4849
3201-IAM 	Mid-Back Intermediate Arm (per arm) 1/2 yd. COL 10 sq. ft. TB 133, add \$24 List	113	142	149	161	173	184	196	207	220	275	315	354

OPTIONS (XXXX - REFERS TO CHAIR MODEL NUMBER)

MODEL	DESCRIPTION	LIST
XXXX-NS02B	Non-Skid Glides (2 rear and 2 front legs)	20
XXXX-MB02	Moisture Barrier, Seat Only (per lounge chair)	95
XXXX-PF04	Leg Premium Finish (2 rear and 2-3 front legs)	135
XXXX-PB1-S	Power Band 1 (one power, two USB), Silver	413
XXXX-PB1-W	Power Band 1 (one power, two USB), White	413
XXXX-PB2-S	Power Band 2 (dual power), Silver	322
XXXX-PB2-W	Power Band 2 (dual power), White	322
XXXX-PB3-S	Power Band 3 (dual power, two USB), Silver	429
XXXX-PB3-W	Power Band 3 (dual power, two USB), White	429

NOTES:

- Shelf and privacy panels ordered separately. Please specify immediately following applicable seating unit.
- 40" high shelf can only be specified together with privacy panel and headrest.
- For modular arrangements, a layout drawing or sketch must accompany each order.

SPECIFY:

1. Model number
2. Wood species, as applicable
3. Wood finish, as applicable
4. Shelf post finish, as applicable
5. Upholstery selection, as applicable

ORDERING EXAMPLE:

#3201-PB1-W
Mid-Back Lounge, Armless
Power Band 1 Unit, White

PR1U-HR1
Lounge Chair Privacy Panel
with Headrest

HS1-PF02
Lounge Chair Shelf, 40" High
Premium Post Finish

INFINIUM MODULAR

designed by michael bemis

SIN #711-16

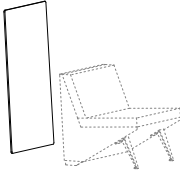
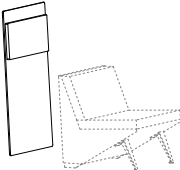
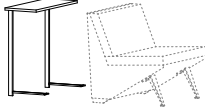
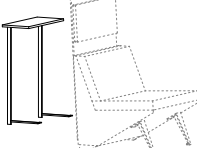
MODEL NUMBER	PRODUCT SPECIFICATIONS	PRIVACY PANEL MATERIAL	FABRIC GRADES							LEATHER GRADES					
			COL	1	2	3	4	5	6	7	8	L1	L2	L3	
PR1U (UPHOLSTERED) PR1V (VENEER) PR1L (LAMINATE) PR1W (WHITEBOARD) 	Lounge Privacy Panel W 29 ¹ / ₄ H 48 15 lbs. 2 ³ / ₄ yds. COL 55 sq. ft. TB 133, add \$132 List	upholstered	557	713	751	817	884	947	1014	1074	1141	1444	1666	1883	
		veneer or laminate	1008												
		whiteboard	1008												
PR1U-HR1 (UPHOLSTERED) PR1V-HR1 (VENEER) PR1L-HR1 (LAMINATE) PR1W-HR1 (WHITEBOARD) 	Lounge Chair Privacy Panel with Headrest W 29 ¹ / ₄ H 48 16 lbs. Upholstered Panel & Headrest*: 3 ¹ / ₂ yds. COL 70 sq. ft. TB 133, add \$168 List *refer to page 26 for two-tone requirements Non-Upholstered Panel & Headrest: 3/4 yd. COL 15 sq. ft. TB 133, add \$36 List	upholstered	619	818	866	950	1035	1116	1200	1277	1362	1748	2031	2306	
		veneer or laminate	1070	1113	1123	1141	1159	1177	1195	1211	1230	1312	1373	1432	
		whiteboard	1070	1113	1123	1141	1159	1177	1195	1211	1230	1312	1373	1432	
MS1 	Lounge Chair Shelf, 30" High W 28 ¹ / ₂ D 12 H 30 18 lbs. Available in Veneer or Laminate		571												
HS1 	Lounge Chair Shelf, 40" High Only available together with privacy panel and headrest W 28 ¹ / ₂ D 12 H 40 21 lbs. Available in Veneer or Laminate		580												

OPTIONS

MODEL	DESCRIPTION	LIST
XXXX-PF02	Shelf Post Premium Finish	80

INFINIUM MODULAR

designed by michael bemis



SIN #711-16

NOTES:

- Available individually or in modular combinations.
- **For modular arrangements, a layout drawing or sketch must accompany each order.**
- Refer to pages 22-23 for two-tone upholstery examples and yardage requirements.

SPECIFY:

1. Model number
2. Leg finish
3. Upholstery selection
4. Options, as applicable

ORDERING EXAMPLE:

#3202-PB1-S
Mid-Back Love Seat, Armless
Power Band 1 Unit, Silver

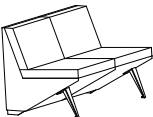
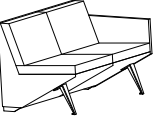
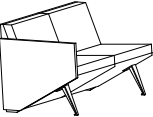
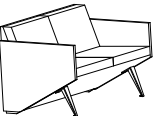
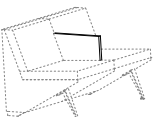
MODEL NUMBER	PRODUCT SPECIFICATIONS	FABRIC GRADES							LEATHER GRADES							
		COM	1	2	COL			3	4	5	6	7	8	L1	L2	L3
3202 	Mid-Back Love Seat, Armless W 60 D 29 ¹ / ₂ H 30 ¹ / ₂ Seat Height 17 ¹ / ₂ Inside Seat Width 60 Inside Seat Depth 19 ¹ / ₂ 7 ¹ / ₂ yds. COL 150 sq. ft. 86 lbs. TB 133, add \$360 List	1903	2329	2431	2612	2793	2967	3148	3313	3494	4321	4927	5518			
3202-LA 	Mid-Back Love Seat, Left End Arm (as seated) W 61 ¹ / ₂ D 29 ¹ / ₂ H 30 ¹ / ₂ 8 ³ / ₄ yds. COL 175 sq. ft. 101 lbs. TB 133, add \$420 List	2070	2567	2686	2897	3109	3311	3522	3715	3926	4891	5598	6288			
3202-RA 	Mid-Back Love Seat, Right End Arm (as seated) W 61 ¹ / ₂ D 29 ¹ / ₂ H 30 ¹ / ₂ 8 ³ / ₄ yds. COL 175 sq. ft. 101 lbs. TB 133, add \$420 List	2070	2567	2686	2897	3109	3311	3522	3715	3926	4891	5598	6288			
3202-LR 	Mid-Back Love Seat, Left & Right Arm W 63 D 29 ¹ / ₂ H 30 ¹ / ₂ 10 yds. COL 200 sq. ft. 116 lbs. TB 133, add \$480 List	2237	2804	2941	3182	3424	3655	3896	4117	4358	5461	6269	7057			
3201-IAM 	Mid-Back Intermediate Arm (per arm) 1/2 yd. COL 10 sq. ft. TB 133, add \$24 List	113	142	149	161	173	184	196	207	220	275	315	354			

OPTIONS (XXXX - REFERS TO CHAIR MODEL NUMBER)

MODEL	DESCRIPTION	LIST
XXXX-NS02B	Non-Skid Glides (2 rear and 2 front legs)	20
XXXX-MB03	Moisture Barrier, Seat Only (per love seat)	145
XXXX-PF04	Leg Premium Finish (2 rear and 2-3 front legs)	135
XXXX-PB1-S	Power Band 1 (one power, two USB), Silver	413
XXXX-PB1-W	Power Band 1 (one power, two USB), White	413
XXXX-PB2-S	Power Band 2 (dual power), Silver	322
XXXX-PB2-W	Power Band 2 (dual power), White	322
XXXX-PB3-S	Power Band 3 (dual power, two USB), Silver	429
XXXX-PB3-W	Power Band 3 (dual power, two USB), White	429

NOTES:

- Shelf and privacy panels ordered separately. Please specify immediately following applicable seating unit.
- 40" high shelf can only be specified together with privacy panel and headrest.
- For modular arrangements, a layout drawing or sketch must accompany each order.

SPECIFY:

1. Model number
2. Wood species, as applicable
3. Wood finish, as applicable
4. Shelf post finish, as applicable
5. Upholstery selection, as applicable

ORDERING EXAMPLE:

#3202-PB1-W
Mid-Back Love Seat, Armless
Power Band 1 Unit, White

#PR2U-HR2
Love Seat Privacy Panel with
Headrest

INFINIUM MODULAR

designed by michael bemis

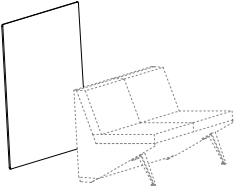
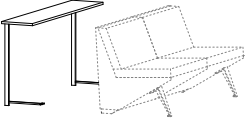
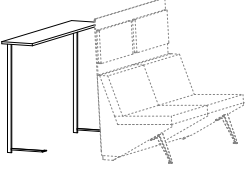

SIN #711-16

MODEL NUMBER	PRODUCT SPECIFICATIONS	PRIVACY PANEL MATERIAL	FABRIC GRADES								LEATHER GRADES				
			COL	1	2	3	4	5	6	7	8	L1	L2	L3	
PR2U (UPHOLSTERED) PR2V (VENEER) PR2L (LAMINATE) PR2W (WHITEBOARD)	Love Seat Privacy Panel W 59 ¹ / ₄ H 48 32 lbs. 5 ¹ / ₂ yds. COL 110 sq. ft. TB 133, add \$264 List	upholstered	679	991	1066	1199	1332	1459	1592	1713	1846	2452	2897	3330	
		veneer or laminate	1386												
		whiteboard	1386												
	Love Seat Privacy Panel with Headrest W 59 ¹ / ₄ H 48 32 lbs. Upholstered Panel & Headrest*: 6 ³ / ₄ yds. COL 135 sq. ft. TB 133, add \$324 List *refer to page 26 for two-tone requirements Non-Upholstered Panel & Headrest: 1 ¹ / ₄ yds. COL 25 sq. ft. TB 133, add \$60 List	upholstered	802	1185	1277	1440	1603	1759	1922	2071	2234	2978	3524	4056	
		veneer or laminate	1510	1581	1598	1629	1659	1688	1718	1745	1776	1913	2014	2113	
		whiteboard	1510	1581	1598	1629	1659	1688	1718	1745	1776	1913	2014	2113	
MS2	Love Seat Shelf, 30" High W 58 ¹ / ₂ D 12 H 30 36 lbs. Available in Veneer or Laminate		685												
	Love Seat Shelf, 40" Height Only available together with privacy panel and headrest W 58 ¹ / ₂ D 12 H 40 40 lbs. Available in Veneer or Laminate		693												
															

OPTIONS

MODEL	DESCRIPTION	LIST
XXXX-PF02	Shelf Post Premium Finish	80

INFINIUM MODULAR

designed by michael bemis



SIN #711-16

NOTES:

- Available individually or in modular combinations.
- **For modular arrangements, a layout drawing or sketch must accompany each order.**
- Refer to pages 22-23 for two-tone upholstery examples and yardage requirements.

SPECIFY:

1. Model number
2. Leg finish
3. Upholstery selection
4. Options, as applicable

ORDERING EXAMPLE:

#3203-RA-NS02C-PB1-S

Mid-Back Sofa, Right Arm
Non-Skid Glides
Power Band 1 Unit, Silver

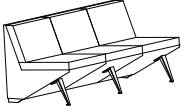
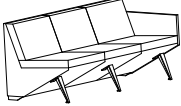
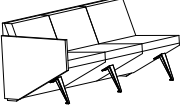
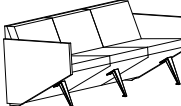
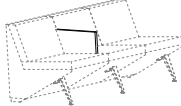
MODEL NUMBER	PRODUCT SPECIFICATIONS	FABRIC GRADES								LEATHER GRADES			
		COM	1	2	COL			6	7	8	L1	L2	L3
3203 	Mid-Back Sofa, Armless W 90 ³ / ₄ D 29 ¹ / ₂ H 30 ¹ / ₂ Seat Height 17 ¹ / ₂ Inside Seat Width 90 ¹ / ₄ Inside Seat Depth 19 ¹ / ₂ 11 yds. COL 220 sq. ft. 133 lbs. TB 133, add \$528 List	2586	3210	3360	3626	3892	4146	4411	4654	4920	6132	7022	7888
3203-LA 	Mid-Back Sofa, Left End Arm (as seated) W 91 ³ / ₄ D 29 ¹ / ₂ H 30 ¹ / ₂ 12 ¹ / ₄ yds. COL 245 sq. ft. 148 lbs. TB 133, add \$588 List	2753	3448	3615	3911	4207	4490	4786	5056	5352	6702	7693	8657
3203-RA 	Mid-Back Sofa, Right End Arm (as seated) W 91 ³ / ₄ D 29 ¹ / ₂ H 30 ¹ / ₂ 12 ¹ / ₄ yds. COL 245 sq. ft. 148 lbs. TB 133, add \$588 List	2753	3448	3615	3911	4207	4490	4786	5056	5352	6702	7693	8657
3203-LR 	Mid-Back Sofa, Left & Right Arm W 93 ¹ / ₄ D 29 ¹ / ₂ H 30 ¹ / ₂ 13 ¹ / ₂ yds. COL 270 sq. ft. 163 lbs. TB 133, add \$648 List	2919	3685	3869	4195	4521	4833	5159	5457	5783	7271	8363	9426
3201-IAM 	Mid-Back Intermediate Arm (per arm) 1/2 yd. COL 10 sq. ft. TB 133, add \$24 List	113	142	149	161	173	184	196	207	220	275	315	354

OPTIONS (XXXX - REFERS TO CHAIR MODEL NUMBER)

MODEL	DESCRIPTION	LIST
XXXX-NS02C	Non-Skid Glides (2 rear and 3 front legs)	25
XXXX-MB05	Moisture Barrier, Seat Only (per sofa)	215
XXXX-PF04	Leg Premium Finish (2 rear and 2-3 front legs)	135
XXXX-PB1-S	Power Band 1 (one power, two USB), Silver	413
XXXX-PB1-W	Power Band 1 (one power, two USB), White	413
XXXX-PB2-S	Power Band 2 (dual power), Silver	322
XXXX-PB2-W	Power Band 2 (dual power), White	322
XXXX-PB3-S	Power Band 3 (dual power, two USB), Silver	429
XXXX-PB3-W	Power Band 3 (dual power, two USB), White	429

NOTES:

- Shelf and privacy panels ordered separately. Please specify immediately following applicable seating unit.
- 40" high shelf can only be specified together with privacy panel and headrest.
- For modular arrangements, a layout drawing or sketch must accompany each order.

SPECIFY:

1. Model number
2. Wood species, as applicable
3. Wood finish, as applicable
4. Shelf post finish, as applicable
5. Upholstery selection, as applicable

ORDERING EXAMPLE:

- #3203-RA**
Mid-Back Sofa, Right Arm
- #MS3-PF02**
Sofa Shelf
Premium Post Finish

INFINIUM MODULAR

designed by michael bemis

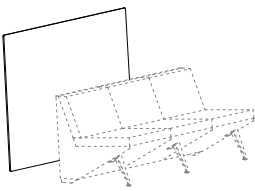
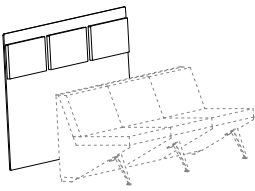
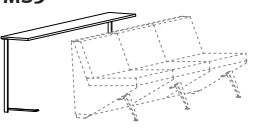
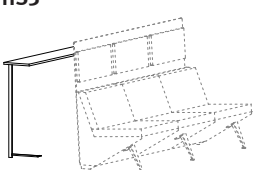

SIN #711-16

MODEL NUMBER	PRODUCT SPECIFICATIONS	PRIVACY PANEL MATERIAL	FABRIC GRADES							LEATHER GRADES					
			COL	1	2	3	4	5	6	7	8	L1	L2	L3	
PR3U (UPHOLSTERED) PR3V (VENEER) PR3L (LAMINATE) PR3W (WHITEBOARD)	Sofa Privacy Panel W 89 ¹ / ₄ H 48 49 lbs. 8 ¹ / ₄ yds. COL 165 sq. ft. TB 133, add \$396 List	upholstered	867	1335	1448	1647	1846	2037	2236	2418	2617	3527	4194	4844	
		veneer or laminate	2004												
		whiteboard	2004												
	Sofa Privacy Panel with Headrest W 89 ¹ / ₄ H 48 49 lbs.	upholstered	1050	1603	1736	1972	2207	2433	2668	2883	3118	4193	4982	5750	
		veneer or laminate	2189	2275	2295	2331	2367	2402	2438	2471	2508	2673	2794	2912	
		whiteboard	2189	2275	2295	2331	2367	2402	2438	2471	2508	2673	2794	2912	
	Upholstered Panel & Headrest: 9 ³ / ₄ yds. COL 195 sq. ft. TB 133, add \$468 List *refer to page 26 for two-tone requirements Non-Upholstered Panel & Headrest: 1 ¹ / ₂ yds. COL 30 sq. ft. TB 133, add \$72 List														
MS3	Sofa Shelf, 30" High W 88 ¹ / ₂ D 12 H 30 55 lbs. Available in Veneer or Laminate		754												
															
HS3	Sofa Shelf, 40" Height Only available together with privacy panel and headrest W 88 ¹ / ₂ D 12 H 40 60 lbs. Available in Veneer or Laminate		763												
															

OPTIONS

MODEL	DESCRIPTION	LIST
XXXX-PF02	Shelf Post Premium Finish	80

INFINIUM MODULAR

designed by michael bemis



SIN #711-16

NOTES:

- Available individually or in modular combinations.
- For modular arrangements, a layout drawing or sketch must accompany each order.**
- Refer to pages 24-26 for two-tone upholstery examples and yardage requirements.





SPECIFY:

- Model number
- Leg finish
- Upholstery selection
- Options, as applicable

ORDERING EXAMPLE:

#3206-MB02-PB3-S

High Back Lounge, Armless
Moisture Barrier
Power Band 1 Unit, Silver

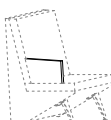
MODEL NUMBER	PRODUCT SPECIFICATIONS	FABRIC GRADES							LEATHER GRADES				
		COM	1	2	COL 3	4	5	6	7	8	L1	L2	L3
3206 	High Back Lounge Chair, Armless W 30 D 29 ¹ / ₂ H 40 ¹ / ₂ Seat Height 17 ¹ / ₂ Inside Seat Width 30 ¹ / ₂ Inside Seat Depth 19 ¹ / ₂ 5 yds. COL 100 sq. ft. 55 lbs. TB 133, add \$240 List	1498	1782	1850	1971	2092	2207	2328	2438	2559	3110	3514	3908
3206-LA 	High Back Lounge, Left End Arm (as seated) W 31 ¹ / ₂ D 29 ¹ / ₂ H 40 ¹ / ₂ 6 ¹ / ₄ yds. COL 125 sq. ft. 70 lbs. TB 133, add \$300 List	1665	2020	2105	2256	2407	2551	2702	2840	2991	3680	4185	4678
3206-RA 	High Back Lounge, Right End Arm (as seated) W 31 ¹ / ₂ D 29 ¹ / ₂ H 40 ¹ / ₂ 6 ¹ / ₄ yds. COL 125 sq. ft. 70 lbs. TB 133, add \$300 List	1665	2020	2105	2256	2407	2551	2702	2840	2991	3680	4185	4678
3206-LR 	High Back Lounge, Left & Right Arm W 33 D 29 ¹ / ₂ H 40 ¹ / ₂ 7 ¹ / ₂ yds. COL 150 sq. ft. 85 lbs. TB 133, add \$360 List	1833	2259	2361	2542	2723	2897	3078	3243	3424	4251	4857	5448
3206-IAH 	High Back Intermediate Arm (per arm) 1 ¹ / ₂ yd. COL 10 sq. ft. TB 133, add \$24 List	113	142	149	161	173	184	196	207	220	275	315	354

OPTIONS (XXXX - REFERS TO CHAIR MODEL NUMBER)

MODEL	DESCRIPTION	LIST
XXXX-NS02B	Non-Skid Glides (2 rear and 2 front legs)	20
XXXX-MB02	Moisture Barrier, Seat Only (per lounge chair)	95
XXXX-PF04	Leg Premium Finish (2 rear and 2-3 front legs)	135
XXXX-PB1-S	Power Band 1 (one power, two USB), Silver	413
XXXX-PB1-W	Power Band 1 (one power, two USB), White	413
XXXX-PB2-S	Power Band 2 (dual power), Silver	322
XXXX-PB2-W	Power Band 2 (dual power), White	322
XXXX-PB3-S	Power Band 3 (dual power, two USB), Silver	429
XXXX-PB3-W	Power Band 3 (dual power, two USB), White	429

NOTES:

- Shelf and privacy panels ordered separately. Please specify immediately following applicable seating unit.
- For modular arrangements, a layout drawing or sketch must accompany each order.

SPECIFY:

1. Model number
2. Wood species, as applicable
3. Wood finish, as applicable
4. Shelf post finish, as applicable
5. Upholstery selection, as applicable

ORDERING EXAMPLE:

#3206-PB3-W
 High Back Lounge, Armless
 Power Band 3 Unit, White

PR1V
 Lounge Privacy Panel, Veneer

**INFINIUM
 MODULAR**

designed by michael bemis

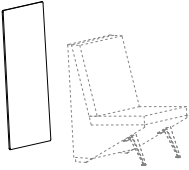
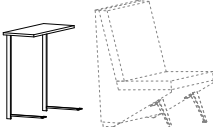
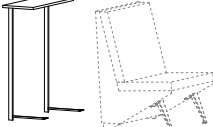

SIN #711-16

MODEL NUMBER	PRODUCT SPECIFICATIONS	PRIVACY PANEL MATERIAL	FABRIC GRADES								LEATHER GRADES				
			COL	1	2	3	4	5	6	7	8	L1	L2	L3	
PR1U (UPHOLSTERED) PR1V (VENEER) PR1L (LAMINATE) PR1W (WHITEBOARD) 	Lounge Chair Privacy Panel W 29 ¹ / ₄ H 48 16 lbs. 2 ³ / ₄ yds. COL 55 sq. ft. TB 133, add \$127 List	upholstered	557	713	751	817	884	947	1014	1074	1141	1444	1666	1883	
		veneer or laminate	1008												
		whiteboard	1008												
MS1 	Lounge Chair Shelf, 30" High W 28 ¹ / ₂ D 12 H 30 18 lbs. Available in Veneer or Laminate		571												
HS1 	Lounge Chair Shelf, 40" High W 28 ¹ / ₂ D 12 H 40 21 lbs. Available in Veneer or Laminate		580												

OPTIONS

MODEL	DESCRIPTION	LIST
XXXX-PF02	Shelf Post Premium Finish	80

INFINIUM MODULAR

designed by michael bemis



SIN #711-16

NOTES:



- Available individually or in modular combinations.
- **For modular arrangements, a layout drawing or sketch must accompany each order.**
- Refer to pages 24-26 for two-tone upholstery examples and yardage requirements.

SPECIFY:

1. Model number
2. Leg finish
3. Upholstery selection
4. Options, as applicable

ORDERING EXAMPLE:

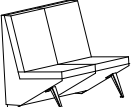
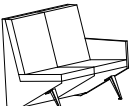
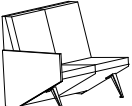
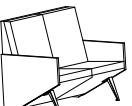
#3207-PF04
High Back Love Seat, Armless
Premium Leg Finish

MODEL NUMBER	PRODUCT SPECIFICATIONS	FABRIC GRADES							LEATHER GRADES				
		COM	1	2	COL			8	L1	L2	L3		
3207 	High Back Love Seat, Armless W 60 D 29 ¹ / ₂ H 40 ¹ / ₂ Seat Height 17 ¹ / ₂ Inside Seat Width 60 Inside Seat Depth 19 ¹ / ₂ 8 ³ / ₄ yds. COL 175 sq. ft. 107 lbs. TB 133, add \$420 List	2077	2574	2693	2904	3116	3318	3529	3722	3933	4898	5605	6295
3207-LA 	High Back Love Seat, Left End Arm (as seated) W 61 ¹ / ₂ D 29 ¹ / ₂ H 40 ¹ / ₂ 10 yds. COL 200 sq. ft. 122 lbs. TB 133, add \$480 List	2244	2811	2948	3189	3431	3662	3903	4124	4365	5468	6276	7064
3207-RA 	High Back Love Seat, Right End Arm (as seated) W 61 ¹ / ₂ D 29 ¹ / ₂ H 40 ¹ / ₂ 10 yds. COL 200 sq. ft. 122 lbs. TB 133, add \$480 List	2244	2811	2948	3189	3431	3662	3903	4124	4365	5468	6276	7064
3207-LR 	High Back Love Seat, Left & Right Arm W 63 D 29 ¹ / ₂ H 40 ¹ / ₂ 11 ¹ / ₄ yds. COL 225 sq. ft. 137 lbs. TB 133, add \$540 List	2411	3049	3203	3475	3746	4006	4278	4526	4798	6038	6947	7833
3206-IAH 	High Back Intermediate Arm (per arm) 1/2 yd. COL 10 sq. ft. TB 133, add \$24 List	113	142	149	161	173	184	196	207	220	275	315	354

OPTIONS (XXXX - REFERS TO CHAIR MODEL NUMBER)

MODEL	DESCRIPTION	LIST
XXXX-NS02B	Non-Skid Glides (2 rear and 2 front legs)	20
XXXX-MB03	Moisture Barrier, Seat Only (per love seat)	145
XXXX-PF04	Leg Premium Finish (2 rear and 2-3 front legs)	135
XXXX-PB1-S	Power Band 1 (one power, two USB), Silver	413
XXXX-PB1-W	Power Band 1 (one power, two USB), White	413
XXXX-PB2-S	Power Band 2 (dual power), Silver	322
XXXX-PB2-W	Power Band 2 (dual power), White	322
XXXX-PB3-S	Power Band 3 (dual power, two USB), Silver	429
XXXX-PB3-W	Power Band 3 (dual power, two USB), White	429

NOTES:

- Shelf and privacy panels ordered separately. Please specify immediately following applicable seating unit.
- For modular arrangements, a layout drawing or sketch must accompany each order.

SPECIFY:

1. Model number
2. Wood species, as applicable
3. Wood finish, as applicable
4. Shelf post finish, as applicable
5. Upholstery selection, as applicable

ORDERING EXAMPLE:

#3207-PF04
High Back Love Seat, Armless
Premium Leg Finish

#HS2-PF02
Love Seat Shelf, 42" Height
Premium Post Finish

INFINIUM MODULAR

designed by michael bemis

SIN #711-16

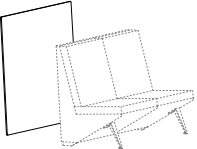
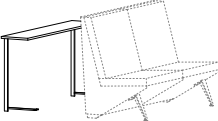
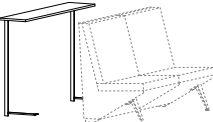
MODEL NUMBER	PRODUCT SPECIFICATIONS	PRIVACY PANEL MATERIAL	FABRIC GRADES								LEATHER GRADES				
			COL	1	2	3	4	5	6	7	8	L1	L2	L3	
PR2U (UPHOLSTERED) PR2V (VENEER) PR2L (LAMINATE) PR2W (WHITEBOARD) 	Love Seat Privacy Panel W 59 ¹ / ₄ H 48 32 lbs. 5 ¹ / ₂ yds. COL 110 sq. ft. TB 133, add \$253 List	upholstered	679	991	1066	1199	1332	1459	1592	1713	1846	2452	2897	3330	
		veneer or laminate	1386												
		whiteboard	1386												
MS2 	Love Seat Shelf, 30" Height W 58 ¹ / ₂ D 12 H 30 36 lbs. Available in Veneer or Laminate		685												
HS2 	Love Seat Shelf, 40" Height W 58 ¹ / ₂ D 12 H 40 40 lbs. Available in Veneer or Laminate		693												

OPTIONS

MODEL	DESCRIPTION	LIST
XXXX-PF02	Shelf Post Premium Finish	80

INFINIUM MODULAR

designed by michael bemis

NOTES:

- Available individually or in modular combinations.
- For modular arrangements, a layout drawing or sketch must accompany each order.**
- Refer to pages 24-26 for two-tone upholstery examples and yardage requirements.

SPECIFY:

- Model number
- Leg finish
- Upholstery selection
- Options, as applicable

ORDERING EXAMPLE:

#3208-LR-MB05
High Back Lounge, Left and Right Arm
Moisture Barrier

SIN #711-16

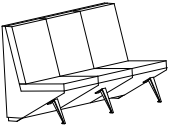
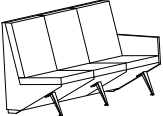
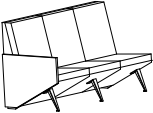
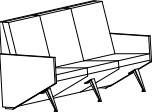
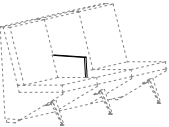
MODEL NUMBER	PRODUCT SPECIFICATIONS	FABRIC GRADES							LEATHER GRADES			
		COM	1	2	COL 3	4	5	6	7	8	L1	L2
 <p>3208 High Back Sofa, Armless W 90³/₄ D 29¹/₂ H 40¹/₂ Seat Height 17¹/₂ Inside Seat Width 90¹/₄ Inside Seat Depth 19¹/₂ 12¹/₂ yds. COL 250 sq. ft. 158 lbs. TB 133, add \$600 List</p>	2772	3481	3652	3954	4256	4544	4846	5122	5424	6802	7812	8797
 <p>3208-LA High Back Sofa, Left End Arm (as seated) W 91³/₄ D 29¹/₂ H 40¹/₂ 13³/₄ yds. COL 275 sq. ft. 173 lbs. TB 133, add \$660 List</p>	2939	3719	3907	4239	4571	4889	5221	5524	5856	7372	8483	9566
 <p>3208-RA High Back Sofa, Right End Arm (as seated) W 91³/₄ D 29¹/₂ H 40¹/₂ 13³/₄ yds. COL 275 sq. ft. 173 lbs. TB 133, add \$660 List</p>	2939	3719	3907	4239	4571	4889	5221	5524	5856	7372	8483	9566
 <p>3208-LR High Back Sofa, Left & Right Arm W 93¹/₄ D 29¹/₂ H 40¹/₂ 15 yds. COL 300 sq. ft. 188 lbs. TB 133, add \$720 List</p>	3106	3957	4162	4524	4886	5233	5595	5926	6288	7942	9154	10336
 <p>3206-IAH High Back Intermediate Arm (per arm) 1/2 yd. COL 10 sq. ft. TB 133, add \$24 List</p>	113	142	149	161	173	184	196	207	220	275	315	354

OPTIONS (XXXX - REFERS TO CHAIR MODEL NUMBER)

MODEL	DESCRIPTION	LIST
XXXX-NS02C	Non-Skid Glides (2 rear and 3 front legs)	25
XXXX-MB05	Moisture Barrier, Seat Only (per sofa)	215
XXXX-PF04	Leg Premium Finish (2 rear and 2-3 front legs)	135
XXXX-PB1-S	Power Band 1 (one power, two USB), Silver	413
XXXX-PB1-W	Power Band 1 (one power, two USB), White	413
XXXX-PB2-S	Power Band 2 (dual power), Silver	322
XXXX-PB2-W	Power Band 2 (dual power), White	322
XXXX-PB3-S	Power Band 3 (dual power, two USB), Silver	429
XXXX-PB3-W	Power Band 3 (dual power, two USB), White	429

NOTES:

- Shelf and privacy panels ordered separately. Please specify immediately following applicable seating unit.
- For modular arrangements, a layout drawing or sketch must accompany each order.

SPECIFY:

1. Model number
2. Wood species, as applicable
3. Wood finish, as applicable
4. Shelf post finish, as applicable
5. Upholstery selection, as applicable

ORDERING EXAMPLE:

#3208-LR
High Back Sofa, Left and Right Arm

#PR3W
Sofa Privacy Panel, Whiteboard

INFINIUM MODULAR

designed by michael bemis

SIN #711-16

MODEL NUMBER	PRODUCT SPECIFICATIONS	PRIVACY PANEL MATERIAL	FABRIC GRADES									LEATHER GRADES			
			COL	1	2	3	4	5	6	7	8	L1	L2	L3	
PR3U (UPHOLSTERED) PR3V (VENEER) PR3L (LAMINATE) PR3W (WHITEBOARD)	Sofa Privacy Panel W 89 ¹ / ₄ H 48 49 lbs. 8 ¹ / ₄ yds. COL 165 sq. ft. TB 133, add \$380 List	upholstered	867	1335	1448	1647	1846	2037	2236	2418	2617	3527	4194	4844	
		veneer or laminate	2004												
		whiteboard	2004												
MS3	Sofa Shelf, 30" High W 88 ¹ / ₂ D 12 H 30 55 lbs. Available in Veneer or Laminate		754												
HS3	Sofa Shelf, 40" High W 88 ¹ / ₂ D 12 H 42 60 lbs. Available in Veneer or Laminate		763												

OPTIONS

MODEL	DESCRIPTION	LIST
XXXX-PF02	Shelf Post Premium Finish	80

INFINIUM MODULAR

designed by michael bemis



NOTES:

- Available in Maple, Walnut and White Oak veneer as well as laminate selections.
- Straight and tapered benches available individually, or group together to create larger seating arrangements.
- Benches can also be used in modular configurations for ancillary seating (free-standing applications only, benches do not gang with lounge units or tables).
- Refer to page 26 for two-tone upholstery examples and yardage requirements.

SPECIFY:



1. Model number
2. Wood species, as applicable
3. Wood finish, as applicable
4. Leg finish
5. Upholstery selection
6. Options, as applicable

ORDERING EXAMPLE:

#3220-18-U-PF04

Straight Bench, Upholstered
Seat and Body
Premium Leg Finish

SIN #711-16

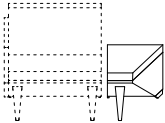
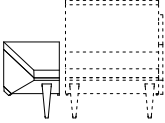
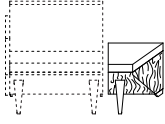
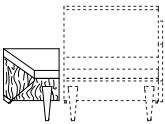
MODEL NUMBER	PRODUCT SPECIFICATIONS	FABRIC GRADES								LEATHER GRADES						
		COM	1	2	COL			4	5	6	7	8	L1	L2	L3	
3220-18-U 	Straight Bench with Upholstered Seat and Upholstered Body W 18 D 27 ¹ / ₄ H 17 ¹ / ₂ 2 yds. 40 lbs. COL 40 Sq. Ft. TB 133, add \$96 List	991	1105	1132	1180	1229	1275	1323	1367	1416	1636	1798	1955			
3220-18-V 	Straight Bench with Upholstered Seat and Veneer or Laminate Body W 18 D 27 ¹ / ₄ H 17 ¹ / ₂ 3/4 yd. 40 lbs. COL 15 Sq. Ft. TB 133, add \$36 List	1153	1196	1206	1224	1242	1260	1278	1294	1313	1395	1456	1515			
3220-20L-U 	Angled Bench, Tapered Left (as seated) with Upholstered Seat and Body W 18 D 27 ¹ / ₄ H 17 ¹ / ₂ 2 yds. 32 lbs. COL 40 Sq. Ft. TB 133, add \$96 List	873	987	1014	1062	1111	1157	1205	1249	1298	1518	1680	1837			
3220-20R-U 	Angled Bench, Tapered Right (as seated) with Upholstered Seat and Body W 18 D 27 ¹ / ₄ H 17 ¹ / ₂ 2 yds. 32 lbs. COL 40 Sq. Ft. TB 133, add \$96 List	873	987	1014	1062	1111	1157	1205	1249	1298	1518	1680	1837			
3220-20L-V 	Angled Bench, Tapered Left (as seated) with Upholstered Seat and Veneer or Laminate Body W 18 D 27 ¹ / ₄ H 17 ¹ / ₂ 3/4 yds. 32 lbs. COL 15 Sq. Ft. TB 133, add \$36 List	1050	1093	1103	1121	1139	1157	1175	1191	1210	1292	1353	1412			
3220-20R-V 	Angled Bench, Tapered Right (as seated) with Upholstered Seat and Veneer or Laminate Body W 18 D 27 ¹ / ₄ H 17 ¹ / ₂ 3/4 yds. 32 lbs. COL 15 Sq. Ft. TB 133, add \$36 List	1050	1093	1103	1121	1139	1157	1175	1191	1210	1292	1353	1412			

OPTIONS (XXXX - REFERS TO BENCH MODEL NUMBER)

MODEL	DESCRIPTION	LIST
XXXX-NS02A	Non-Skid Glides (2 rear and 1 front leg)	10
XXXX-NS02B	Non-Skid Glides (2 rear and 2 front legs)	20
XXXX-MB01	Moisture Barrier, Seat Only	50
XXXX-PF02	Leg Premium Finish (2 rear and 1 front leg)	80
XXXX-PF04	Leg Premium Finish (2 rear and 2 front legs)	135

NOTES:

- Available in Maple, Walnut and White Oak veneer as well as laminate selections.
- Refer to page 26 for two-tone upholstery examples and yardage requirements.

SPECIFY:

1. Model number
2. Wood species, as applicable
3. Wood finish, as applicable
4. Leg finish
5. Upholstery selection
6. Options, as applicable

ORDERING EXAMPLE:

#3220-3636-U-NS02B



36" Square Bench
Non-Skid Glides

**INFINIUM
MODULAR**

designed by michael bemis

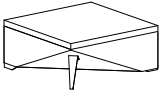

SIN #711-16

MODEL NUMBER	PRODUCT SPECIFICATIONS	FABRIC GRADES										LEATHER GRADES		
		COM	1	2	COL			6	7	8	L1	L2	L3	
3220-3636-U 	36" Square Bench with Upholstered Seat and Body W 36 D 36 H 17 4 ¹ / ₂ yds. 83 lbs. COL 90 Sq. Ft. TB 133, add \$216 List	1275	1531	1592	1701	1809	1913	2022	2121	2230	2726	3090	3444	
		1493	1593	1617	1659	1701	1742	1784	1822	1865	2058	2199	2337	
3220-3636-V 	36" Square Bench with Upholstered Seat and Veneer or Laminate Body W 36 D 36 H 17 1 ³ / ₄ yds. 83 lbs. COL 35 Sq. Ft. TB 133, add \$84 List	1493	1593	1617	1659	1701	1742	1784	1822	1865	2058	2199	2337	
		1493	1593	1617	1659	1701	1742	1784	1822	1865	2058	2199	2337	

OPTIONS (XXXX - REFERS TO BENCH MODEL NUMBER)

MODEL	DESCRIPTION	LIST
XXXX-NS02B	Non-Skid Glides (2 rear and 2 front legs)	20
XXXX-MB01	Moisture Barrier, Seat Only	45
XXXX-PF04	Leg Premium Finish (2 rear and 2 front legs)	135

INFINIUM MODULAR

designed by michael bemis



SIN #711-11

NOTES:

- Available in veneer, laminate or Corian.
- Veneer options include Maple, Walnut and White Oak.
- For Corian top, add “-CO” next to model number and specify color. Corian top is affixed to table top surface increasing overall table height by 1/2". Please note that a 1/8" reveal will be present.

SPECIFY:

1. Model number
2. Wood species
3. Wood finish
4. Leg finish
5. Options, as applicable

ORDERING EXAMPLE:

#3230-20R-CO-PB1-W

20-Degree End Table, Right
Corian Top
Power Band 1 Unit, White

MODEL NUMBER	PRODUCT SPECIFICATIONS	TABLE TOP FINISH	
		VENEER OR LAMINATE	CORIAN (-CO)
3230-18 	18" Straight Table, Free-Standing W 18 D 27 ¹ / ₄ H 16 40 lbs.	1288	1919
3230-20L 	20-Degree Angled End Table, Free-Standing, Tapered Left (as seated) W 18 D 27 ¹ / ₄ H 16 32 lbs.	1208	1662
3230-20R 	20-Degree Angled End Table, Free-Standing, Tapered Right (as seated) W 18 D 27 ¹ / ₄ H 16 32 lbs.	1208	1662
3230-3636 	36" Square Occasional Table, Free-Standing (has 2 rear and 2 front legs) W 36 D 36 H 16 83 lbs.	1911	3519

OPTIONS (XXXX - REFERS TO TABLE MODEL NUMBER)

MODEL	DESCRIPTION	LIST
XXXX-NS02A	Non-Skid Glides (2 rear and 1 front leg)	10
XXXX-NS02B	Non-Skid Glides (2 rear and 2 front legs)	20
XXXX-PF02	Leg Premium Finish (2 rear and 1 front leg)	80
XXXX-PF04	Leg Premium Finish (2 rear and 2 front legs)	135
XXXX-PB1-S	Power Band 1 (one power, two USB), Silver	413
XXXX-PB1-W	Power Band 1 (one power, two USB), White	413
XXXX-PB2-S	Power Band 2 (dual power), Silver	322
XXXX-PB2-W	Power Band 2 (dual power), White	322
XXXX-PB3-S	Power Band 3 (dual power, two USB), Silver	429
XXXX-PB3-W	Power Band 3 (dual power, two USB), White	429

NOTES:

- Each unit comes with pre-drilled holes to accept linking connectors.
- Available in veneer, laminate or Corian.
- Veneer options include Maple, Walnut and White Oak.
- For Corian top, add “-CO” next to model number and specify color. Corian top is affixed to table top surface increasing over all table height by 1/2". Please note that a 1/8" reveal will be present.
- For modular arrangements, a layout drawing or sketch must accompany each order.

SPECIFY:

1. Model number
2. Wood species, as applicable
3. Wood finish, as applicable
4. Options, as applicable

ORDERING EXAMPLE:

#3240-30-CO-PB2-S



30-Degree Ganging Table
Corian Top
Power Band 2 Unit, Silver

INFINIUM MODULAR

designed by michael bemis

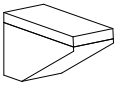
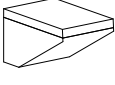

SIN #711-16

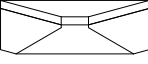
MODEL NUMBER	PRODUCT SPECIFICATIONS	TABLE TOP FINISH	
		VENEER OR LAMINATE	CORIAN (-CO)
3240-12 	12" Straight In-Line Ganging Table W 12 D 27 ¹ / ₄ H 15 ¹ / ₂ 29 lbs.	918	1392
3240-18 	18" Straight In-Line Ganging Table W 18 D 27 ¹ / ₄ H 15 ¹ / ₂ 33 lbs.	1074	1703
3240-30 	30-Degree In-Line Ganging Table W 23 ¹ / ₂ D 26 ¹ / ₂ H 15 ¹ / ₂ 31 lbs.	1178	1674
3240-45 	45-Degree In-Line Ganging Table W 30 D 25 ¹ / ₂ H 15 ¹ / ₂ 39 lbs.	1290	1832
3240-90 	90-Degree In-Line Ganging Corner Table W 47 ¹ / ₂ D 19 ¹ / ₂ H 15 ¹ / ₂ 46 lbs.	1481	2070

OPTIONS (XXXX - REFERS TO TABLE MODEL NUMBER)

MODEL	DESCRIPTION	LIST
XXXX-PB1-S	Power Band 1 (one power, two USB), Silver	413
XXXX-PB1-W	Power Band 1 (one power, two USB), White	413
XXXX-PB2-S	Power Band 2 (dual power), Silver	322
XXXX-PB2-W	Power Band 2 (dual power), White	322
XXXX-PB3-S	Power Band 3 (dual power, two USB), Silver	429
XXXX-PB3-W	Power Band 3 (dual power, two USB), White	429

INFINIUM MODULAR

designed by michael bemis

NOTES:

- Each unit comes with pre-drilled holes to accept linking connectors.
- Available in veneer, laminate or Corian.
- Veneer options include Maple, Walnut and White Oak.
- For Corian top, add “-CO” next to model number and specify color. Corian top is affixed to table top surface increasing over all table height by 1/2". Please note that a 1/8" reveal will be present.
- **For modular arrangements, a layout drawing or sketch must accompany each order.**

SPECIFY:

1. Model number
2. Wood species, as applicable
3. Wood finish, as applicable
4. Options, as applicable

ORDERING EXAMPLE:

#3250-18R-PF02

18" Straight Ganging End Table, Right
Premium Leg Finish

SIN #711-11

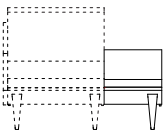
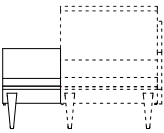
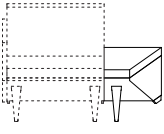
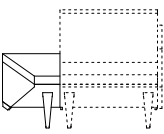
MODEL NUMBER	PRODUCT SPECIFICATIONS	TABLE TOP FINISH	
		VENEER OR LAMINATE	CORIAN (-CO)
3250-18L 	18" Straight Ganging End Table, Left (as seated) W 18 D 27 ¹ / ₄ H 17 38 lbs.	1188	1818
3250-18R 	18" Straight Ganging End Table, Right (as seated) W 18 D 27 ¹ / ₄ H 17 38 lbs.	1188	1818
3250-20L 	20-Degree Angled Ganging End Table, Tapered Left (as seated) W 18 D 27 ¹ / ₄ H 17 32 lbs.	1169	1624
3250-20R 	20-Degree Angled Ganging End Table, Tapered Right (as seated) W 18 D 27 ¹ / ₄ H 17 32 lbs.	1169	1624

OPTIONS (XXXX - REFERS TO TABLE MODEL NUMBER)

MODEL	DESCRIPTION	LIST
XXXX-NS02A	Non-Skid Glides (2 rear and 1 front leg)	10
XXXX-PF02	Leg Premium Finish (2 rear and 1 front leg)	80
XXXX-PB1-S	Power Band 1 (one power, two USB), Silver	413
XXXX-PB1-W	Power Band 1 (one power, two USB), White	413
XXXX-PB2-S	Power Band 2 (dual power), Silver	322
XXXX-PB2-W	Power Band 2 (dual power), White	322
XXXX-PB3-S	Power Band 3 (dual power, two USB), Silver	429
XXXX-PB3-W	Power Band 3 (dual power, two USB), White	429

INFINIUM MODULAR

designed by michael bemis

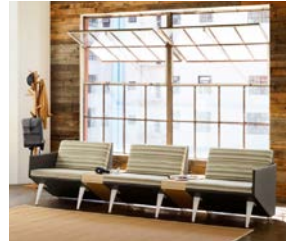

SIN #711-16

CONFIGURATION AND ORDERING EXAMPLES

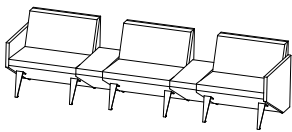

Qty	Model #	Description	COM List
1	3201-RA	Mid-Back Lounge, Right End Arm (as seated)	1,549
1	3201	Mid-Back Lounge, Armless	1,382
1	3201-LA	Mid-Back Lounge, Left End Arm (as seated)	1,549
<u>2</u>	<u>3240-12</u>	<u>12" Straight In-Line Tables, Veneer (\$918 each)</u>	<u>1,836</u>
5			6,316

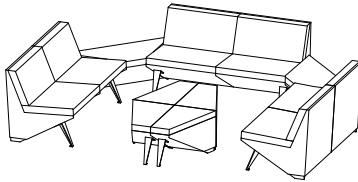

Qty	Model #	Description	COM List
3	3202	Mid-Back Love Seats (\$1,903 each)	5,709
2	3240-90	90-Degree Corner Tables, Veneer (\$1,481 each)	2,962
2	3220-20R-U	Angled Bench Tapered Right (\$873 each)	1,746
<u>2</u>	<u>3220-20L-U</u>	<u>Angled Bench Tapered Left (\$873 each)</u>	<u>1,746</u>
9			12,163

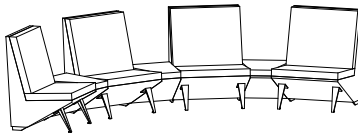

Qty	Model #	Description	COM List
4	3206	High Back Lounge (\$1,498 each)	5,992
<u>3</u>	<u>3240-30</u>	<u>30-Degree In-Line Table (\$1,178 each)</u>	<u>3,534</u>
7			9,526

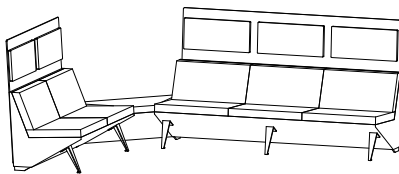

Qty	Model #	Description	COM List
1	3202	Mid-Back Love Seat	1,903
1	PR2V-HR2	Love Seat Privacy Panel with Headrest, Veneer	1,510
1	3203	Mid-Back Sofa	2,583
1	PR3V-HR3	Sofa Privacy Panel with Headrest, Veneer	2,189
<u>1</u>	<u>3240-90</u>	<u>90-Degree Corner Table</u>	<u>1,481</u>
5			9,666

INFINIUM MODULAR

designed by michael bemis



UPHOLSTERY COMBINATIONS:

For fabric, vinyl or leather upholstery combinations, refer to the pricing below:

- When combining **two** COM/COV/COL fabrics, or fabrics with the same grade, add the following (per unit):
 - › \$65 List for lounge chairs, benches and privacy panels
 - › \$105 List for love seats
 - › \$130 List for sofas
- When combining **three or more** COM/COV/COL fabrics, or fabrics with the same grade, add the following (per unit):
 - › \$75 List for lounge chairs, benches and privacy panels
 - › \$115 List for love seats
 - › \$140 List for sofas
- When combining different grades of fabric, price will be based on the highest grade specified.
- Two-tone upholstery examples and yardage requirements for the most common combinations are listed below. Additional combinations available, please contact Customer Service for yardage requirements and pricing.
- Note: Yardage amounts are based on fabric which is plain (i.e. non-directional) and a full 54" wide.
- **Appropriate upholstery code must be included on order.**

SIN #711-16



Code IF1
Model 3201
COM Requirement
Seat Cushion Only = 1¹/₄ yds.
Balance of Chair = 3¹/₂ yds.



Code IF2
Model 3201-LA
3201-RA
COM Requirement
Seat Cushion Only = 1 yd.
Balance of Chair = 4 yds.

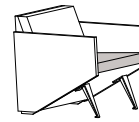

Code IF3
Model 3201-LR
COM Requirement
Seat Cushion Only = 1 yd.
Balance of Chair = 5 yds.



Code IF4
Model 3201
COM Requirement
Back and Seat Cushion = 1³/₄ yds.
Balance of Chair = 2³/₄ yds.



Code IF5
Model 3201-LA
3201-RA
COM Requirement
Back and Seat Cushion = 1³/₄ yds.
Balance of Chair = 3¹/₂ yds.

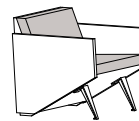

Code IF6
Model 3201-LR
COM Requirement
Back and Seat Cushion = 1³/₄ yds.
Balance of Chair = 4¹/₂ yds.



Code IF7
Model 3201
COM Requirement
Back & Seat Cushion/Underside = 2³/₄ yds.
Balance of Chair = 1¹/₂ yds.



Code IF8
Model 3201-LA
3201-RA
COM Requirement
Back & Seat Cushion/Underside = 2³/₄ yds.
Balance of Chair = 2¹/₂ yds.

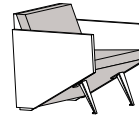

Code IF9
Model 3201-LR
COM Requirement
Back & Seat Cushion/Underside = 2³/₄ yds.
Balance of Chair = 3¹/₂ yds.

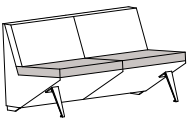

Code IF10
Model 3202
COM Requirement
Seat Cushion Only = 2¹/₄ yds.
Balance of Chair = 6¹/₄ yds.

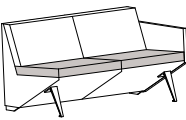

Code IF11
Model 3202-LA
3202-RA
COM Requirement
Seat Cushion Only = 2¹/₄ yds.
Balance of Chair = 6³/₄ yds.

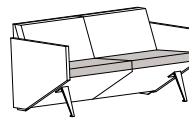

Code IF12
Model 3202-LR
COM Requirement
Seat Cushion Only = 2¹/₄ yds.
Balance of Chair = 7¹/₂ yds.

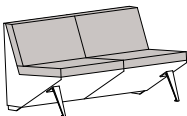

Code IF13
Model 3202
COM Requirement
Back and Seat Cushion = 3¹/₂ yds.
Balance of Love Seat = 4 yds.

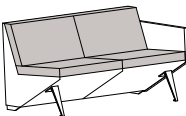

Code IF14
Model 3202-LA
3202-RA
COM Requirement
Back and Seat Cushion = 3¹/₂ yds.
Balance of Love Seat = 5 yds.

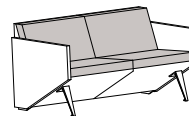

Code IF15
Models 3202-LR
COM Requirement
Back and Seat Cushion = 3¹/₂ yds.
Balance of Love Seat = 6 yds.

UPHOLSTERY COMBINATIONS:

For fabric, vinyl or leather upholstery combinations, refer to the pricing below:

- When combining **two** COM/COV/COL fabrics, or fabrics with the same grade, add the following (per unit):
 - › \$65 List for lounge chairs, benches and privacy panels
 - › \$105 List for love seats
 - › \$130 List for sofas
- When combining **three or more** COM/COV/COL fabrics, or fabrics with the same grade, add the following (per unit):
 - › \$75 List for lounge chairs, benches and privacy panels
 - › \$115 List for love seats
 - › \$140 List for sofas

- When combining different grades of fabric, price will be based on the highest grade specified.
- Two-tone upholstery examples and yardage requirements for the most common combinations are listed below. Additional combinations available, please contact Customer Service for yardage requirements and pricing.
- Note: Yardage amounts are based on fabric which is plain (i.e. non-directional) and a full 54" wide.
- **Appropriate upholstery code must be included on order.**

INFINIUM MODULAR

designed by michael bemis



SIN #711-16

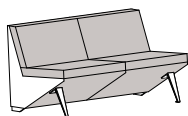

Code IF16
Model COM Requirement
 3202 Back & Seat Cushion/Underside = 5¹/₄ yds.
 Balance of Love Seat = 2¹/₂ yds.

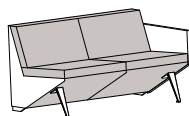

Code IF17
Model COM Requirement
 3202-LA Back & Seat Cushion/Underside = 5¹/₄ yds.
 3202-RA Balance of Love Seat = 3¹/₂ yds.

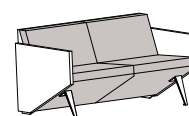

Code IF18
Models COM Requirement
 3202-LR Back & Seat Cushion/Underside = 5¹/₄ yds.
 Balance of Love Seat = 4¹/₂ yds.

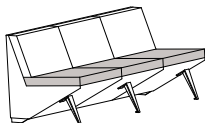

Code IF19
Model COM Requirement
 3203 Seat Cushion Only = 3¹/₄ yds.
 Balance of Sofa = 8¹/₄ yds.

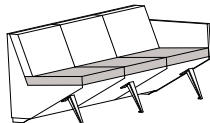

Code IF20
Model COM Requirement
 3203-LA Seat Cushion Only = 3¹/₄ yds.
 3203-RA Balance of Sofa = 9 yds.

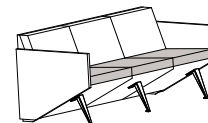

Code IF21
Models COM Requirement
 3203-LR Seat Cushion Only = 3¹/₄ yds.
 Balance of Sofa = 10 yds.

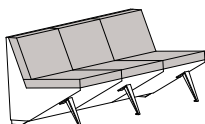

Code IF22
Model COM Requirement
 3203 Back and Seat Cushion = 5 yds.
 Balance of Sofa = 5³/₄ yds.

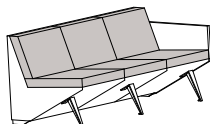

Code IF23
Model COM Requirement
 3203-LA Back and Seat Cushion = 5 yds.
 3203-RA Balance of Sofa = 6³/₄ yds.

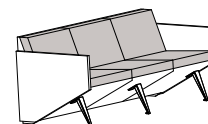

Code IF24
Models COM Requirement
 3203-LR Back and Seat Cushion = 5 yds.
 Balance of Sofa = 7¹/₂ yds.

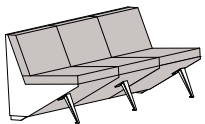

Code IF25
Model COM Requirement
 3203 Back & Seat Cushion/Underside = 5 yds.
 Balance of Sofa = 5³/₄ yds.

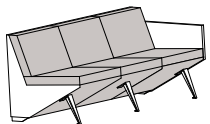

Code IF26
Model COM Requirement
 3203-LA Back & Seat Cushion/Underside = 5 yds.
 3203-RA Balance of Sofa = 6³/₄ yds.

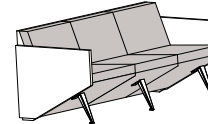

Code IF27
Models COM Requirement
 3203-LR Back & Seat Cushion/Underside = 5 yds.
 Balance of Sofa = 7¹/₂ yds.

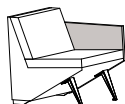

Code IF28
Model COM Requirement
 3201-LA Arm Only = 1¹/₄ yds.
 3201-RA Balance of Chair = 4 yds.

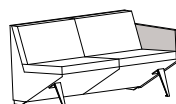

Code IF29
Model COM Requirement
 3202-LA Arm Only = 1¹/₄ yds.
 3202-RA Balance of Love Seat = 7¹/₂ yds.

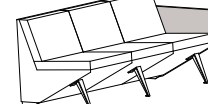

Code IF30
Models COM Requirement
 3203-LA Arm Only = 1¹/₄ yds.
 3203-RA Balance of Sofa = 11 yds.

INFINIUM MODULAR

designed by michael bemis

SIN #711-16

UPHOLSTERY COMBINATIONS:

For fabric, vinyl or leather upholstery combinations, refer to the pricing below:

- When combining **two** COM/COV/COL fabrics, or fabrics with the same grade, add the following (per unit):
 - › \$65 List for lounge chairs, benches and privacy panels
 - › \$105 List for love seats
 - › \$130 List for sofas
- When combining **three or more** COM/COV/COL fabrics, or fabrics with the same grade, add the following (per unit):
 - › \$75 List for lounge chairs, benches and privacy panels
 - › \$115 List for love seats
 - › \$140 List for sofas
- When combining different grades of fabric, price will be based on the highest grade specified.
- Two-tone upholstery examples and yardage requirements for the most common combinations are listed below. Additional combinations available, please contact Customer Service for yardage requirements and pricing.
- Note: Yardage amounts are based on fabric which is plain (i.e. non-directional) and a full 54" wide.
- **Appropriate upholstery code must be included on order.**



Code IF31
Model 3206
COM Requirement
Seat Cushion Only = 1 yd.
Balance of Chair = 4 yds.



Code IF32
Model 3206-LA 3206-RA
COM Requirement
Seat Cushion Only = 1 yd.
Balance of Chair = 4³/₄ yds.

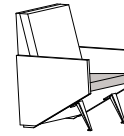

Code IF33
Model 3206-LR
COM Requirement
Seat Cushion Only = 1 yd.
Balance of Chair = 5³/₄ yds.



Code IF34
Model 3206
COM Requirement
Back and Seat Cushion = 2 yds.
Balance of Chair = 2 yds.



Code IF35
Model 3206-LA 3206-RA
COM Requirement
Back and Seat Cushion = 2 yds.
Balance of Chair = 3³/₄ yds.

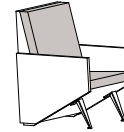

Code IF36
Model 3206-LR
COM Requirement
Back and Seat Cushion = 2 yds.
Balance of Chair = 4³/₂ yds.



Code IF37
Model 3206
COM Requirement
Back & Seat Cushion/Underside = 3 yds.
Balance of Chair = 1³/₄ yds.



Code IF38
Model 3206-LA 3206-RA
COM Requirement
Back & Seat Cushion/Underside = 3 yds.
Balance of Chair = 2³/₄ yds.

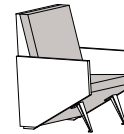

Code IF39
Model 3206-LR
COM Requirement
Back & Seat Cushion/Underside = 3 yds.
Balance of Chair = 3³/₄ yds.



Code IF40
Model 3207
COM Requirement
Seat Cushion Only = 2 yds.
Balance of Love Seat = 7 yds.

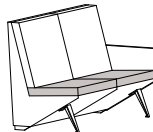

Code IF41
Model 3207-LA 3207-RA
COM Requirement
Seat Cushion Only = 2 yds.
Balance of Love Seat = 7³/₄ yds.

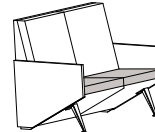

Code IF42
Models 3207-LR
COM Requirement
Seat Cushion Only = 2 yds.
Balance of Love Seat = 8³/₄ yds.

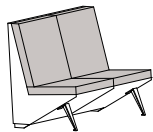

Code IF43
Model 3207
COM Requirement
Back and Seat Cushion = 3¹/₂ yds.
Balance of Love Seat = 5¹/₄ yds.

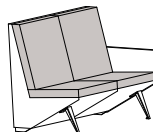

Code IF44
Model 3207-LA 3207-RA
COM Requirement
Back and Seat Cushion = 3¹/₂ yds.
Balance of Love Seat = 6 yds.

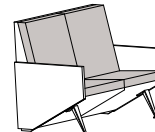

Code IF45
Models 3207-LR
COM Requirement
Back and Seat Cushion = 3¹/₂ yds.
Balance of Love Seat = 6³/₄ yds.

UPHOLSTERY COMBINATIONS:

For fabric, vinyl or leather upholstery combinations, refer to the pricing below:

- When combining **two** COM/COV/COL fabrics, or fabrics with the same grade, add the following (per unit):
 - › \$65 List for lounge chairs, benches and privacy panels
 - › \$105 List for love seats
 - › \$130 List for sofas
- When combining **three or more** COM/COV/COL fabrics, or fabrics with the same grade, add the following (per unit):
 - › \$75 List for lounge chairs, benches and privacy panels
 - › \$115 List for love seats
 - › \$140 List for sofas

- When combining different grades of fabric, price will be based on the highest grade specified.
- Two-tone upholstery examples and yardage requirements for the most common combinations are listed below. Additional combinations available, please contact Customer Service for yardage requirements and pricing.
- Note: Yardage amounts are based on fabric which is plain (i.e. non-directional) and a full 54" wide.
- **Appropriate upholstery code must be included on order.**

INFINIUM MODULAR

designed by michael bemis

SIN #711-16



Code IF46

Model COM Requirement
3207 Back & Seat Cushion/Underside = 5³/₄ yds.
Balance of Love Seat = 3 yds.

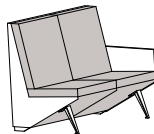

Code IF47

Model COM Requirement
3207-LA Back & Seat Cushion/Underside = 5³/₄ yds.
3207-RA Balance of Love Seat = 4 yds.

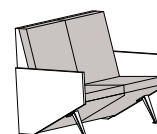

Code IF48

Models COM Requirement
3207-LR Back & Seat Cushion/Underside = 5³/₄ yds.
Balance of Love Seat = 4³/₄ yds.

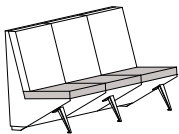

Code IF49

Model COM Requirement
3208 Seat Cushion Only = 3 yds.
Balance of Sofa = 10 yds.

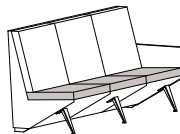

Code IF50

Model COM Requirement
3208-LA Seat Cushion Only = 3 yds.
3208-RA Balance of Sofa = 10³/₄ yds.

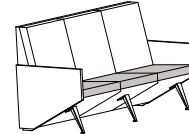

Code IF51

Models COM Requirement
3208-LR Seat Cushion Only = 3 yds.
Balance of Sofa = 11³/₄ yds.

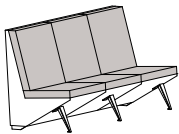

Code IF52

Model COM Requirement
3208 Back and Seat Cushion = 5¹/₂ yds.
Balance of Sofa = 7¹/₂ yds.

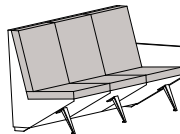

Code IF53

Model COM Requirement
3208-LA Back and Seat Cushion = 5¹/₂ yds.
3208-RA Balance of Sofa = 8¹/₄ yds.

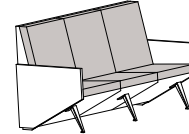

Code IF54

Models COM Requirement
3208-LR Back and Seat Cushion = 5¹/₂ yds.
Balance of Sofa = 9 yds.

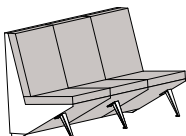

Code IF55

Model COM Requirement
3208 Back & Seat Cushion/Underside = 8¹/₂ yds.
Balance of Sofa = 4¹/₄ yds.

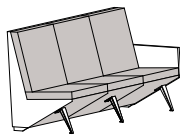

Code IF56

Model COM Requirement
3208-LA Back & Seat Cushion/Underside = 8¹/₂ yds.
3208-RA Balance of Sofa = 5 yds.

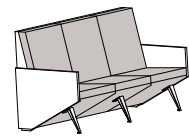

Code IF57

Models COM Requirement
3208-LR Back & Seat Cushion/Underside = 8¹/₂ yds.
Balance of Sofa = 5³/₄ yds.

INFINIUM MODULAR

designed by michael bemis

UPHOLSTERY COMBINATIONS:

For fabric, vinyl or leather upholstery combinations, refer to the pricing below:

- When combining **two** COM/COV/COL fabrics, or fabrics with the same grade, add the following (per unit):
 - › \$65 List for lounge chairs, benches and privacy panels
 - › \$105 List for love seats
 - › \$130 List for sofas
 - When combining **three or more** COM/COV/COL fabrics, or fabrics with the same grade, add the following (per unit):
 - › \$75 List for lounge chairs, benches and privacy panels
 - › \$115 List for love seats
 - › \$140 List for sofas
- When combining different grades of fabric, price will be based on the highest grade specified.
 - Two-tone upholstery examples and yardage requirements for the most common combinations are listed below. Additional combinations available, please contact Customer Service for yardage requirements and pricing.
 - Note: Yardage amounts are based on fabric which is plain (i.e. non-directional) and a full 54" wide.
 - **Appropriate upholstery code must be included on order.**

SIN #711-16



Code IF58
Model COM Requirement
 3206-LA Arm Only = 1¹/₄ yds.
 3206-RA Balance of Chair = 4 yds.

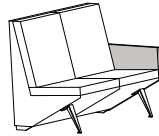

Code IF59
Model COM Requirement
 3207-LA Arm Only = 1¹/₄ yds.
 3207-RA Balance of Love Seat = 7¹/₂ yds.

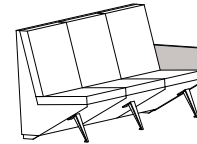

Code IF60
Models COM Requirement
 3208-LA Arm Only = 1¹/₄ yds.
 3208-RA Balance of Sofa = 11 yds.



Code IF61
Model COM Requirement
 3220-18-U Seat Cushion = 1 yd.
 Balance of Bench = 1¹/₂ yds.



Code IF62
Model COM Requirement
 3220-20L-U Seat Cushion = 1 yd.
 3220-20R-U Balance of Bench = 1¹/₂ yds.

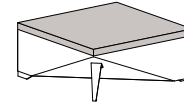

Code IF63
Model COM Requirement
 3220-3636-U Seat Cushion = 1¹/₂ yds.
 Balance of Bench = 3 yds.



Code IF64
Model COM Requirement
 PR1U-HR1 Headrest = 3³/₄ yd.
 Panel = 2³/₄ yds.

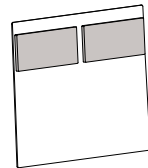

Code IF65
Model COM Requirement
 PR2U-HR2 Headrests = 1¹/₄ yds.
 Panel = 5¹/₂ yds.

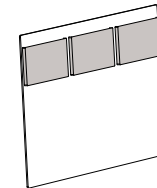

Code IF66
Model COM Requirement
 PR3U-HR3 Headrests = 1¹/₂ yds.
 Panel = 8¹/₄ yds.

NOTES:

- Available in veneer, laminate or Corian.
- Veneer options include Maple, Walnut and White Oak.
- For Corian top, add “-CO” next to model number and specify color. Corian top is affixed to table top surface increasing overall table height by 1/2" and features 1/8" reveal.
- For custom wood finishes, please add one-time upcharge of \$400 List per color per order.
- Metal legs available in standard and premium finishes.

SPECIFY:

1. Model number
2. Wood species
3. Wood finish
4. Leg finish
5. Options, as applicable

ORDERING EXAMPLE:

#3230-3636-PF04
 36" Occasional Table
 Premium Leg Finish

INFINIUM
 OCCASIONAL TABLES

designed by michael bemis

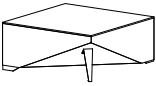

SIN #711-11

MODEL NUMBER	PRODUCT SPECIFICATIONS	TABLE TOP FINISH	
		VENEER OR LAMINATE	CORIAN (-CO)
3230-3636 	36" Square Occasional Table (has 2 rear and 2 front legs) W 36 D 36 H 16 83 lbs.	1911	3519

STANDARD LEG FINISHES:

- #06 Charcoal Grey
- #85 Metallic Silver
- #92 Polished Aluminum
- #95 Satin Black

For non-standard options, please contact Customer Service.

PREMIUM LEG FINISHES:

- #07 Gold Shimmer
- #08 Penny
- #09 Brown Sugar
- #83 Metallic Champagne
- #94 Cotton

CORIAN® TOP COLORS:

- Designer White
- Linen
- Rain Cloud
- Witch Hazel

OPTIONS (XXXX - REFERS TO TABLE MODEL NUMBER)

MODEL	DESCRIPTION	LIST
XXXX-NS02B	Non-Skid Glides	20
XXXX-PF04	Leg Premium Finish	135

Please note all dimensions listed above are nominal.

NOTES:

- Manufactured in Beech hardwood.
- All standard and custom finishes available on Beech.
- For custom wood finishes, please add one-time upcharge of \$400 List per color per order.
- Footring available in Chrome only.
- Maximum weight capacity is 275 lbs.

SPECIFY:

1. Model number
2. Wood species
3. Upholstery selection, as applicable

ORDERING EXAMPLE:

#4270
Stool, Wood Seat

INTIMA BARSTOOLS

designed by pld design group

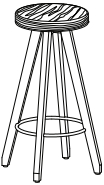
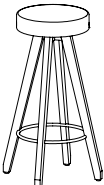

SIN #711-16

MODEL NUMBER	PRODUCT SPECIFICATIONS	FABRIC GRADES							LEATHER GRADES				
		COM	1	2	COL 3	4	5	6	7	8	L1	L2	L3
4270 	Stool, Wood Seat W 18 ¹ / ₄ D 18 ¹ / ₄ H 29 Seat Height 29 18 lbs.	638											
4275 	Stool, Upholstered Seat W 18 ¹ / ₄ D 18 ¹ / ₄ H 30 ¹ / ₄ Seat Height 30 ¹ / ₄ 1 ¹ / ₂ Yd. 16 lbs. COL 10 Sq. Ft. TB 133, add \$24 List	749	778	785	797	809	820	832	843	856	911	951	990

INTIMA LOUNGE

designed by pld design group



SIN #711-16

PRODUCT FEATURES:

- Metal leg height measures $7\frac{1}{4}$ " in front and $6\frac{1}{4}$ " in back.
- Metal legs available in #06 Charcoal Grey and #90 Metallic Silver.
- Premium metal finishes also available, refer to colors below. Please specify "-PF02" after model number and add \$80 List per chair.
- Non-skid glides available for hard surface floors. Please specify "-NS01" after model number and add \$20 List per chair.
- Optional casters offered in silver finish only. Please specify "-C01" after model number and add \$50 List. Leg finish will be #90 Metallic Silver to match unless otherwise specified.
- Mobile version comes standard with two locking casters in rear and two non-locking casters in front.
- Soft-tread casters available, silver color only. Please specify "-C05" after model number and add \$50 List per set (includes 4 casters).
- Optional pull available on back of mobile lounge chairs only, please specify "-P01" next to model number and add \$50 List per unit. Satin nickel finish.
- Maximum weight capacity is 350 lbs. for lounge chairs, 700 lbs. for love seats and 1000 lbs. for sofas.
- Please refer to page 5 for two-tone upholstery examples, yardage requirements and pricing.
- All dimensions are nominal.

PREMIUM METAL FINISH COLORS:

#07 Gold Shimmer

#08 Penny

#09 Brown Sugar

#83 Metallic Champagne

#94 Cotton

ROTATING TABLET:

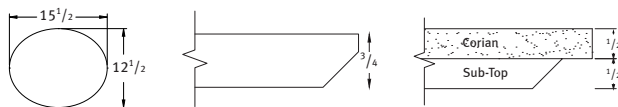

Tablet Shape

Veneer/Laminate Top - Edge Profile

Corian Top - Edge Profile

- Tablet affixed to right or left arm/side, as specified.
- Tablet size is $15\frac{1}{2}$ " W x $12\frac{1}{2}$ " D x $\frac{3}{4}$ " thick with 360-degree turning radius.
- Three tablet surface options: veneer, laminate or Corian.
- Veneer offered in Maple, Walnut and White Oak, in all standard and custom wood finishes.
- For custom wood finishes, please add one-time upcharge of \$400 List per color per order.
- Laminate is applied to tablet top surface only.
- For standard laminates, refer to Standard Finish Card.
- For custom laminates, add \$500 List per color per order. Pre-approval required, please contact Customer Service.
- Corian available in four standard colors. For non-standard options, please contact Customer Service for pricing.
- For maximum durability, a Corian tablet or laminate surface with a clear coat edge finish is recommended.
- Tablet mounting post will match leg finish unless otherwise specified (including premium finish selections).

INTIMA LOUNGE

designed by pld design group



SIN #711-16

CORIAN® COLORS:

- Designer White
- Linen
- Rain Cloud
- Witch Hazel

Corian® is a registered trademark of Dupont.

TABLET EDGE FINISH SPECIFICATIONS:

- For veneer tops, edge finish will always match the top finish color, unless otherwise specified.
- For standard laminate tops (laminate cannot be applied to the edge):
 - › Wood grain laminates, edge finish will match the laminate top color, unless otherwise specified.
 - › Solid color laminates, edge finish will be natural (clear coat) as standard, unless otherwise specified.
- For Corian tops:
 - › Designer White, Rain Cloud and Linen colors, edge will be white as standard, unless otherwise specified.
 - › Witch Hazel, edge will be natural (clear coat) as standard, unless otherwise specified.
- Edges are also available in all standard wood finishes, please specify. For custom edge finishes, please add one-time upcharge of \$400 List per color, per order.

POWER UNITS:

- Unit affixed to right side of seating units, as seated, unless otherwise specified.
- PB1 and PB2 dimensions: 5³/₄" W x 2¹/₂" D
- PB3 dimensions: 6¹/₂" W x 2¹/₂" D
- Metallic Silver or White finish with 108" electrical cord.
- UL listed.
- **Not available on units with casters.**

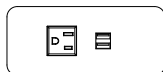

PB1

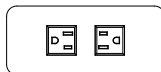

PB2



PB3

- PB1 unit features one outlet and two USB charging ports.
- PB2 unit features two outlets.
- PB3 unit features two outlets and two USB charging ports.

NOTES:

- Arm and armless models.
- Metal leg available in standard and premium metal finishes, refer to page 1 for options.
- Refer to page 5 for two-tone upholstery examples and yardage requirements.

SPECIFY:

1. Model number
2. Leg finish
3. Upholstery selection
4. Options, as applicable

ORDERING EXAMPLE:

#4210-TAR03-PB1-S-PF02



Lounge Chair
Veneer Tablet, Right
Power Band 1 Unit, Silver
Premium Leg Finish

**INTIMA
LOUNGE**

designed by pld design group

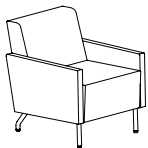

SIN #711-16

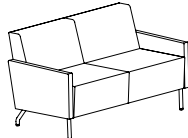
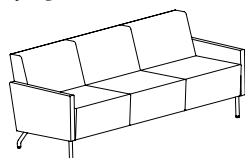
MODEL NUMBER	PRODUCT SPECIFICATIONS	FABRIC GRADES							LEATHER GRADES				
		COM	1	2	COL 3	4	5	6	7	8	L1	L2	L3
4210 	Q S 22" W Lounge Chair, Arms W 26 D 28 ¹ / ₄ H 30 ¹ / ₄ Seat Height 17 ¹ / ₂ Inside Seat Width 22 Inside Seat Depth 19 ¹ / ₂ Arm Height 22 ¹ / ₂ 3 ¹ / ₂ Yds. 53 lbs. COL 70 Sq. Ft. TB 133, add \$168 List	1470	1669	1717	1801	1886	1967	2051	2128	2213	2599	2882	3157
4211 	Q S 25" W Lounge Chair, Arms W 29 D 28 ¹ / ₄ H 30 ¹ / ₄ Seat Height 17 ¹ / ₂ Inside Seat Width 25 Inside Seat Depth 19 ¹ / ₂ Arm Height 22 ¹ / ₂ 3 ¹ / ₂ Yds. 55 lbs. COL 70 Sq. Ft. TB 133, add \$168 List	1550	1749	1797	1881	1966	2047	2131	2208	2293	2679	2962	3237
4212 	Love Seat, Arms W 54 D 28 ¹ / ₄ H 30 ¹ / ₄ Seat Height 17 ¹ / ₂ Inside Seat Width 50 Inside Seat Depth 19 ¹ / ₂ Arm Height 22 ¹ / ₂ 5 ¹ / ₄ Yds. 77 lbs. COL 105 Sq. Ft. TB 133, add \$252 List	2145	2443	2515	2642	2768	2890	3016	3132	3259	3838	4262	4676
4213 	Sofa, Arms W 79 D 28 ¹ / ₄ H 30 ¹ / ₄ Seat Height 17 ¹ / ₂ Inside Seat Width 75 Inside Seat Depth 19 ¹ / ₂ Arm Height 22 ¹ / ₂ 6 ³ / ₄ Yds. 96 lbs. COL 135 Sq. Ft. TB 133, add \$324 List	2670	3053	3145	3308	3471	3627	3790	3939	4102	4846	5392	5924

OPTIONS (XXXX - REFERS TO CHAIR MODEL NUMBER)

MODEL	DESCRIPTION	LIST
XXXX-TAR03	Veneer/Laminate Rotating Tablet, Right (as seated)	383
XXXX-TAL03	Veneer/Laminate Rotating Tablet, Left (as seated)	383
XXXX-TAR03-CO	Corian Rotating Tablet, Right (as seated)	686
XXXX-TAL03-CO	Corian Rotating Tablet, Left (as seated)	686
XXXX-PB1-S, XXXX-PB1-W	Power Band 1 (1 Power, 1 Data), Silver or White	413
XXXX-PB2-S, XXXX-PB2-W	Power Band 2 (Dual Power), Silver or White	322
XXXX-PB3-S, XXXX-PB3-W	Power Band 3 (Dual Power, 2 USB), Silver or White	429
XXXX-NS01	Non-Skid Glides	20
XXXX-C01	Casters (set of 4), silver finish only	50
XXXX-C05	Soft Tread Casters (set of 4)	50
XXXX-P01	Pull Handle (when specified with casters)	50
XXXX-PF02	Premium Leg Finish	80

Q S = Available on Quick-Ship Program (standard finishes only).

INTIMA LOUNGE

designed by pld design group



NOTES:

- Arm and armless models.
- Metal leg available in standard and premium metal finishes, refer to page 1 for options.
- Refer to page 5 for two-tone upholstery examples and yardage requirements.

SPECIFY:

1. Model number
2. Leg finish
3. Upholstery selection
4. Options, as applicable

ORDERING EXAMPLE:

#4221-TAR03-CO-PB1
 Armless Lounge Chair
 Corian Tablet, Right
 Power Band 1 Unit

SIN #711-16

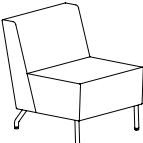
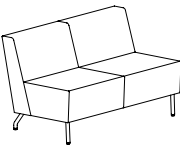
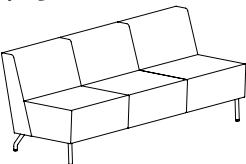
MODEL NUMBER	PRODUCT SPECIFICATIONS	FABRIC GRADES							LEATHER GRADES				
		COM	1	2	COL			8	L1	L2	L3		
4220	 <p>Q S 22" W Lounge Chair, Armless W 22 D 28¹/₄ H 30¹/₄ Seat Height 17¹/₂ Inside Seat Width 22 Inside Seat Depth 19¹/₂ 2¹/₄ Yds. 30 lbs. COL 45 Sq. Ft. TB 133, add \$108 List</p>	1278	1406	1437	1491	1545	1597	1652	1701	1756	2004	2186	2363
4221	 <p>Q S 25" W Lounge Chair, Armless W 25 D 28¹/₄ H 30¹/₄ Seat Height 17¹/₂ Inside Seat Width 25 Inside Seat Depth 19¹/₂ 2¹/₂ Yds. 33 lbs. COL 50 Sq. Ft. TB 133, add \$120 List</p>	1358	1500	1534	1595	1655	1713	1773	1828	1889	2164	2366	2563
4222	 <p>Love Seat, Armless W 50 D 28¹/₄ H 30¹/₄ Seat Height 17¹/₂ Inside Seat Width 50 Inside Seat Depth 19¹/₂ 3³/₄ Yds. 60 lbs. COL 75 Sq. Ft. TB 133, add \$180 List</p>	1952	2165	2216	2307	2397	2484	2575	2657	2748	3161	3464	3760
4223	 <p>Sofa, Armless W 75 D 28¹/₄ H 30¹/₄ Seat Height 17¹/₂ Inside Seat Width 75 Inside Seat Depth 19¹/₂ 5 Yds. 95 lbs. COL 100 Sq. Ft. TB 133, add \$240 List</p>	2475	2759	2827	2948	3069	3184	3305	3415	3536	4087	4491	4885

OPTIONS (XXXX - REFERS TO CHAIR MODEL NUMBER)

MODEL	DESCRIPTION	LIST
XXXX-TAL03	Veneer/Laminate Rotating Tablet, Left (as seated)	383
XXXX-TAR03-CO	Corian Rotating Tablet, Right (as seated)	686
XXXX-TAL03-CO	Corian Rotating Tablet, Left (as seated)	686
XXXX-PB1-S, XXXX-PB1-W	Power Band 1 (1 Power, 1 Data), Silver or White	413
XXXX-PB2-S, XXXX-PB2-W	Power Band 2 (Dual Power), Silver or White	322
XXXX-PB3-S, XXXX-PB3-W	Power Band 3 (Dual Power, 2 USB), Silver or White	429
XXXX-NS01	Non-Skid Glides	20
XXXX-C01	Casters (set of 4), silver finish only	50
XXXX-C05	Soft Tread Casters (set of 4)	50
XXXX-P01	Pull Handle (when specified with casters)	50
XXXX-PF02	Premium Leg Finish	80

Q S = Available on Quick-Ship Program (standard finishes only).

UPHOLSTERY COMBINATIONS:

For fabric, vinyl or leather upholstery combinations, refer to the pricing below:

- When combining **two** COM/COV/COL fabrics, or fabrics with the same grade, add the following (per unit):
 - › \$65 List for lounge chairs
 - › \$105 List for love seats
 - › \$130 List for sofas
- When combining **three or more** COM/COV/COL fabrics, or fabrics with the same grade, add the following (per unit):
 - › \$75 List for lounge chairs
 - › \$115 List for love seats
 - › \$140 List for sofas

- When combining different grades of fabric, price will be based on the highest grade specified.
- Two-tone upholstery examples and yardage requirements for the most common combinations are listed below. Additional combinations available, please contact Customer Service for yardage requirements and pricing.
- Note: Yardage amounts are based on fabric which is plain (i.e. non-directional) and a full 54" wide.
- **Appropriate upholstery code must be included on order.**

INTIMA LOUNGE

designed by pld design group



SIN #711-16

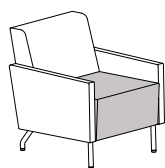

Code IL1
Model COM Requirement
 4210 Seat Cushion Only = 1 yd.
 Balance of Chair = 3 yds.

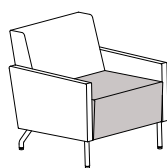

Code IL2
Model COM Requirement
 4211 Seat Cushion Only = 1 yd.
 Balance of Chair = 3 yds.

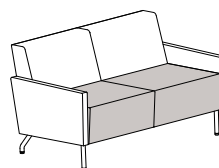

Code IL3
Model COM Requirement
 4212 Seat Cushion Only = 1³/₄ yds.
 Balance of Chair = 3³/₄ yds.

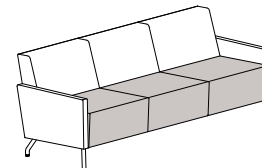

Code IL4
Model COM Requirement
 4213 Seat Cushion Only = 2¹/₄ yds.
 Balance of Chair = 4¹/₂ yds.

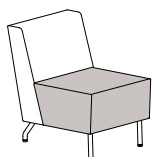

Code IL5
Model COM Requirement
 4220 Seat Cushion Only = 1 yd.
 Balance of Chair = 1¹/₂ yds.

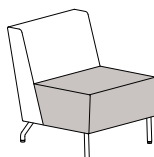

Code IL6
Model COM Requirement
 4221 Seat Cushion Only = 1 yd.
 Balance of Chair = 1¹/₂ yds.

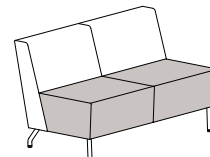

Code IL7
Model COM Requirement
 4222 Seat Cushion Only = 1³/₄ yds.
 Balance of Chair = 2¹/₄ yds.

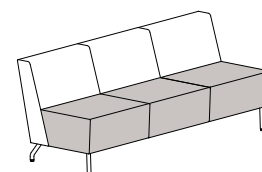

Code IL8
Model COM Requirement
 4223 Seat Cushion Only = 2¹/₄ yds.
 Balance of Chair = 3 yds.

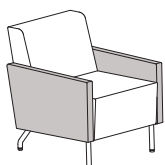

Code IL9
Model COM Requirement
 4210 Arm Panels Only = 2¹/₄ yds.
 Balance of Chair = 2¹/₄ yds.

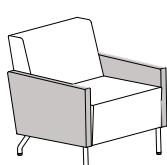

Code IL10
Model COM Requirement
 4211 Arm Panels Only = 2¹/₄ yds.
 Balance of Chair = 2¹/₄ yds.

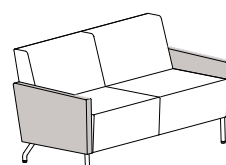

Code IL11
Model COM Requirement
 4212 Arm Panels Only = 2¹/₄ yds.
 Balance of Chair = 3¹/₂ yds.

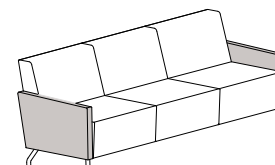

Code IL12
Model COM Requirement
 4213 Arm Panels Only = 2¹/₄ yds.
 Balance of Chair = 4¹/₂ yds.

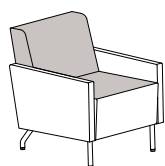

Code IL13
Model COM Requirement
 4210 Inside/Outside Back, Wings & Top of Seat = 1³/₄ yds.
 Balance of Chair = 2¹/₄ yds.

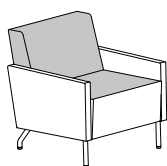

Code IL14
Model COM Requirement
 4211 Inside/Outside Back, Wings & Top of Seat = 1³/₄ yds.
 Balance of Chair = 2¹/₄ yds.

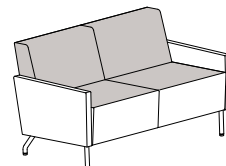

Code IL15
Model COM Requirement
 4212 Inside/Outside Back, Wings & Top of Seat = 3 yds.
 Balance of Chair = 2¹/₂ yds.

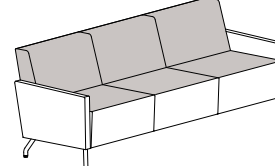

Code IL16
Model COM Requirement
 4213 Inside/Outside Back, Wings & Top of Seat = 3³/₄ yds.
 Balance of Chair = 2³/₄ yds.



INTIMA MODULAR

designed by pld design group

SIN #711-16

PRODUCT FEATURES:

- Two back options: low back (public) and high back (private).
- Metal leg height measures 7¹/₄" in front, 6¹/₄" in back and features 3³/₄" maximum height adjustability for leveling purposes .
- Metal legs available in #06 Charcoal Grey and #90 Metallic Silver.
- Premium metal finishes also available, refer to colors below. Please specify "-PF02" after model number and add \$80 List per chair.
- Non-skid glides available for hard surface floors. Please specify "-NS01" after model number and add \$20 List per chair.
- Lounge chairs available individually or in modular combinations.
- Maximum weight capacity is 350 lbs. for single-seat, corner and 45-degree units, 700 lbs. for two-seat units and 1000 lbs. for three-seat and quarter-round units.
- Please refer to pages 19-22 for two-tone upholstery examples, yardage requirements and pricing.
- All dimensions are nominal.

PREMIUM METAL FINISH COLORS:

- #07 Gold Shimmer
- #08 Penny
- #09 Brown Sugar
- #83 Metallic Champagne
- #94 Cotton

STANDING SHELF:

- Shelf available in Maple, Walnut and White Oak as well as laminate.
- All standard and custom finishes available.
- For custom wood finishes (to shelf, table and/or tablets), please add one-time upcharge of \$400 List per color per order.
- For standard laminates, refer to Standard Finish Card.
- For custom laminates, add \$500 List per color per order. Pre-approval required, please contact Customer Service.
- For veneer tops, edge finish will always match the top finish color, unless otherwise specified.
- For standard laminate tops (laminate cannot be applied to the edge):
 - › Wood grain laminates, edge finish will match the laminate top color, unless otherwise specified.
 - › All solid color laminates, edge finish will be natural (clear coat) as standard, unless otherwise specified.
- Shelf depth is 10".
- Shelf stands 39¹/₂" from the floor for private units and 29¹/₂" for public units, with a maximum weight allowance of 50 lbs.
- Metal support posts will match leg finish unless otherwise specified (including premium finish selections).
- Field-installation required.

FREE-STANDING PULL-UP TABLE:

- Table available in Maple, Walnut and White Oak.
- Table dimensions: 16" dia. x 27" high.
- All standard and custom wood finishes available.
- For custom wood finishes (to shelf, table and/or tablets), please add one-time upcharge of \$400 List per color per order.
- Laminate and Corian tops available.
- For standard laminates, refer to Standard Finish Card.
- For custom laminates, add \$500 List per color per order. Pre-approval required, please contact Customer Service.
- For Corian tops, specify "-CO" next to model number and select color.
- Corian top available in four standard colors. For non-standard colors, please contact Customer Service for pricing.
- Metal post and base will match leg finish unless otherwise specified (including premium finish selections).

INTIMA MODULAR

designed by pld design group



SIN #711-16

CORIAN® COLORS:

Designer White
Linen
Rain Cloud
Witch Hazel

Corian® is a registered trademark of Dupont.

ROTATING TABLET:

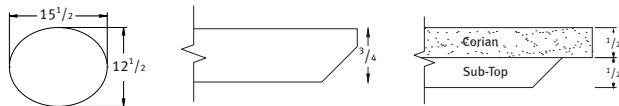

Tablet Shape

Veneer/Laminate Top - Edge Profile

Corian Top - Edge Profile

- Tablet affixed to right or left arm/side, as specified.
- Tablet size is 15¹/₂" W x 12¹/₂" D x 3³/₄" thick with 360-degree turning radius.
- Three tablet surface options: veneer, laminate and Corian.
- Veneer offered in Maple, Walnut and White Oak, in all standard and custom wood finishes.
- For custom wood finishes, please add one-time upcharge of \$400 List per color per order.
- Laminate is applied to tablet top surface only.
- For standard laminates, refer to Standard Finish Card.
- For custom laminates, add \$500 List per color per order. Pre-approval required, please contact Customer Service.
- Corian available in four standard colors. For non-standard options, please contact Customer Service for pricing.
- For maximum durability, a laminate or Corian surface with a clear coat edge finish is recommended.
- Tablet mounting post will match leg finish unless otherwise specified (including premium finish selections).

PULL-UP TABLE AND ROTATING TABLET EDGE FINISH SPECIFICATIONS:

- For veneer tops, edge finish will always match the top finish color, unless otherwise specified.
- For standard laminate tops (laminate cannot be applied to the edge):
 - › Wood grain laminates, edge finish will match the laminate top color, unless otherwise specified.
 - › Solid color laminates, edge finish will be natural (clear coat) as standard, unless otherwise specified.
- For Corian tops:
 - › Designer White, Rain Cloud and Linen colors, edge will be white as standard, unless otherwise specified.
 - › Witch Hazel, edge will be natural (clear coat) as standard, unless otherwise specified.
- Edges are also available in all standard wood finishes, please specify. For custom edge finishes, please add one-time upcharge of \$400 List per color, per order.

INTIMA MODULAR

designed by pld design group



SIN #711-16

POWER UNITS:

- Unit affixed to right side of seating units, as seated, unless otherwise specified.
- If specified in conjunction with a tablet, power unit will be mounted to same side as tablet unless otherwise specified.
- PB1 and PB2 dimensions: 5³/₄" W x 2¹/₂" D
- PB3 dimensions: 6¹/₂" W x 2¹/₂" D
- Metallic Silver or White finish with 108" electrical cord.
- UL listed.

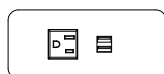

PB1

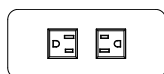

PB2

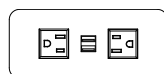

PB3

- PB1 unit features one outlet and two USB charging ports.
- PB2 unit features two outlets.
- PB3 unit features two outlets and two USB charging ports.
- In certain applications, daisy chain electrical units may be required. Please contact Customer Service for information and ordering assistance.

MODULAR ARRANGEMENTS:

- Optional ganging bracket available, please specify "GC02" with quantity and add \$50 List per set. One set contains two brackets for connecting two units together.
- Field assembly required.

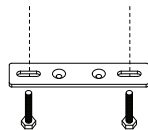

SHIPPING:

- All seating models ship blanket-wrap as standard.
- If cartoning is required, a 5% upcharge (based on the COM List Price), will be added to each applicable product. Please contact Customer Service for additional information and assistance with cartoning requirements as needed.

INTIMA MODULAR

designed by pld design group



SIN #711-16

NOTES:

- Private (high back) units stand 41 1/2" tall.
- Metal leg available in standard and premium metal finishes, refer to page 1 for options.
- Refer to pages 19-22 for two-tone upholstery examples and yardage requirements.

SPECIFY:

- Model number
- Leg finish
- Upholstery selection
- Options, as applicable

ORDERING EXAMPLE:

#4231-TAR03-PF02

Private Single-Seat
Veneer Rotating Tablet
Premium Leg Finish

MODEL NUMBER	PRODUCT SPECIFICATIONS	FABRIC GRADES							LEATHER GRADES				
		COM	1	2	COL	3	4	5	6	7	8	L1	L2
4230	Quarter-Round Unit Private (High Back) W 85 1/2 D 40 3/4 H 41 1/2 Seat Height 18 Inside Seat Width 39 3/4 - 71 1/4 Inside Seat Depth 22 1/2 8 1/4 Yds. 116 lbs. COL 165 Sq. Ft. TB 133, add \$396 List	3723	4191	4304	4503	4702	4893	5092	5274	5473	6383	7050	7700
4231	Single-Seat Unit Private (High Back) W 25 D 32 3/4 H 41 1/2 Seat Height 18 Inside Seat Width 25 Inside Seat Depth 22 1/2 3 Yds. 58 lbs. COL 60 Sq. Ft. TB 133, add \$144 List	1480	1651	1692	1764	1836	1906	1978	2044	2117	2448	2690	2926
4232	Two-Seat Unit Private (High Back) W 50 D 32 3/4 H 41 1/2 Seat Height 18 Inside Seat Width 50 Inside Seat Depth 22 1/2 4 1/2 Yds. 120 lbs. COL 90 Sq. Ft. TB 133, add \$216 List	2169	2425	2486	2595	2703	2807	2916	3015	3124	3620	3984	4338
4233	Three-Seat Unit Private (High Back) W 75 D 32 3/4 H 41 1/2 Seat Height 18 Inside Seat Width 75 Inside Seat Depth 22 1/2 6 1/4 Yds. 175 lbs. COL 125 Sq. Ft. TB 133, add \$300 List	3175	3530	3615	3766	3917	4061	4212	4350	4501	5190	5695	6188

OPTIONS (XXXX - REFERS TO CHAIR MODEL NUMBER)

MODEL	DESCRIPTION	LIST
XXXX-TAR03	Veneer/Laminate Rotating Tablet, Right (as seated)	383
XXXX-TAL03	Veneer/Laminate Rotating Tablet, Left (as seated)	383
XXXX-TAR03-CO	Corian Rotating Tablet, Right (as seated)	686
XXXX-TAL03-CO	Corian Rotating Tablet, Left (as seated)	686
XXXX-PB1-S, XXXX-PB1-W	Power Band 1 (1 Power, 1 Data), Silver or White	413
XXXX-PB2-S, XXXX-PB2-W	Power Band 2 (Dual Power), Silver or White	322
XXXX-PB3-S, XXXX-PB3-W	Power Band 3 (Dual Power, 2 USB), Silver or White	429
XXXX-NS01	Non-Skid Glides	20
XXXX-PF02	Premium Leg Finish	80
GC02 (order separately)	Ganging Connector	50

NOTES:

- Private (high back) units stand 41 1/2" tall.
- Metal leg available in standard and premium metal finishes, refer to page 1 for options.
- Refer to pages 19-22 for two-tone upholstery examples and yardage requirements.

SPECIFY:

1. Model number
2. Leg finish
3. Upholstery selection
4. Options, as applicable

ORDERING EXAMPLE:

#4281-NS01-PF02

Private 45-Degree
Non-Skid Glides
Premium Leg Finish

INTIMA MODULAR

designed by pld design group

SIN #711-16

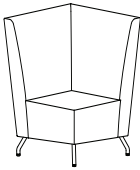
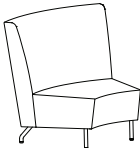
MODEL NUMBER	PRODUCT SPECIFICATIONS	FABRIC GRADES							LEATHER GRADES				
		COM	1	2	COL 3	4	5	6	7	8	L1	L2	L3
4234 	Corner Unit Private (High Back) W 32 D 32 H 41 1/2 Seat Height 18 Inside Seat Width 22 1/2 Inside Seat Depth 22 1/2 4 3/4 Yds. 60 lbs. COL 95 Sq. Ft. TB 133, add \$228 List	1775	2045	2110	2224	2339	2449	2564	2668	2783	3307	3691	4065
4281 	45-Degree Unit Private (High Back) W 46 1/2 D 32 H 41 1/2 Seat Height 18 Inside Seat Width 18 - 36 1/2 Inside Seat Depth 22 1/2 4 1/2 Yds. 65 lbs. COL 90 Sq. Ft. TB 133, add \$216 List	2098	2354	2415	2524	2632	2736	2845	2944	3053	3549	3913	4267

OPTIONS (XXXX - REFERS TO CHAIR MODEL NUMBER)

MODEL	DESCRIPTION	LIST
XXXX-TAR03	Veneer/Laminate Rotating Tablet, Right (as seated)	383
XXXX-TAL03	Veneer/Laminate Rotating Tablet, Left (as seated)	383
XXXX-TAR03-CO	Corian Rotating Tablet, Right (as seated)	686
XXXX-TAL03-CO	Corian Rotating Tablet, Left (as seated)	686
XXXX-PB1-S	Power Band 1 (1 Power, 1 Data), Silver	413
XXXX-PB1-W	Power Band 1 (1 Power, 1 Data), White	413
XXXX-PB2-S	Power Band 2 (Dual Power), Silver	322
XXXX-PB2-W	Power Band 2 (Dual Power), White	322
XXXX-PB3-S	Power Band 3 (Dual Power, 2 USB), Silver	429
XXXX-PB3-W	Power Band 3 (Dual Power, 2 USB), White	429
XXXX-NS01	Non-Skid Glides	20
XXXX-PF02	Premium Leg Finish	80
GC02 (order separately)	Ganging Connector	50

INTIMA MODULAR

designed by pld design group

NOTES:

- Public (low back) units stand 31 1/2" tall.
- Metal leg available in standard and premium metal finishes, refer to page 1 for options.
- Refer to pages 19-22 for two-tone upholstery examples and yardage requirements.

SPECIFY:



- Model number
- Leg finish
- Upholstery selection
- Options, as applicable

ORDERING EXAMPLE:

#4237-TAR03-PB1-S

Public Two-Seat Unit
Veneer Rotating Tablet
Power Band 1 Unit, Silver

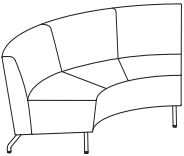
SIN #711-16

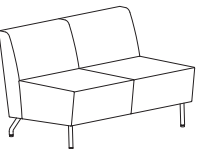
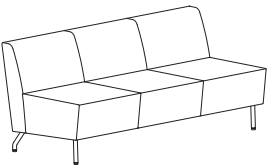
MODEL NUMBER	PRODUCT SPECIFICATIONS	FABRIC GRADES							LEATHER GRADES							
		COM	1	2	COL			3	4	5	6	7	8	L1	L2	L3
4235	 <p>Quarter-Round Unit Public (Low-Back) W 81 1/2 D 39 H 31 1/2 Seat Height 18 Inside Seat Width 39 1/2 - 66 1/2 Inside Seat Depth 22 1/2 6 1/2 Yds. 109 lbs. COL 130 Sq. Ft. TB 133, add \$312 List</p>	3645	4014	4103	4260	4417	4567	4724	4867	5024	5741	6266	6778			
4236	 <p>Single-Seat Unit Public (Low-Back) W 25 D 30 1/2 H 31 1/2 Seat Height 18 Inside Seat Width 25 Inside Seat Depth 22 1/2 2 1/2 Yds. 52 lbs. COL 50 Sq. Ft. TB 133, add \$120 List</p>	1404	1546	1580	1641	1701	1759	1819	1874	1935	2210	2412	2609			
4237	 <p>Two-Seat Unit Public (Low-Back) W 50 D 30 1/2 H 31 1/2 Seat Height 18 Inside Seat Width 50 Inside Seat Depth 22 1/2 4 Yds. 108 lbs. COL 80 Sq. Ft. TB 133, add \$192 List</p>	2032	2259	2314	2410	2507	2599	2696	2784	2881	3322	3645	3960			
4238	 <p>Three-Seat Unit Public (Low-Back) W 75 D 30 1/2 H 31 1/2 Seat Height 18 Inside Seat Width 75 Inside Seat Depth 22 1/2 5 1/4 Yds. 158 lbs. COL 105 Sq. Ft. TB 133, add \$252 List</p>	2744	3042	3114	3241	3367	3489	3615	3731	3858	4437	4861	5275			

OPTIONS (XXXX - REFERS TO CHAIR MODEL NUMBER)

MODEL	DESCRIPTION	LIST
XXXX-TAR03	Veneer/Laminate Rotating Tablet, Right (as seated)	383
XXXX-TAL03	Veneer/Laminate Rotating Tablet, Left (as seated)	383
XXXX-TAR03-CO	Corian Rotating Tablet, Right (as seated)	686
XXXX-TAL03-CO	Corian Rotating Tablet, Left (as seated)	686
XXXX-PB1-S, XXXX-PB1-W	Power Band 1 (1 Power, 1 Data), Silver or White	413
XXXX-PB2-S, XXXX-PB2-W	Power Band 2 (Dual Power), Silver or White	322
XXXX-PB3-S, XXXX-PB3-W	Power Band 3 (Dual Power, 2 USB), Silver or White	429
XXXX-NS01	Non-Skid Glides	20
XXXX-PF02	Premium Leg Finish	80
GC02 (order separately)	Ganging Connector	50

NOTES:

- Public (low back) units stand 31¹/₂" tall.
- Metal leg available in standard and premium metal finishes, refer to page 1 for options.
- Refer to pages 19-22 for two-tone upholstery examples and yardage requirements.

SPECIFY:

1. Model number
2. Leg finish
3. Upholstery selection
4. Options, as applicable

ORDERING EXAMPLE:



#4286-NS01
Public 45-Degree
Non-Skid Glides

INTIMA MODULAR

designed by pld design group

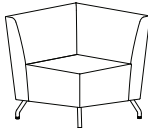

SIN #711-16

MODEL NUMBER	PRODUCT SPECIFICATIONS	FABRIC GRADES							LEATHER GRADES				
		COM	1	2	COL 3	4	5	6	7	8	L1	L2	L3
4239 	Corner Unit Public (Low Back) W 30 ¹ / ₂ D 30 ¹ / ₂ H 31 ¹ / ₂ Seat Height 18 Inside Seat Width 22 ¹ / ₂ Inside Seat Depth 22 ¹ / ₂ 3 ³ / ₄ Yds. 50 lbs. COL 75 Sq. Ft. TB 133, add \$180 List	1623	1836	1887	1978	2068	2155	2246	2328	2419	2832	3135	3431
4286 	45-Degree Unit Public (Low Back) W 46 ¹ / ₂ D 34 H 31 ¹ / ₂ Seat Height 18 Inside Seat Width 18 - 36 ¹ / ₂ Inside Seat Depth 22 ¹ / ₂ 4 Yds. 55 lbs. COL 80 Sq. Ft. TB 133, add \$192 List	2025	2252	2307	2403	2500	2592	2689	2777	2874	3315	3638	3953

OPTIONS (XXXX - REFERS TO CHAIR MODEL NUMBER)

MODEL	DESCRIPTION	LIST
XXXX-TAR03	Veneer/Laminate Rotating Tablet, Right (as seated)	383
XXXX-TAL03	Veneer/Laminate Rotating Tablet, Left (as seated)	383
XXXX-TAR03-CO	Corian Rotating Tablet, Right (as seated)	686
XXXX-TAL03-CO	Corian Rotating Tablet, Left (as seated)	686
XXXX-PB1-S	Power Band 1 (1 Power, 1 Data), Silver	413
XXXX-PB1-W	Power Band 1 (1 Power, 1 Data), White	413
XXXX-PB2-S	Power Band 2 (Dual Power), Silver	322
XXXX-PB2-W	Power Band 2 (Dual Power), White	322
XXXX-PB3-S	Power Band 3 (Dual Power, 2 USB), Silver	429
XXXX-PB3-W	Power Band 3 (Dual Power, 2 USB), White	429
XXXX-NS01	Non-Skid Glides	20
XXXX-PF02	Premium Leg Finish	80
GC02 (order separately)	Ganging Connector	50

INTIMA MODULAR

designed by pld design group



SIN #711-16

NOTES:

- Private (high back) units with headrest stand 51 1/2" tall.
- Non-removable headrest is supported with metal stand-offs. Finish will match specified leg finish as standard (including premium finish selections).
- Metal leg available in standard and premium metal finishes, refer to page 1 for options.
- Refer to pages 19-22 for two-tone upholstery examples and yardage requirements.

SPECIFY:

1. Model number
2. Leg finish
3. Upholstery selection
4. Options, as applicable

ORDERING EXAMPLE:

#4240-PF02-PB1-W

Private Quarter-Round with Headrest
Premium Leg Finish
Power Band 1 Unit, White

MODEL NUMBER	PRODUCT SPECIFICATIONS	FABRIC GRADES							LEATHER GRADES							
		COM	1	2	COL			3	4	5	6	7	8	L1	L2	L3
4240	Quarter-Round Unit with Headrest Private (High Back) W 88 D 42 1/2 H 51 1/2 Seat Height 18 Inside Seat Width 39 3/4 - 71 1/4 Inside Seat Depth 22 1/2 11 1/4 Yds. 135 lbs. COL 225 Sq. Ft. TB 133, add \$540 List	4176	4814	4968	5240	5511	5771	6043	6291	6563	7803	8712	9598			
4241	Single-Seat Unit with Headrest Private (High Back) W 25 D 34 1/2 H 51 1/2 Seat Height 18 Inside Seat Width 25 Inside Seat Depth 22 1/2 3 1/4 Yds. 65 lbs. COL 65 Sq. Ft. TB 133, add \$156 List	1616	1801	1845	1924	2002	2077	2156	2227	2306	2664	2927	3183			
4242	Two-Seat Unit with Headrest Private (High Back) W 50 D 34 1/2 H 51 1/2 Seat Height 18 Inside Seat Width 50 Inside Seat Depth 22 1/2 5 1/2 Yds. 130 lbs. COL 110 Sq. Ft. TB 133, add \$264 List	2504	2816	2891	3024	3157	3284	3417	3538	3671	4277	4722	5155			
4243	Three-Seat Unit with Headrest Private (High Back) W 75 D 34 1/2 H 51 1/2 Seat Height 18 Inside Seat Width 75 Inside Seat Depth 22 1/2 7 3/4 Yds. 195 lbs. COL 155 Sq. Ft. TB 133, add \$372 List	3536	3976	4082	4269	4456	4635	4822	4993	5180	6035	6661	7272			

OPTIONS (XXXX - REFERS TO CHAIR MODEL NUMBER)

MODEL	DESCRIPTION	LIST
XXXX-TAR03	Veneer/Laminate Rotating Tablet, Right (as seated)	383
XXXX-TAL03	Veneer/Laminate Rotating Tablet, Left (as seated)	383
XXXX-TAR03-CO	Corian Rotating Tablet, Right (as seated)	686
XXXX-TAL03-CO	Corian Rotating Tablet, Left (as seated)	686
XXXX-PB1-S, XXXX-PB1-W	Power Band 1 (1 Power, 1 Data), Silver or White	413
XXXX-PB2-S, XXXX-PB2-W	Power Band 2 (Dual Power), Silver or White	322
XXXX-PB3-S, XXXX-PB3-W	Power Band 3 (Dual Power, 2 USB), Silver or White	429
XXXX-NS01	Non-Skid Glides	20
XXXX-PF02	Premium Leg Finish	80
GC02 (order separately)	Ganging Connector	50

NOTES:

- Private (high back) units with headrest stand 51 1/2" tall.
- Non-removable headrest is supported with metal stand-offs. Finish will match specified leg finish as standard (including premium finish selections).
- Refer to pages 19-22 for two-tone upholstery examples and yardage requirements.

SPECIFY:

1. Model number
2. Leg finish
3. Upholstery selection
4. Options, as applicable

ORDERING EXAMPLE:

#4244-PF02

Private Corner with Headrest
Premium Leg Finish

**INTIMA
MODULAR**

designed by pld design group

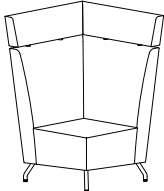
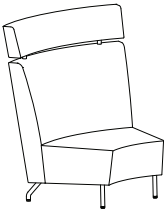

SIN #711-16

MODEL NUMBER	PRODUCT SPECIFICATIONS	FABRIC GRADES							LEATHER GRADES							
		COM	1	2	COL			3	4	5	6	7	8	L1	L2	L3
4244	 <p>Corner Unit with Headrest Private (High Back) W 34 3/4 D 33 3/4 H 51 1/2 Seat Height 18 Inside Seat Width 22 1/2 Inside Seat Depth 22 1/2 5 3/4 Yds. 70 lbs. COL 115 Sq. Ft. TB 133, add \$276 List</p>	2127	2454	2532	2671	2810	2943	3081	3208	3347	3981	4446	4899			
4282	 <p>45-Degree Unit with Headrest Private (High Back) W 48 D 34 H 51 1/2 Seat Height 18 Inside Seat Width 18 - 36 1/2 Inside Seat Depth 22 1/2 5 1/2 Yds. 75 lbs. COL 110 Sq. Ft. TB 133, add \$264 List</p>	2538	2850	2925	3058	3191	3318	3451	3572	3705	4311	4756	5189			

OPTIONS (XXXX - REFERS TO CHAIR MODEL NUMBER)

MODEL	DESCRIPTION	LIST
XXXX-TAR03	Veneer/Laminate Rotating Tablet, Right (as seated)	383
XXXX-TAL03	Veneer/Laminate Rotating Tablet, Left (as seated)	383
XXXX-TAR03-CO	Corian Rotating Tablet, Right (as seated)	686
XXXX-TAL03-CO	Corian Rotating Tablet, Left (as seated)	686
XXXX-PB1-S	Power Band 1 (1 Power, 1 Data), Silver	413
XXXX-PB1-W	Power Band 1 (1 Power, 1 Data), White	413
XXXX-PB2-S	Power Band 2 (Dual Power), Silver	322
XXXX-PB2-W	Power Band 2 (Dual Power), White	322
XXXX-PB3-S	Power Band 3 (Dual Power, 2 USB), Silver	429
XXXX-PB3-W	Power Band 3 (Dual Power, 2 USB), White	429
XXXX-NS01	Non-Skid Glides	20
XXXX-PF02	Premium Leg Finish	80
GC02 (order separately)	Ganging Connector	50

INTIMA MODULAR

designed by pld design group



NOTES:

- Public (low back) units with headrest stand 41 1/2" tall.
- Non-removable headrest is supported with metal stand-offs. Finish will match specified leg finish as standard (including premium finish selections).
- Metal leg available in standard and premium metal finishes, refer to page 1 for options.
- Refer to pages 19-22 for two-tone upholstery examples and yardage requirements.

SPECIFY:



1. Model number
2. Leg finish
3. Upholstery selection
4. Options, as applicable

ORDERING EXAMPLE:

#4247-TAR03-CO-PB1-S

Public Two-Seat with Headrest
Corian Tablet, Right
Power Band 1 Unit, Silver

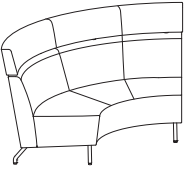
SIN #711-16

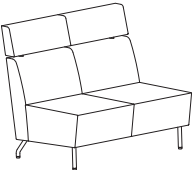
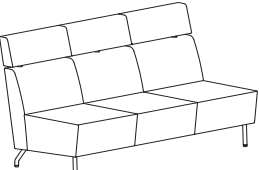
MODEL NUMBER	PRODUCT SPECIFICATIONS	FABRIC GRADES							LEATHER GRADES							
		COM	1	2	COL			3	4	5	6	7	8	L1	L2	L3
4245	 <p>Quarter-Round Unit with Headrest Public (Low-Back) W 84 1/2 D 40 1/2 H 41 1/2 Seat Height 18 Inside Seat Width 39 1/2 - 66 1/2 Inside Seat Depth 22 1/2 8 1/2 Yds. 129 lbs. COL 170 Sq. Ft. TB 133, add \$408 List</p>	4101	4583	4699	4905	5110	5306	5512	5699	5904	6841	7529	8198			
4246	 <p>Single-Seat Unit with Headrest Public (Low-Back) W 25 D 32 H 41 1/2 Seat Height 18 Inside Seat Width 25 Inside Seat Depth 22 1/2 2 3/4 Yds. 59 lbs. COL 55 Sq. Ft. TB 133, add \$132 List</p>	1541	1697	1735	1801	1868	1931	1998	2058	2125	2428	2650	2867			
4247	 <p>Two-Seat Unit with Headrest Public (Low-Back) W 50 D 32 H 41 1/2 Seat Height 18 Inside Seat Width 50 Inside Seat Depth 22 1/2 4 3/4 Yds. 118 lbs. COL 95 Sq. Ft. TB 133, add \$228 List</p>	2426	2696	2761	2875	2990	3100	3215	3319	3434	3958	4342	4716			
4248	 <p>Three-Seat Unit with Headrest Public (Low-Back) W 75 D 32 H 41 1/2 Seat Height 18 Inside Seat Width 75 Inside Seat Depth 22 1/2 6 1/2 Yds. 178 lbs. COL 130 Sq. Ft. TB 133, add \$312 List</p>	3204	3573	3662	3819	3976	4126	4283	4426	4583	5300	5825	6337			

OPTIONS (XXXX - REFERS TO CHAIR MODEL NUMBER)

MODEL	DESCRIPTION	LIST
XXXX-TAR03	Veneer/Laminate Rotating Tablet, Right (as seated)	383
XXXX-TAL03	Veneer/Laminate Rotating Tablet, Left (as seated)	383
XXXX-TAR03-CO	Corian Rotating Tablet, Right (as seated)	686
XXXX-TAL03-CO	Corian Rotating Tablet, Left (as seated)	686
XXXX-PB1-S, XXXX-PB1-W	Power Band 1 (1 Power, 1 Data), Silver or White	413
XXXX-PB2-S, XXXX-PB2-W	Power Band 2 (Dual Power), Silver or White	322
XXXX-PB3-S, XXXX-PB3-W	Power Band 3 (Dual Power, 2 USB), Silver or White	429
XXXX-NS01	Non-Skid Glides	20
XXXX-PF02	Premium Leg Finish	80
GC02 (order separately)	Ganging Connector	50

NOTES:

- Public (low back) units with headrest stand 41 1/2" tall.
- Non-removable headrest is supported with metal stand-offs. Finish will match specified leg finish as standard (including premium finish selections).
- Metal leg available in standard and premium metal finishes, refer to page 1 for options.
- Refer to pages 19-22 for two-tone upholstery examples and yardage requirements.

SPECIFY:

1. Model number
2. Leg finish
3. Upholstery selection
4. Options, as applicable

ORDERING EXAMPLE:

#4287-TAR03-NS01



Public 45-Degree with Headrest
Veneer Tablet, Right
Non-Skid Glides

INTIMA MODULAR

designed by pld design group

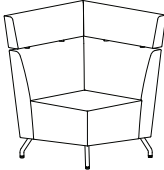

SIN #711-16

MODEL NUMBER	PRODUCT SPECIFICATIONS	FABRIC GRADES							LEATHER GRADES				
		COM	1	2	COL 3	4	5	6	7	8	L1	L2	L3
4249	 <p>Corner Unit with Headrest Public (Low Back) W 32 D 32 H 41 1/2 Seat Height 18 Inside Seat Width 22 1/2 Inside Seat Depth 22 1/2 4 3/4 Yds. 58 lbs. COL 95 Sq. Ft. TB 133, add \$228 List</p>	1944	2214	2279	2393	2508	2618	2733	2837	2952	3476	3860	4234
4287	 <p>45-Degree Unit with Headrest Public (Low Back) W 48 D 36 H 41 1/2 Seat Height 18 Inside Seat Width 18 - 36 1/2 Inside Seat Depth 22 1/2 5 Yds. 62 lbs. COL 100 Sq. Ft. TB 133, add \$240 List</p>	2466	2750	2818	2939	3060	3175	3296	3406	3527	4078	4482	4876

OPTIONS (XXXX - REFERS TO CHAIR MODEL NUMBER)

MODEL	DESCRIPTION	LIST
XXXX-TAR03	Veneer/Laminate Rotating Tablet, Right (as seated)	383
XXXX-TAL03	Veneer/Laminate Rotating Tablet, Left (as seated)	383
XXXX-TAR03-CO	Corian Rotating Tablet, Right (as seated)	686
XXXX-TAL03-CO	Corian Rotating Tablet, Left (as seated)	686
XXXX-PB1-S	Power Band 1 (1 Power, 1 Data), Silver	413
XXXX-PB1-W	Power Band 1 (1 Power, 1 Data), White	413
XXXX-PB2-S	Power Band 2 (Dual Power), Silver	322
XXXX-PB2-W	Power Band 2 (Dual Power), White	322
XXXX-PB3-S	Power Band 3 (Dual Power, 2 USB), Silver	429
XXXX-PB3-W	Power Band 3 (Dual Power, 2 USB), White	429
XXXX-NS01	Non-Skid Glides	20
XXXX-PF02	Premium Leg Finish	80
GC02 (order separately)	Ganging Connector	50

INTIMA MODULAR

designed by pld design group



SIN #711-16

NOTES:

- Priyate (high back) units with headrest stand 51 1/2" tall.
- Non-removable headrest is supported with metal stand-offs. Finish will match specified leg finish as standard (including premium finish selections).
- 10" wide shelf stands 39 1/2" from the floor and has a maximum weight allowance of 50 lbs.
- Shelf available in Maple, Walnut and White Oak as well as laminate.
- Metal leg available in standard and premium metal finishes, refer to page 1 for options.
- Refer to pages 19-22 for two-tone upholstery examples and yardage requirements.

SPECIFY:

1. Model number
2. Leg finish
3. Upholstery selection
4. Shelf wood species
5. Shelf wood finish
6. Options, as applicable

ORDERING EXAMPLE:

#4250-PF02

Private Quarter-Round with Shelf and Headrest Premium Leg Finish

MODEL NUMBER	PRODUCT SPECIFICATIONS	FABRIC GRADES							LEATHER GRADES							
		COM	1	2	COL			3	4	5	6	7	8	L1	L2	L3
4250	Quarter-Round Unit with Shelf and Headrest, Private (High Back) W 91 1/2 D 48 3/4 H 51 1/2 Seat Height 18 Inside Seat Width 39 3/4 - 71 1/4 Inside Seat Depth 22 1/2 11 1/4 Yds. 175 lbs. COL 225 Sq. Ft. TB 133, add \$540 List	5309	5947	6101	6373	6644	6904	7176	7424	7696	8936	9845	10731			
4252	Two-Seat Unit with Shelf and Headrest, Private (High Back) W 50 D 40 3/4 H 51 1/2 Seat Height 18 Inside Seat Width 50 Inside Seat Depth 22 1/2 5 1/2 Yds. 145 lbs. COL 110 Sq. Ft. TB 133, add \$264 List	3100	3412	3487	3620	3753	3880	4013	4134	4267	4873	5318	5751			
4253	Three-Seat Unit with Shelf and Headrest, Private (High Back) W 75 D 40 3/4 H 51 1/2 Seat Height 18 Inside Seat Width 75 Inside Seat Depth 22 1/2 7 3/4 Yds. 210 lbs. COL 155 Sq. Ft. TB 133, add \$372 List	4141	4581	4687	4874	5061	5240	5427	5598	5785	6640	7266	7877			
4283	45-Degree Unit with Shelf and Headrest, Private (High Back) W 49 D 44 H 51 1/2 Seat Height 18 Inside Seat Width 18 - 36 1/2 Inside Seat Depth 22 1/2 5 1/2 Yds. 100 lbs. COL 110 Sq. Ft. TB 133, add \$264 List	3640	3952	4027	4160	4293	4420	4553	4674	4807	5413	5858	6291			

OPTIONS (XXXX - REFERS TO CHAIR MODEL NUMBER)

MODEL	DESCRIPTION	LIST
XXXX-TAR03	Veneer/Laminate Rotating Tablet, Right (as seated)	383
XXXX-TAL03	Veneer/Laminate Rotating Tablet, Left (as seated)	383
XXXX-TAR03-CO	Corian Rotating Tablet, Right (as seated)	686
XXXX-TAL03-CO	Corian Rotating Tablet, Left (as seated)	686
XXXX-PB1-S, XXXX-PB1-W	Power Band 1 (1 Power, 1 Data), Silver or White	413
XXXX-PB2-S, XXXX-PB2-W	Power Band 2 (Dual Power), Silver or White	322
XXXX-PB3-S, XXXX-PB3-W	Power Band 3 (Dual Power, 2 USB), Silver or White	429
XXXX-NS01	Non-Skid Glides	20
XXXX-PF02	Premium Leg Finish	80
GC02 (order separately)	Ganging Connector	50

NOTES:

- Public (low back) units with headrest stand 41¹/₂" tall.
- Non-removable headrest is supported with metal stand-offs. Finish will match specified leg finish as standard (including premium finish selections).
- 10" wide shelf stands 29¹/₂" from the floor and has a maximum weight allowance of 50 lbs.
- Shelf available in Maple, Walnut and White Oak as well as laminate.
- Metal leg available in standard and premium metal finishes, refer to page 1 for options.
- Refer to pages 19-22 for two-tone upholstery examples and yardage requirements.

SPECIFY:

1. Model number
2. Leg finish
3. Upholstery selection
4. Shelf wood species
5. Shelf wood finish
6. Options, as applicable

ORDERING EXAMPLE:

#4257-TAL03-NS01
Public Two-Seat with Shelf and Headrest
Veneer Tablet, Left
Non-Skid Glides

INTIMA MODULAR

designed by pld design group

SIN #711-16

MODEL NUMBER	PRODUCT SPECIFICATIONS	FABRIC GRADES							LEATHER GRADES							
		COM	1	2	COL			3	4	5	6	7	8	L1	L2	L3
4255	Quarter-Round Unit with Shelf and Headrest, Public (Low-Back) W 87 D 46 ¹ / ₂ H 41 ¹ / ₂ Seat Height 18 Inside Seat Width 39 ¹ / ₂ - 66 ¹ / ₂ Inside Seat Depth 22 ¹ / ₂ 8 Yds. 145 lbs. COL 160 Sq. Ft. TB 133, add \$384 List	5234	5688	5797	5990	6184	6368	6562	6738	6931	7813	8460	9090			
4257	Two-Seat Unit with Shelf and Headrest, Public (Low-Back) W 50 D 39 H 41 ¹ / ₂ Seat Height 18 Inside Seat Width 50 Inside Seat Depth 22 ¹ / ₂ 4 ³ / ₄ Yds. 130 lbs. COL 95 Sq. Ft. TB 133, add \$228 List	3023	3293	3358	3472	3587	3697	3812	3916	4031	4555	4939	5313			
4258	Three-Seat Unit with Shelf and Headrest, Public (Low-Back) W 75 D 39 H 41 ¹ / ₂ Seat Height 18 Inside Seat Width 75 Inside Seat Depth 22 ¹ / ₂ 6 ¹ / ₂ Yds. 190 lbs. COL 130 Sq. Ft. TB 133, add \$312 List	4085	4454	4543	4700	4857	5007	5164	5307	5464	6181	6706	7218			
4288	45-Degree Unit with Shelf and Headrest, Public (Low Back) W 49 D 44 H 41 ¹ / ₂ Seat Height 18 Inside Seat Width 18 - 36 ¹ / ₂ Inside Seat Depth 22 ¹ / ₂ 5 Yds. 87 lbs. COL 100 Sq. Ft. TB 133, add \$240 List	3565	3849	3917	4038	4159	4274	4395	4505	4626	5177	5581	5975			

OPTIONS (XXXX - REFERS TO CHAIR MODEL NUMBER)

MODEL	DESCRIPTION	LIST
XXXX-TAR03	Veneer/Laminate Rotating Tablet, Right (as seated)	383
XXXX-TAL03	Veneer/Laminate Rotating Tablet, Left (as seated)	383
XXXX-TAR03-CO	Corian Rotating Tablet, Right (as seated)	686
XXXX-TAL03-CO	Corian Rotating Tablet, Left (as seated)	686
XXXX-PB1-S, XXXX-PB1-W	Power Band 1 (1 Power, 1 Data), Silver or White	413
XXXX-PB2-S, XXXX-PB2-W	Power Band 2 (Dual Power), Silver or White	322
XXXX-PB3-S, XXXX-PB3-W	Power Band 3 (Dual Power, 2 USB), Silver or White	429
XXXX-NS01	Non-Skid Glides	20
XXXX-PF02	Premium Leg Finish	80
GC02 (order separately)	Ganging Connector	50

INTIMA MODULAR

designed by pld design group

NOTES:

- Private (high back) units stand 41¹/₂" tall.
- 10" wide shelf stands 39¹/₂" from the floor and has a maximum weight allowance of 50 lbs.
- Shelf available in Maple, Walnut and White Oak as well as laminate.
- Metal leg available in standard and premium metal finishes, refer to page 1 for options.
- Refer to pages 19-22 for two-tone upholstery examples and yardage requirements.

SPECIFY:

1. Model number
2. Leg finish
3. Upholstery selection
4. Shelf wood species
5. Shelf wood finish
6. Options, as applicable

ORDERING EXAMPLE:

#4262-TAL03-CO-PB1-W

Private Two-Seat with Shelf
Corian Tablet, Left
Power Band 1 Unit, White

SIN #711-16

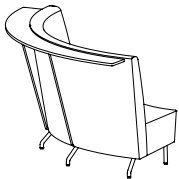
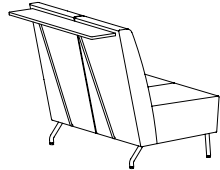
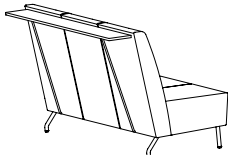
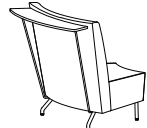
MODEL NUMBER	PRODUCT SPECIFICATIONS	FABRIC GRADES							LEATHER GRADES							
		COM	1	2	COL			3	4	5	6	7	8	L1	L2	L3
4260	 <p>Quarter-Round Unit with Shelf Private (High Back) W 91¹/₂ D 48³/₄ H 41¹/₂ Seat Height 18 Inside Seat Width 39³/₄ - 71¹/₄ Inside Seat Depth 22¹/₂ 8¹/₄ Yds. 143 lbs. COL 165 Sq. Ft. TB 133, add \$396 List</p>	4855	5323	5436	5635	5834	6025	6224	6406	6605	7515	8182	8832			
4262	 <p>Two-Seat Unit with Shelf Private (High Back) W 50 D 40³/₄ H 41¹/₂ Seat Height 18 Inside Seat Width 50 Inside Seat Depth 22¹/₂ 4¹/₂ Yds. 126 lbs. COL 90 Sq. Ft. TB 133, add \$216 List</p>	2703	2959	3020	3129	3237	3341	3450	3549	3658	4154	4518	4872			
4263	 <p>Three-Seat Unit with Shelf Private (High Back) W 75 D 40³/₄ H 41¹/₂ Seat Height 18 Inside Seat Width 75 Inside Seat Depth 22¹/₂ 6¹/₄ Yds. 188 lbs. COL 125 Sq. Ft. TB 133, add \$300 List</p>	3828	4183	4268	4419	4570	4714	4865	5003	5154	5843	6348	6841			
4284	 <p>45-Degree Unit with Shelf Private (High Back) W 49 D 44 H 41¹/₂ Seat Height 18 Inside Seat Width 18 - 36¹/₂ Inside Seat Depth 22¹/₂ 5¹/₂ Yds. 90 lbs. COL 110 Sq. Ft. TB 133, add \$264 List</p>	3199	3511	3586	3719	3852	3979	4112	4233	4366	4972	5417	5850			

OPTIONS (XXXX - REFERS TO CHAIR MODEL NUMBER)

MODEL	DESCRIPTION	LIST
XXXX-TAR03	Veneer/Laminate Rotating Tablet, Right (as seated)	383
XXXX-TAL03	Veneer/Laminate Rotating Tablet, Left (as seated)	383
XXXX-TAR03-CO	Corian Rotating Tablet, Right (as seated)	686
XXXX-TAL03-CO	Corian Rotating Tablet, Left (as seated)	686
XXXX-PB1-S, XXXX-PB1-W	Power Band 1 (1 Power, 1 Data), Silver or White	413
XXXX-PB2-S, XXXX-PB2-W	Power Band 2 (Dual Power), Silver or White	322
XXXX-PB3-S, XXXX-PB3-W	Power Band 3 (Dual Power, 2 USB), Silver or White	429
XXXX-NS01	Non-Skid Glides	20
XXXX-PF02	Premium Leg Finish	80
GC02 (order separately)	Ganging Connector	50

NOTES:

- Public (low back) units stand 31 1/2" tall.
- 10" wide shelf stands 29 1/2" from the floor and has a maximum weight allowance of 50 lbs.
- Shelf available in Maple, Walnut and White Oak as well as laminate.
- Metal leg available in standard and premium metal finishes, refer to page 1 for options.
- Refer to pages 19-22 for two-tone upholstery examples and yardage requirements.

SPECIFY:

1. Model number
2. Leg finish
3. Upholstery selection
4. Shelf wood species
5. Shelf wood finish
6. Options, as applicable

ORDERING EXAMPLE:

#4265-NS01-PF02
 Public Quarter-Round with Shelf
 Non-Skid Glides
 Premium Leg Finish

INTIMA MODULAR

designed by pld design group

SIN #711-16

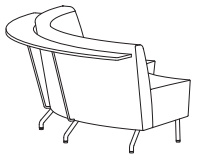
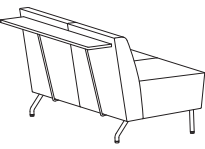
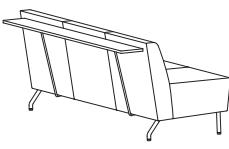
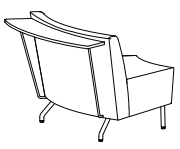
MODEL NUMBER	PRODUCT SPECIFICATIONS	FABRIC GRADES							LEATHER GRADES				
		COM	1	2	COL 3	4	5	6	7	8	L1	L2	L3
4265 	Quarter-Round Unit with Shelf Public (Low-Back) W 87 D 46 1/2 H 31 1/2 Seat Height 18 Inside Seat Width 39 1/2 - 66 1/2 Inside Seat Depth 22 1/2 6 1/2 Yds. 130 lbs. COL 130 Sq. Ft. TB 133, add \$312 List	4780	5149	5238	5395	5552	5702	5859	6002	6159	6876	7401	7913
4267 	Two-Seat Unit with Shelf Public (Low-Back) W 50 D 39 H 31 1/2 Seat Height 18 Inside Seat Width 50 Inside Seat Depth 22 1/2 4 Yds. 120 lbs. COL 80 Sq. Ft. TB 133, add \$192 List	2629	2856	2911	3007	3104	3196	3293	3381	3478	3919	4242	4557
4268 	Three-Seat Unit with Shelf Public (Low-Back) W 75 D 39 H 31 1/2 Seat Height 18 Inside Seat Width 75 Inside Seat Depth 22 1/2 5 1/4 Yds. 175 lbs. COL 105 Sq. Ft. TB 133, add \$252 List	3611	3909	3981	4108	4234	4356	4482	4598	4725	5304	5728	6142
4289 	45-Degree Unit with Shelf Public (Low Back) W 49 D 44 H 31 1/2 Seat Height 18 Inside Seat Width 18 - 36 1/2 Inside Seat Depth 22 1/2 5 Yds. 80 lbs. COL 100 Sq. Ft. TB 133, add \$240 List	3124	3408	3476	3597	3718	3833	3954	4064	4185	4736	5140	5534

OPTIONS (XXXX - REFERS TO CHAIR MODEL NUMBER)

MODEL	DESCRIPTION	LIST
XXXX-TAR03	Veneer/Laminate Rotating Tablet, Right (as seated)	383
XXXX-TAL03	Veneer/Laminate Rotating Tablet, Left (as seated)	383
XXXX-TAR03-CO	Corian Rotating Tablet, Right (as seated)	686
XXXX-TAL03-CO	Corian Rotating Tablet, Left (as seated)	686
XXXX-PB1-S, XXXX-PB1-W	Power Band 1 (1 Power, 1 Data), Silver or White	413
XXXX-PB2-S, XXXX-PB2-W	Power Band 2 (Dual Power), Silver or White	322
XXXX-PB3-S, XXXX-PB3-W	Power Band 3 (Dual Power, 2 USB), Silver or White	429
XXXX-NS01	Non-Skid Glides	20
XXXX-PF02	Premium Leg Finish	80
GC02 (order separately)	Ganging Connector	50

INTIMA MODULAR

designed by pld design group



NOTES:

- Manufactured in Beech hardwood.
- 300 lbs. maximum weight capacity.
- Footring available in Chrome only.

SPECIFY:

1. Model number
2. Wood finish
3. Upholstery selection, as applicable
4. Options, as applicable

ORDERING EXAMPLE:

#4270
Wood Seat Stool

SIN #711-18

MODEL NUMBER	PRODUCT SPECIFICATIONS	FABRIC GRADES						LEATHER GRADES					
		COM	1	2	COL 3	4	5	6	7	8	L1	L2	L3
4270	Stool, Wood Seat W 18 ¹ / ₄ D 18 ¹ / ₄ H 29 Seat Height 29 18 lbs.	638											
4275	Stool, Upholstered Seat W 18 ¹ / ₄ D 18 ¹ / ₄ H 30 ¹ / ₄ Seat Height 30 ¹ / ₄ 1/2 Yd. 16 lbs. COL 10 Sq. Ft. TB 133, add \$24 List	749	778	785	797	809	820	832	843	856	911	951	990

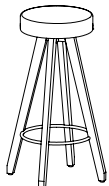
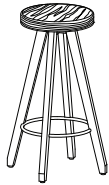

NOTES:

- Table top available in Maple, Walnut and White Oak veneer as well as laminate and Corian selections. Please refer to page 1 for details and edge finish specifications.
- For Corian tops, specify “-CO” next to model number and select color.
- Metal post and base plate available in standard and premium metal finishes, refer to page 1 for options.
- Base plate measures 16" in diameter.

SPECIFY:

1. Model number
2. Top wood species
3. Top finish
4. Base finish

ORDERING EXAMPLE:

#420-1627-PF02

Pull-Up Table
Premium Base Finish

INTIMA
MODULAR

designed by pld design group

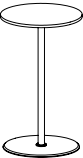

SIN #711-16

MODEL NUMBER	PRODUCT SPECIFICATIONS	TABLE TOP FINISH	
		VENEER OR LAMINATE	CORIAN (-CO)
420-1627 	Free-Standing Pull-Up Table Dimensions: 16" dia. x 27" high, 3/4" thickness 22 lbs.	819	1165

OPTIONS (XXXX - REFERS TO TABLE MODEL NUMBER)

MODEL	DESCRIPTION	LIST
XXXX-PF02	Premium Leg Finish	80

INTIMA MODULAR

designed by pld design group



SIN #711-16

CONFIGURATION AND ORDERING EXAMPLES

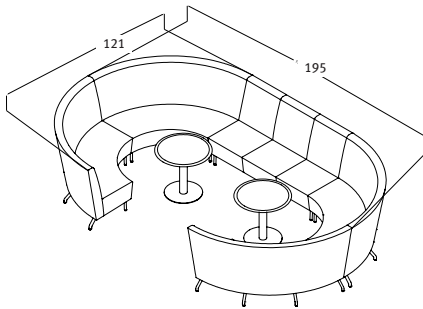

Qty	Model #	Description	COM List
4	4230	Quarter-Round Unit (\$3,723 each)	14,892
1	4233	Three-Seat Unit	3,175
2	HT-3629	Hush Meeting Table (\$2,201 each)	4,402
7			22,469

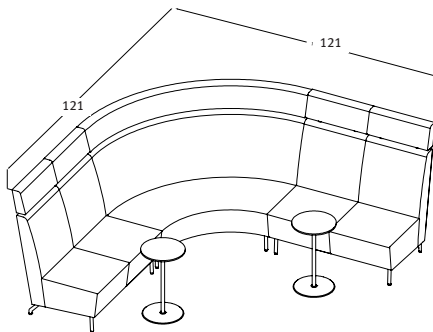

Qty	Model #	Description	COM List
2	4242	Two-Seat Unit with Headrest (\$2,504 each)	5,008
1	4240	Quarter-Round Unit with Headrest	4,176
2	420-1627	Free-Standing Pull-Up Table (\$819 each)	1,638
5			10,822

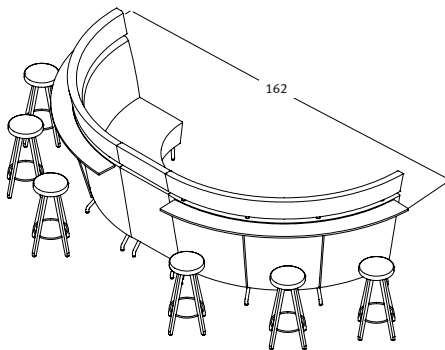

Qty	Model #	Description	COM List
2	4250	Quarter-Round Unit with Shelf & Headrest (\$5,309 each)	10,618
1	4241	Single-Seat Unit with Headrest	1,616
6	4270	Stool, Wood Seat (\$638 each)	3,828
9			16,062

UPHOLSTERY COMBINATIONS:

For fabric, vinyl or leather upholstery combinations, refer to the pricing below:

- When combining **two** COM/COV/COL fabrics, or fabrics with the same grade, add the following (per unit):
 - › \$65 List for single-seat, 45-degree and corner units
 - › \$105 List for two-seat units
 - › \$130 List for three-seat and quarter-round units
- When combining **three or more** COM/COV/COL fabrics, or fabrics with the same grade, add the following (per unit):
 - › \$75 List for single-seat, 45-degree and corner units
- › \$115 List for two-seat units
- › \$140 List for three-seat and quarter-round units.
- When combining different grades of fabric, price will be based on the highest grade specified.
- Two-tone upholstery examples and yardage requirements for the most common combinations are listed below. Additional combinations available, please contact Customer Service for yardage requirements and pricing.
- Note: Yardage amounts are based on fabric which is plain (i.e. non-directional) and a full 54" wide.
- **Appropriate upholstery code must be included on order.**

INTIMA MODULAR

designed by pld design group

SIN #711-16

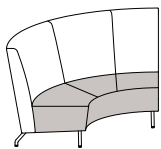

Code IM1
Model COM Requirement
4230 Seat Cushion Only = 2¹/₄ yds.
4260 Balance of Chair = 6¹/₂ yds.

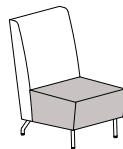

Code IM2
Model COM Requirement
4231 Seat Cushion Only = 1 yd.
Balance of Chair = 2¹/₄ yds.

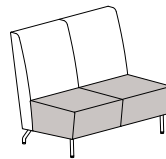

Code IM3
Model COM Requirement
4232 Seat Cushion Only = 1³/₄ yds.
4262 Balance of Chair = 3¹/₂ yds.

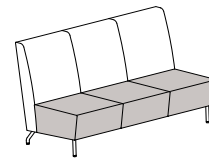

Code IM4
Model COM Requirement
4233 Seat Cushion Only = 2¹/₄ yds.
4263 Balance of Chair = 4¹/₂ yds.



Code IM5
Model COM Requirement
4281 Seat Cushion Only = 1¹/₂ yds.
4284 Balance of Chair = 2³/₄ yds.



Code IM6
Model COM Requirement
4234 Seat Cushion Only = 1¹/₄ yds.
Balance of Chair = 4¹/₄ yds.

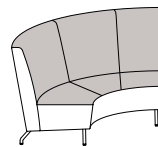

Code IM7
Model COM Requirement
4230 Inside Back & Top of Seat = 4¹/₂ yds.
4260 Balance of Chair = 4 yds.

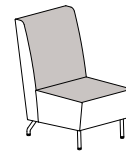

Code IM8
Model COM Requirement
4231 Inside Back & Top of Seat = 1¹/₄ yds.
Balance of Chair = 2¹/₄ yds.

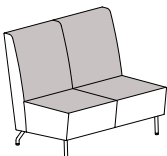

Code IM9
Model COM Requirement
4232 Inside Back & Top of Seat = 2 yds.
4262 Balance of Chair = 3 yds.

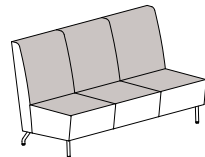

Code IM10
Model COM Requirement
4233 Inside Back & Top of Seat = 2³/₄ yds.
4263 Balance of Chair = 4 yds.



Code IM11
Model COM Requirement
4281 Inside Back & Top of Seat = 1³/₄ yds.
4284 Balance of Chair = 2¹/₂ yds.

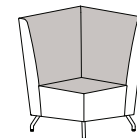

Code IM12
Model COM Requirement
4234 Inside Back & Top of Seat = 2¹/₄ yds.
Balance of Chair = 3 yds.

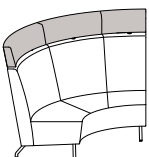

Code IM13
Model COM Requirement
4240 Headrest Only = 2³/₄ yds.
4250 Balance of Chair = 8¹/₂ yds.

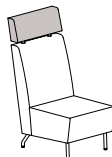

Code IM14
Model COM Requirement
4241 Headrest Only = 3¹/₄ yd.
Balance of Chair = 3¹/₄ yds.

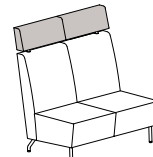

Code IM15
Model COM Requirement
4242 Headrest Only = 1¹/₄ yds.
4252 Balance of Chair = 4³/₄ yds.

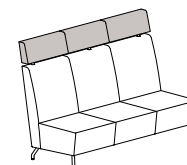

Code IM16
Model COM Requirement
4243 Headrest Only = 1³/₄ yds.
4253 Balance of Chair = 6³/₄ yds.

INTIMA MODULAR

designed by pld design group

UPHOLSTERY COMBINATIONS:

For fabric, vinyl or leather upholstery combinations, refer to the pricing below:

- When combining **two** COM/COV/COL fabrics, or fabrics with the same grade, add the following (per unit):
 - › \$65 List for single-seat, 45-degree and corner units
 - › \$105 List for two-seat units
 - › \$130 List for three-seat and quarter-round units
- When combining **three or more** COM/COV/COL fabrics, or fabrics with the same grade, add the following (per unit):
 - › \$75 List for single-seat, 45-degree and corner units

- › \$115 List for two-seat units
- › \$140 List for three-seat and quarter-round units.

- When combining different grades of fabric, price will be based on the highest grade specified.
- Two-tone upholstery examples and yardage requirements for the most common combinations are listed below. Additional combinations available, please contact Customer Service for yardage requirements and pricing.
- Note: Yardage amounts are based on fabric which is plain (i.e. non-directional) and a full 54" wide.
- **Appropriate upholstery code must be included on order.**

SIN #711-16

CONFIGURATION AND ORDERING EXAMPLES

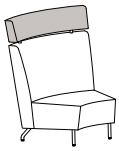

Code IM17

Model COM Requirement
4282 Headrest Only = $3\frac{3}{4}$ yd.
4283 Balance of Chair = $3\frac{3}{4}$ yds.

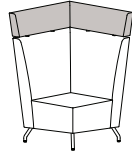

Code IM18

Model COM Requirement
4244 Headrest Only = $1\frac{3}{4}$ yds.
Balance of Chair = $4\frac{1}{4}$ yds.

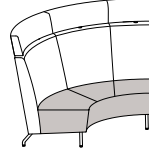

Code IM19

Model COM Requirement
4240 Seat Cushion Only = $2\frac{1}{4}$ yds.
4250 Balance of Chair = 9 yds.



Code IM20

Model COM Requirement
4241 Seat Cushion Only = 1 yd.
Balance of Chair = $2\frac{3}{4}$ yds.



Code IM21

Model COM Requirement
4242 Seat Cushion Only = $1\frac{3}{4}$ yds.
4252 Balance of Chair = $4\frac{1}{4}$ yds.



Code IM22

Model COM Requirement
4243 Seat Cushion Only = $2\frac{1}{4}$ yds.
4253 Balance of Chair = $6\frac{1}{4}$ yds.

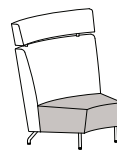

Code IM23

Model COM Requirement
4282 Seat Cushion Only = $1\frac{1}{2}$ yds.
4283 Balance of Chair = $3\frac{1}{2}$ yds.

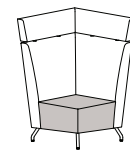

Code IM24

Model COM Requirement
4244 Seat Cushion Only = $1\frac{1}{4}$ yds.
Balance of Chair = $5\frac{3}{4}$ yds.

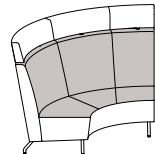

Code IM25

Model COM Requirement
4240 Inside Back & Top
4250 of Seat = $4\frac{3}{4}$ yds.
Balance of Chair = $6\frac{1}{2}$ yds.

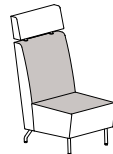

Code IM26

Model COM Requirement
4241 Inside Back & Top
4281 of Seat = $1\frac{1}{4}$ yds.
Balance of Chair = $2\frac{3}{4}$ yds.

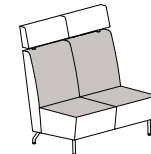

Code IM27

Model COM Requirement
4242 Inside Back & Top
4252 of Seat = 2 yds.
Balance of Chair = $3\frac{3}{4}$ yds.

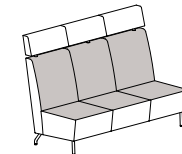

Code IM28

Model COM Requirement
4243 Inside Back & Top
4253 of Seat = 3 yds.
Balance of Chair = 5 yds.

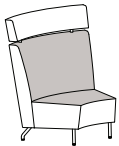

Code IM29

Model COM Requirement
4282 Inside Back & Top
4283 of Seat = $1\frac{3}{4}$ yds.
Balance of Chair = $3\frac{1}{4}$ yds.



Code IM30

Model COM Requirement
4244 Inside Back & Top
4244 of Seat = $2\frac{1}{4}$ yds.
Balance of Chair = $4\frac{1}{2}$ yds.

UPHOLSTERY COMBINATIONS:

For fabric, vinyl or leather upholstery combinations, refer to the pricing below:

- When combining **two** COM/COV/COL fabrics, or fabrics with the same grade, add the following (per unit):
 - › \$65 List for single-seat, 45-degree and corner units
 - › \$105 List for two-seat units
 - › \$130 List for three-seat and quarter-round units
- When combining **three or more** COM/COV/COL fabrics, or fabrics with the same grade, add the following (per unit):
 - › \$75 List for single-seat, 45-degree and corner units

- › \$115 List for two-seat units
- › \$140 List for three-seat and quarter-round units.

- When combining different grades of fabric, price will be based on the highest grade specified.
- Two-tone upholstery examples and yardage requirements for the most common combinations are listed below. Additional combinations available, please contact Customer Service for yardage requirements and pricing.
- Note: Yardage amounts are based on fabric which is plain (i.e. non-directional) and a full 54" wide.
- **Appropriate upholstery code must be included on order.**

INTIMA MODULAR

designed by pld design group

SIN #711-16

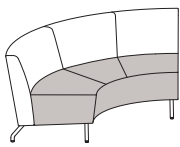

Code IM31
Model COM Requirement
4235 Seat Cushion Only = 2¹/₄ yds.
4265 Balance of Chair = 4³/₄ yds.



Code IM32
Model COM Requirement
4236 Seat Cushion Only = 1 yd.
Balance of Chair = 1³/₄ yds.

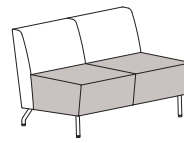

Code IM33
Model COM Requirement
4237 Seat Cushion Only = 1¹/₂ yds.
4267 Balance of Chair = 2¹/₂ yds.

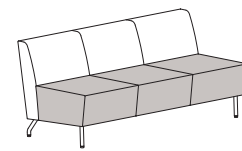

Code IM34
Model COM Requirement
4238 Seat Cushion Only = 2¹/₄ yds.
4268 Balance of Chair = 3 yds.

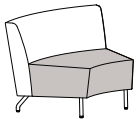

Code IM35
Model COM Requirement
4286 Seat Cushion Only = 1¹/₂ yds.
4289 Balance of Chair = 2³/₄ yds.



Code IM36
Model COM Requirement
4239 Seat Cushion Only = 1¹/₄ yds.
Balance of Chair = 2¹/₂ yds.

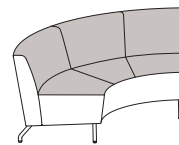

Code IM37
Model COM Requirement
4235 Inside Back & Top of Seat = 2³/₄ yds.
4265 Balance of Chair = 3¹/₄ yds.



Code IM38
Model COM Requirement
4236 Inside Back & Top of Seat = 1 yd.
Balance of Chair = 1³/₄ yds.



Code IM39
Model COM Requirement
4237 Inside Back & Top of Seat = 1³/₄ yds.
Balance of Chair = 2¹/₄ yds.

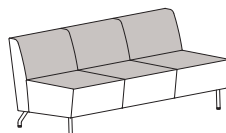

Code IM40
Model COM Requirement
4238 Inside Back & Top of Seat = 2¹/₂ yds.
4268 Balance of Chair = 3¹/₄ yds.



Code IM41
Model COM Requirement
4286 Inside Back & Top of Seat = 1³/₄ yds.
4289 Balance of Chair = 2¹/₂ yds.

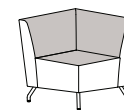

Code IM42
Model COM Requirement
4239 Inside Back & Top of Seat = 1¹/₂ yds.
Balance of Chair = 2¹/₂ yds.

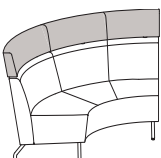

Code IM43
Model COM Requirement
4245 Headrest Only = 2¹/₄ yds.
4255 Balance of Chair = 5³/₄ yds.



Code IM44
Model COM Requirement
4246 Headrest Only = 3³/₄ yd.
Balance of Chair = 2¹/₄ yds.



Code IM45
Model COM Requirement
4247 Headrest Only = 1¹/₄ yds.
4257 Balance of Chair = 3³/₄ yds.

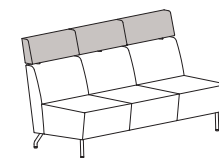

Code IM46
Model COM Requirement
4248 Headrest Only = 1³/₄ yds.
4258 Balance of Chair = 5 yds.

INTIMA MODULAR

designed by pld design group

UPHOLSTERY COMBINATIONS:

For fabric, vinyl or leather upholstery combinations, refer to the pricing below:

- When combining **two** COM/COV/COL fabrics, or fabrics with the same grade, add the following (per unit):
 - › \$65 List for single-seat, 45-degree and corner units
 - › \$105 List for two-seat units
 - › \$130 List for three-seat and quarter-round units
- When combining **three or more** COM/COV/COL fabrics, or fabrics with the same grade, add the following (per unit):
 - › \$75 List for single-seat, 45-degree and corner units

- › \$115 List for two-seat units
- › \$140 List for three-seat and quarter-round units.

- When combining different grades of fabric, price will be based on the highest grade specified.
- Two-tone upholstery examples and yardage requirements for the most common combinations are listed below. Additional combinations available, please contact Customer Service for yardage requirements and pricing.
- Note: Yardage amounts are based on fabric which is plain (i.e. non-directional) and a full 54" wide.
- **Appropriate upholstery code must be included on order.**

SIN #711-16

CONFIGURATION AND ORDERING EXAMPLES



Code IM47

Model COM Requirement
4287 Headrest Only = $3\frac{3}{4}$ yd.
4288 Balance of Chair = $3\frac{3}{4}$ yds.



Code IM48

Model COM Requirement
4249 Headrest Only = $1\frac{3}{4}$ yds.
Balance of Chair = $4\frac{3}{4}$ yds.

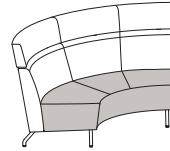

Code IM49

Model COM Requirement
4245 Seat Cushion Only = $2\frac{1}{4}$ yds.
4255 Balance of Chair = 6 yds.



Code IM50

Model COM Requirement
4246 Seat Cushion Only = 1 yd.
Balance of Chair = 2 yds.

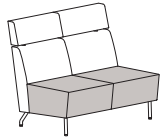

Code IM51

Model COM Requirement
4247 Seat Cushion Only = $1\frac{1}{2}$ yds.
4257 Balance of Chair = $3\frac{1}{2}$ yds.

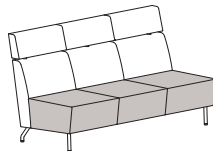

Code IM52

Model COM Requirement
4248 Seat Cushion Only = $2\frac{1}{4}$ yds.
4258 Balance of Chair = $4\frac{1}{4}$ yds.



Code IM53

Model COM Requirement
4287 Seat Cushion Only = $1\frac{1}{2}$ yds.
4288 Balance of Chair = $3\frac{1}{2}$ yds.



Code IM54

Model COM Requirement
4249 Seat Cushion Only = 1 yd.
Balance of Chair = 4 yds.

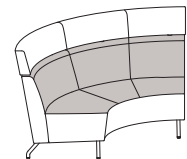

Code IM55

Model COM Requirement
4245 Inside Back &
4255 Top of Seat = $2\frac{3}{4}$ yds.
Balance of Chair = $5\frac{1}{4}$ yds.



Code IM56

Model COM Requirement
4246 Inside Back & Top
of Seat = 1 yd.
Balance of Chair = 2 yds.



Code IM57

Model COM Requirement
4247 Inside Back & Top
of Seat = $1\frac{3}{4}$ yds.
4257 Balance of Chair = $3\frac{1}{2}$ yds.

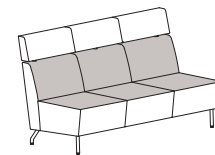

Code IM58

Model COM Requirement
4248 Inside Back & Top
of Seat = $2\frac{1}{2}$ yds.
4258 Balance of Chair = $4\frac{1}{4}$ yds.



Code IM59

Model COM Requirement
4287 Inside Back & Top
of Seat = $1\frac{3}{4}$ yds.
4288 Balance of Chair = $3\frac{1}{4}$ yds.



Code IM60

Model COM Requirement
4249 Inside Back & Top
of Seat = $1\frac{1}{2}$ yds.
Balance of Chair = 4 yds.

LEAF BENCHES

designed by david dahl



SIN #711-16

BENCH PRODUCT FEATURES:

- Units available individually or in modular combinations with lounge and full size bench models as well as connecting tables (not ganged).
- For modular arrangements utilizing shared legs, please refer to models on page 4.
- Each unit comes standard with four (4) 5¹/₂" high Beech wood or metal legs.
- All standard and custom wood finishes available on Beech.
- For custom finishes (to legs and/or tables), please add one-time upcharge of \$400 List per color per order.
- Metal legs available in #92 Polished Aluminum and the following powdercoat finishes: #06 Charcoal Grey and #90 Metallic Silver.
- Maximum weight capacity is 750 lbs.
- Non-skid glides available for hard surface floors. Please specify "-NS02B" after model number and add \$20 List per unit.
- Two-tone upholstery examples and yardage requirements featured on page 6.
- **Note: For modular configurations, please include layout drawings or sketch with each order.**
- All dimensions are nominal.

TABLE PRODUCT FEATURES:

- Tables manufactured in Maple, Walnut and White Oak.
- All standard and custom wood finishes available.
- For custom finishes (to legs and/or tables), please add one-time upcharge of \$400 List per color per order.
- Laminate and Corian tops available (veneer body as standard, finish must be specified).
- For Corian tops, specify "-CO" next to model number and select color. Corian top is affixed to table surface increasing overall table height by ¹/₂". Please note that a ¹/₈" reveal will be present.
- Each unit comes standard with four (4) 5¹/₂" high Beech wood or metal legs.
- Metal legs available in #92 Polished Aluminum and the following powdercoat finishes: #06 Charcoal Grey and #90 Metallic Silver.
- Non-skid glides available for hard surface floors. Please specify "-NS02B" after model number and add \$20 List per unit.
- Tables connect with all lounge, bench and mid-size bench models as well as Leaflette children's lounge and bench units.
- For modular arrangements utilizing shared legs, please refer to models on page 5.
- All dimensions are nominal.

CORIAN® COLORS:

Designer White
Linen
Rain Cloud
Witch Hazel

Corian® is a registered trademark of Dupont.

LEAF BENCHES

designed by david dahl



NOTES:

- Units available individually or in modular combinations.
- For modular arrangements utilizing shared legs, please refer to models on page 4.
- Each unit comes standard with four (4) 5¹/₂" high Beech wood or metal legs.
- Refer to page 6 for two-tone upholstery examples and yardage requirements.



SPECIFY:

1. Model number
2. Leg finish
3. Upholstery selection
4. Options, as applicable

ORDERING EXAMPLE:

#3710-NS02B
Mid-Size Bench
Non-Skid Glides

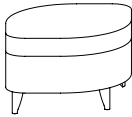
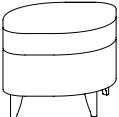
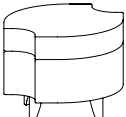
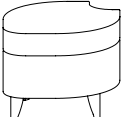
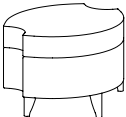
SIN #711-16

MODEL NUMBER	PRODUCT SPECIFICATIONS	FABRIC GRADES								LEATHER GRADES						
		COM	1	2	COL			4	5	6	7	8	L1	L2	L3	
3705 	Full Size Bench W 37 D 27 ¹ / ₄ H 18 ¹ / ₂ Seat Height 18 ¹ / ₂ 2 Yds. 30 lbs. COL 40 Sq. Ft. TB 133, add \$96 List	1037	1151	1178	1226	1275	1321	1369	1413	1462	1682	1844	2001			
3710 	Mid-Size Bench W 28 ¹ / ₄ D 21 ¹ / ₂ H 18 ¹ / ₂ Seat Height 18 ¹ / ₂ 1 ³ / ₄ Yds. 28 lbs. COL 35 Sq. Ft. TB 133, add \$84 List	986	1086	1110	1152	1194	1235	1277	1315	1358	1551	1692	1830			
3715 	Mid-Size In-Line Bench W 23 ¹ / ₂ D 21 ¹ / ₂ H 18 ¹ / ₂ Seat Height 18 ¹ / ₂ 1 ³ / ₄ Yds. 27 lbs. COL 35 Sq. Ft. TB 133, add \$84 List	959	1059	1083	1125	1167	1208	1250	1288	1331	1524	1665	1803			
3720 	Mid-Size In-Line/End Bench W 26 D 21 ¹ / ₂ H 18 ¹ / ₂ Seat Height 18 ¹ / ₂ 1 ³ / ₄ Yds. 27 lbs. COL 35 Sq. Ft. TB 133, add \$84 List	937	1037	1061	1103	1145	1186	1228	1266	1309	1502	1643	1781			
3730 	Mid-Size 30-Degree Bench W 27 ¹ / ₄ D 21 ¹ / ₂ H 18 ¹ / ₂ Seat Height 18 ¹ / ₂ 1 ¹ / ₂ Yds. 27 lbs. COL 30 Sq. Ft. TB 133, add \$72 List	937	1023	1043	1079	1115	1150	1186	1219	1256	1421	1542	1660			
3745 	Mid-Size 45-Degree Bench W 28 D 22 H 18 ¹ / ₂ Seat Height 18 ¹ / ₂ 1 ¹ / ₂ Yds. 27 lbs. COL 30 Sq. Ft. TB 133, add \$72 List	937	1023	1043	1079	1115	1150	1186	1219	1256	1421	1542	1660			

OPTIONS (XXXX - REFERS TO BENCH MODEL NUMBER)

MODEL	DESCRIPTION	LIST
XXXX-NS02B	Non-Skid Glides	20

NOTES:

- Tables manufactured in Maple, Walnut and White Oak.
- For Corian tops, specify “-CO” next to model number and select color. Corian top is affixed to table surface increasing overall table height by 1/2" and features 1/8" reveal.
- Each unit comes standard with four (4) 5 1/2" high Beech wood or metal legs.
- Tables connect with all lounge, bench and mid-size bench models as well as Leaflette lounge and bench units.
- For modular arrangements utilizing shared legs, please refer to page 5.

SPECIFY:

1. Model number
2. Wood species
3. Wood finish
4. Leg finish
5. Options, as applicable

ORDERING EXAMPLE:





#3750-30-NS02B
30-Degree Table
Non-Skid Glides

LEAF BENCHES

designed by david dahl

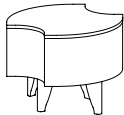
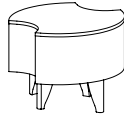

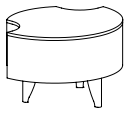
SIN #711-16

MODEL NUMBER	PRODUCT SPECIFICATIONS	TABLE TOP FINISHES	
		VENEER OR LAMINATE	CORIAN (-CO)
3750 	In-Line Table W 16 ³ / ₄ D 16 ¹ / ₂ H 13 ¹ / ₄ 15 lbs.	928	1362
3750-30 	30-Degree Table W 18 ¹ / ₄ D 16 ¹ / ₂ H 13 ¹ / ₄ 15 lbs.	920	1355
3750-45 	45-Degree Table W 19 D 16 ³ / ₄ H 13 ¹ / ₄ 15 lbs.	928	1362
3750-90 	90-Degree Table W 23 D 19 H 13 ¹ / ₄ 15 lbs.	997	1623
3755 	In-Line/End Table W 19 D 16 ¹ / ₂ H 13 ¹ / ₄ 15 lbs.	937	1907

OPTIONS (XXXX - REFERS TO TABLE MODEL NUMBER)

MODEL	DESCRIPTION	LIST
XXXX-NS02B	Non-Skid Glides	20

LEAF BENCHES

designed by david dahl



NOTES:

- Models feature a shared ganging leg (-G) to connect units together.
- For stand-alone units (without ganging connector), please refer to models on page 2.
- Each unit comes standard with four (4) 5¹/₂" high Beech wood or metal legs.

SPECIFY:



1. Model number
2. Wood platform finish
3. Leg finish
4. Upholstery selection
5. Options, as applicable

ORDERING EXAMPLE:

#3720-G-NS02B

Mid-Size In-Line/End Bench
Non-Skid Glides

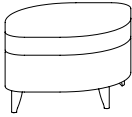
SIN #711-16

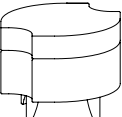
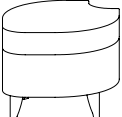
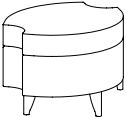
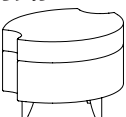
MODEL NUMBER	PRODUCT SPECIFICATIONS	FABRIC GRADES							LEATHER GRADES				
		COM	1	2	COL			8	L1	L2	L3		
3705-G 	Full Size Bench, Ganging W 37 D 27 ¹ / ₄ H 18 ¹ / ₂ Seat Height 18 ¹ / ₂ 2 Yds. 30 lbs. COL 40 Sq. Ft. TB 133, add \$96 List	1097	1211	1238	1286	1335	1381	1429	1473	1522	1742	1904	2061
3710-G 	Mid-Size Bench, Ganging W 28 ¹ / ₄ D 21 ¹ / ₂ H 18 ¹ / ₂ Seat Height 18 ¹ / ₂ 1 ³ / ₄ Yds. 28 lbs. COL 35 Sq. Ft. TB 133, add \$84 List	1044	1144	1168	1210	1252	1293	1335	1373	1416	1609	1750	1888
3715-G 	Mid-Size In-Line Bench, Ganging W 23 ¹ / ₂ D 21 ¹ / ₂ H 18 ¹ / ₂ Seat Height 18 ¹ / ₂ 1 ³ / ₄ Yds. 27 lbs. COL 35 Sq. Ft. TB 133, add \$84 List	1018	1118	1142	1184	1226	1267	1309	1347	1390	1583	1724	1862
3720-G 	Mid-Size In-Line/End Bench, Ganging W 26 D 21 ¹ / ₂ H 18 ¹ / ₂ Seat Height 18 ¹ / ₂ 1 ³ / ₄ Yds. 27 lbs. COL 35 Sq. Ft. TB 133, add \$84 List	996	1096	1120	1162	1204	1245	1287	1325	1368	1561	1702	1840
3730-G 	Mid-Size 30-Degree Bench, Ganging W 27 ¹ / ₄ D 21 ¹ / ₂ H 18 ¹ / ₂ Seat Height 18 ¹ / ₂ 1 ¹ / ₂ Yds. 27 lbs. COL 30 Sq. Ft. TB 133, add \$72 List	996	1082	1102	1138	1174	1209	1245	1278	1315	1480	1601	1719
3745-G 	Mid-Size 45-Degree Bench, Ganging W 28 D 22 H 18 ¹ / ₂ Seat Height 18 ¹ / ₂ 1 ¹ / ₂ Yds. 27 lbs. COL 30 Sq. Ft. TB 133, add \$72 List	996	1082	1102	1138	1174	1209	1245	1278	1315	1480	1601	1719

OPTIONS (XXXX - REFERS TO BENCH MODEL NUMBER)

MODEL	DESCRIPTION	LIST
XXXX-NS02B	Non-Skid Glides	20

NOTES:

- Models feature a shared ganging leg (-G) to connect units together.
- Tables manufactured in Maple, Walnut and White Oak.
- For Corian tops, specify “-CO” next to model number and select color. Corian top is affixed to table surface increasing overall table height by 1/2" and features 1/8" reveal.
- Each unit comes standard with four (4) 5 1/2" high Beech wood or metal legs.
- Tables connect with all lounge, bench and mid-size bench models as well as Leaflette lounge and bench units.

SPECIFY:

1. Model number
2. Wood species
3. Wood finish
4. Leg finish
5. Options, as applicable

ORDERING EXAMPLE:



#3750-G-NS02B
 In-Line Table
 Non-Skid Glides

LEAF BENCHES

designed by david dahl

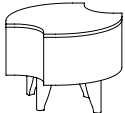
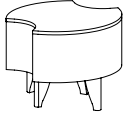
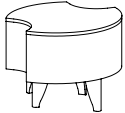

SIN #711-16

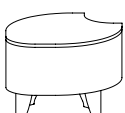
MODEL NUMBER	PRODUCT SPECIFICATIONS	TABLE TOP FINISHES	
		VENEER OR LAMINATE	CORIAN (-CO)
3750-G 	In-Line Table, Ganging W 16 ³ / ₄ D 16 ¹ / ₂ H 13 ¹ / ₄ 15 lbs.	987	1424
3750-30-G 	30-Degree Table, Ganging W 18 ¹ / ₄ D 16 ¹ / ₂ H 13 ¹ / ₄ 15 lbs.	979	1414
3750-45-G 	45-Degree Table, Ganging W 19 D 16 ³ / ₄ H 13 ¹ / ₄ 15 lbs.	987	1424
3750-90-G 	90-Degree Table, Ganging W 23 D 19 H 13 ¹ / ₄ 15 lbs.	1056	1680
3755-G 	In-Line/End Table, Ganging W 19 D 16 ¹ / ₂ H 13 ¹ / ₄ 15 lbs.	996	1966

OPTIONS (XXXX - REFERS TO TABLE MODEL NUMBER)

MODEL	DESCRIPTION	LIST
XXXX-NS02B	Non-Skid Glides	20

LEAF BENCHES

designed by david dahl



UPHOLSTERY COMBINATIONS:

For fabric, vinyl or leather upholstery combinations, refer to the pricing below:

- When combining **two** COM/COV/COL fabrics, or fabrics with the same grade, price will be \$65 List (per unit).
 - When combining **three or more** COM/COV/COL fabrics, or fabrics with the same grade, price will be \$75 List (per unit).
 - When combining different grades of fabric, price will be based on the highest grade specified.
- Two-tone upholstery examples and yardage requirements for the most common combinations are listed below. Additional combinations available, please contact Customer Service for yardage requirements and pricing.
 - Note: Yardage amounts are based on fabric which is plain (i.e. non-directional) and a full 54" wide.
 - **Appropriate upholstery code must be included on order.**

SIN #711-16

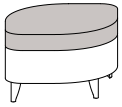

Code LM4

Model COM Requirement
 3705 Seat Cushion = 1¹/₄ yds.
 3705-G Seat Box = ³/₄ yd.

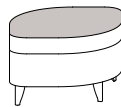

Code LM5

Model COM Requirement
 3705 Top of Seat Only = 1 yd.
 3705-G Balance of Bench = 1 yd.

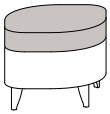

Code LM6

Model COM Requirement
 3710 Seat Cushion = 1¹/₄ yds.
 3710-G Seat Box = ³/₄ yd.

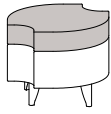

Code LM7

Model COM Requirement
 3715 Seat Cushion = 1¹/₄ yds.
 3715-G Seat Box = ³/₄ yd.



Code LM8

Model COM Requirement
 3720 Seat Cushion = 1¹/₄ yds.
 3720-G Seat Box = ³/₄ yd.

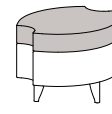

Code LM9

Model COM Requirement
 3730 Seat Cushion = 1¹/₄ yds.
 3730-G Seat Box = ³/₄ yd.



Code LM10

Model COM Requirement
 3745 Seat Cushion = 1¹/₄ yds.
 3745-G Seat Box = ³/₄ yd.



Code LM11

Model COM Requirement
 3710 Top of Seat Only = ³/₄ yd.
 3710-G Balance of Bench = 1¹/₄ yds.

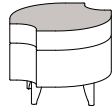

Code LM12

Model COM Requirement
 3715 Top of Seat Only = ³/₄ yd.
 3715-G Balance of Bench = 1¹/₄ yds.



Code LM13

Model COM Requirement
 3720 Top of Seat Only = ³/₄ yd.
 3720-G Balance of Bench = 1¹/₄ yds.



Code LM14

Model COM Requirement
 3730 Top of Seat Only = ³/₄ yd.
 3730-G Balance of Bench = 1¹/₄ yds.



Code LM15

Model COM Requirement
 3745 Top of Seat Only = ³/₄ yd.
 3745-G Balance of Bench = 1¹/₄ yds.

LEAF LOUNGE

designed by david dahl



SIN #711-16

PRODUCT FEATURES:

- Fixed seat cushion.
- Available with optional clean-out feature between seat and back for maintenance ease (model number designated with a -V).
- Maximum weight capacity of 750 lbs. for lounge chair and 1000 lbs. for love seat.
- Each unit comes standard with four (4) 5¹/₂" high Beech wood or metal legs.
- All standard and custom wood finishes available on Beech.
- For custom finishes (to legs and/or rotating tablet), please add one-time upcharge of \$400 List per color per order.
- Metal legs available in #92 Polished Aluminum and the following finishes: #06 Charcoal Grey and #90 Metallic Silver.
- Non-skid glides available for hard surface floors. Please specify “-NS02B” after model number and add \$20 List per chair.
- Please refer to page 3 for two-tone upholstery examples, yardage requirements and pricing.
- All dimensions are nominal.

ROTATING TABLET:

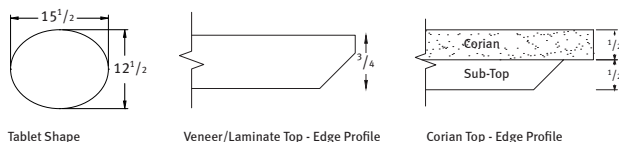

Tablet Shape

Veneer/Laminate Top - Edge Profile

Corian Top - Edge Profile

- Tablet is affixed to right or left arm/side, as specified.
- Tablet size is 15¹/₂" W x 12¹/₂" D x 3/4" thick with 360-degree turning radius.
- Three tablet surface options: veneer, laminate and Corian.
- Veneer offered in Maple, Walnut and White Oak, in all standard and custom wood finishes.
- For custom finishes (to legs and/or rotating tablet), please add one-time upcharge of \$400 List per color per order.
- Laminate is applied to tablet top surface only.
- For standard laminates, refer to Standard Finish Card.
- For custom laminates, add \$500 List per color per order. Pre-approval required, please contact Customer Service.
- Corian available in four standard colors. For non-standard options, please contact Customer Service for pricing.
- For maximum durability, a laminate or Corian surface with a clear coat edge finish is recommended.
- Tablet mounting post available in #91 Chrome and the following finishes: #06 Charcoal Grey and #90 Metallic Silver.
- Tablet mounting post will match leg finish unless otherwise specified. For legs finished in #92 Polished Aluminum, tablet mounting post will be #91 Chrome as standard.

TABLET EDGE FINISH SPECIFICATIONS:

- For veneer tops, edge finish will always match the top finish color, unless otherwise specified.
- For standard laminate tops (laminate cannot be applied to the edge):
 - › Wood grain laminates, edge finish will match the laminate top color, unless otherwise specified.
 - › Solid color laminates, edge finish will be natural (clear coat) as standard, unless otherwise specified.
- For Corian tops:
 - › Designer White, Rain Cloud and Linen colors, edge will be white as standard, unless otherwise specified.
 - › Witch Hazel, edge will be natural (clear coat) as standard, unless otherwise specified.
- Edges are also available in all standard wood finishes, please specify. For custom edge finishes, please add one-time upcharge of \$400 List per color, per order.

LEAF LOUNGE

designed by david dahl



NOTES:

- Models designated with a -V feature clean-out between seat and back for maintenance ease.
- Each unit comes standard with four (4) 5¹/₂" high Beech wood or metal legs.
- Refer to page 3 for two-tone upholstery examples and yardage requirements.

SPECIFY:

- Model number
- Leg finish
- Upholstery selection
- Options, as applicable

ORDERING EXAMPLE:

#3700-TAR03-NS02B
Lounge Chair
Veneer Tablet, Right
Non-Skid Glides

SIN #711-16

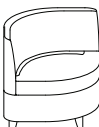
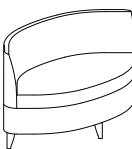
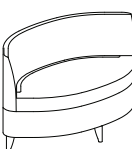
MODEL NUMBER	PRODUCT SPECIFICATIONS	FABRIC GRADES							LEATHER GRADES				
		COM	1	2	COL			8	L1	L2	L3		
3700 	Lounge Chair W 37 D 27 ¹ / ₄ H 31 Seat Height 18 ¹ / ₂ Inside Seat Width 33 Inside Seat Depth 22 3 Yds. 45 lbs. COL 60 Sq. Ft. TB 133, add \$144 List	1286	1457	1498	1570	1642	1712	1784	1850	1923	2254	2496	2732
3700-V 	Lounge Chair with Clean-Out W 37 D 27 ¹ / ₄ H 31 Seat Height 18 ¹ / ₂ Inside Seat Width 33 Inside Seat Depth 23 ¹ / ₄ 3 ³ / ₄ Yds. 45 lbs. COL 75 Sq. Ft. TB 133, add \$180 List	1374	1587	1638	1729	1819	1906	1997	2079	2170	2583	2886	3182
3702 	Love Seat W 55 D 29 ¹ / ₄ H 31 Seat Height 18 ¹ / ₂ Inside Seat Width 48 Inside Seat Depth 22 5 Yds. 55 lbs. COL 100 Sq. Ft. TB 133, add \$240 List	1805	2089	2157	2278	2399	2514	2635	2745	2866	3417	3821	4215
3702-V 	Love Seat with Clean-Out W 55 D 29 ¹ / ₄ H 31 Seat Height 18 ¹ / ₂ Inside Seat Width 48 Inside Seat Depth 23 ¹ / ₄ 5 ¹ / ₂ Yds. 55 lbs. COL 110 Sq. Ft. TB 133, add \$264 List	1980	2292	2367	2500	2633	2760	2893	3014	3147	3753	4198	4631

OPTIONS (XXXX - REFERS TO CHAIR MODEL NUMBER)

MODEL	DESCRIPTION	LIST
XXXX-TAR03	Veneer/Laminate Rotating Tablet, Right (as seated)	383
XXXX-TAL03	Veneer/Laminate Rotating Tablet, Left (as seated)	383
XXXX-TAR03-CO	Corian Rotating Tablet, Right (as seated)	686
XXXX-TAL03-CO	Corian Rotating Tablet, Left (as seated)	686
XXXX-MB02	Moisture Barrier, Lounge Chair (with or without clean-out)	95
XXXX-MB03	Moisture Barrier, Love Seat (with or without clean-Out)	145
XXXX-NS02B	Non-Skid Glides	20

UPHOLSTERY COMBINATIONS:

For fabric, vinyl or leather upholstery combinations, refer to the pricing below:

- When combining **two** COM/COV/COL fabrics, or fabrics with the same grade, add the following (per unit):
 - › \$65 List for lounge chairs
 - › \$105 List for love seats
- When combining **three or more** COM/COV/COL fabrics, or fabrics with the same grade, add the following (per unit):
 - › \$75 List for lounge chairs
 - › \$115 List for love seats

- When combining different grades of fabric, price will be based on the highest grade specified.
- Two-tone upholstery examples and yardage requirements for the most common combinations are listed below. Additional combinations available, please contact Customer Service for yardage requirements and pricing.
- Note: Yardage amounts are based on fabric which is plain (i.e. non-directional) and a full 54" wide.
- **Appropriate upholstery code must be included on order.**

LEAF LOUNGE

designed by david dahl



SIN #711-16

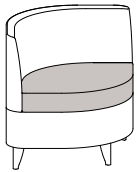

Code LM1

Model COM Requirement
3700 Seat Cushion Only = 1 yd.
Balance of Chair = 2¹/₂ yds.

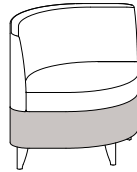

Code LM2

Model COM Requirement
3700 Seat Box Only = 3³/₄ yd.
Balance of Chair = 2¹/₂ yds.

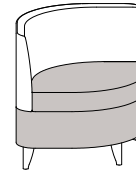

Code LM3

Model COM Requirement
3700 Seat Cushion & Seat Box = 1³/₄ yds.
Balance of Chair = 1³/₄ yds.

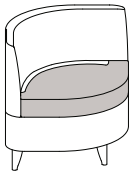

Code LM4

Models COM Requirement
3700-V Seat Cushion Only = 1 yd.
Balance of Chair = 2³/₄ yds.

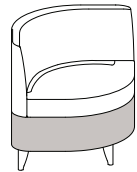

Code LM5

Models COM Requirement
3700-V Seat Box Only = 3³/₄ yd.
Balance of Chair = 3 yds.

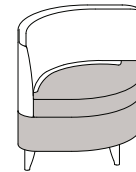

Code LM6

Models COM Requirement
3700-V Seat Cushion & Seat Box = 2 yds.
Balance of Chair = 2¹/₄ yds.

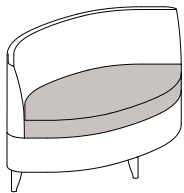

Code LM7

Models COM Requirement
3702 Seat Cushion Only = 1¹/₂ yds.
Balance of Love Seat = 3¹/₂ yds.

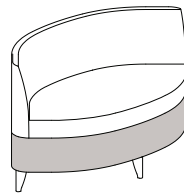

Code LM8

Models COM Requirement
3702 Seat Box Only = 1¹/₂ yds.
Balance of Love Seat = 3¹/₂ yds.

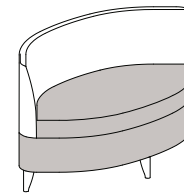

Code LM9

Models COM Requirement
3702 Seat Cushion & Seat Box = 3 yds.
Balance of Love Seat = 2¹/₂ yds.

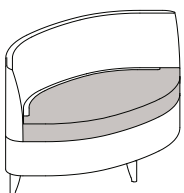

Code LM10

Models COM Requirement
3702-V Seat Cushion Only = 2 yds.
Balance of Love Seat = 3³/₄ yds.

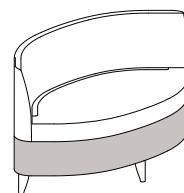

Code LM11

Models COM Requirement
3702-V Seat Box Only = 1¹/₂ yds.
Balance of Love Seat = 4¹/₄ yds.

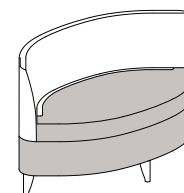

Code LM12

Models COM Requirement
3702-V Seat Cushion & Seat Box = 3¹/₄ yds.
Balance of Love Seat = 2³/₄ yds.

LEAF MODULAR

designed by david dahl

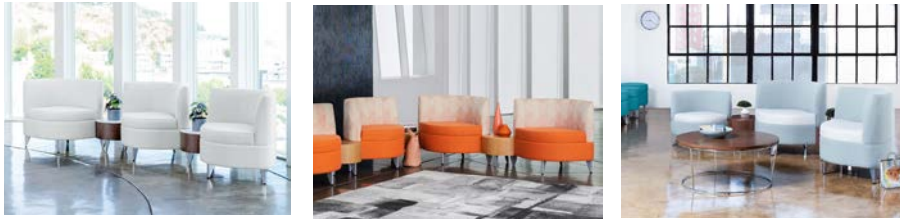

SIN #711-16

LOUNGE AND LOVE SEAT PRODUCT FEATURES:

- Fixed seat cushion.
- Available with optional clean-out feature between seat and back for maintenance ease (model number designated with a -V).
- Maximum weight capacity of 750 lbs. for lounge chair and 1000 lbs. for love seat.
- Each unit comes standard with four (4) 5¹/₂" high Beech wood or metal legs.
- All standard and custom wood finishes available on Beech.
- For custom finishes (to legs, tables and/or rotating tablet), please add one-time upcharge of \$400 List per color per order.
- Metal legs available in #92 Polished Aluminum and the following finishes: #06 Charcoal Grey and #90 Metallic Silver.
- Non-skid glides available for hard surface floors. Please specify “-NS02B” after model number and add \$20 List per chair.
- Please refer to pages 11-12 for two-tone upholstery examples, yardage requirements and pricing.
- All dimensions are nominal.

TABLE PRODUCT FEATURES:

- Five table options: 30-degree, 45-degree, 90-degree, in-line or end table.
- Tables manufactured in Maple, Walnut and White Oak.
- All standard and custom wood finishes available.
- For custom finishes (to tables, legs and/or rotating tablets), please add one-time upcharge of \$400 List per color per order.
- Laminate and Corian tops available (venerer body as standard, finish must be specified).
- For laminate top and body, or Corian top with laminate body, please specify and contact Customer Service for pricing.
- For Corian tops, specify “-CO” next to model number and select color. Corian top is affixed to table surface increasing overall table height by 1/2". Please note that a 1/8" reveal will be present.
- Each unit comes standard with four (4) 5¹/₂" high Beech wood or metal legs.
- Metal legs available in #92 Polished Aluminum and the following finishes: #06 Charcoal Grey and #90 Metallic Silver.
- Non-skid glides available for hard surface floors. Please specify “-NS02B” after model number and add \$20 List per unit.
- Tables join together with all lounge, bench and mid-size bench models as well as Leaflette lounge and bench units.
- Models can join together as is, or to reduce the amount of legs as well as provide a more permanent connection, a ganging leg option is also available.
- All dimensions are nominal.

CORIAN® COLORS:

Designer White
Linen
Rain Cloud
Witch Hazel

Corian® is a registered trademark of Dupont.

LEAF MODULAR

designed by david dahl



SIN #711-16

MID AND FULL SIZE BENCH PRODUCT FEATURES:

- Mid-size benches available in five sizes to enable straight or curved configurations. Full-size bench offered in one size only.
- Each unit comes standard with four (4) 5¹/₂" high Beech wood or metal legs.
- All standard and custom wood finishes available on Beech.
- For custom finishes (to legs, tables and/or rotating tablets), please add one-time upcharge of \$400 List per color per order.
- Metal legs available in #92 Polished Aluminum and the following finishes: #06 Charcoal Grey and #90 Metallic Silver.
- Non-skid glides available for hard surface floors. Please specify "-NS02B" after model number and add \$20 List per unit.
- Models can join together as is, or to reduce the amount of legs as well as provide a more permanent connection, a ganging leg option is also available.
- All dimensions are nominal.

ROTATING TABLET:

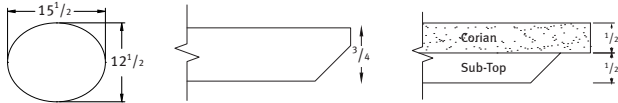

Tablet Shape

Veneer/Laminate Top - Edge Profile

Corian Top - Edge Profile

- Tablet available on lounge and love seat models and is affixed to right or left arm/side, as specified.
- Tablet size is 15¹/₂" W x 12¹/₂" D x 3/4" thick with 360-degree turning radius.
- Three tablet surface options: veneer, laminate and Corian.
- Veneer offered in Maple, Walnut and White Oak, in all standard and custom wood finishes.
- For custom finishes (to rotating tablet, legs and/or tables, please add one-time upcharge of \$400 List per color per order.
- Laminate is applied to tablet top surface only.
- For standard laminates, refer to Standard Finish Card.
- For custom laminates, add \$500 List per color per order. Pre-approval required, please contact Customer Service.
- Corian available in four standard colors. For non-standard options, please contact Customer Service for pricing.
- For maximum durability, a laminate or Corian surface with a clear coat edge finish is recommended.
- Tablet mounting post available in #91 Chrome and the following finishes: #06 Charcoal Grey and #90 Metallic Silver.
- Tablet mounting post will match leg finish unless otherwise specified. For legs finished in #92 Polished Aluminum, tablet mounting post will be #91 Chrome as standard.

TABLET EDGE FINISH SPECIFICATIONS:

- For veneer tops, edge finish will always match the top finish color, unless otherwise specified.
- For standard laminate tops (laminate cannot be applied to the edge):
 - Wood grain laminates, edge finish will match the laminate top color, unless otherwise specified.
 - Solid color laminates, edge finish will be natural (clear coat) as standard, unless otherwise specified.
- For Corian tops:
 - Designer White, Rain Cloud and Linen colors, edge will be white as standard, unless otherwise specified.
 - Witch Hazel, edge will be natural (clear coat) as standard, unless otherwise specified.
- Edges are also available in all standard wood finishes, please specify. For custom edge finishes, please add one-time upcharge of \$400 List per color, per order.

LEAF MODULAR

designed by david dahl



SIN #711-16

MODULAR ARRANGEMENTS:

- Ganging leg connects two units together and reduces the overall quantity of legs.
- To specify, please refer to units with “-G” in the model number.
- **Note: Please include layout drawings or sketch with each order.**
- Field assembly required.

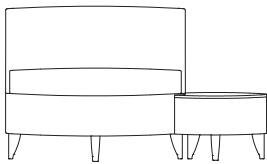

Standard Leg - Front View

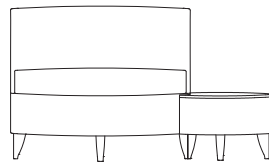

Ganging Leg - Front View

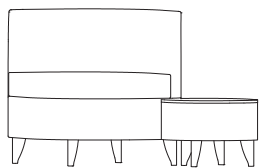

Standard Leg - Side View

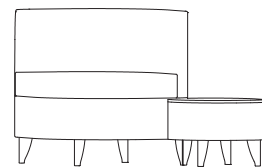

Ganging Leg - Side View

LEAF MODULAR

designed by david dahl



SIN #711-16

NOTES:

- Units available individually or in modular combinations with tables and mid-size benches (not ganged).
- For modular arrangements utilizing shared legs, please refer to models on page 7.
- Models designated with a -V feature clean-out between seat and back for maintenance ease.
- Each unit comes standard with four (4) 5¹/₂" high Beech wood or metal legs.
- Refer to page 11 for two-tone upholstery examples and yardage requirements.



SPECIFY:

1. Model number
2. Leg finish
3. Upholstery selection
4. Options, as applicable

ORDERING EXAMPLE:

#3700-TAR03-NS02B

Lounge Chair
Veneer Tablet, Right
Non-Skid Glides

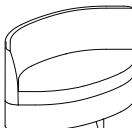
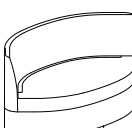
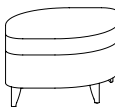
MODEL NUMBER	PRODUCT SPECIFICATIONS	FABRIC GRADES							LEATHER GRADES							
		COM	1	2	COL			3	4	5	6	7	8	L1	L2	L3
3700 	Lounge Chair W 37 D 27 ¹ / ₄ H 31 Seat Height 18 ¹ / ₂ Inside Seat Width 33 Inside Seat Depth 22 3 Yds. 45 lbs. COL 60 Sq. Ft. TB 133, add \$138 List	1286	1457	1498	1570	1642	1712	1784	1850	1923	2254	2496	2732			
3700-V 	Lounge Chair with Clean-Out W 37 D 27 ¹ / ₄ H 31 Seat Height 18 ¹ / ₂ Inside Seat Width 33 Inside Seat Depth 23 ¹ / ₄ 3 ³ / ₄ Yds. 45 lbs. COL 75 Sq. Ft. TB 133, add \$173 List	1374	1587	1638	1729	1819	1906	1997	2079	2170	2583	2886	3182			
3702 	Love Seat W 55 D 29 ¹ / ₄ H 31 Seat Height 18 ¹ / ₂ Inside Seat Width 48 Inside Seat Depth 22 5 Yds. 55 lbs. COL 100 Sq. Ft. TB 133, add \$230 List	1805	2089	2157	2278	2399	2514	2635	2745	2866	3417	3821	4215			
3702-V 	Love Seat with Clean-Out W 55 D 29 ¹ / ₄ H 31 Seat Height 18 ¹ / ₂ Inside Seat Width 48 Inside Seat Depth 23 ¹ / ₄ 5 ¹ / ₂ Yds. 55 lbs. COL 110 Sq. Ft. TB 133, add \$253 List	1980	2292	2367	2500	2633	2760	2893	3014	3147	3753	4198	4631			
3705 	Full Size Bench W 37 D 27 ¹ / ₄ H 18 ¹ / ₂ Seat Height 18 ¹ / ₂ 2 Yds. 30 lbs. COL 40 Sq. Ft. TB 133, add \$96 List	1037	1151	1178	1226	1275	1321	1369	1413	1462	1682	1844	2001			

OPTIONS (XXXX - REFERS TO CHAIR/BENCH MODEL NUMBER)

MODEL	DESCRIPTION	LIST
XXXX-TAR03	Veneer/Laminate Rotating Tablet, Right (as seated)	383
XXXX-TAL03	Veneer/Laminate Rotating Tablet, Left (as seated)	383
XXXX-TAR03-CO	Corian Rotating Tablet, Right (as seated)	686
XXXX-TAL03-CO	Corian Rotating Tablet, Left (as seated)	686
XXXX-MB02	Moisture Barrier, Lounge Chair (with or without clean-out)	95
XXXX-MB03	Moisture Barrier, Love Seat (with or without clean-Out)	145
XXXX-NS02B	Non-Skid Glides	20

NOTES:

- Units available individually or in modular combinations with lounge and full size bench models as well as connecting tables (not ganged).
- For modular arrangements utilizing shared legs, please refer to models on page 8.
- Each unit comes standard with four (4) 5¹/₂" high Beech wood or metal legs.
- Refer to page 12 for two-tone upholstery examples and yardage requirements.

SPECIFY:

1. Model number
2. Leg finish
3. Upholstery selection
4. Options, as applicable

ORDERING EXAMPLE:

#3715-NS02B

In-Line Bench
Non-Skid Glides

**LEAF
MODULAR**

designed by david dahl



SIN #711-16

MODEL NUMBER	PRODUCT SPECIFICATIONS	FABRIC GRADES								LEATHER GRADES			
		COM	1	2	COL			7	8	L1	L2	L3	
3710 	Mid-Size Bench W 28 ¹ / ₄ D 21 ¹ / ₂ H 18 ¹ / ₂ Seat Height 18 ¹ / ₂ 1 ³ / ₄ Yds. 28 lbs. COL 35 Sq. Ft. TB 133, add \$84 List	986	1086	1110	1152	1194	1235	1277	1315	1358	1551	1692	1830
3715 	Mid-Size In-Line Bench W 23 ¹ / ₂ D 21 ¹ / ₂ H 18 ¹ / ₂ Seat Height 18 ¹ / ₂ 1 ³ / ₄ Yds. 27 lbs. COL 35 Sq. Ft. TB 133, add \$84 List	959	1059	1083	1125	1167	1208	1250	1288	1331	1524	1665	1803
3720 	Mid-Size In-Line/End Bench W 26 D 21 ¹ / ₂ H 18 ¹ / ₂ Seat Height 18 ¹ / ₂ 1 ³ / ₄ Yds. 27 lbs. COL 35 Sq. Ft. TB 133, add \$84 List	937	1037	1061	1103	1145	1186	1228	1266	1309	1502	1643	1781
3730 	Mid-Size 30-Degree Bench W 27 ¹ / ₄ D 21 ¹ / ₂ H 18 ¹ / ₂ Seat Height 18 ¹ / ₂ 1 ¹ / ₂ Yds. 27 lbs. COL 30 Sq. Ft. TB 133, add \$72 List	937	1023	1043	1079	1115	1150	1186	1219	1256	1421	1542	1660
3745 	Mid-Size 45-Degree Bench W 28 D 22 H 18 ¹ / ₂ Seat Height 18 ¹ / ₂ 1 ¹ / ₂ Yds. 27 lbs. COL 30 Sq. Ft. TB 133, add \$72 List	937	1023	1043	1079	1115	1150	1186	1219	1256	1421	1542	1660

OPTIONS (XXXX - REFERS TO BENCH MODEL NUMBER)

MODEL	DESCRIPTION	LIST
XXXX-NS02B	Non-Skid Glides	20

LEAF MODULAR

designed by david dahl



SIN #711-16

NOTES:

- Tables manufactured in Maple, Walnut and White Oak.
- For Corian tops, specify “-CO” next to model number and select color. Corian top is affixed to table surface increasing overall table height by 1/2" and features a 1/8" reveal.
- Each unit comes standard with four (4) 5 1/2" high Beech wood or metal legs.
- Tables connect with all lounge, bench and mid-size bench models as well as Leaflette lounge and bench units.
- For modular arrangements utilizing shared legs, please refer to models on page 9.

SPECIFY:

1. Model number
2. Wood species
3. Wood finish
4. Leg finish
5. Options, as applicable

ORDERING EXAMPLE:

#3750-NS02B

In-Line Table
Non-Skid Glides

MODEL NUMBER	PRODUCT SPECIFICATIONS	TABLE TOP FINISH	
		VENEER OR LAMINATE	CORIAN (-CO)
3750 	In-Line Table W 16 ³ / ₄ D 16 ¹ / ₂ H 13 ¹ / ₄ 15 lbs.	928	1362
3750-30 	30-Degree Table W 18 ¹ / ₄ D 16 ¹ / ₂ H 13 ¹ / ₄ 15 lbs.	920	1355
3750-45 	45-Degree Table W 19 D 16 ³ / ₄ H 13 ¹ / ₄ 15 lbs.	928	1362
3750-90 	90-Degree Table W 23 D 19 H 13 ¹ / ₄ 15 lbs.	997	1623
3755 	In-Line/End Table W 19 D 16 ¹ / ₂ H 13 ¹ / ₄ 15 lbs.	937	1907

OPTIONS (XXXX - REFERS TO TABLE MODEL NUMBER)

MODEL	DESCRIPTION	LIST
XXXX-NS02B	Non-Skid Glides	20

NOTES:

- Models feature a shared ganging leg (-G) to connect units together.
- For stand-alone units (without ganging connector), please refer to models on page 4.
- Models designated with a -V feature clean-out between seat and back for maintenance ease.
- Each unit comes standard with four (4) 5¹/₂" high Beech wood or metal legs.
- Refer to page 11 for two-tone upholstery examples and yardage requirements.

SPECIFY:

1. Model number
2. Leg finish
3. Upholstery selection
4. Options, as applicable

Please include layout drawings or sketch with each order.

ORDERING EXAMPLE:

#3700-V-G-TAR03-NS02B

Lounge Chair with Clean-Out Veneer Tablet, Right Non-Skid Glides

LEAF MODULAR

designed by david dahl

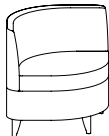
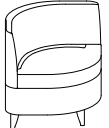
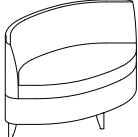
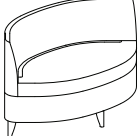
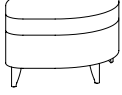

SIN #711-16

MODEL NUMBER	PRODUCT SPECIFICATIONS	FABRIC GRADES								LEATHER GRADES			
		COM	1	2	COL			7	8	L1	L2	L3	
3700-G 	Lounge Chair, Ganging W 37 D 27 ¹ / ₄ H 31 Seat Height 18 ¹ / ₂ Inside Seat Width 33 Inside Seat Depth 22 3 Yds. 45 lbs. COL 60 Sq. Ft. TB 133, add \$144 List	1343	1514	1555	1627	1699	1769	1841	1907	1980	2311	2553	2789
3700-V-G 	Lounge Chair with Clean-Out, Ganging W 37 D 27 ¹ / ₄ H 31 Seat Height 18 ¹ / ₂ Inside Seat Width 33 Inside Seat Depth 23 ¹ / ₄ 3 ³ / ₄ Yds. 45 lbs. COL 75 Sq. Ft. TB 133, add \$180 List	1433	1646	1697	1788	1878	1965	2056	2138	2229	2642	2945	3241
3702-G 	Love Seat, Ganging W 55 D 29 ¹ / ₄ H 31 Seat Height 18 ¹ / ₂ Inside Seat Width 48 Inside Seat Depth 22 5 Yds. 55 lbs. COL 100 Sq. Ft. TB 133, add \$240 List	1864	2148	2216	2337	2458	2573	2694	2804	2925	3476	3880	4274
3702-V-G 	Love Seat with Clean-Out, Ganging W 55 D 29 ¹ / ₄ H 31 Seat Height 18 ¹ / ₂ Inside Seat Width 48 Inside Seat Depth 23 ¹ / ₄ 5 ¹ / ₂ Yds. 55 lbs. COL 110 Sq. Ft. TB 133, add \$264 List	2039	2351	2426	2559	2692	2819	2952	3073	3206	3812	4257	4690
3705-G 	Full Size Bench, Ganging W 37 D 27 ¹ / ₄ H 18 ¹ / ₂ Seat Height 18 ¹ / ₂ 2 Yds. 30 lbs. COL 40 Sq. Ft. TB 133, add \$96 List	1097	1211	1238	1286	1335	1381	1429	1473	1522	1742	1904	2061

OPTIONS (XXXX - REFERS TO CHAIR/BENCH MODEL NUMBER)

MODEL	DESCRIPTION	LIST
XXXX-TAR03	Veneer/Laminate Rotating Tablet, Right (as seated)	383
XXXX-TAL03	Veneer/Laminate Rotating Tablet, Left (as seated)	383
XXXX-TAR03-CO	Corian Rotating Tablet, Right (as seated)	686
XXXX-TAL03-CO	Corian Rotating Tablet, Left (as seated)	686
XXXX-MB02	Moisture Barrier, Lounge Chair (with or without clean-out)	95
XXXX-MB03	Moisture Barrier, Love Seat (with or without clean-Out)	145
XXXX-NS02B	Non-Skid Glides	20

LEAF MODULAR

designed by david dahl



NOTES:

- Models feature a shared ganging leg (-G) to connect units together.
- For stand-alone units (without ganging connector), please refer to models on page 5.
- Each unit comes standard with four (4) 5¹/₂" high Beech wood or metal legs.
- Refer to page 12 for two-tone upholstery examples and yardage requirements.

SPECIFY:

1. Model number
2. Leg finish
3. Upholstery selection
4. Options, as applicable



Please include layout drawings or sketch with each order.

ORDERING EXAMPLE:

#3715-G-NS02B

In-Line Bench
Non-Skid Glides

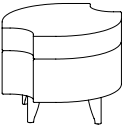
SIN #711-16

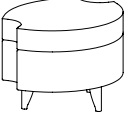
MODEL NUMBER	PRODUCT SPECIFICATIONS	FABRIC GRADES							LEATHER GRADES				
		COM	1	2	COL 3	4	5	6	7	8	L1	L2	L3
3710-G 	Mid-Size Bench, Ganging W 28 ³ / ₄ D 21 ¹ / ₂ H 18 ¹ / ₂ Seat Height 18 ¹ / ₂ 1 ³ / ₄ Yds. 26 lbs. COL 35 Sq. Ft. TB 133, add \$84 List	1044	1144	1168	1210	1252	1293	1335	1373	1416	1609	1750	1888
3715-G 	Mid-Size In-Line Bench, Ganging W 23 ¹ / ₂ D 21 ¹ / ₂ H 18 ¹ / ₂ Seat Height 18 ¹ / ₂ 1 ³ / ₄ Yds. 25 lbs. COL 35 Sq. Ft. TB 133, add \$84 List	1018	1118	1142	1184	1226	1267	1309	1347	1390	1583	1724	1862
3720-G 	Mid-Size In-Line/End Bench, Ganging W 26 D 21 ¹ / ₂ H 18 ¹ / ₂ Seat Height 18 ¹ / ₂ 1 ³ / ₄ Yds. 25 lbs. COL 35 Sq. Ft. TB 133, add \$84 List	996	1096	1120	1162	1204	1245	1287	1325	1368	1561	1702	1840
3730-G 	Mid-Size 30-Degree Bench, Ganging W 27 ¹ / ₄ D 21 ¹ / ₂ H 18 ¹ / ₂ Seat Height 18 ¹ / ₂ 1 ¹ / ₂ Yds. 25 lbs. COL 30 Sq. Ft. TB 133, add \$72 List	996	1082	1102	1138	1174	1209	1245	1278	1315	1480	1601	1719
3745-G 	Mid-Size 45-Degree Bench, Ganging W 28 D 22 H 18 ¹ / ₂ Seat Height 18 ¹ / ₂ 1 ¹ / ₂ Yds. 25 lbs. COL 30 Sq. Ft. TB 133, add \$72 List	996	1082	1102	1138	1174	1209	1245	1278	1315	1480	1601	1719

OPTIONS (XXXX - REFERS TO CHAIR MODEL NUMBER)

MODEL	DESCRIPTION	LIST
XXXX-NS02B	Non-Skid Glides	20

NOTES:

- Models feature a shared ganging leg (-G) to connect units together.
- For stand-alone units (without ganging connector), please refer to models on page 6.
- Each unit comes standard with four (4) 5 1/2" high Beech wood or metal legs.
- Tables manufactured in Maple, Walnut and White Oak.
- For Corian tops, specify "-CO" next to model number and select color. Corian top is affixed to table surface increasing overall table height by 1/2" and features a 1/8" reveal .
- Tables connect with all lounge, bench and mid-size bench models as well as Leaflette lounge and bench units.

SPECIFY:

1. Model number
2. Wood species
3. Wood finish
4. Leg finish
5. Options, as applicable

Please include layout drawings or sketch with each order.

ORDERING EXAMPLE:



#3750-45-G-NS02B
45-Degree Table
Non-Skid Glides

**LEAF
MODULAR**

designed by david dahl

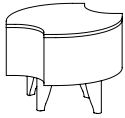

SIN #711-16

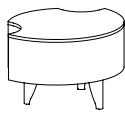
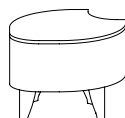
MODEL NUMBER	PRODUCT SPECIFICATIONS	TABLE TOP FINISH	
		VENEER OR LAMINATE	CORIAN (-CO)
3750-G 	In-Line Table, Ganging W 16 ³ / ₄ D 16 ¹ / ₂ H 13 ¹ / ₄ 15 lbs.	987	1424
3750-30-G 	30-Degree Table, Ganging W 18 ¹ / ₄ D 16 ¹ / ₂ H 13 ¹ / ₄ 15 lbs.	979	1414
3750-45-G 	45-Degree Table, Ganging W 19 D 16 ³ / ₄ H 13 ¹ / ₄ 15 lbs.	987	1424
3750-90-G 	90-Degree Table, Ganging W 23 D 19 H 13 ¹ / ₄ 15 lbs.	1056	1680
3755-G 	In-Line/End Table, Ganging W 19 D 16 ¹ / ₂ H 13 ¹ / ₄ 15 lbs.	996	1966

OPTIONS (XXXX - REFERS TO TABLE MODEL NUMBER)

MODEL	DESCRIPTION	LIST
XXXX-NS02B	Non-Skid Glides	20

LEAF MODULAR

designed by david dahl



SIN #711-16

CONFIGURATION AND ORDERING EXAMPLES

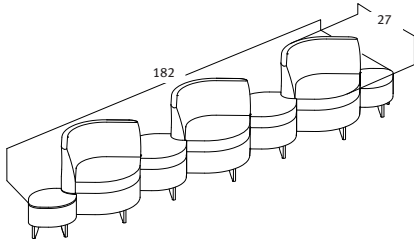

Qty	Model #	Description	COM List
3	3700-G	Lounge Chairs (\$1,343 each)	4,029
2	3755-G	In-Line/End Tables (\$996 each)	1,992
2	3715-G	In-Line Benches (\$1,018 each)	2,036
7			8,057

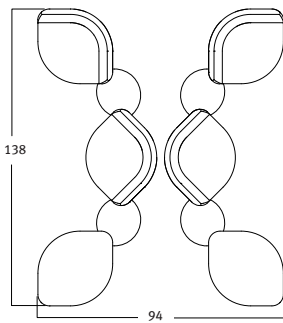

Qty	Model #	Description	COM List
4	3700-G	Lounge Chairs (\$1,343 each)	5,372
2	3705-G	Full Size Benches (\$1,097 each)	2,194
4	3750-45-G	45-Degree Tables (\$987 each)	3,948
10			11,514

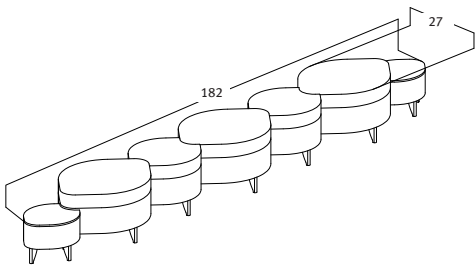

Qty	Model #	Description	COM List
3	3705-G	Full Size Benches (\$1,097 each)	3,291
2	3715-G	Mid-Size In-Line Benches (\$1,018 each)	2,036
2	3755-G	In-Line/End Tables (\$996 each)	1,992
7			7,319

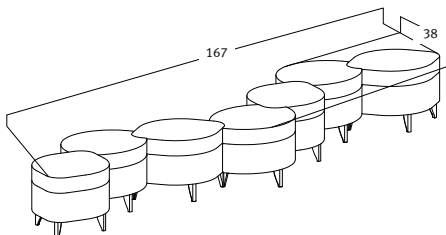

Qty	Model #	Description	COM List
4	3710-G	Mid-Size Benches (\$1,044 each)	4,176
3	3745-G	Mid-Size 45-Degree Benches (\$996 each)	2,988
7			7,164

UPHOLSTERY COMBINATIONS:

For fabric, vinyl or leather upholstery combinations, refer to the pricing below:

- When combining **two** COM/COV/COL fabrics, or fabrics with the same grade, add the following (per unit):
 - › \$65 List for lounge chairs
 - › \$105 List for love seats
- When combining **three or more** COM/COV/COL fabrics, or fabrics with the same grade, add the following (per unit):
 - › \$75 List for lounge chairs
 - › \$115 List for love seats

- When combining different grades of fabric, price will be based on the highest grade specified.
- Two-tone upholstery examples and yardage requirements for the most common combinations are listed below. Additional combinations available, please contact Customer Service for yardage requirements and pricing.
- Note: Yardage amounts are based on fabric which is plain (i.e. non-directional) and a full 54" wide.
- **Appropriate upholstery code must be included on order.**

LEAF
MODULAR

designed by david dahl



SIN #711-16

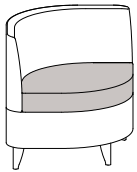

Code LM1

Model COM Requirement
3700 Seat Cushion Only = 1 yd.
3700-G Balance of Chair = 2¹/₂ yds.

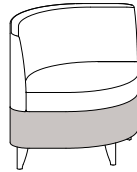

Code LM2

Model COM Requirement
3700 Seat Box Only = 3³/₄ yd.
3700-G Balance of Chair = 2¹/₂ yds.

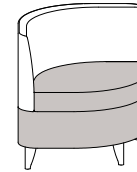

Code LM3

Model COM Requirement
3700 Seat Cushion & Seat Box = 1³/₄ yds.
3700-G Balance of Chair = 1³/₄ yds.

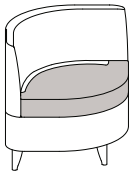

Code LM4

Models COM Requirement
3700-V Seat Cushion Only = 1 yd.
3700-V-G Balance of Chair = 2³/₄ yds.

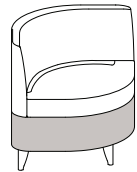

Code LM5

Models COM Requirement
3700-V Seat Box Only = 3³/₄ yd.
3700-V-G Balance of Chair = 3 yds.

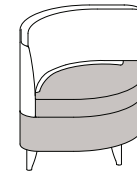

Code LM6

Models COM Requirement
3700-V Seat Cushion & Seat Box = 2 yds.
3700-V-G Balance of Chair = 2¹/₄ yds.

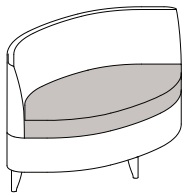

Code LM7

Models COM Requirement
3702 Seat Cushion Only = 1¹/₂ yds.
3702-G Balance of Love Seat = 3¹/₂ yds.

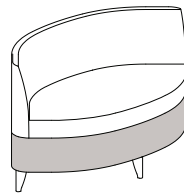

Code LM8

Models COM Requirement
3702 Seat Box Only = 1¹/₂ yds.
3702-G Balance of Love Seat = 3¹/₂ yds.

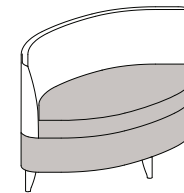

Code LM9

Models COM Requirement
3702 Seat Cushion & Seat Box = 3 yds.
3702-G Balance of Love Seat = 2¹/₂ yds.

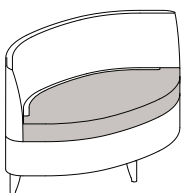

Code LM10

Models COM Requirement
3702-V Seat Cushion Only = 2 yds.
3702-V-G Balance of Love Seat = 3³/₄ yds.

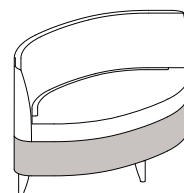

Code LM11

Models COM Requirement
3702-V Seat Box Only = 1¹/₂ yds.
3702-V-G Balance of Love Seat = 4¹/₄ yds.

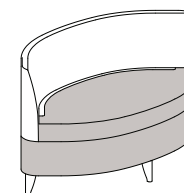

Code LM12

Models COM Requirement
3702-V Seat Cushion & Seat Box = 3¹/₄ yds.
3702-V-G Balance of Love Seat = 2³/₄ yds.

LEAF MODULAR

designed by david dahl



UPHOLSTERY COMBINATIONS:

For fabric, vinyl or leather upholstery combinations, refer to the pricing below:

- When combining **two** COM/COV/COL fabrics, or fabrics with the same grade, add the following (per unit):
 - > \$65 List for lounge chairs
 - > \$105 List for love seats
- When combining **three or more** COM/COV/COL fabrics, or fabrics with the same grade, add the following (per unit):
 - > \$75 List for lounge chairs
 - > \$115 List for love seats
- When combining different grades of fabric, price will be based on the highest grade specified.
- Two-tone upholstery examples and yardage requirements for the most common combinations are listed below. Additional combinations available, please contact Customer Service for yardage requirements and pricing.
- Note: Yardage amounts are based on fabric which is plain (i.e. non-directional) and a full 54" wide.
- **Appropriate upholstery code must be included on order.**

SIN #711-16

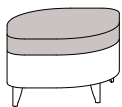

Code LM13

Model COM Requirement
 3705 Seat Cushion = 1¹/₄ yds.
 3705-G Seat Box = 3/4 yd.

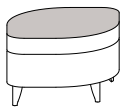

Code LM14

Model COM Requirement
 3705 Top of Seat Only = 1 yd.
 3705-G Balance of Bench = 1 yd.

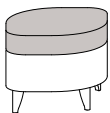

Code LM15

Model COM Requirement
 3710 Seat Cushion = 1¹/₄ yds.
 3710-G Seat Box = 3/4 yd.

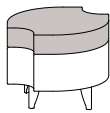

Code LM16

Model COM Requirement
 3715 Seat Cushion = 1¹/₄ yds.
 3715-G Seat Box = 3/4 yd.

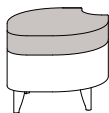

Code LM17

Model COM Requirement
 3720 Seat Cushion = 1¹/₄ yds.
 3720-G Seat Box = 3/4 yd.

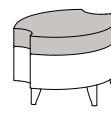

Code LM18

Model COM Requirement
 3730 Seat Cushion = 1¹/₄ yds.
 3730-G Seat Box = 3/4 yd.



Code LM19

Model COM Requirement
 3745 Seat Cushion = 1¹/₄ yds.
 3745-G Seat Box = 3/4 yd.

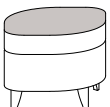

Code LM20

Model COM Requirement
 3710 Top of Seat Only = 3/4 yd.
 3710-G Balance of Bench = 1¹/₄ yds.

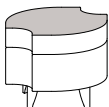

Code LM21

Model COM Requirement
 3715 Top of Seat Only = 3/4 yd.
 3715-G Balance of Bench = 1¹/₄ yds.

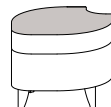

Code LM22

Model COM Requirement
 3720 Top of Seat Only = 3/4 yd.
 3720-G Balance of Bench = 1¹/₄ yds.

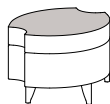

Code LM23

Model COM Requirement
 3730 Top of Seat Only = 3/4 yd.
 3730-G Balance of Bench = 1¹/₄ yds.



Code LM24

Model COM Requirement
 3745 Top of Seat Only = 3/4 yd.
 3745-G Balance of Bench = 1¹/₄ yds.

LEAFLETTE KIDS BENCHES

designed by david dahl



SIN #711-16

BENCH PRODUCT FEATURES:

- Units available individually or in modular combinations with lounge and full size bench models as well as connecting tables (not ganged).
- For modular arrangements utilizing shared legs, please refer to models on page 4.
- Each unit comes standard with four (4) 5¹/₂" high Beech wood or metal legs.
- All standard and custom wood finishes available on Beech.
- For custom finishes (to legs and/or tables), please add one-time upcharge of \$400 List per color per order.
- Metal legs available in #92 Polished Aluminum and the following powdercoat finishes: #06 Charcoal Grey and #90 Metallic Silver.
- Maximum weight capacity is 750 lbs.
- Non-skid glides available for hard surface floors. Please specify "-NS02B" after model number and add \$20 List per unit.
- When specifying non-skid glides on models with plinth base, add \$40 List per unit.
- Two-tone upholstery examples and yardage requirements featured on page 6.
- **Note: For modular configurations please include layout drawings or sketch with each order.**
- All dimensions are nominal.

TABLE PRODUCT FEATURES:

- Models feature a shared ganging leg (-G) to connect units together.
- For stand-alone units (without ganging connector), please refer to models on page 5.
- Tables manufactured in Maple Walnut and White Oak.
- All standard and custom wood finishes available.
- For custom finishes (to legs and/or tables) please add one-time upcharge of \$400 List per color per order.
- Laminate and Corian tops available (veneer body as standard finish must be specified).
- For Corian tops, specify "-CO" next to model number and select color. Corian top is affixed to table surface by ¹/₂". Please note that a ¹/₈" reveal will be present.
- Legs available in Beech wood or metal.
- Metal legs available in #92 Polished Aluminum and the following powdercoat finishes: #06 Charcoal Grey and #90 Metallic Silver.
- Non-skid glides available for hard surface floors. Please specify "-NS02B" after model number and add \$20 List per unit.
- Tables connect with all lounge bench and mid-size bench models as well as Leaflette lounge and bench units.
- **Note: Please include layout drawings or sketch with each order.**
- All dimensions are nominal.

CORIAN® COLORS:

Designer White
Linen
Rain Cloud
Witch Hazel

Corian® is a registered trademark of Dupont.

LEAFLETTE KIDS BENCHES

designed by david dahl



NOTES:

- Units available individually or in modular combinations (not ganged).
- For modular arrangements utilizing shared legs please refer to models on page 4.
- Each unit comes standard with four (4) 5¹/₂" high Beech wood or metal legs.
- Refer to page 7 for two-tone upholstery examples and yardage requirements.

SPECIFY:

1. Model number
2. Leg finish
3. Upholstery selection
4. Options, as applicable

ORDERING EXAMPLE:

#3774-NS02B
30-Degree Bench
Non-Skid Glides

SIN #711-16

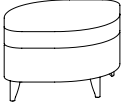
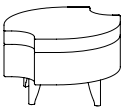
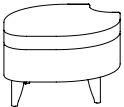
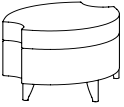
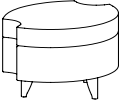
MODEL NUMBER	PRODUCT SPECIFICATIONS	FABRIC GRADES							LEATHER GRADES				
		COM	1	2	COL			8	L1	L2	L3		
3771 	Children's Bench W 28 ¹ / ₄ D 21 ¹ / ₂ H 15 Seat Height 15 1 ¹ / ₂ Yds. 18 lbs. COL 30 Sq. Ft. TB 133 add \$72 List	915	1001	1021	1057	1093	1128	1164	1197	1234	1399	1520	1638
3772 	Children's In-Line Bench W 23 ³ / ₄ D 21 ¹ / ₂ H 15 Seat Height 15 1 ¹ / ₂ Yds. 17 lbs. COL 30 Sq. Ft. TB 133 add \$72 List	915	1001	1021	1057	1093	1128	1164	1197	1234	1399	1520	1638
3773 	Children's In-Line/End Bench W 25 ³ / ₄ D 21 ¹ / ₂ H 15 Seat Height 15 1 ¹ / ₂ Yds. 18 lbs. COL 30 Sq. Ft. TB 133 add \$72 List	915	1001	1021	1057	1093	1128	1164	1197	1234	1399	1520	1638
3774 	Children's 30-Degree Bench W 27 ¹ / ₄ D 21 ¹ / ₂ H 15 Seat Height 15 1 ¹ / ₂ Yds. 18 lbs. COL 30 Sq. Ft. TB 133 add \$72 List	937	1023	1043	1079	1115	1150	1186	1219	1256	1421	1542	1660
3775 	Children's 45-Degree Bench W 27 ¹ / ₄ D 21 ¹ / ₂ H 15 Seat Height 15 1 ¹ / ₂ Yds. 18 lbs. COL 30 Sq. Ft. TB 133 add \$72 List	937	1023	1043	1079	1115	1150	1186	1219	1256	1421	1542	1660

OPTIONS (XXXX - REFERS TO BENCH MODEL NUMBER)

MODEL	DESCRIPTION	LIST
XXXX-NS02B	Non-Skid Glides	20

NOTES:

- Tables manufactured in Maple Walnut and White Oak.
- For Corian tops, specify “-CO” next to model number and select color. Corian top is affixed to table surface increasing overall table height by 1/2" and features 1/8" reveal.
- Each unit comes standard with four (4) 5 1/2" high Beech wood or metal legs.
- Tables connect with all lounge bench and mid-size bench models as well as Leaflette lounge and bench units.
- For modular arrangements utilizing shared legs please refer to page 5.

SPECIFY:

1. Model number
2. Wood species
3. Wood finish
4. Leg finish
5. Options, as applicable

ORDERING EXAMPLE:





#3750-30-NS02B
30-Degree Table
Non-Skid Glides

LEAFLETTE KIDS BENCHES

designed by david dahl

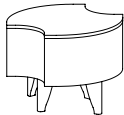
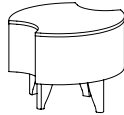

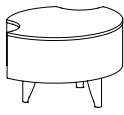
SIN #711-16

MODEL NUMBER	PRODUCT SPECIFICATIONS	TABLE TOP FINISHES	
		VENEER OR LAMINATE	CORIAN (-CO)
3750 	In-Line Table W 16 ³ / ₄ D 16 ¹ / ₂ H 13 ¹ / ₄ 15 lbs.	928	1362
3750-30 	30-Degree Table W 18 ¹ / ₄ D 16 ¹ / ₂ H 13 ¹ / ₄ 15 lbs.	920	1355
3750-45 	45-Degree Table W 19 D 16 ³ / ₄ H 13 ¹ / ₄ 15 lbs.	928	1362
3750-90 	90-Degree Table W 23 D 19 H 13 ¹ / ₄ 15 lbs.	997	1623
3755 	In-Line/End Table W 19 D 16 ¹ / ₂ H 13 ¹ / ₄ 15 lbs.	937	1907

OPTIONS (XXXX - REFERS TO TABLE MODEL NUMBER)

MODEL	DESCRIPTION	LIST
XXXX-NS02B	Non-Skid Glides	20

LEAFLETTE KIDS BENCHES

designed by david dahl



SIN #711-16

NOTES:

- Models feature a shared ganging leg (-G) to connect units together.
- For stand-alone units (without ganging connector) please refer to models on page 2.
- Each unit comes standard with four (4) 5¹/₂" high Beech wood or metal legs.
- All standard and custom wood finishes available on Beech.
- Refer to page 7 for two-tone upholstery examples and yardage requirements.

SPECIFY:

1. Model number
2. Leg finish
3. Upholstery selection
4. Options, as applicable

ORDERING EXAMPLE:

#3772-G-NS02B

In-Line Bench
Non-Skid Glides

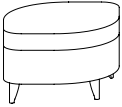
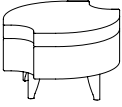
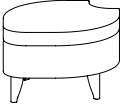
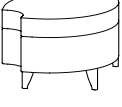
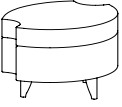
MODEL NUMBER	PRODUCT SPECIFICATIONS	FABRIC GRADES								LEATHER GRADES			
		COM	1	2	COL			6	7	8	L1	L2	L3
3771-G 	Children's Bench, Ganging W 28 ¹ / ₄ D 21 ¹ / ₂ H 15 Seat Height 15 1 ¹ / ₂ Yds. 18 lbs. COL 30 Sq. Ft. TB 133 add \$72 List	972	1058	1078	1114	1150	1185	1221	1254	1291	1456	1577	1695
3772-G 	Children's In-Line Bench, Ganging W 23 ¹ / ₂ D 21 ¹ / ₂ H 15 Seat Height 15 1 ¹ / ₂ Yds. 17 lbs. COL 30 Sq. Ft. TB 133 add \$72 List	972	1058	1078	1114	1150	1185	1221	1254	1291	1456	1577	1695
3773-G 	Children's In-Line/End Bench, Ganging W 25 ³ / ₄ D 21 ¹ / ₂ H 15 Seat Height 15 1 ¹ / ₂ Yds. 18 lbs. COL 30 Sq. Ft. TB 133 add \$72 List	972	1058	1078	1114	1150	1185	1221	1254	1291	1456	1577	1695
3774-G 	Children's 30-Degree Bench, Ganging W 27 ¹ / ₄ D 21 ¹ / ₂ H 15 Seat Height 15 1 ¹ / ₂ Yds. 18 lbs. COL 30 Sq. Ft. TB 133 add \$72 List	994	1080	1100	1136	1172	1207	1243	1276	1313	1478	1599	1717
3775-G 	Children's 45-Degree Bench, Ganging W 27 ¹ / ₄ D 21 ¹ / ₂ H 15 Seat Height 15 1 ¹ / ₂ Yds. 18 lbs. COL 30 Sq. Ft. TB 133 add \$72 List	994	1080	1100	1136	1172	1207	1243	1276	1313	1478	1599	1717

OPTIONS (XXXX - REFERS TO BENCH MODEL NUMBER)

MODEL	DESCRIPTION	LIST
XXXX-NS02B	Non-Skid Glides	20

NOTES:

- Models feature a shared ganging leg (-G) to connect units together.
- Tables manufactured in Maple Walnut and White Oak.
- For Corian tops, specify “-CO” next to model number and select color. Corian top is affixed to table surface increasing overall table height by 1/2" and features 1/8" reveal.
- Each unit comes standard with four (4) 5 1/2" high Beech wood or metal legs.
- Tables connect with all lounge bench and mid-size bench models as well as Leaflette lounge and bench units.

SPECIFY:

1. Model number
2. Wood species
3. Wood finish
4. Leg finish
5. Options as applicable

ORDERING EXAMPLE:

#3750-G-NS02B



In-Line Table
Non-Skid Glides

LEAFLETTE KIDS BENCHES

designed by david dahl

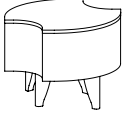

SIN #711-16

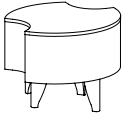
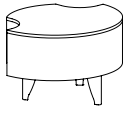
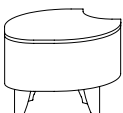
MODEL NUMBER	PRODUCT SPECIFICATIONS	TABLE TOP FINISHES	
		VENEER OR LAMINATE	CORIAN (-CO)
3750-G 	In-Line Table, Ganging W 16 ³ / ₄ D 16 ¹ / ₂ H 13 ¹ / ₄ 15 lbs.	987	1424
3750-30-G 	30-Degree Table, Ganging W 18 ¹ / ₄ D 16 ¹ / ₂ H 13 ¹ / ₄ 15 lbs.	979	1414
3750-45-G 	45-Degree Table, Ganging W 19 D 16 ³ / ₄ H 13 ¹ / ₄ 15 lbs.	987	1424
3750-90-G 	90-Degree Table, Ganging W 23 D 19 H 13 ¹ / ₄ 15 lbs.	1056	1680
3755-G 	In-Line/End Table, Ganging W 19 D 16 ¹ / ₂ H 13 ¹ / ₄ 15 lbs.	996	1966

OPTIONS (XXXX - REFERS TO TABLE MODEL NUMBER)

MODEL	DESCRIPTION	LIST
XXXX-NS02B	Non-Skid Glides	20

LEAFLETTE KIDS BENCHES

designed by david dahl



NOTES:

- Units available individually or in modular combinations with other bud models.
- Each unit features 2" black laminate recessed plinth base.
- Buds can join with other Leaf and Leaflette models but they cannot be affixed together (ganging connection not available).
- Maximum weight capacity is 300 lbs.
- Two-tone upholstery examples and yardage requirements featured on page 7.



SPECIFY:

1. Model number
2. Upholstery selection

ORDERING EXAMPLE:

#3781
In-Line Bench

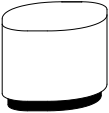
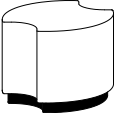
SIN #711-16

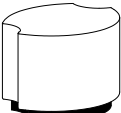
MODEL NUMBER	PRODUCT SPECIFICATIONS	FABRIC GRADES								LEATHER GRADES			
		COM	1	2	COL			6	7	8	L1	L2	L3
3780 	Buds Children's Bench, Plinth Base W 22 ¹ / ₄ D 17 ¹ / ₄ H 15 Seat Height 15 1 ¹ / ₄ Yds. 13 lbs. COL 25 Sq. Ft. TB 133, add \$60 List	809	880	897	928	958	987	1017	1044	1075	1212	1313	1412
3781 	Buds Children's In-Line Bench, Plinth Base W 18 ¹ / ₂ D 17 ¹ / ₂ H 15 Seat Height 15 1 Yd. 12 lbs. COL 20 Sq. Ft. TB 133, add \$48 List	796	853	867	891	915	938	962	984	1009	1119	1200	1278
3782 	Buds Children's In-Line/End Bench, Plinth Base W 19 ³ / ₄ D 17 ¹ / ₄ H 15 Seat Height 15 1 Yd. 12 lbs. COL 20 Sq. Ft. TB 133, add \$48 List	796	853	867	891	915	938	962	984	1009	1119	1200	1278
3783 	Buds Children's 45-Degree Bench, Plinth Base W 21 ¹ / ₂ D 17 ¹ / ₄ H 15 Seat Height 15 1 Yd. 12 lbs. COL 20 Sq. Ft. TB 133, add \$48 List	796	853	867	891	915	938	962	984	1009	1119	1200	1278

OPTIONS (XXXX - REFERS TO BENCH MODEL NUMBER)

MODEL	DESCRIPTION	LIST
XXXX-NS02B	Non-Skid Glides	40

UPHOLSTERY COMBINATIONS:

For fabric vinyl or leather upholstery combinations refer to the pricing below:

- When combining **two** COM/COV/COL fabrics or fabrics with the same grade price will be \$65 List (per unit).
- When combining **three or more** COM/COV/COL fabrics or fabrics with the same grade price will be \$75 List (per unit).
- When combining different grades of fabric price will be based on the highest grade specified.
- Two-tone upholstery examples and yardage requirements for the most common combinations are listed below. Additional combinations available please contact Customer Service for yardage requirements and pricing.
- Note: Yardage amounts are based on fabric which is plain (i.e. non-directional) and a full 54" wide.
- **Appropriate upholstery code must be included on order.**

LEAFLETTE KIDS BENCHES

designed by david dahl



SIN #711-16



Code LC4
Model COM Requirement
3771 Seat Cushion = 1 yd.
3771-G Seat Box = 3/4 yd.



Code LC5
Model COM Requirement
3772 Seat Cushion = 1 yd.
3772-G Seat Box = 3/4 yd.



Code LC6
Model COM Requirement
3773 Seat Cushion = 1 yd.
3773-G Seat Box = 3/4 yd.



Code LC7
Model COM Requirement
3771 Top of Seat Only = 3/4 yd.
3771-G Balance of Bench = 1 yd.



Code LC8
Model COM Requirement
3772 Top of Seat Only = 3/4 yd.
3772-G Balance of Bench = 1 yd.



Code LC9
Model COM Requirement
3773 Top of Seat Only = 3/4 yd.
3773-G Balance of Bench = 1 yd.



Code LC10
Model COM Requirement
3780 Top of Seat Only = 3/4 yd.
Balance of Bench = 1 yd.



Code LC11
Model COM Requirement
3781 Top of Seat Only = 3/4 yd.
Balance of Bench = 1 yd.



Code LC12
Model COM Requirement
3782 Top of Seat Only = 3/4 yd.
Balance of Bench = 1 yd.



Code LC13
Model COM Requirement
3783 Top of Seat Only = 3/4 yd.
Balance of Bench = 1 yd.

NOTES:

- Each unit comes standard with four (4) 5¹/₂" high Beech wood or metal legs.
- All standard and custom wood finishes available on Beech.
- For custom finishes, please add one-time upcharge of \$400 List per color per order.
- Metal legs available in #92 Polished Aluminum and the following finishes: #06 Charcoal Grey and #90 Metallic Silver.
- Refer to page 2 for two-tone upholstery examples and yardage requirements.

SPECIFY:

1. Model number
2. Leg finish
3. Upholstery selection
4. Options, as applicable

ORDERING EXAMPLE:

#3770-NS02B

Children's Lounge Chair
Non-Skid Glides

LEAFLETTE KIDS LOUNGE

designed by david dahl

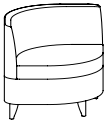

SIN #711-16

MODEL NUMBER	PRODUCT SPECIFICATIONS	FABRIC GRADES							LEATHER GRADES				
		COM	1	2	COL 3	4	5	6	7	8	L1	L2	L3
3770	 <p>Children's Lounge Chair W 28¹/₄ D 21¹/₂ H 24³/₄ Seat Height 15 Inside Seat Width 26¹/₄ Inside Seat Depth 17³/₄ 2¹/₂ Yds. 33 lbs. COL 50 Sq. Ft. TB 133, add \$120 List</p>	1100	1242	1276	1337	1397	1455	1515	1570	1631	1906	2108	2305

OPTIONS (XXXX - REFERS TO CHAIR MODEL NUMBER)

MODEL	DESCRIPTION	LIST
XXXX-NS02B	Non-Skid Glides	20

LEAFLETTE KIDS LOUNGE

designed by david dahl



UPHOLSTERY COMBINATIONS:

For fabric, vinyl or leather upholstery combinations, refer to the pricing below:

- When combining **two** COM/COV/COL fabrics, or fabrics with the same grade, add \$65 List per unit.
- When combining **three or more** COM/COV/COL fabrics, or fabrics with the same grade, add \$75 List per unit.
- When combining different grades of fabric, price will be based on the highest grade specified.
- Two-tone upholstery examples and yardage requirements for the most common combinations are listed below. Additional combinations available, please contact Customer Service for yardage requirements and pricing.
- Note: Yardage amounts are based on fabric which is plain (i.e. non-directional) and a full 54" wide.
- **Appropriate upholstery code must be included on order.**

SIN #711-16



Code LC1

<u>Model</u>	<u>COM Requirement</u>
3770	Seat Cushion Only = $\frac{3}{4}$ yd. Balance of Chair = $1\frac{3}{4}$ yds.



Code LC2

<u>Model</u>	<u>COM Requirement</u>
3770	Seat Box Only = $\frac{3}{4}$ yd. Balance of Chair = $1\frac{3}{4}$ yds.



Code LC3

<u>Model</u>	<u>COM Requirement</u>
3770	Seat Cushion & Seat Box = $1\frac{1}{2}$ yds. Balance of Chair = $1\frac{1}{4}$ yds.



LEAFLETTE KIDS MODULAR

designed by david dahl



SIN #711-16

LOUNGE AND BENCH PRODUCT FEATURES:

- Each unit comes standard with four (4) 5¹/₂" high Beech wood or metal legs.
- All standard and custom wood finishes available on Beech.
- For custom finishes (to legs and/or tables), please add one-time upcharge of \$400 List per color per order.
- Metal legs available in #92 Polished Aluminum and the following finishes: #06 Charcoal Grey and #90 Metallic Silver.
- Non-skid glides available for hard surface floors. Please specify “-NS02B” after model number and add \$20 List per chair.
- Available individually or in modular combinations with connecting tables.
- Models can join together as is, or to reduce the amount of legs as well as provide a more permanent connection, a ganging leg option is also available.
- Maximum weight capacity of 500 lbs.
- Please refer to page 9 for two-tone upholstery examples, yardage requirements and pricing.
- All dimensions are nominal.

TABLE PRODUCT FEATURES:

- Five table options: 30-degree, 45-degree, 90-degree, in-line and end table.
- Tables manufactured in Maple, Walnut and White Oak.
- All standard and custom wood finishes available.
- For custom finishes (to tables and/or legs), please add one-time upcharge of \$400 List per color per order.
- Laminate and Corian tops available (veneer body as standard, finish must be specified).
- For laminate top and body, or Corian top with laminate body, please specify and contact Customer Service for pricing.
- For Corian tops, specify “-CO” next to model number and select color. Corian top is affixed to table surface increasing overall table height by ¹/₂". Please note that a ¹/₈" reveal will be present.
- Each unit comes standard with four (4) 5¹/₂" high Beech wood or metal legs.
- Metal legs available in #92 Polished Aluminum and the following finishes: #06 Charcoal Grey and #90 Metallic Silver.
- Non-skid glides available for hard surface floors. Please specify “-NS02B” after model number and add \$20 List per chair.
- Tables join together with all Leaflette lounge and bench models as well as adult counterparts.
- Models can join together as is, or to reduce the amount of legs as well as provide a more permanent connection, a ganging leg option is available.
- All dimensions are nominal.

CORIAN® COLORS:

Designer White
Linen
Rain Cloud
Witch Hazel

Corian® is a registered trademark of Dupont.

LEAFLETTE KIDS MODULAR

designed by david dahl



SIN #711-16

'BUDS' MODULAR BENCH PRODUCT FEATURES:

- Available in four shapes to enable straight or curved configurations.
- Each unit features 2" black laminate plinth base.
- Benches available individually or in modular combinations.
- Buds can be joined with other Leaf and Leaflette models but they cannot be affixed together (ganging connection not available).

MODULAR ARRANGEMENTS:

- Ganging leg connects two units together and reduces the overall quantity of legs.
- To specify, please refer to units with "-G" in the model number.
- **Note: Please include layout drawings or sketch with each order.**
- Field assembly required.

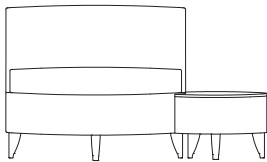

Standard Leg - Front View

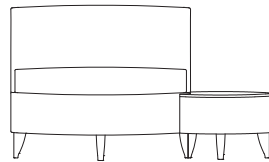

Ganging Leg - Front View

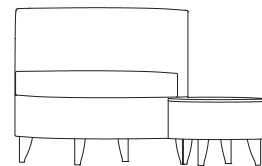
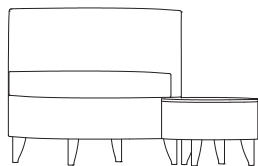

NOTES:

- Units available individually or in modular combinations with benches and tables (not ganged).
- For modular arrangements utilizing shared legs, please refer to models on page 5.
- Each unit comes standard with four (4) 5¹/₂" high Beech wood or metal legs.
- Refer to page 9 for two-tone upholstery examples and yardage requirements.

SPECIFY:

1. Model number
2. Leg finish
3. Upholstery selection
4. Options, as applicable

ORDERING EXAMPLE:

#3770-NS02B

Children's Lounge Chair
Non-Skid Glides

**LEAFLETTE
KIDS MODULAR**

designed by david dahl

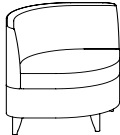
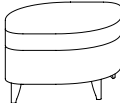
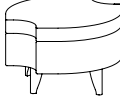
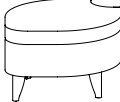
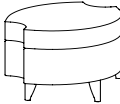
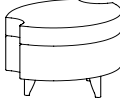

SIN #711-16

MODEL NUMBER	PRODUCT SPECIFICATIONS	FABRIC GRADES								LEATHER GRADES						
		COM	1	2	COL			4	5	6	7	8	L1	L2	L3	
3770 	Children's Lounge Chair W 28 ¹ / ₄ D 21 ¹ / ₂ H 24 ³ / ₄ Seat Height 15 Inside Seat Width 26 ¹ / ₄ Inside Seat Depth 17 ³ / ₄ 2 ¹ / ₂ Yds. 33 lbs. COL 50 Sq. Ft. TB 133, add \$120 List	1100	1242	1276	1337	1397	1455	1515	1570	1631	1906	2108	2305			
3771 	Children's Bench W 28 ¹ / ₄ D 21 ¹ / ₂ H 15 Seat Height 15 1 ¹ / ₂ Yds. 18 lbs. COL 30 Sq. Ft. TB 133, add \$72 List	915	1001	1021	1057	1093	1128	1164	1197	1234	1399	1520	1638			
3772 	Children's In-Line Bench W 23 ¹ / ₂ D 21 ¹ / ₂ H 15 Seat Height 15 1 ¹ / ₂ Yds. 17 lbs. COL 30 Sq. Ft. TB 133, add \$69 List	915	1001	1021	1057	1093	1128	1164	1197	1234	1399	1520	1638			
3773 	Children's In-Line/End Bench W 25 ³ / ₄ D 21 ¹ / ₂ H 15 Seat Height 15 1 ¹ / ₂ Yds. 18 lbs. COL 30 Sq. Ft. TB 133, add \$72 List	915	1001	1021	1057	1093	1128	1164	1197	1234	1399	1520	1638			
3774 	Children's 30-Degree Bench W 27 ¹ / ₄ D 21 ¹ / ₂ H 15 Seat Height 15 1 ¹ / ₂ Yds. 18 lbs. COL 30 Sq. Ft. TB 133, add \$72 List	937	1023	1043	1079	1115	1150	1186	1219	1256	1421	1542	1660			
3775 	Children's 45-Degree Bench W 27 ¹ / ₄ D 21 ¹ / ₂ H 15 Seat Height 15 1 ¹ / ₂ Yds. 18 lbs. COL 30 Sq. Ft. TB 133, add \$72 List	937	1023	1043	1079	1115	1150	1186	1219	1256	1421	1542	1660			

OPTIONS (XXXX - REFERS TO CHAIR MODEL NUMBER)

MODEL	DESCRIPTION	LIST
XXXX-NS02B	Non-Skid Glides	20

LEAFLETTE KIDS MODULAR

designed by david dahl



NOTES:

- Units available individually or in modular combinations with benches and tables (not ganged).
- For modular arrangements utilizing shared legs, please refer to models on page 6.
- Tables manufactured in Maple, Walnut and White Oak.
- For Corian tops, specify “-CO” next to model number and select color. Corian top is affixed to table surface increasing overall table height by 1/2" and features a 1/8" reveal .
- Each unit comes standard with four (4) 5 1/2" high Beech wood or metal legs.
- Tables connect with all lounge, bench and mid-size bench models as well as Leaf lounge and bench units.

SPECIFY:





1. Model number
2. Wood species
3. Wood finish
4. Leg finish
5. Options, as applicable

ORDERING EXAMPLE:

#3750-30-NS02B

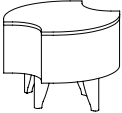
30-Degree Table
Non-Skid Glides

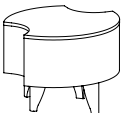
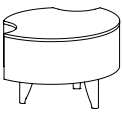
SIN #711-16

MODEL NUMBER	PRODUCT SPECIFICATIONS	TABLE TOP FINISH	
		VENEER OR LAMINATE	CORIAN (-CO)
3750 	In-Line Table W 16 ³ / ₄ D 16 ¹ / ₂ H 13 ¹ / ₄ 15 lbs.	928	1362
3750-30 	30-Degree Table W 18 ¹ / ₄ D 16 ¹ / ₂ H 13 ¹ / ₄ 15 lbs.	920	1355
3750-45 	45-Degree Table W 19 D 16 ³ / ₄ H 13 ¹ / ₄ 15 lbs.	928	1362
3750-90 	90-Degree Table W 23 D 19 H 13 ¹ / ₄ 15 lbs.	997	1623
3755 	In-Line/End Table W 19 D 16 ¹ / ₂ H 13 ¹ / ₄ 15 lbs.	937	1907

OPTIONS (XXXX - REFERS TO TABLE MODEL NUMBER)

MODEL	DESCRIPTION	LIST
XXXX-NS02B	Non-Skid Glides	20

NOTES:

- Models feature a shared ganging leg (-G) to connect units together.
- For stand-alone units (without ganging connector), please refer to models on page 3.
- Each unit comes standard with four (4) 5¹/₂" high Beech wood or metal legs.
- Refer to page 9 for two-tone upholstery examples and yardage requirements.

SPECIFY:

1. Model number
2. Leg finish
3. Upholstery selection
4. Options, as applicable

Please include layout drawings or sketch with each order.

ORDERING EXAMPLE:

#3770-G-NS02B

Children's Ganging Lounge Chair
Non-Skid Glides

**LEAFLETTE
KIDS MODULAR**

designed by david dahl

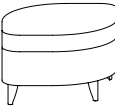
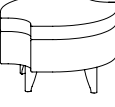
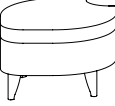
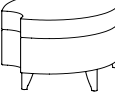
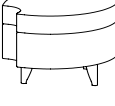

SIN #711-16

MODEL NUMBER	PRODUCT SPECIFICATIONS	FABRIC GRADES							LEATHER GRADES				
		COM	1	2	COL 3	4	5	6	7	8	L1	L2	L3
3770-G 	Children's Lounge Chair, Ganging W 28 ¹ / ₄ D 21 ¹ / ₂ H 24 ³ / ₄ Seat Height 15 Inside Seat Width 26 ¹ / ₄ Inside Seat Depth 17 ³ / ₄ 2 ¹ / ₂ Yds. 33 lbs. COL 50 Sq. Ft. TB 133, add \$120 List	1158	1300	1334	1395	1455	1513	1573	1628	1689	1964	2166	2363
3771-G 	Children's Bench, Ganging W 28 ¹ / ₄ D 21 ¹ / ₂ H 15 Seat Height 15 1 ¹ / ₂ Yds. 18 lbs. COL 30 Sq. Ft. TB 133, add \$72 List	972	1058	1078	1114	1150	1185	1221	1254	1291	1456	1577	1695
3772-G 	Children's In-Line Bench, Ganging W 23 ¹ / ₂ D 21 ¹ / ₂ H 15 Seat Height 15 1 ¹ / ₂ Yds. 18 lbs. COL 30 Sq. Ft. TB 133, add \$72 List	972	1058	1078	1114	1150	1185	1221	1254	1291	1456	1577	1695
3773-G 	Children's In-Line/End Bench, Ganging W 25 ³ / ₄ D 21 ¹ / ₂ H 15 Seat Height 15 1 ¹ / ₂ Yds. 18 lbs. COL 30 Sq. Ft. TB 133, add \$72 List	972	1058	1078	1114	1150	1185	1221	1254	1291	1456	1577	1695
3774-G 	Children's 30-Degree Bench, Ganging W 27 ¹ / ₄ D 21 ¹ / ₂ H 15 Seat Height 15 1 ¹ / ₂ Yds. 18 lbs. COL 30 Sq. Ft. TB 133, add \$72 List	994	1080	1100	1136	1172	1207	1243	1276	1313	1478	1599	1717
3775-G 	Children's 45-Degree Bench, Ganging W 27 ¹ / ₄ D 21 ¹ / ₂ H 15 Seat Height 15 1 ¹ / ₂ Yds. 18 lbs. COL 30 Sq. Ft. TB 133, add \$72 List	994	1080	1100	1136	1172	1207	1243	1276	1313	1478	1599	1717

OPTIONS (XXXX - REFERS TO CHAIR/BENCH MODEL NUMBER)

MODEL	DESCRIPTION	LIST
XXXX-NS02B	Non-Skid Glides	20

LEAFLETTE KIDS MODULAR

designed by david dahl



NOTES:

- Models feature a shared ganging leg (-G) to connect units together.
- For modular arrangements utilizing shared legs, please refer to models on page 4.
- Tables manufactured in Maple, Walnut and White Oak.
- For Corian tops, specify “-CO” next to model number and select color. Corian top is affixed to table surface increasing overall table height by 1/2" and features a 1/8" reveal.
- Each unit comes standard with four (4) 5 1/2" high Beech wood or metal legs.
- Tables connect with all lounge, bench and mid-size bench models as well as Leaf lounge and bench units.





SPECIFY:

1. Model number
2. Wood species
3. Wood finish
4. Leg finish
5. Options, as applicable

ORDERING EXAMPLE:

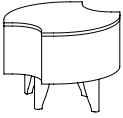
#3750-30-G-NS02B
Ganging 30-Degree Table
Non-Skid Glides

SIN #711-16

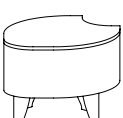
MODEL NUMBER	PRODUCT SPECIFICATIONS	TABLE TOP FINISH	
		VENEER OR LAMINATE	CORIAN (-CO)
3750-G 	In-Line Table, Ganging W 16 ³ / ₄ D 16 ¹ / ₂ H 13 ¹ / ₄ 15 lbs.	987	1424
3750-30-G 	30-Degree Table, Ganging W 18 ¹ / ₄ D 16 ¹ / ₂ H 13 ¹ / ₄ 15 lbs.	979	1414
3750-45-G 	45-Degree Table, Ganging W 19 D 16 ³ / ₄ H 13 ¹ / ₄ 15 lbs.	987	1424
3750-90-G 	90-Degree Table, Ganging W 23 D 19 H 13 ¹ / ₄ 15 lbs.	1056	1680
3755-G 	In-Line/End Table, Ganging W 19 D 16 ¹ / ₂ H 13 ¹ / ₄ 15 lbs.	996	1966

OPTIONS (XXXX - REFERS TO TABLE MODEL NUMBER)

MODEL	DESCRIPTION	LIST
XXXX-NS02B	Non-Skid Glides	20

NOTES:

- Units available individually or in modular combinations with other bud models.
- Each unit features 2" black laminate recessed plinth base.
- Buds can join with other Leaf and Leaflette models but they cannot be affixed together (ganging connection not available).
- Refer to page 9 for two-tone upholstery examples and yardage requirements.

SPECIFY:

1. Model number
2. Upholstery selection

ORDERING EXAMPLE:





#3781
In-Line Bench

LEAFLETTE
KIDS MODULAR

designed by david dahl



SIN #711-16

MODEL NUMBER	PRODUCT SPECIFICATIONS	FABRIC GRADES								LEATHER GRADES			
		COM	1	2	COL		4	5	6	7	8	L1	L2
3780	 <p>Buds Children's Bench, Plinth Base W 22¹/₄ D 17¹/₄ H 15 Seat Height 15 1¹/₄ Yds. 13 lbs. COL 25 Sq. Ft. TB 133, add \$60 List</p>	809	880	897	928	958	987	1017	1044	1075	1212	1313	1412
3781	 <p>Buds Children's In-Line Bench, Plinth Base W 18¹/₂ D 17¹/₂ H 15 Seat Height 15 1 Yd. 12 lbs. COL 20 Sq. Ft. TB 133, add \$48 List</p>	796	853	867	891	915	938	962	984	1009	1119	1200	1278
3782	 <p>Buds Children's In-Line/End Bench, Plinth Base W 19³/₄ D 17¹/₄ H 15 Seat Height 15 1 Yd. 12 lbs. COL 20 Sq. Ft. TB 133, add \$48 List</p>	796	853	867	891	915	938	962	984	1009	1119	1200	1278
3783	 <p>Buds Children's 45-Degree Bench, Plinth Base W 21¹/₂ D 17¹/₄ H 15 Seat Height 15 1 Yd. 12 lbs. COL 20 Sq. Ft. TB 133, add \$48 List</p>	796	853	867	891	915	938	962	984	1009	1119	1200	1278

LEAFLETTE KIDS MODULAR

designed by david dahl



SIN #711-16

CONFIGURATION AND ORDERING EXAMPLES

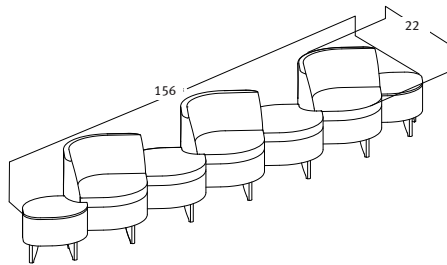

Qty	Model #	Description	COM List
3	3770-G	Lounge Chair (\$1,158 each)	3,474
2	3772-G	In-Line Benches (\$972 each)	1,944
2	3755-G	In-Line/End Tables (\$996 each)	1,992
7			7,410

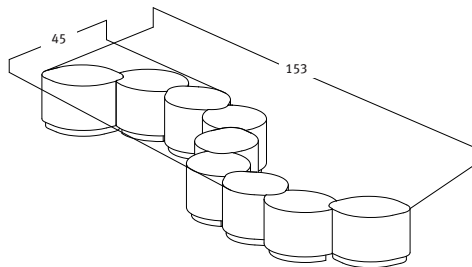

Qty	Model #	Description	COM List
5	3780	Buds Benches (\$809 each)	4,045
4	3783	Buds 45-Degree Benches (\$796)	3,184
9			7,229

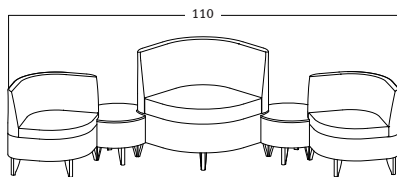

Qty	Model #	Description	COM List
2	3770-G	Lounge Chairs (\$1,158 each)	2,316
1	3700-G	Leaf Lounge Chair	1,343
2	3750-30-G	30-Degree Tables (\$979 each)	1,958
5			5,617

UPHOLSTERY COMBINATIONS:

For fabric, vinyl or leather upholstery combinations, refer to the pricing below:

- When combining **two** COM/COV/COL fabrics, or fabrics with the same grade, add \$65 List per unit.
- When combining **three or more** COM/COV/COL fabrics, or fabrics with the same grade, add \$75 List per unit.
- When combining different grades of fabric, price will be based on the highest grade specified.

- Two-tone upholstery examples and yardage requirements for the most common combinations are listed below. Additional combinations available, please contact Customer Service for yardage requirements and pricing.
- Note: Yardage amounts are based on fabric which is plain (i.e. non-directional) and a full 54" wide.
- **Appropriate upholstery code must be included on order.**

LEAFLETTE KIDS MODULAR

designed by david dahl



SIN #711-16



Code LC1

Model COM Requirement
3770 Seat Cushion Only = $\frac{3}{4}$ yd.
3770-G Balance of Chair = $1\frac{3}{4}$ yds.

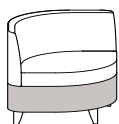

Code LC2

Model COM Requirement
3770 Seat Box Only = $\frac{3}{4}$ yd.
3770-G Balance of Chair = $1\frac{3}{4}$ yds.

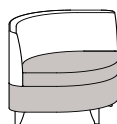

Code LC3

Model COM Requirement
3770 Seat Cushion & Seat Box = $1\frac{1}{2}$ yds.
3770-G Balance of Chair = $1\frac{1}{4}$ yds.



Code LC4

Model COM Requirement
3771 Seat Cushion = 1 yd.
3771-G Seat Box = $\frac{3}{4}$ yd.



Code LC5

Model COM Requirement
3772 Seat Cushion = 1 yd.
3772-G Seat Box = $\frac{3}{4}$ yd.



Code LC6

Model COM Requirement
3773 Seat Cushion = 1 yd.
3773-G Seat Box = $\frac{3}{4}$ yd.



Code LC7

Model COM Requirement
3771 Top of Seat Only = $\frac{3}{4}$ yd.
3771-G Balance of Bench = 1 yd.



Code LC8

Model COM Requirement
3772 Top of Seat Only = $\frac{3}{4}$ yd.
3772-G Balance of Bench = 1 yd.



Code LC9

Model COM Requirement
3773 Top of Seat Only = $\frac{3}{4}$ yd.
3773-G Balance of Bench = 1 yd.



Code LC10

Model COM Requirement
3780 Top of Seat Only = $\frac{3}{4}$ yd.
Balance of Bench = 1 yd.



Code LC11

Model COM Requirement
3781 Top of Seat Only = $\frac{3}{4}$ yd.
Balance of Bench = 1 yd.



Code LC12

Model COM Requirement
3782 Top of Seat Only = $\frac{3}{4}$ yd.
Balance of Bench = 1 yd.



Code LC13

Model COM Requirement
3783 Top of Seat Only = $\frac{3}{4}$ yd.
Balance of Bench = 1 yd.

LIVIA BENCHES

designed by christopher panichella



SIN #711-16

PRODUCT FEATURES:

- Straight and scalloped benches for indoor applications only.
- Available in Maple, Walnut and White Oak, in all standard and custom wood finishes on respective wood species.
- For custom wood finishes, please add one-time upcharge of \$400 List per color per order.
- Standard with black glides.
- Non-skid glide option available for hard-surface floors. Please specify “-NS10” after model number and add \$30 List per unit.
- Optional upholstered seat pad available on straight benches only.
- Seat pads ordered separately and are affixed to the unit with a metal bracket.
- Seat pads can be added in the field at a later time.
- Note: Although seat pads are removable, once installed, the wood properties beneath them will be affected differently than the exposed portions (i.e. light and aging). Therefore, removal is not recommended.
- Metal frame and spacers available in standard and premium finish selections.
- For premium metal finishes, please add \$110 List for 26", 48" and 60" length models and \$160 List for 72" length models.
- Unless specified, spacers will match metal frame finish as standard.
- Tamper-resistant floor mount hardware available.

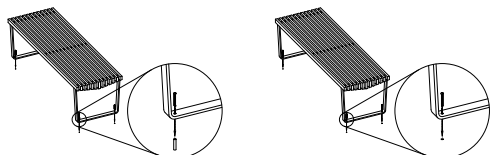

Floor Mount (-FM01) - Concrete Application Floor Mount (-FM02) - Wood Application

- Maximum weight capacity of 750 lbs. for 2- and 3-seat benches, and 350 lbs. for single-seat bench.

STANDARD FRAME FINISH COLORS:

- | | |
|---------------------|-----------------|
| #06 Charcoal Grey | #91 Chrome |
| #90 Metallic Silver | #95 Satin Black |

PREMIUM FRAME FINISH COLORS:

- | | |
|------------------|------------------------|
| #07 Gold Shimmer | #83 Metallic Champagne |
| #08 Penny | #94 Cotton |
| #09 Brown Sugar | |

LIVIA BENCHES

designed by christopher panichella



NOTES:

- Available in Maple, Walnut and White Oak.
- Refer to page 4 for optional seat pad (straight bench use only).

SPECIFY:

1. Model number
2. Wood species
3. Wood finish, as applicable
4. Frame finish
5. Options, as applicable

ORDERING EXAMPLE:

#8248-FM02
Straight Bench
Wood Floor Mount

SIN #711-16

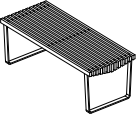
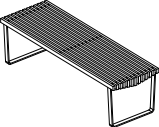
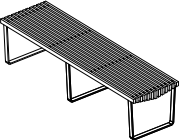
MODEL NUMBER	PRODUCT SPECIFICATIONS	WOOD SPECIES		
		MAPLE	WALNUT OR WHITE OAK	WEIGHT
8226 	26" Straight Bench W 26 D 20 H 17	1102	1332	45
8248 	48" Straight Bench W 48 D 20 H 17	1386	1682	57
8260 	60" Straight Bench W 60 D 20 H 17	1712	2085	64
8272 	72" Straight Bench W 72 D 20 H 17	2128	2569	78

OPTIONS (XXXX-REFERS TO BENCH MODEL NUMBER)

MODEL	DESCRIPTION	LIST
XXXX-NS10	Non-Skid Glides	30
XXXX-PF03	Premium Finish (26", 48" & 60" models)	110
XXXX-PF05	Premium Finish (72" models)	160
XXXX-FM01	Tamper-Resistant Concrete Floor Mount	204
XXXX-FM02	Tamper-Resistant Wood Floor Mount	204

NOTES:

- Available in Maple, Walnut and White Oak.
- Refer to page 4 for optional seat pad (straight bench use only).

SPECIFY:

1. Model number
2. Wood species
3. Wood finish, as applicable
4. Frame finish
5. Options, as applicable

ORDERING EXAMPLE:

#8273-PF05
 Scalloped Bench
 Premium Frame Finish

**LIVIA
 BENCHES**

designed by christopher panichella

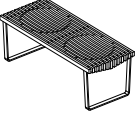
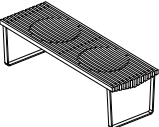
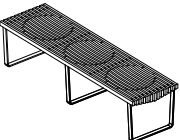

SIN #711-16

MODEL NUMBER	PRODUCT SPECIFICATIONS	WOOD SPECIES		
		MAPLE	WALNUT OR WHITE OAK	WEIGHT
8227 	26" Scalloped Bench W 26 D 20 H 17	1158	1388	44
8249 	48" Scalloped Bench W 48 D 20 H 17	1498	1793	56
8261 	60" Scalloped Bench W 60 D 20 H 17	1823	2196	63
8273 	72" Scalloped Bench W 72 D 20 H 17	2296	2736	77

OPTIONS (XXXX-REFERS TO BENCH MODEL NUMBER)

MODEL	DESCRIPTION	LIST
XXXX-NS10	Non-Skid Glides	30
XXXX-PF03	Premium Finish (26", 48" & 60" models)	110
XXXX-PF05	Premium Finish (72" models)	160
XXXX-FM01	Tamper-Resistant Concrete Floor Mount	204
XXXX-FM02	Tamper-Resistant Wood Floor Mount	204

LIVIA BENCHES

designed by christopher panichella



NOTES:

- Offered for use on straight bench models.
- Field replaceable.
- Please specify immediately following applicable bench unit.

SPECIFY:

1. Model number
2. Upholstery selection
3. Options, as applicable

ORDERING EXAMPLE:

#8260
Straight Bench
#82SP-MB01
Seat Pad
Moisture Barrier

SIN #711-16

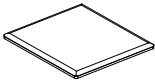
MODEL NUMBER	PRODUCT SPECIFICATIONS	FABRIC GRADES								LEATHER GRADES			
		COM	1	2	COL 3	4	5	6	7	8	L1	L2	L3
82SP	 <p>Seat Pad W 18 D 16 H 1¹/₄ ³/₄ yd. 1 lb. COL 15 Sq. Ft. TB 133, add \$36 List</p>	141	184	194	212	230	248	266	282	301	383	444	503

OPTIONS (XXXX - REFERS TO CHAIR MODEL NUMBER)

MODEL	DESCRIPTION	LIST
XXXX-MB01	Moisture Barrier	50

NOTES:

- Sled base manufactured in 1/2" diameter steel rod and comes standard with clear glides.
- 4-prong fixed pedestal base manufactured in aluminum. For auto-return feature, please specify "auto return".
- Maximum weight capacity is 350 lbs. for ottomans and 700 lbs. for bench model.
- Sled and pedestal bases available in standard and premium finish selections.

SPECIFY:

1. Model number
2. Base finish
3. Upholstery selection
4. Options, as applicable

ORDERING EXAMPLE:



#2580-NS11
 Bench
 Sled Base
 Non-Skid Glides

**NIOS®
 BENCHES**

designed by 5d studio

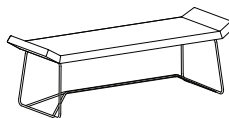

SIN #711-16

MODEL NUMBER	PRODUCT SPECIFICATIONS	FABRIC GRADES								LEATHER GRADES		
		COM	1	2	COL			7	8	L1	L2	L3
 2570 Ottoman, Sled Base W 28 D 20 ¹ / ₂ H 19 ¹ / ₂ Seat Height 16 1 Yd. 21 lbs. COL 20 Sq. Ft. TB 133, add \$48 List	981	1038	1052	1076	1100	1123	1147	1169	1194	1304	1385	1463
 2572 Ottoman, Fixed Pedestal Base W 28 D 20 ¹ / ₂ H 19 ¹ / ₂ Seat Height 16 1 Yd. 24 lbs. COL 20 Sq. Ft. TB 133, add \$48 List	1180	1237	1251	1275	1299	1322	1346	1368	1393	1503	1584	1662
 2580 Bench, Sled Base W 60 ¹ / ₂ D 20 ¹ / ₂ H 20 Seat Height 18 1 ¹ / ₂ Yds. 43 lbs. COL 30 Sq. Ft. TB 133, add \$72 List	1334	1420	1440	1476	1512	1547	1583	1616	1653	1818	1939	2057

Standard Frame Finishes:

- #06 Charcoal Grey
- #90 Metallic Silver
- #91 Chrome (sled base only)
- #92 Polished Aluminum (pedestal base only)
- #95 Satin Black

Premium Frame Finishes (add \$80 List):

- #07 Gold Shimmer
- #08 Penny
- #09 Brown Sugar
- #83 Metallic Champagne
- #94 Cotton

OPTIONS (XXXX - REFERS TO BENCH MODEL NUMBER)

MODEL	DESCRIPTION	LIST
XXXX-PF02	Premium Finish	80
XXXX-NS04	Non-Skid Glides, Pedestal Base	20
XXXX-NS11	Non-Skid Glides, Sled Base	20

NIOS[®] BENCHES

designed by 5d studio



SIN #711-16

UPHOLSTERY COMBINATIONS:

For fabric vinyl or leather upholstery combinations refer to the pricing below:

- When combining **two** COM/COV/COL fabrics or fabrics with the same grade price will be \$65 List (per unit).
- When combining **three or more** COM/COV/COL fabrics or fabrics with the same grade price will be \$75 List (per unit).
- When combining different grades of fabric price will be based on the highest grade specified.
- Two-tone upholstery examples and yardage requirements for the most common combinations are listed below. Additional combinations available please contact Customer Service for yardage requirements and pricing.
- Note: Yardage amounts are based on fabric which is plain (i.e. non-directional) and a full 54" wide.
- **Appropriate upholstery code must be included on order.**



Code NB1

<u>Models</u>	<u>COM Requirement</u>
2570	Top of Seat &
2572	Side Panels = $\frac{3}{4}$ yd. Balance of Ottoman = $\frac{1}{2}$ yd.



Code NB2

<u>Models</u>	<u>COM Requirement</u>
2570	Inside/Outside
2572	Side Panels = $\frac{3}{4}$ yd. Balance of Ottoman = $\frac{3}{4}$ yd.

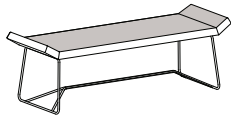

Code NB3

<u>Models</u>	<u>COM Requirement</u>
2580	Top of Seat & Side Panels = 1 yd. Balance of Bench = $\frac{1}{2}$ yd.

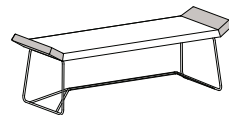

Code NB4

<u>Models</u>	<u>COM Requirement</u>
2580	Inside/Outside Side Panels = $\frac{3}{4}$ yd. Balance of Bench = 1 yd.

NOTES:

- Arm and armless models.
- Black leather arm caps standard on models with arms.
- Tubular metal arm and base available in #91 Chrome and all standard and premium finish colors. See below for options.
- Arm finish will match base finish unless otherwise specified.
- 300 lbs. maximum weight capacity.
- Refer to page 4 for two-tone upholstery examples and yardage requirements.

SPECIFY:

1. Model number
2. Metal leg finish
3. Arm finish, as applicable
4. Upholstery selection
5. Options, as applicable

ORDERING EXAMPLE:



#2535-PF01
 Armless Guest Chair
 Premium Finish

NIOS®
GUEST

designed by 5d studio



SIN #711-18

MODEL NUMBER	PRODUCT SPECIFICATIONS	FABRIC GRADES							LEATHER GRADES				
		COM	1	2	COL			8	L1	L2	L3		
2530	 <p>Guest Chair, Arms Metal Leg Base W 23³/₄ D 24 H 33 Seat Height 17¹/₂ Inside Seat Width 18 Inside Seat Depth 17¹/₂ Arm Height 26¹/₂ 1³/₄ Yds. 27 lbs. TB 133, add \$84 List</p>	1069	1169	1193	1235	1277	1318	1360	1398	1441	1634	1775	1913
2535	 <p>Q S Guest Chair, Armless Metal Leg Base W 22¹/₂ D 24 H 33 Seat Height 17¹/₂ Inside Seat Width 18 Inside Seat Depth 17¹/₂ 1³/₄ Yds. 21 lbs. TB 133, add \$84 List</p>	961	1061	1085	1127	1169	1210	1252	1290	1333	1526	1667	1805

Standard Finishes:
 #06 Charcoal Grey
 #90 Metallic Silver
 #91 Chrome
 #95 Satin Black

Premium Finishes:
 #07 Gold Shimmer
 #08 Penny
 #09 Brown Sugar
 #83 Metallic Champagne
 #94 Cotton

OPTIONS (XXXX - REFERS TO CHAIR MODEL NUMBER)

MODEL	DESCRIPTION	LIST
XXXX-PF01	Premium Finish, Armless Models	55
XXXX-PF02	Premium Finish, Arm Models	80
XXXX-NS05	Non-Skid Glides	20

Q S = Available on Quick-Ship Program (Chrome and Metallic Silver finishes only).

NIOS® GUEST

designed by 5d studio



SIN #711-18

NOTES:

- Arm and armless models.
- Black leather arm caps standard on models with arms.
- Tubular metal arm available in #91 Chrome and all standard and premium finish colors.
- 4-prong swivel pedestal base manufactured in aluminum with auto-return feature as standard.
- Pedestal base available in #92 Polished Aluminum and all standard and premium metal finishes.
- Arm finish will match base finish unless otherwise specified (base specified with #92 Polished Aluminum, arms will be #91 Chrome).
- 350 lbs. maximum weight capacity.



SPECIFY:

1. Model number
2. Base finish
3. Arm finish, as applicable
4. Upholstery selection
5. Options, as applicable

ORDERING EXAMPLE:

#2531-PF2

Guest Chair with Arms
Premium Base Finish

MODEL NUMBER	PRODUCT SPECIFICATIONS	FABRIC GRADES							LEATHER GRADES							
		COM	1	2	COL			3	4	5	6	7	8	L1	L2	L3
2531	 <p>Guest Chair, Arms Metal Swivel Base W 23³/₄ D 24 H 33¹/₄ Seat Height 17³/₄ Inside Seat Width 18 Inside Seat Depth 17¹/₂ Arm Height 26³/₄ 1³/₄ Yds. 33 lbs. TB 133, add \$84 List</p>	1283	1383	1407	1449	1491	1532	1574	1612	1655	1848	1989	2127			
2536	 <p>Guest Chair, Armless Metal Swivel Base W 22¹/₂ D 24 H 33¹/₄ Seat Height 17³/₄ Inside Seat Width 18 Inside Seat Depth 17¹/₂ 1³/₄ Yds. 27 lbs. TB 133, add \$84 List</p>	1174	1274	1298	1340	1382	1423	1465	1503	1546	1739	1880	2018			

Standard Finishes:
#06 Charcoal Grey
#90 Metallic Silver
#91 Chrome (arm only)
#92 Polished Aluminum (base only)
#95 Satin Black

Premium Finishes:
#07 Gold Shimmer
#08 Penny
#09 Brown Sugar
#83 Metallic Champagne
#94 Cotton

OPTIONS (XXXX - REFERS TO CHAIR MODEL NUMBER)

MODEL	DESCRIPTION	LIST
XXXX-PF01	Premium Finish, Armless Models	50
XXXX-PF02	Premium Finish, Arm Models	75
XXXX-NS04	Non-Skid Glides	20

NOTES:

- Arm and armless models.
- Black leather arm caps standard on models with arms.
- Tubular metal arm available in #91 Chrome and all standard and premium finish colors. See below for options.
- Wood legs available in Beech, Walnut and White Oak.
- All standard and custom wood finishes available.
- For custom wood finishes, please add \$400 List per color per order.
- 300 lbs. maximum weight capacity.

SPECIFY:

1. Model number
2. Wood leg species
3. Wood leg finish
4. Arm finish, as applicable
5. Upholstery selection
6. Options, as applicable

ORDERING EXAMPLE:

#2537-NS02B



Armless Guest Chair
Non-Skid Glides

NIOS®
GUEST

designed by 5d studio



SIN #711-18

MODEL NUMBER	PRODUCT SPECIFICATIONS	FABRIC GRADES								LEATHER GRADES				
		COM	1	2	COL			4	5	6	7	8	L1	L2
2532 	Guest Chair, Arms Wood Leg Base W 23 ³ / ₄ D 24 H 33 Seat Height 17 ¹ / ₂ Inside Seat Width 18 Inside Seat Depth 17 ¹ / ₂ Arm Height 26 ¹ / ₂ 1 ³ / ₄ Yds. 28 lbs. TB 133, add \$84 List	Beech	1142	1242	1266	1308	1350	1391	1433	1471	1514	1707	1848	1986
		White Oak and Walnut	1331	1431	1455	1497	1539	1580	1622	1660	1703	1896	2037	2175
2537 	Q S Guest Chair, Armless Wood Leg Base W 22 ¹ / ₂ D 24 H 33 Seat Height 17 ¹ / ₂ Inside Seat Width 18 Inside Seat Depth 17 ¹ / ₂ 1 ³ / ₄ Yds. 21 lbs. TB 133, add \$84 List	Beech	1038	1138	1162	1204	1246	1287	1329	1367	1410	1603	1744	1882
		White Oak and Walnut	1227	1327	1351	1393	1435	1476	1518	1556	1599	1792	1933	2071

Standard Finishes:
#06 Charcoal Grey
#90 Metallic Silver
#91 Chrome
#95 Satin Black

Premium Finishes:
#07 Gold Shimmer
#08 Penny
#09 Brown Sugar
#83 Metallic Champagne
#94 Cotton

OPTIONS (XXXX - REFERS TO CHAIR MODEL NUMBER)

MODEL	DESCRIPTION	LIST
XXXX-PF02	Premium Arm Finish	80
XXXX-NS02B	Non-Skid Glides	20

Q S = Available on Quick-Ship Program

NIOS® GUEST

designed by 5d studio



UPHOLSTERY COMBINATIONS:

For fabric, vinyl or leather upholstery combinations, refer to the pricing below:

- When combining **two** COM/COV/COL fabrics, or fabrics with the same grade, add \$45 List per unit.
- When combining **three or more** COM/COV/COL fabrics, or fabrics with the same grade, add \$55 List per unit.
- When combining different grades of fabric, price will be based on the highest grade specified.
- Two-tone upholstery examples and yardage requirements for the most common combinations are listed below. Additional combinations available, please contact Customer Service for yardage requirements and pricing.
- Note: Yardage amounts are based on fabric which is plain (i.e. non-directional) and a full 54" wide.
- **Appropriate upholstery code must be included on order.**

SIN #711-18



Code **NG1**
Models COM Requirement
 All Inside Back & Side
 Panels/Top of Seat = $\frac{3}{4}$ yd.
 Balance of Chair = 1 yd.

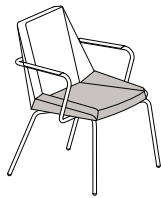

Code **NG2**
Models COM Requirement
 All Seat/Inside & Outside
 Lower Side Panels = $\frac{3}{4}$ yd.
 Balance of Chair = 1 yd.

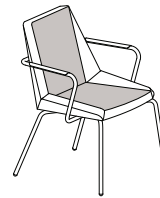

Code **NG3**
Models COM Requirement
 All Inside Back & Top of Seat = $\frac{3}{4}$ yd.
 Balance of Chair = $1\frac{1}{4}$ yd.

NIOS® LOUNGE

designed by 5d studio



SIN #711-16

METAL BASE PRODUCT FEATURES:

- Mid and high back models with swivel or sled base options.
- 4-prong swivel pedestal base manufactured in aluminum with auto-return feature as standard.
- Sled base manufactured in 1/2" diameter steel rod and comes standard with clear glides.
- Non-skid glide option for 4-leg, sled and pedestal bases available for hard-surface floors. Refer to individual product pages for specification information and upcharge.
- Sled and pedestal bases available in standard and premium finish selections. See below for options.
- For custom finish colors, please contact Customer Service for pricing.
- Metal accent featured between seat and back will match the base finish as standard, unless otherwise specified. For Polished Aluminum bases, metal accent will be Chrome (Polished Aluminum not available on metal accent piece).
- Optional under seat bookrack features 3" height clearance.
- Maximum weight capacity of 350 lbs. for sled base and 300 lbs. for swivel base models.
- Two-tone upholstery examples, yardage requirements and pricing featured on page 6.
- All dimensions are nominal.

STANDARD METAL BASE FINISH COLORS:

- #06 Charcoal Grey
- #90 Metallic Silver
- #91 Chrome (sled base only)
- #92 Polished Aluminum (swivel base only)
- #95 Satin Black

PREMIUM METAL BASE FINISH COLORS:

- #07 Gold Shimmer
- #08 Penny
- #09 Brown Sugar
- #83 Metallic Champagne
- #94 Cotton

WOOD BASE PRODUCT FEATURES:

- Mid and high back models with 4-leg wood base.
- 4-leg wood base offered in Beech, Walnut and White Oak.
- All standard and custom wood finishes available.
- For custom wood finishes, please add one-time upcharge of \$400 List per color per order.
- Non-skid glides available for hard-surface floors. Refer to individual product page for specification information and upcharge.
- Metal accent featured between seat and back will be Chrome as standard. For other standard finishes, please specify. Premium finishes also available.
- Maximum weight capacity of 300 lbs.
- Two-tone upholstery examples, yardage requirements and pricing featured on page 6.
- All dimensions are nominal.

ROTATING TABLET FEATURES:

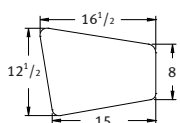

Tablet Shape

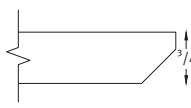

Veneer/Laminate Top - Edge Profile

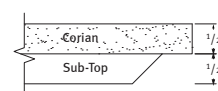

Corian Top - Edge Profile

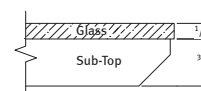

Back-Painted Glass Top - Edge Profile

- Tablets offered on sled and pedestal base models only.
- Tablet affixed to right or left side as specified.
- Tablet size is 16 1/2" W x 12 1/2" D x 3/4" thick with 270-degree tablet turning radius.

NIOS[®] LOUNGE

designed by 5d studio



SIN #711-16

ROTATING TABLET FEATURES CONTINUED:

- Four tablet surface options: veneer, laminate, Corian and back-painted glass.
- Tablet veneer surface offered in Maple, Walnut and White Oak, in all standard and custom wood finishes.
- For custom wood finishes, please add one-time upcharge of \$400 List per color per order.
- Laminate is applied to tablet top surface only.
- For standard laminates, refer to Standard Finish Card.
- For custom laminates, add \$500 List per color per order. Pre-approval required, please contact Customer Service.
- Corian available in four standard colors. For non-standard options, please contact Customer Service for pricing.
- Glass is back-painted white and may be used as a writable surface with dry-erase markers. For other colors, please contact Customer Service for pricing.
- For maximum durability, a laminate or Corian surface with a clear coat edge finish is recommended.
- Tablet mounting post will match chair base finish as standard, unless otherwise specified. For Polished Aluminum bases, post will be in Chrome (Polished Aluminum not available).

CORIAN® COLORS:

Designer White
Linen
Rain Cloud
Witch Hazel

Corian® is a registered trademark of Dupont.

TABLET EDGE FINISH SPECIFICATIONS:

- For veneer tops, edge finish will always match the top finish color, unless otherwise specified.
- For standard laminate tops (laminate cannot be applied to the edge):
 - › Wood grain laminates, edge finish will match the laminate top color, unless otherwise specified.
 - › Solid color laminates, edge finish will be natural (clear coat) as standard, unless otherwise specified.
- For Corian tops:
 - › Designer White, Rain Cloud and Linen colors, edge will be white as standard, unless otherwise specified.
 - › Witch Hazel, edge will be natural (clear coat) as standard, unless otherwise specified.
- Edges are also available in all standard wood finishes, please specify. For custom edge finishes, please add one-time upcharge of \$400 List per color, per order.

NOTES:

- Mid and high back models with sled or swivel base options.
- Sled base manufactured in 1/2" diameter steel rod and comes standard with clear glides.
- 4-prong swivel pedestal base manufactured in aluminum with auto-return feature as standard.
- Refer to page 6 for two-tone upholstery examples and yardage requirements.

SPECIFY:

1. Model number
2. Base finish
3. Upholstery selection
4. Options, as applicable

ORDERING EXAMPLE:

#2552-TAR13-CO-NS04



Mid-Back Lounge Chair with Swivel Base
Corian Tablet, Right
Non-Skid Glides

**NIOS®
LOUNGE**

designed by 5d studio



SIN #711-16

MODEL NUMBER	PRODUCT SPECIFICATIONS	FABRIC GRADES								LEATHER GRADES			
		COM	1	2	COL		5	6	7	8	L1	L2	L3
2551	 <p>Mid-Back Lounge Chair Sled Base W 33 D 31 1/2 H 32 Seat Height 16 3/4 Inside Seat Width 19 1/4 Inside Seat Depth 20 2 1/2 Yds. 35 lbs. COL 50 Sq. Ft. TB 133, add \$120 List</p>	1468	1610	1644	1705	1765	1823	1883	1938	1999	2274	2476	2673
		1716	1858	1892	1953	2013	2071	2131	2186	2247	2522	2724	2921
2552	 <p>Mid-Back Lounge Chair Swivel Pedestal Base W 33 D 31 1/2 H 32 Seat Height 16 3/4 Inside Seat Width 19 1/4 Inside Seat Depth 20 2 1/2 Yds. 38 lbs. COL 50 Sq. Ft. TB 133, add \$120 List</p>	1643	1785	1819	1880	1940	1998	2058	2113	2174	2449	2651	2848
		1643	1785	1819	1880	1940	1998	2058	2113	2174	2449	2651	2848
2553	 <p>Mid-Back Lounge Chair Sled Base, Book Rack W 33 D 31 1/2 H 32 Seat Height 16 3/4 Inside Seat Width 19 1/4 Inside Seat Depth 20 2 1/2 Yds. 39 lbs. COL 50 Sq. Ft. TB 133, add \$120 List</p>	1643	1785	1819	1880	1940	1998	2058	2113	2174	2449	2651	2848
		1643	1785	1819	1880	1940	1998	2058	2113	2174	2449	2651	2848

OPTIONS (XXXX - REFERS TO CHAIR MODEL NUMBER)

MODEL	DESCRIPTION	LIST
XXXX-TAR13	Veneer/Laminate Rotating Tablet, Right (as seated)	452
XXXX-TAL13	Veneer/Laminate Rotating Tablet, Left (as seated)	452
XXXX-TAR13-CO	Corian Rotating Tablet, Right (as seated)	754
XXXX-TAL13-CO	Corian Rotating Tablet, Left (as seated)	754
XXXX-TAR13-PG	Back-Painted Glass Rotating Tablet, Right (as seated)	610
XXXX-TAL13-PG	Back-Painted Glass Rotating Tablet, Left (as seated)	610
XXXX-NS04	Non-Skid Glides, Swivel Base	20
XXXX-NS11	Non-Skid Glides, Sled Base	20
XXXX-PF02	Premium Finish	80

NIOS[®] LOUNGE

designed by 5d studio



NOTES:

- Mid and high back models with sled or swivel base options.
- Sled base manufactured in 1/2" diameter steel rod and comes standard with clear glides.
- 4-prong swivel pedestal base manufactured in aluminum with auto-return feature as standard.
- Refer to page 6 for two-tone upholstery examples and yardage requirements.

SPECIFY:

1. Model number
2. Base finish
3. Upholstery selection
4. Options, as applicable

ORDERING EXAMPLE:

#2561-TAR13-PF02

High Back Lounge Chair with Sled Base
Veneer/Laminate Tablet, Right Premium Finish

SIN #711-16

MODEL NUMBER	PRODUCT SPECIFICATIONS	FABRIC GRADES							LEATHER GRADES				
		COM	1	2	COL 3	4	5	6	7	8	L1	L2	L3
2561	High Back Lounge Chair Sled Base W 33 D 31 1/2 H 41 Seat Height 16 3/4 Inside Seat Width 19 1/4 Inside Seat Depth 20 2 3/4 Yds. 39 lbs. COL 55 Sq. Ft. TB 133, add \$132 List	1584	1740	1778	1844	1911	1974	2041	2101	2168	2471	2693	2910
2562	High Back Lounge Chair Swivel Pedestal Base W 33 D 31 1/2 H 41 Seat Height 16 3/4 Inside Seat Width 19 1/4 Inside Seat Depth 20 2 3/4 Yds. 42 lbs. COL 55 Sq. Ft. TB 133, add \$132 List	1833	1989	2027	2093	2160	2223	2290	2350	2417	2720	2942	3159
2563	High Back Lounge Chair Sled Base, Book Rack W 33 D 31 1/2 H 41 Seat Height 16 3/4 Inside Seat Width 19 1/4 Inside Seat Depth 20 2 3/4 Yds. 43 lbs. COL 55 Sq. Ft. TB 133, add \$132 List	1758	1914	1952	2018	2085	2148	2215	2275	2342	2645	2867	3084

OPTIONS (XXXX - REFERS TO CHAIR MODEL NUMBER)

MODEL	DESCRIPTION	LIST
XXXX-TAR13	Veneer/Laminate Rotating Tablet, Right (as seated)	452
XXXX-TAL13	Veneer/Laminate Rotating Tablet, Left (as seated)	452
XXXX-TAR13-CO	Corian Rotating Tablet, Right (as seated)	754
XXXX-TAL13-CO	Corian Rotating Tablet, Left (as seated)	754
XXXX-TAR13-PG	Back-Painted Glass Rotating Tablet, Right (as seated)	610
XXXX-TAL13-PG	Back-Painted Glass Rotating Tablet, Left (as seated)	610
XXXX-NS04	Non-Skid Glides, Swivel Base	20
XXXX-NS11	Non-Skid Glides, Sled Base	20
XXXX-PF02	Premium Finish	80

NOTES:

- Wood legs available in Beech, Walnut and White Oak.
- All standard and custom wood finishes available.
- For custom wood finishes, please add \$400 List per color per order.
- Metal accent between seat and back will be Chrome as standard. For other standard finishes, please specify. Premium finishes also available.
- 300 lbs. maximum weight capacity.

SPECIFY:

1. Model number
2. Wood leg species
3. Wood leg finish
4. Upholstery selection
5. Options, as applicable

ORDERING EXAMPLE:

#2554-NS02B-PF01



Mid-Back Lounge Chair with
Wood Leg Base
Non-Skid Glides
Premium Finish

**NIOS®
LOUNGE**

designed by 5d studio



SIN #711-16

MODEL NUMBER	PRODUCT SPECIFICATIONS	FABRIC GRADES								LEATHER GRADES				
		COM	1	2	COL			7	8	L1	L2	L3		
2554 	Mid-Back Lounge Chair Wood Leg Base W 33 D 31 ¹ / ₂ H 32 Seat Height 17 Inside Seat Width 19 ¹ / ₄ Inside Seat Depth 20 2 ¹ / ₂ Yds. 40 lbs. COL 50 Sq. Ft. TB 133, add \$120 List	Beech	1524	1666	1700	1761	1821	1879	1939	1994	2055	2330	2532	2729
		White Oak and Walnut	1713	1855	1889	1950	2010	2068	2128	2183	2244	2519	2721	2918
2564 	High Back Lounge Chair Wood Leg Base W 33 D 31 ¹ / ₂ H 41 Seat Height 17 Inside Seat Width 19 ¹ / ₄ Inside Seat Depth 20 2 ³ / ₄ Yds. 44 lbs. COL 55 Sq. Ft. TB 133, add \$132 List	Beech	1655	1811	1849	1915	1982	2045	2112	2172	2239	2542	2764	2981
		White Oak and Walnut	1844	2000	2038	2104	2171	2234	2301	2361	2428	2731	2953	3170

OPTIONS (XXXX - REFERS TO CHAIR MODEL NUMBER)

MODEL	DESCRIPTION	LIST
XXXX-NS02B	Non-Skid Glides	20
XXXX-PF01	Premium Accent Finish	55

NIOS[®] LOUNGE

designed by 5d studio



NOTES:

- Sled base manufactured in 1/2" diameter steel rod and comes standard with clear glides.
- 4-prong fixed pedestal base manufactured in aluminum. For auto-return feature, please specify "auto return".
- 350 lbs. maximum weight capacity.
- Refer to page 6 for two-tone upholstery examples and yardage requirements.



SPECIFY:

1. Model number
2. Base finish
3. Upholstery selection
4. Options, as applicable

ORDERING EXAMPLE:

#2570-NS11
Ottoman, Sled Base
Non-Skid Glides

SIN #711-16

MODEL NUMBER	PRODUCT SPECIFICATIONS	FABRIC GRADES								LEATHER GRADES			
		COM	1	2	COL			6	7	8	L1	L2	L3
2570 	Ottoman, Sled Base W 28 D 20 ¹ / ₂ H 19 ¹ / ₂ Seat Height 16 1 Yd. 21 lbs. COL 20 Sq. Ft. TB 133, add \$48 List	981	1038	1052	1076	1100	1123	1147	1169	1194	1304	1385	1463
		1180	1237	1251	1275	1299	1322	1346	1368	1393	1503	1584	1662
2572 	Ottoman, Fixed Pedestal Base W 28 D 20 ¹ / ₂ H 19 ¹ / ₂ Seat Height 16 1 Yd. 24 lbs. COL 20 Sq. Ft. TB 133, add \$48 List	1180	1237	1251	1275	1299	1322	1346	1368	1393	1503	1584	1662
		1180	1237	1251	1275	1299	1322	1346	1368	1393	1503	1584	1662

OPTIONS (XXXX - REFERS TO OTTOMAN MODEL NUMBER)

MODEL	DESCRIPTION	LIST
XXXX-NS04	Non-Skid Glides, Swivel Base	20
XXXX-NS11	Non-Skid Glides, Sled Base	20
XXXX-PF02	Premium Finish	80

UPHOLSTERY COMBINATIONS:

For fabric, vinyl or leather upholstery combinations, refer to the pricing below:

- When combining **two** COM/COV/COL fabrics, or fabrics with the same grade, add \$65 List per unit.
- When combining **three or more** COM/COV/COL fabrics, or fabrics with the same grade, add \$75 List per unit.
- When combining different grades of fabric, price will be based on the highest grade specified.

- Two-tone upholstery examples and yardage requirements for the most common combinations are listed below. Additional combinations available, please contact Customer Service for yardage requirements and pricing.
- Note: Yardage amounts are based on fabric which is plain (i.e. non-directional) and a full 54" wide.
- **Appropriate upholstery code must be included on order.**

**NIOS®
LOUNGE**

designed by 5d studio



SIN #711-16



Code NL1

Models	COM Requirement
2551	Inside Back/Top of Seat = $\frac{3}{4}$ yds.
2552	Balance of Chair = 2 yds.
2553	
2554	



Code NL2

Models	COM Requirement
2551	Inside Back & Side Panels/Top of Seat = $1\frac{1}{2}$ yds.
2552	Balance of Chair = $1\frac{1}{4}$ yds.
2553	
2554	

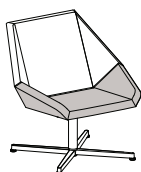

Code NL3

Models	COM Requirement
2551	Seat/Inside & Outside Lower Side Panels = $1\frac{1}{2}$ yds.
2552	Balance of Chair = $1\frac{1}{4}$ yds.
2553	
2554	

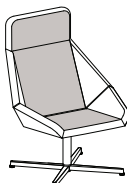

Code NL4

Models	COM Requirement
2561	Inside Headrest & Back/Top of Seat = 1 yd.
2562	Balance of Chair = 2 yds.
2563	
2564	

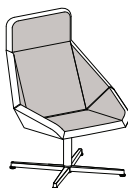

Code NL5

Models	COM Requirement
2561	Inside Headrest, Back & Side Panels/Top of Seat = $1\frac{1}{2}$ yds.
2562	Balance of Chair = $1\frac{1}{2}$ yds.
2563	
2564	

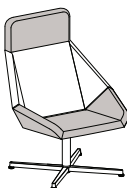

Code NL6

Models	COM Requirement
2561	Headrest/Seat/Inside & Outside Lower Side Panels = $1\frac{3}{4}$ yds.
2562	Balance of Chair = $1\frac{1}{2}$ yds.
2563	
2564	



Code NB1

Models	COM Requirement
2570	Top of Seat & Side Panels = $\frac{3}{4}$ yd.
2572	Balance of Ottoman = $\frac{1}{2}$ yd.



Code NB2

Models	COM Requirement
2570	Inside/Outside Side Panels = $\frac{3}{4}$ yd.
2572	Balance of Ottoman = $\frac{3}{4}$ yd.



NIOS® MEETING TABLES

designed by 5d studio

SIN #711-11

PRODUCT FEATURES:

- Round, arc square and arc rectangle top shapes.
- Three table heights: 26", 29" and 42".
- Custom heights between 26" - 42" available, please specify and add \$200 List upcharge per unit. Price is based on the higher standard table height (e.g. 32" custom height, price is based on the 42" standard height plus \$200).
- Table column diameter: 2¹/₄".
- Four table surface options: veneer, laminate, Corian or back-painted glass.
- Veneer offered in Maple, Walnut and White Oak wood species.
- All standard and custom wood finishes available.
- For custom wood finishes, please add one-time upcharge of \$400 List per color per order.
- Laminate tops available in all Arcadia standard laminates.
- For custom laminates, add \$500 List per color per order. Pre-approval required, please contact Customer Service.
- Unless specified, wood grain direction will run lengthwise on rectangle table sizes.
- Corian top available in four standard colors.
- Glass is back-painted white as standard and may be used as a writable surface with dry-erase markers.
- For non-standard Corian or back-painted glass colors, please contact Customer Service for pricing.
- Metal pedestal base manufactured in aluminum and offered in standard as well as premium finish selections.
- For custom finish colors, please contact Customer Service for pricing.
- Base standard with adjustable glides.
- Non-skid glide option available for hard-surface floors. Please specify "NS04" after model number and add \$20 List per unit.
- Base design facilitates wire management for through-the-surface electrical and/or data capability.
- All dimensions are nominal.

CORIAN® COLORS:

Designer White
Linen
Rain Cloud
Witch Hazel

Corian® is a registered trademark of Dupont.

STANDARD BASE FINISH COLORS:

#06 Charcoal Grey #92 Polished Aluminum
#90 Metallic Silver #95 Satin Black

PREMIUM BASE FINISH COLORS:

#07 Gold Shimmer #83 Metallic Champagne
#08 Penny #94 Cotton
#09 Brown Sugar

NIOS® MEETING TABLES

designed by 5d studio



SIN #711-11

EDGE FINISH SPECIFICATIONS:

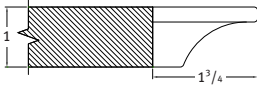

Veneer Top/Wood Edge

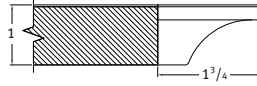

Laminate Top/Exposed Wood Edge

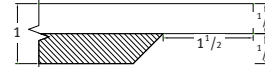

Corian Top/Exposed Wood Edge

- For veneer tops, edge finish will always match the top finish color, unless otherwise specified.
- For standard wood grain and solid color laminates, edge finish will always match the top finish color, unless specified (laminate cannot be applied to the edge).
- For Corian tops:
 - › Designer White, Rain Cloud and Linen colors, edge will be white as standard, unless otherwise specified.
 - › Witch Hazel, edge will be natural (clear coat) as standard, unless otherwise specified.
- Edges are also available in all standard wood finishes, please specify. For custom edge finishes, please add one-time upcharge of \$400 List per color, per order.

PORTAL POWER UNITS:

- Available on all table sizes and heights.
- Dimensions: 5 1/4" W x 4 1/4" L
- Touch latch lid provides easy access to data and electrical features.
- Satin nickel finish.

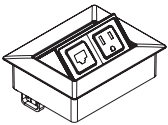

PP1

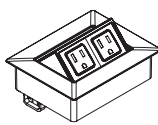

PP2

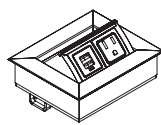

PP3

- PP1 unit features one simplex outlet with 72" electrical cord and one RJ-45 jack (Cat 6) with 72" patch cable.
- PP2 unit features two simplex outlets with 72" electrical cord.
- PP3 unit features one simplex outlet with 72" electrical cord and two USB charging ports.

NOTES:

- Three table heights: 26", 29" and 42".
- Four table surface options: veneer, laminate, Corian or back-painted glass.
- Veneer offered in Maple, Walnut and White Oak.
- Base available in all standard and premium metal finishes and comes standard with adjustable glides.

SPECIFY:

1. Model number
2. Wood species, as applicable
3. Table top finish
4. Edge finish, as applicable
5. Metal base finish
6. Options, as applicable

ORDERING EXAMPLE:

#251-303015-CO-NS04







30" Arc Square Table
Corian Top
Non-Skid Glides

NIOS[®]
MEETING TABLES

designed by 5d studio

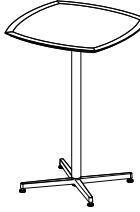

SIN #711-11

MODEL #	PRODUCT SPECIFICATIONS	TABLE TOP FINISH				
		MODEL NUMBER	VENEER OR LAMINATE	CORIAN (-CO)	BACK-PAINTED GLASS (-PG)	WEIGHT
251 	Square Top, 26" Height 251 Series Polished Aluminum & Standard Base Finishes	 251-303026	1493	2604	1957	35
		251-363626	1821	3418	2331	45
		251-424226	2081	4251	2648	56
	Square Top, 29" Height 251 Series Polished Aluminum & Standard Base Finishes	 251-303029	1520	2631	1983	36
		251-363629	1847	3446	2357	46
		251-424229	2110	4280	2678	57
	Square Top, 42" Height 251 Series Polished Aluminum & Standard Base Finishes	 251-303042	1604	2717	2068	39
		251-363642	1900	3499	2411	49

OPTIONS (XXXX - REFERS TO TABLE MODEL NUMBER)

MODEL	DESCRIPTION	LIST
XXXX-PF03	Premium Finish	110
XXXX-NS04	Non-Skid Glides	20
XXXX-PP1	Portal Power 1 (1 Power, 1 Data)	612
XXXX-PP2	Portal Power 2 (Dual Power)	542
XXXX-PP3	Portal Power 3 (1 Power, 2 USB)	643

Add \$65 List for electrical unit cut-out in glass top tables.

 = Available on Quick-Ship Program, models #251-303026, #251-363626, #251-303029, #251-363629, #251-303042, and #251-363642 (veneer, laminate and Corian top options with Chrome or Metallic Silver base finish).

NIOS® MEETING TABLES

designed by 5d studio



SIN #711-11

NOTES:

- Three table heights: 26", 29" and 42".
- Four table surface options: veneer, laminate, Corian or back-painted glass.
- Veneer offered in Maple, Walnut and White Oak.
- Base available in all standard and premium metal finishes and comes standard with adjustable glides.

SPECIFY:

1. Model number
2. Wood species, as applicable
3. Table top finish
4. Edge finish, as applicable
5. Metal base finish
6. Options, as applicable

ORDERING EXAMPLE:

#252-3029-PG-NS04

30" Round Table
Back-Painted Glass
Non-Skid Glides

MODEL #	PRODUCT SPECIFICATIONS	TABLE TOP FINISH				
		MODEL NUMBER	VENEER OR LAMINATE	CORIAN (-CO)	BACK-PAINTED GLASS (-PG)	WEIGHT
252 	Round Top, 26" Height 252 Series Polished Aluminum & Standard Base Finishes	252-3026	1643	2757	2134	35
		252-3626	2003	3601	2543	45
		252-4226	2289	4462	2887	56
	Round Top, 29" Height 252 Series Polished Aluminum & Standard Base Finishes	252-3029	1671	2785	2134	36
		252-3629	2033	3631	2543	46
		252-4229	2319	4493	2887	57
	Round Top, 42" Height 252 Series Polished Aluminum & Standard Base Finishes	252-3042	1766	2881	2229	39
		252-3642	2091	3691	2600	49

OPTIONS (XXXX - REFERS TO TABLE MODEL NUMBER)

MODEL	DESCRIPTION	LIST
XXXX-PF03	Premium Finish	110
XXXX-NS04	Non-Skid Glides	20
XXXX-PP1	Portal Power 1 (1 Power, 1 Data)	612
XXXX-PP2	Portal Power 2 (Dual Power)	542
XXXX-PP3	Portal Power 3 (1 Power, 2 USB)	643

Add \$65 List for electrical unit cut-out in glass top tables.



NIOS® OCCASIONAL TABLES

designed by 5d studio

SIN #711-11

PRODUCT FEATURES:

- Round, arc square and arc rectangle top shapes.
- Table column diameter: 2¹/₄".
- Four table surface options: veneer, laminate, Corian and back-painted glass.
- Veneer offered in Maple, Walnut and White Oak.
- All standard and custom wood finishes available. For custom wood finishes, please add one-time upcharge of \$400 List per color per order.
- Laminate tops available in all Arcadia standard laminates.
- For custom laminates, add \$500 List per color per order. Pre-approval required, please contact Customer Service.
- Unless specified, wood grain direction will run lengthwise on rectangle table sizes.
- Corian top available in four standard colors.
- Glass is back-painted white as standard and may be used as a writable surface with dry-erase markers.
- For non-standard Corian or back-painted glass colors, please contact Customer Service for pricing.
- Metal pedestal base manufactured in aluminum and offered in standard as well as premium finish selections.
- For custom finish colors, please contact Customer Service for pricing.
- Base standard with adjustable glides.
- Non-skid glide option available for hard-surface floors. Please specify "-NS04" after model number and add \$20 List per unit.
- Base design facilitates wire management for through-the-surface electrical and/or data capability.
- Custom heights below 15" available, please specify and add \$200 List upcharge per unit.

STANDARD BASE FINISH COLORS:

#06 Charcoal Grey	#92 Polished Aluminum
#90 Metallic Silver	#95 Satin Black

PREMIUM BASE FINISH COLORS:

#07 Gold Shimmer	#83 Metallic Champagne
#08 Penny	#94 Cotton
#09 Brown Sugar	

CORIAN® COLORS:

Designer White
Linen
Rain Cloud
Witch Hazel

Corian® is a registered trademark of Dupont.

NIOS®
OCCASIONAL TABLES
 designed by 5d studio



SIN #711-11

EDGE FINISH SPECIFICATIONS:

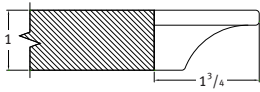

Veneer Top/Wood Edge

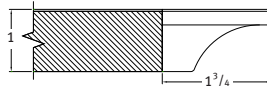

Laminate Top/Exposed Wood Edge

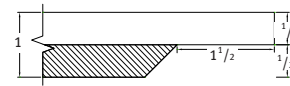

Corian Top/Exposed Wood Edge

- For veneer tops, edge finish will always match the top finish color, unless otherwise specified.
- For standard wood grain and solid color laminates, edge finish will always match the top finish color, unless specified (laminates cannot be applied to the edge).
- For Corian tops:
 - › Designer White, Rain Cloud and Linen colors, edge will be white as standard, unless otherwise specified.
 - › Witch Hazel, edge will be natural (clear coat) as standard, unless otherwise specified.
- Edges are also available in all standard wood finishes, please specify. For custom edge finishes, please add one-time upcharge of \$400 List per color, per order.

PORTAL POWER UNITS:

- Available on all table sizes and heights.
- Dimensions: 5 1/4" W x 4 1/4" L
- Touch latch lid provides easy access to data and electrical features.
- Satin nickel finish.

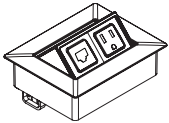

PP1

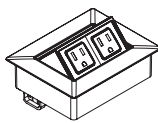

PP2

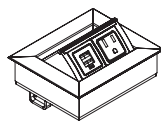

PP3

- PP1 unit features one simplex outlet with 72" electrical cord and one RJ-45 jack (Cat 6) with 72" patch cable.
- PP2 unit features two simplex outlets with 72" electrical cord.
- PP3 unit features one simplex outlet with 72" electrical cord and two USB charging ports.

NOTES:

- Four table surface options: veneer, laminate, Corian or back-painted glass.
- Veneer offered in Maple, Walnut and White Oak.
- Base available in all standard and premium metal finishes and comes standard with adjustable glides.

SPECIFY:

1. Model number
2. Wood species, as applicable
3. Table top finish
4. Edge finish, as applicable
5. Metal base finish
6. Options, as applicable

ORDERING EXAMPLE:

#251-303015-CO-NS04



30" Arc Square Table,
Corian Top
Non-Skid Glides

NIOS®
OCCASIONAL TABLES

designed by 5d studio

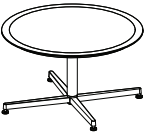

SIN #711-11

MODEL #	PRODUCT SPECIFICATIONS	TABLE TOP FINISH				
		MODEL NUMBER	VENEER OR LAMINATE	CORIAN (-CO)	BACK-PAINTED GLASS (-PG)	WEIGHT
251  	Arc Square/Rectangle, 15" High 251 Series Polished Aluminum & Standard Base Finishes Q S	251-202015	990	1486	1289	18
		251-242415	1099	1811	1505	24
		251-303015	1422	2534	1886	32
		251-363615	1750	3346	2258	42
		251-424215	2010	4182	2578	53
		251-422415	1392	2633	1855	35
		251-482815	1821	3477	2318	43
252 	Round, 15" High 252 Series Polished Aluminum & Standard Base Finishes	252-2015	1087	1587	1386	18
		252-2415	1209	1922	1615	24
		252-3015	1564	2678	2028	32
		252-3615	1924	3521	2433	42
		252-4215	2212	4384	2780	53

OPTIONS (XXXX - REFERS TO TABLE MODEL NUMBER)

MODEL	DESCRIPTION	LIST
XXXX-PF03	Premium Finish	110
XXXX-NS04	Non-Skid Glides	20
XXXX-PP1	Portal Power 1 (1 Power, 1 Data)	612
XXXX-PP2	Portal Power 2 (Dual Power)	542
XXXX-PP3	Portal Power 3 (1 Power, 2 USB)	643
XXXX-PC	Glass Top Electrical Unit Cut-Out	65

Q S = Available on Quick-Ship Program, models #251-202015, #251-242415, #251-303015 and #251-363615 (veneer, laminate and Corian tops with Chrome or Metallic Silver base finish).



OVATE® BENCHES

designed by christopher panichella



SIN #711-16

PRODUCT FEATURES:

- Fixed seat with low backrest and upholstered frame.
- Wood platform base available in Beech, Walnut and White Oak.
- All standard and custom wood finishes available.
- For custom wood finishes, please add one-time upcharge of \$400 List per color per order.
- Maximum weight capacity is 350 lbs. for single seat benches, 700 lbs. for two-seat models and 44" wide oval bench, and 1050 lbs. for three-seat and 56" wide oval bench models.
- Non-skid glides available for hard surface Floors. Please specify "-NS02B" after model number and add \$20 List per unit.
- **Select models available individually or in modular combinations with armless lounge models, tables and other bench units. Refer to Ovate Modular price list for more information.**
- Optional rotating tablet, stationary table-ette and power units available on benches with center table. Please refer to Ovate Modular price list for details.
- Tablet and table-ette mounting post will be positioned in the center of table as standard, unless specified otherwise.
- Mounting post standard with #91 Chrome finish. #90 Metallic Silver also available, please specify.
- Two-tone upholstery examples and yardage requirements featured on page 6.

OVATE[®] BENCHES

designed by christopher panichella



NOTES:

- Available individually or in modular combinations.
- Fixed seat with low backrest and upholstered frame.
- Wood platform base available in Beech, Walnut and White Oak.
- Two-tone upholstery examples and yardage requirements featured on page 6.

SPECIFY:

1. Model number
2. Wood base species
3. Wood base finish
4. Upholstery selection
5. Options, as applicable

ORDERING EXAMPLE:

#5322-NS02B
Two-Seat Bench, Low Backrest
Non-Skid Glides

SIN #711-16

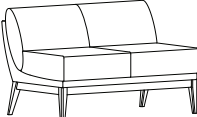
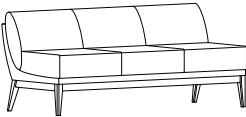
MODEL NUMBER	PRODUCT SPECIFICATIONS	FABRIC GRADES							LEATHER GRADES				
		COM	1	2	COL 3	4	5	6	7	8	L1	L2	L3
5321 	Single Seat Bench, Low Backrest W 22 ¹ / ₂ D 30 ¹ / ₄ H 29 ¹ / ₂ Seat Height 18 2 ¹ / ₂ Yds. 43 lbs. COL 50 Sq. Ft. TB 133, add \$120 List	1370	1512	1546	1607	1667	1725	1785	1840	1901	2176	2378	2575
5322 	Two-Seat Bench, Low Backrest W 44 ¹ / ₂ D 30 ¹ / ₄ H 29 ¹ / ₂ Seat Height 18 3 ³ / ₄ Yds. 66 lbs. COL 75 Sq. Ft. TB 133, add \$180 List	1817	2030	2081	2172	2262	2349	2440	2522	2613	3026	3329	3625
5323 	Three-Seat Bench, Low Backrest W 66 ¹ / ₂ D 30 ¹ / ₄ H 29 ¹ / ₂ Seat Height 18 5 Yds. 94 lbs. COL 100 Sq. Ft. TB 133, add \$240 List	2354	2638	2706	2827	2948	3063	3184	3294	3415	3966	4370	4764

OPTIONS (XXXX - REFERS TO BENCH MODEL NUMBER)

MODEL	DESCRIPTION	LIST
XXXX-NS02B	Non-Skid Glides	20

NOTES:

- Available individually or in modular combinations.
- Fixed seat with upholstered trim detail.
- Center table and wood platform base available in Beech, Walnut and White Oak.
- Two-tone upholstery examples and yardage requirements featured on page 6.

SPECIFY:

1. Model number
2. Wood base species
3. Wood base finish
4. Table finish, as applicable
5. Upholstery selection
6. Options, as applicable

ORDERING EXAMPLE:

#5332-T-TAC02-CO

Two-Seat Bench, Center Table
Corian Rotating Tablet

OVATE®
BENCHES

designed by christopher panichella

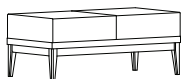
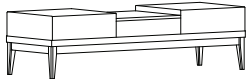
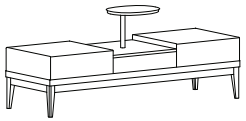
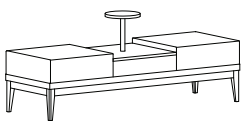
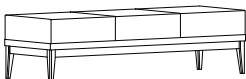

SIN #711-16

MODEL NUMBER	PRODUCT SPECIFICATIONS	FABRIC GRADES							LEATHER GRADES				
		COM	1	2	COL 3	4	5	6	7	8	L1	L2	L3
5332	 <p>Two-Seat Bench W 44¹/₄ D 22¹/₄ H 18 2¹/₄ Yds. 60 lbs. COL 45 Sq. Ft. TB 133, add \$108 List</p>	1468	1596	1627	1681	1735	1787	1842	1891	1946	2194	2376	2553
5332-T	 <p>Two-Seat Bench with Center Table W 68 D 22¹/₄ H 18 2¹/₄ Yds. 88 lbs. COL 45 Sq. Ft. TB 133, add \$108 List</p>	1877	2005	2036	2090	2144	2196	2251	2300	2355	2603	2785	2962
5332-T-TAC02	 <p>Two-Seat Bench with Center Table & Veneer or Laminate Rotating Tablet W 68 D 22¹/₄ H 18 2¹/₄ Yds. 90 lbs. COL 45 Sq. Ft. TB 133, add \$108 List</p>	2203	2331	2362	2416	2470	2522	2577	2626	2681	2929	3111	3288
5332-T-STC01	 <p>Two-Seat Bench with Center Table & Veneer or Laminate Stationary Table-ette W 68 D 22¹/₄ H 18 2¹/₄ Yds. 90 lbs. COL 45 Sq. Ft. TB 133, add \$108 List</p>	2181	2309	2340	2394	2448	2500	2555	2604	2659	2907	3089	3266
5333	 <p>Three-Seat Bench W 68 D 22¹/₄ H 18 3¹/₄ Yds. 88 lbs. COL 65 Sq. Ft. TB 133, add \$156 List</p>	2506	2634	2665	2719	2773	2825	2880	2929	2984	3232	3414	3591

OPTIONS - (XXXX-REFERS TO BENCH MODEL NUMBER)

MODEL	DESCRIPTION	LIST
XXXX-NS02B	Non-Skid Glides	20
XXXX-CO	Corian Rotating Tablet (add to #5332-T-TAC02)	629
XXXX-CO	Corian Stationary Table-ette (add to #5332-T-STC01)	472
XXXX-PB1-S	Power Band 1 (one power, two USB), Silver	413
XXXX-PB1-W	Power Band 1 (one power, two USB), White	413
XXXX-PB2-S	Power Band 2 (dual power), Silver	322
XXXX-PB2-W	Power Band 2 (dual power), White	322
XXXX-PB3-S	Power Band 3 (dual power, two USB), Silver	429
XXXX-PB3-W	Power Band 3 (dual power, two USB), White	429

OVATE[®] BENCHES

designed by christopher panichella



SIN #711-16

NOTES:

- Fixed seat cushion with upholstered trim detail.
- Wood platform base available in Beech, Walnut and White Oak.
- Two-tone upholstery examples and yardage requirements featured on page 7.



SPECIFY:

1. Model number
2. Wood base species
3. Wood base finish
4. Table finish, as applicable
5. Upholstery selection
6. Options, as applicable

ORDERING EXAMPLE:

#5343-T-STC01-CO

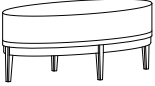
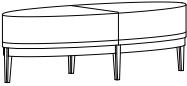
56" Wide Oval Bench
Corian Table-ette

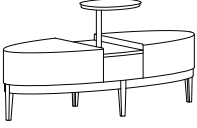
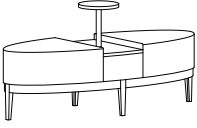
MODEL NUMBER	PRODUCT SPECIFICATIONS	FABRIC GRADES										LEATHER GRADES				
		COM	1	2	COL			4	5	6	7	8	L1	L2	L3	
5342 	44" Wide Oval Bench W 44 ¹ / ₂ D 22 ¹ / ₂ H 18 2 ¹ / ₄ Yds. 47 lbs. COL 45 Sq. Ft. TB 133, add \$108 List	1502	1630	1661	1715	1769	1821	1876	1925	1980	2228	2410	2587			
5343 	56" Wide Oval Bench W 57 D 24 ¹ / ₄ H 18 3 Yds. 64 lbs. COL 60 Sq. Ft. TB 133, add \$144 List	1700	1871	1912	1984	2056	2126	2198	2264	2337	2668	2910	3146			
5343-T 	56" Wide Oval Bench with Center Table W 57 D 24 ¹ / ₄ H 18 3 Yds. 64 lbs. COL 60 Sq. Ft. TB 133, add \$144 List	1939	2110	2151	2223	2295	2365	2437	2503	2576	2907	3149	3385			
5343-T-TAC02 	56" Wide Two-Seat Oval Bench, Center Table & Rotating Tablet W 57 D 24 ¹ / ₄ H 18 3 Yds. 66 lbs. COL 60 Sq. Ft. TB 133, add \$144 List	2265	2436	2477	2549	2621	2691	2763	2829	2902	3233	3475	3711			
5343-T-STC01 	56" Wide Two-Seat Oval Bench, Center Table & Stationary Table-ette W 57 D 24 ¹ / ₄ H 18 3 Yds. 66 lbs. COL 60 Sq. Ft. TB 133, add \$144 List	2243	2414	2455	2527	2599	2669	2741	2807	2880	3211	3453	3689			

OPTIONS - (XXXX-REFERS TO BENCH MODEL NUMBER)

MODEL	DESCRIPTION	LIST
XXXX-NS02B	Non-Skid Glides	20
XXXX-CO	Corian Rotating Tablet (add to #5343-T-TAC02)	629
XXXX-CO	Corian Stationary Table-ette (add to #5343-T-STC01)	472
XXXX-PB1-S	Power Band 1 (one power, two USB), Silver	413
XXXX-PB1-W	Power Band 1 (one power, two USB), White	413
XXXX-PB2-S	Power Band 2 (dual power), Silver	322
XXXX-PB2-W	Power Band 2 (dual power), White	322
XXXX-PB3-S	Power Band 3 (dual power, two USB), Silver	429
XXXX-PB3-W	Power Band 3 (dual power, two USB), White	429

NOTES:

- Fixed seat with upholstered trim detail.
- Wood platform base available in Beech, Walnut and White Oak.
- Two-tone upholstery examples and yardage requirements featured on page 7.

SPECIFY:

1. Model number
2. Wood base species
3. Wood base finish
4. Upholstery selection
5. Options, as applicable

ORDERING EXAMPLE:



#5361-NS02B
22" Square Bench
Non-Skid Glides

**OVATE®
BENCHES**

designed by christopher panichella

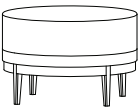
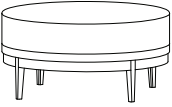

SIN #711-16

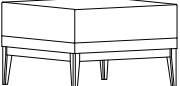
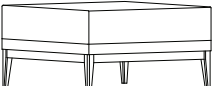
MODEL NUMBER	PRODUCT SPECIFICATIONS	FABRIC GRADES								LEATHER GRADES						
		COM	1	2	COL			4	5	6	7	8	L1	L2	L3	
5351 	22" Round Bench 22" Dia. x 18" H 1 1/2 Yds. 28 lbs. COL 30 Sq. Ft. TB 133, add \$72 List	1134	1220	1240	1276	1312	1347	1383	1416	1453	1618	1739	1857			
5352 	30" Round Bench 30" Dia. x 18" H 2 Yds. 42 lbs. COL 40 Sq. Ft. TB 133, add \$96 List	1380	1494	1521	1569	1618	1664	1712	1756	1805	2025	2187	2344			
5353 	36" Round Bench 36" Dia. x 18" H 3 Yds. 58 lbs. COL 60 Sq. Ft. TB 133, add \$144 List	1615	1786	1827	1899	1971	2041	2113	2179	2252	2583	2825	3061			
5361 	22" Square Bench W 22 D 22 1/4 H 18 1 1/4 Yds. 28 lbs. COL 25 Sq. Ft. TB 133, add \$60 List	1099	1170	1187	1218	1248	1277	1307	1334	1365	1502	1603	1702			
5362 	30" Square Bench W 30 1/4 D 30 1/4 H 18 2 3/4 Yds. 43 lbs. COL 55 Sq. Ft. TB 133, add \$132 List	1338	1494	1532	1598	1665	1728	1795	1855	1922	2225	2447	2664			
5363 	36" Square Bench W 36 1/4 D 36 1/4 H 18 3 Yds. 58 lbs. COL 60 Sq. Ft. TB 133, add \$144 List	1587	1758	1799	1871	1943	2013	2085	2151	2224	2555	2797	3033			

OPTIONS - (XXXX-REFERS TO BENCH MODEL NUMBER)

MODEL	DESCRIPTION	LIST	WEIGHT CAPACITY:
XXXX-NS02B	Non-Skid Glides	20	#5351 350 lbs. #5352 350 lbs. #5353 500 lbs. #5361 350 lbs. #5362 350 lbs. #5363 500 lbs.

OVATE[®] BENCHES

designed by christopher panichella



SIN #711-16

UPHOLSTERY COMBINATIONS:

For fabric, vinyl or leather upholstery combinations, refer to the pricing below:

- When combining **two** COM/COV/COL fabrics, or fabrics with the same grade, price will be \$65 List (per unit).
- When combining **three or more** COM/COV/COL fabrics, or fabrics with the same grade, price will be \$75 List (per unit).
- When combining different grades of fabric, price will be based on the highest grade specified.

- Two-tone upholstery examples and yardage requirements for the most common combinations are listed below. Additional combinations available, please contact Customer Service for yardage requirements and pricing.
- Note: Yardage amounts are based on fabric which is plain (i.e. non-directional) and a full 54" wide.
- **Appropriate upholstery code must be included on order.**



Code OV24
Model COM Requirement
5321 Upholstered Frame = 1 yd.
Balance of Bench = 1³/₄ yds.

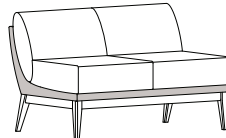

Code OV25
Model COM Requirement
5322 Upholstered Frame = 1¹/₄ yds.
Balance of Bench = 2³/₄ yds.

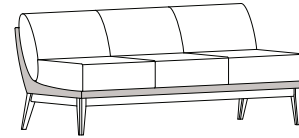

Code OV26
Model COM Requirement
5323 Upholstered Frame = 1³/₄ yds.
Balance of Bench = 3¹/₂ yds.

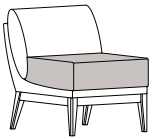

Code OV27
Model COM Requirement
5321 Seat Cushion Only = 1 yd.
Balance of Bench = 1³/₄ yds.

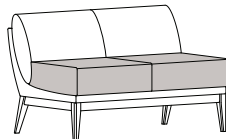

Code OV28
Model COM Requirement
5322 Seat Cushion Only = 1¹/₂ yds.
Balance of Bench = 2¹/₂ yds.

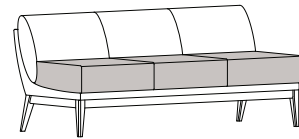

Code OV29
Model COM Requirement
5323 Seat Cushion Only = 2¹/₄ yds.
Balance of Bench = 3¹/₄ yds.



Code OV30
Model COM Requirement
5321 Back Cushion Only = 1 yd.
Balance of Bench = 1³/₄ yds.

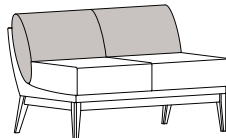

Code OV31
Model COM Requirement
5322 Back Cushion Only = 1¹/₂ yds.
Balance of Bench = 2¹/₂ yds.

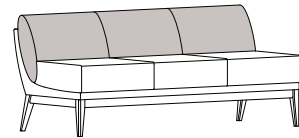

Code OV32
Model COM Requirement
5323 Back Cushion Only = 2 yds.
Balance of Bench = 3¹/₂ yds.

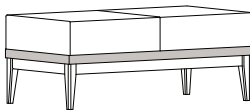

Code OV33
Model COM Requirement
5332 Upholstered Trim = 1/2 yd.
Balance of Bench = 1³/₄ yds.

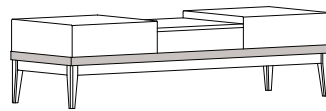

Code OV34
Model COM Requirement
5332-T Upholstered Trim = 3/4 yd.
Balance of Bench = 1³/₄ yds.

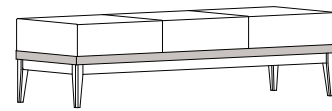

Code OV35
Model COM Requirement
5333 Upholstered Trim = 3/4 yd.
Balance of Bench = 2³/₄ yds.

UPHOLSTERY COMBINATIONS:

For fabric, vinyl or leather upholstery combinations, refer to the pricing below:

- When combining **two** COM/COV/COL fabrics, or fabrics with the same grade, price will be \$65 List (per unit).
- When combining **three or more** COM/COV/COL fabrics, or fabrics with the same grade, price will be \$75 List (per unit).
- When combining different grades of fabric, price will be based on the highest grade specified.

- Two-tone upholstery examples and yardage requirements for the most common combinations are listed below. Additional combinations available, please contact Customer Service for yardage requirements and pricing.
- Note: Yardage amounts are based on fabric which is plain (i.e. non-directional) and a full 54" wide.
- **Appropriate upholstery code must be included on order.**

**OVATE®
BENCHES**

designed by christopher panichella



SIN #711-16

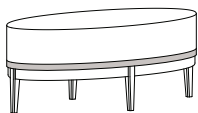

Code OV42
Model COM Requirement
5342 Upholstered Trim = $\frac{3}{4}$ yd.
Balance of Bench = $1\frac{1}{2}$ yds.

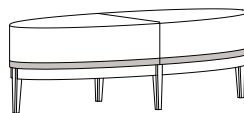

Code OV43
Model COM Requirement
5343 Upholstered Trim = $\frac{3}{4}$ yd.
Balance of Bench = $2\frac{1}{4}$ yds.

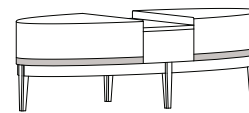

Code OV44
Model COM Requirement
5343-T Upholstered Trim = $\frac{3}{4}$ yd.
Balance of Bench = $2\frac{1}{4}$ yds.



Code OV45
Model COM Requirement
5351 Upholstered Trim = $\frac{1}{2}$ yd.
Balance of Bench = $1\frac{1}{4}$ yds.

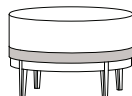

Code OV46
Model COM Requirement
5352 Upholstered Trim = $\frac{1}{2}$ yd.
Balance of Bench = $1\frac{1}{2}$ yds.

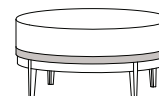

Code OV47
Model COM Requirement
5353 Upholstered Trim = $\frac{3}{4}$ yd.
Balance of Bench = $2\frac{1}{4}$ yds.



Code OV22
Model COM Requirement
5361 Upholstered Trim = $\frac{1}{2}$ yd.
Balance of Bench = 1 yd.



Code OV48
Model COM Requirement
5362 Upholstered Trim = $\frac{3}{4}$ yd.
Balance of Bench = 2 yds.



Code OV49
Model COM Requirement
5363 Upholstered Trim = $\frac{3}{4}$ yd.
Balance of Bench = $2\frac{1}{4}$ yds.

NOTES:

- Fixed seat and back.
- Wood platform base available in Beech, Walnut and White Oak, in all standard and custom wood finishes.
- For custom wood finishes, please add one-time upcharge of \$400 List per color per order.
- Platform base features 7" height clearance for floor maintenance ease.
- Maximum weight capacity is 350 lbs. for lounge chairs, 700 lbs. for love seats and 1000 lbs. for sofas.
- Refer to page 3 for two-tone upholstery examples and yardage requirements.

SPECIFY:

1. Model number
2. Wood base species
3. Wood base finish
4. Upholstery selection
5. Options, as applicable

ORDERING EXAMPLE:

#5301-NS02B

Lounge Chair
Non-Skid Glides

**OVATE®
LOUNGE**

designed by christopher panichella

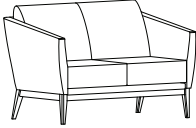
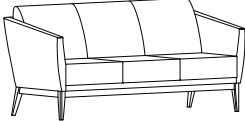

SIN #711-16

MODEL NUMBER	PRODUCT SPECIFICATIONS	FABRIC GRADES								LEATHER GRADES			
		COM	1	2	COL			7	8	L1	L2	L3	
5301	 <p>Lounge Chair W 30 D 31¹/₄ H 35¹/₂ Seat Height 18 Inside Seat Width 23 Inside Seat Depth 19¹/₂ Arm Height 29 5 Yds. 67 lbs. COL 100 Sq. Ft. TB 133, add \$240 List</p>	1582	1866	1934	2055	2176	2291	2412	2522	2643	3194	3598	3992
5302	 <p>Love Seat W 52 D 31¹/₄ H 35¹/₂ Seat Height 18 Inside Seat Width 45 Inside Seat Depth 19¹/₂ Arm Height 29 6¹/₂ Yds. 100 lbs. COL 130 Sq. Ft. TB 133, add \$312 List</p>	2163	2532	2621	2778	2935	3085	3242	3385	3542	4259	4784	5296
5303	 <p>Sofa W 74 D 31¹/₄ H 35¹/₂ Seat Height 18 Inside Seat Width 67 Inside Seat Depth 19¹/₂ Arm Height 29 7³/₄ Yds. 133 lbs. COL 155 Sq. Ft. TB 133, add \$372 List</p>	2870	3310	3416	3603	3790	3969	4156	4327	4514	5369	5995	6606

OPTIONS (XXXX - REFERS TO CHAIR MODEL NUMBER)

MODEL	DESCRIPTION	LIST
XXXX-NS02B	Non-Skid Glides	20

OVATE[®] LOUNGE

designed by christopher panichella



SIN #711-16

NOTES:

- Fixed seat and back with upholstered frame.
- Wood platform base available in Beech, Walnut and White Oak, in all standard and custom wood finishes.
- For custom wood finishes, please add one-time upcharge of \$400 List per color per order.
- Platform base features 7" height clearance for floor maintenance ease.
- Maximum weight capacity is 350 lbs. for lounge chairs, 700 lbs. for love seats and 1000 lbs. for sofas.
- Refer to page 4 for two-tone upholstery examples and yardage requirements.

SPECIFY:

1. Model number
2. Wood base species
3. Wood base finish
4. Upholstery selection
5. Options, as applicable

ORDERING EXAMPLE:

#5312-NS02B
Armless Love Seat
Non-Skid Glides

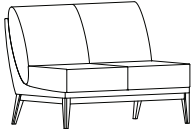
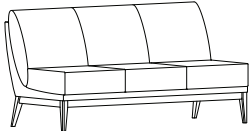
MODEL NUMBER	PRODUCT SPECIFICATIONS	FABRIC GRADES							LEATHER GRADES				
		COM	1	2	COL			8	L1	L2	L3		
5311	 <p>Armless Lounge Chair W 22¹/₂ D 31¹/₄ H 35¹/₂ Seat Height 18 Inside Seat Width 22¹/₂ Inside Seat Depth 19¹/₂ 3 Yds. 43 lbs. COL 60 Sq. Ft. TB 133, add \$144 List</p>	1385	1556	1597	1669	1741	1811	1883	1949	2022	2353	2595	2831
5312	 <p>Armless Love Seat W 44¹/₂ D 31¹/₄ H 35¹/₂ Seat Height 18 Inside Seat Width 44¹/₂ Inside Seat Depth 19¹/₂ 4¹/₂ Yds. 75 lbs. COL 90 Sq. Ft. TB 133, add \$216 List</p>	1988	2244	2305	2414	2522	2626	2735	2834	2943	3439	3803	4157
5313	 <p>Armless Sofa W 66¹/₂ D 31¹/₄ H 35¹/₂ Seat Height 18 Inside Seat Width 66¹/₂ Inside Seat Depth 19¹/₂ 5³/₄ Yds. 108 lbs. COL 115 Sq. Ft. TB 133, add \$276 List</p>	2681	3008	3086	3225	3364	3497	3635	3762	3901	4535	5000	5453

OPTIONS (XXXX - REFERS TO CHAIR MODEL NUMBER)

MODEL	DESCRIPTION	LIST
XXXX-NS02B	Non-Skid Glides	20

UPHOLSTERY COMBINATIONS:

For fabric, vinyl or leather upholstery combinations, refer to the pricing below:

- When combining **two** COM/COV/COL fabrics, or fabrics with the same grade, add the following (per unit):
 - › \$65 List for lounge chairs
 - › \$105 List for love seats
 - › \$130 List for sofas
- When combining **three or more** COM/COV/COL fabrics, or fabrics with the same grade, add the following (per unit):
 - › \$75 List for lounge chairs
 - › \$115 List for love seats
 - › \$140 List for sofas
- When combining different grades of fabric, price will be based on the highest grade specified.
- Two-tone upholstery examples and yardage requirements for the most common combinations are listed below. Additional combinations available, please contact Customer Service for yardage requirements and pricing.
- Note: Yardage amounts are based on fabric which is plain (i.e. non-directional) and a full 54" wide.
- **Appropriate upholstery code must be included on order.**

OVATE®
LOUNGE

designed by christopher panichella



SIN #711-16

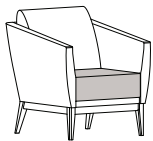

Code OV1
Model COM Requirement
5301 Seat Cushion Only = 1 yd.
Balance of Chair = 4³/₄ yds.

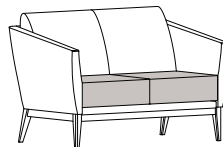

Code OV2
Model COM Requirement
5302 Seat Cushion Only = 1¹/₂ yds.
Balance of Chair = 5¹/₂ yds.

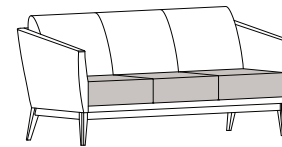

Code OV3
Model COM Requirement
5303 Seat Cushion Only = 2 yds.
Balance of Chair = 6¹/₂ yds.

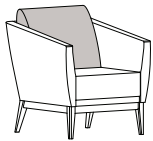

Code OV4
Model COM Requirement
5301 Back Cushion Only = 1¹/₄ yds.
Balance of Chair = 4¹/₂ yds.

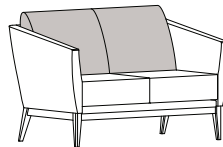

Code OV5
Model COM Requirement
5302 Back Cushion Only = 2 yds.
Balance of Chair = 5¹/₄ yds.

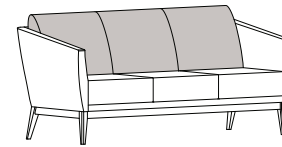

Code OV6
Model COM Requirement
5303 Back Cushion Only = 2¹/₂ yds.
Balance of Chair = 6¹/₄ yds.

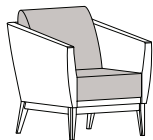

Code OV7
Model COM Requirement
5301 Back/Seat Cushion Only = 1³/₄ yds.
Balance of Chair = 3³/₄ yds.

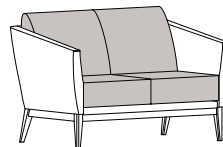

Code OV8
Model COM Requirement
5302 Back/Seat Cushion Only = 3 yds.
Balance of Chair = 4¹/₂ yds.

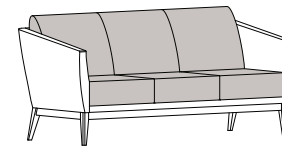

Code OV9
Model COM Requirement
5303 Back/Seat Cushion Only = 4 yds.
Balance of Chair = 4³/₄ yds.

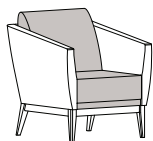

Code OV10
Model COM Requirement
5301 Back/Seat Cushion/Trim = 2 yds.
Balance of Chair = 3³/₄ yds.

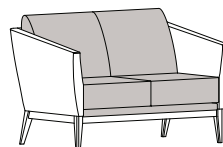

Code OV11
Model COM Requirement
5302 Back/Seat Cushion/Trim = 3 yds.
Balance of Chair = 4¹/₂ yds.

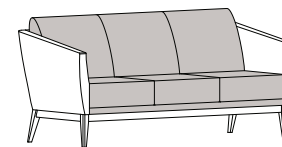

Code OV12
Model COM Requirement
5303 Back/Seat Cushion/Trim = 4¹/₄ yds.
Balance of Chair = 4³/₄ yds.

OVATE[®] LOUNGE

designed by christopher panichella



UPHOLSTERY COMBINATIONS:

For fabric, vinyl or leather upholstery combinations, refer to the pricing below:

- When combining **two** COM/COV/COL fabrics, or fabrics with the same grade, add the following (per unit):
 - › \$65 List for lounge chairs
 - › \$105 List for love seats
 - › \$130 List for sofas
- When combining **three or more** COM/COV/COL fabrics, or fabrics with the same grade, add the following (per unit):
 - › \$75 List for lounge chairs
 - › \$115 List for love seats
 - › \$140 List for sofas

- When combining different grades of fabric, price will be based on the highest grade specified.
- Two-tone upholstery examples and yardage requirements for the most common combinations are listed below. Additional combinations available, please contact Customer Service for yardage requirements and pricing.
- Note: Yardage amounts are based on fabric which is plain (i.e. non-directional) and a full 54" wide.
- **Appropriate upholstery code must be included on order.**

SIN #711-16



Code OV13

Model COM Requirement
5311 Upholstered Frame = 1¹/₄ yds.
Balance of Chair = 1³/₄ yds.

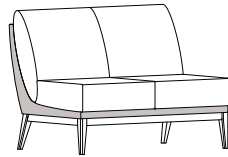

Code OV14

Model COM Requirement
5312 Upholstered Frame = 1¹/₂ yds.
Balance of Chair = 3 yds.

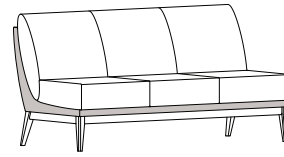

Code OV15

Model COM Requirement
5313 Upholstered Frame = 2 yds.
Balance of Chair = 4 yds.



Code OV16

Model COM Requirement
5311 Seat Cushion Only = 1 yd.
Balance of Chair = 2¹/₄ yds.

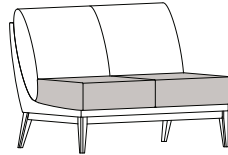

Code OV17

Model COM Requirement
5312 Seat Cushion Only = 1¹/₂ yds.
Balance of Chair = 3 yds.

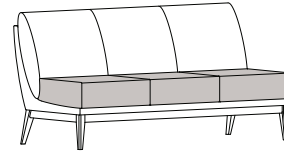

Code OV18

Model COM Requirement
5313 Seat Cushion Only = 2 yds.
Balance of Chair = 4 yds.

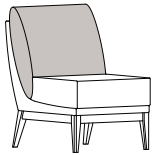

Code OV19

Model COM Requirement
5311 Back Cushion Only = 1¹/₄ yds.
Balance of Chair = 2 yds.

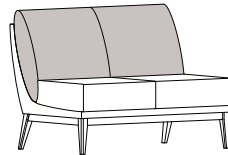

Code OV20

Model COM Requirement
5312 Back Cushion Only = 2 yds.
Balance of Chair = 3 yds.

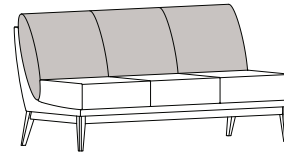

Code OV21

Model COM Requirement
5313 Back Cushion Only = 2¹/₂ yds.
Balance of Chair = 4 yds.



OVATE® MODULAR

designed by christopher panichella



SIN #711-16

LOUNGE CHAIR PRODUCT FEATURES:

- Armless lounge chair, love seat and sofa models available individually or in modular combinations with tables and benches.
- Fixed seat and back.
- Wood platform base available in Beech, Walnut and White Oak.
- All standard and custom wood finishes available.
- For custom wood finishes (to base, tables and/or tablets), please add one-time upcharge of \$400 List per color per order.
- Platform base features 7" height clearance for floor maintenance ease.
- Non-skid glides available for hard surface floors. Please specify "-NS02B" after model number and add \$20 List per unit.
- Maximum weight capacity is 350 lbs. for lounge chairs, 700 lbs. for love seats and 1000 lbs. for sofas.
- Two-tone upholstery examples, yardage requirements and pricing featured on pages 11-12.
- All dimensions are nominal.

TABLE PRODUCT FEATURES:

- Available in 12" and 18" widths as well as quarter-round.
- Straight tables available in two heights: 16" and 24".
- Three table surface options: veneer, laminate or Corian.
- All standard and custom wood finishes available on Beech, Walnut and White Oak.
- For custom wood finishes (to base, tables and/or tablets), please add one-time upcharge of \$400 List per color per order.
- For standard laminates, refer to Standard Finish Card.
- For custom laminates, add \$500 List per color per order. Pre-approval required, please contact Customer Service.
- Corian top is affixed to table surface increasing overall table height by 1/2". Please note that a 1/8" reveal will be present.
- Corian top available in four standard colors. For non-standard colors, please contact Customer Service for pricing.
- **Table with laminate or Corian top, finish selection for table body must be specified.**
- All tables feature wood platform base with 7" height clearance.
- Platform base available in Beech, Walnut and White Oak.
- Platform base will match table body unless specified otherwise.
- Two tone finishing (table and platform base) available at no upcharge as long as within the same wood species.
- Non-skid glides available for hard surface floors. Please specify "-NS02B" after model number and add \$20 List per unit.
- All dimensions are nominal.

CORIAN® COLORS:

Designer White
Linen
Rain Cloud
Witch Hazel

Corian® is a registered trademark of Dupont.

OVATE[®] MODULAR

designed by christopher panichella



SIN #711-16

BENCH PRODUCT FEATURES:

- All benches feature upholstered trim detail and wood platform base with 7" height clearance.
- Base available in Beech, Walnut and White Oak.
- All standard and custom wood finishes available.
- For custom wood finishes (to base, tables and/or tablets), please add one-time upcharge of \$400 List per color per order.
- Non-skid glides available for hard surface floors. Please specify "-NS02B" after model number and add \$20 List per bench.
- **Note: Upholstery direction must be specified on quarter-round benches when patterned fabrics are selected. In the absence of specific instructions, Arcadia reserves the right to upholster units at our discretion.**
- All dimensions are nominal.

Up the roll

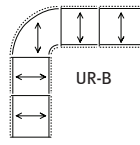
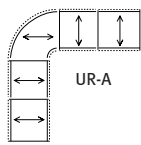

Railroaded

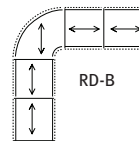
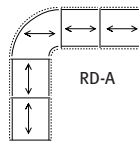

ROTATING TABLE/STATIONARY TABLE-ETTE:

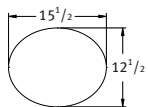

Rotating Tablet Shape

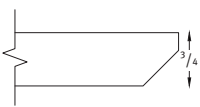

Veneer/Laminate Top - Edge Profile

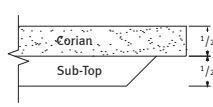

Corian Top - Edge Profile

- Available on 16" high tables only.
- Rotating tablet size is 15 1/2" W x 12 1/2" D x 3/4" thick with 360-degree turning radius.
- Stationary table-ette size is 10" dia. x 3/4" thick.
- Three surface options: veneer, laminate or Corian.
- Veneer offered in Beech, Walnut and White Oak, in all standard and custom wood finishes.
- For custom wood finishes (to base, tables and/or tablets), please add one-time upcharge of \$400 List per color per order.
- Laminate and Corian is applied to top surface only.
- For standard laminates, refer to Standard Finish Card.
- For custom laminates, add \$500 List per color per order. Pre-approval required, please contact Customer Service.
- Corian available in four standard colors each. For non-standard options, please contact Customer Service for pricing.
- For maximum durability, a laminate or Corian surface with a clear coat edge finish is recommended.
- Tablet mounting post standard with #91 Chrome finish. #90 Metallic Silver also available, please specify.



OVATE[®] MODULAR

designed by christopher panichella



SIN #711-16

TABLET/TABLE-ETTE EDGE FINISH SPECIFICATIONS:

- For veneer tops, edge finish will always match the top finish color, unless otherwise specified.
- For standard laminate tops (laminate cannot be applied to the edge):
 - › Wood grain laminates, edge finish will match the laminate top color, unless otherwise specified.
 - › Solid color laminates, edge finish will be natural (clear coat) as standard, unless otherwise specified.
- For Corian tops:
 - › Designer White, Rain Cloud and Linen colors, edge will be white as standard, unless otherwise specified.
 - › Witch Hazel, edge will be natural (clear coat) as standard, unless otherwise specified.
- Edges are also available in all standard wood finishes, please specify. For custom edge finishes, please add one-time upcharge of \$400 List per color, per order.

POWER UNITS:

- Available on all tables.
- PB1 and PB2 dimensions: 5³/₄" W x 2¹/₂" D
- PB3 dimensions: 6¹/₂" W x 2¹/₂" D
- Metallic Silver or White finish with 108" electrical cord.
- UL listed.



PB1

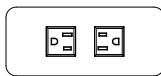

PB2



PB3

- PB1 unit features one outlet and two USB charging ports.
- PB2 unit features two outlets.
- PB3 unit features two outlets and two USB charging ports.

MODULAR ARRANGEMENTS:

- Optional ganging bracket available, please specify "GC04" with quantity and add \$75 List per set. One set contains two brackets for connecting two units together.
- Field assembly required.

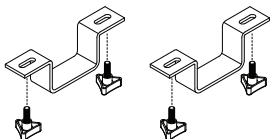

OVATE[®] MODULAR

designed by christopher panichella



NOTES:

- Fixed seat and back with upholstered frame.
- Wood platform base available in Beech, Walnut and White Oak.
- Available individually or in modular combinations with tables and benches.
- Refer to page 11 for two-tone upholstery examples and yardage requirements.

SPECIFY:

1. Model number
2. Wood base species
3. Wood base finish
4. Upholstery selection
5. Options, as applicable

ORDERING EXAMPLE:

#5312-NS02B
Armless Love Seat
Non-Skid Glides

SIN #711-16

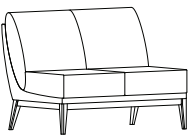
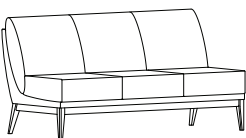
MODEL NUMBER	PRODUCT SPECIFICATIONS	FABRIC GRADES							LEATHER GRADES				
		COM	1	2	COL			8	L1	L2	L3		
5311 	Armless Lounge Chair W 22 ¹ / ₂ D 31 ¹ / ₄ H 35 ¹ / ₂ Seat Height 18 Inside Seat Width 22 ¹ / ₂ Inside Seat Depth 19 ¹ / ₂ 3 Yds. 43 lbs. COL 60 Sq. Ft. TB 133, add \$144 List	1385	1556	1597	1669	1741	1811	1883	1949	2022	2353	2595	2831
		1988	2244	2305	2414	2522	2626	2735	2834	2943	3439	3803	4157
5312 	Armless Love Seat W 44 ¹ / ₂ D 31 ¹ / ₄ H 35 ¹ / ₂ Seat Height 18 Inside Seat Width 44 ¹ / ₂ Inside Seat Depth 19 ¹ / ₂ 4 ¹ / ₂ Yds. 75 lbs. COL 90 Sq. Ft. TB 133, add \$216 List	2681	3008	3086	3225	3364	3497	3635	3762	3901	4535	5000	5453
		2681	3008	3086	3225	3364	3497	3635	3762	3901	4535	5000	5453
5313 	Armless Sofa W 66 ¹ / ₂ D 31 ¹ / ₄ H 35 ¹ / ₂ Seat Height 18 Inside Seat Width 66 ¹ / ₂ Inside Seat Depth 19 ¹ / ₂ 5 ³ / ₄ Yds. 108 lbs. COL 115 Sq. Ft. TB 133, add \$276 List	2681	3008	3086	3225	3364	3497	3635	3762	3901	4535	5000	5453
		2681	3008	3086	3225	3364	3497	3635	3762	3901	4535	5000	5453

OPTIONS (XXXX - REFERS TO CHAIR MODEL NUMBER)

MODEL	DESCRIPTION	LIST
XXXX-NS02B	Non-Skid Glides	20
GC04 (ordered separately)	Ganging Brackets	75

NOTES:

- Available in two heights: 16" and 24".
- Available in Beech, Walnut and White Oak veneer as well as laminate and Corian.
- Corian top is affixed to table surface increasing overall table height by 1/2" and features a 1/8" reveal.
- **Table with laminate or Corian top, finish selection for table body must be specified.**
- Wood platform base available in Beech, Walnut and White Oak and will match table body unless specified otherwise.
- Rotating tablet and stationary table-ette post is positioned 5 1/2" from front of table.
- Two tone finishing (table and platform base) available at no upcharge as long as within the same wood species.

SPECIFY:

1. Model number
2. Wood species
3. Wood finish
4. Tablet/Table-ette finish, as applicable
5. Tablet/Table-ette post finish, as applicable
6. Options, as applicable

ORDERING EXAMPLE:

#538-122216-CO
12" Wide Table
Corian Top

**OVATE®
MODULAR**

designed by christopher panichella

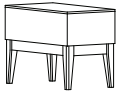
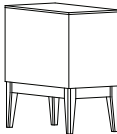
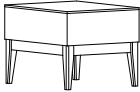
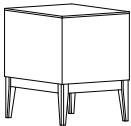

SIN #711-16

MODEL NUMBER	PRODUCT SPECIFICATIONS	TABLE TOP FINISH	
		VENEER OR LAMINATE	CORIAN (-CO)
538-122216 	12" Wide Table W 12 D 22 H 16 25 lbs.	1076	1520
538-122224 	12" Wide High Table (tablet and table-ette option not available) W 12 D 22 H 24 32 lbs.	1151	1596
538-182216 	18" Wide Table W 18 D 22 H 16 30 lbs.	1113	1751
538-182224 	18" Straight High Table (tablet and table-ette option not available) W 18 D 22 H 24 40 lbs.	1206	1842

OPTIONS (XXXX - REFERS TO TABLE MODEL NUMBER)

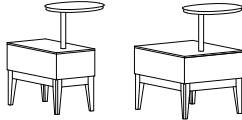
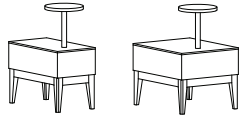
MODEL	DESCRIPTION	LIST	
XXXX-TAC02	Veneer/Laminate Rotating Tablet	326	 Tablet, Center
XXXX-STC01	Veneer/Laminate Stationary Table-ette	304	
XXXX-TAC02-CO	Corian Rotating Tablet	629	 Table-ette, Center
XXXX-STC01-CO	Corian Stationary Table-ette	472	
XXXX-PB1-S	Power Band 1 (one power, two USB), Silver	413	
XXXX-PB1-W	Power Band 1 (one power, two USB), White	413	
XXXX-PB2-S	Power Band 2 (dual power), Silver	322	
XXXX-PB2-W	Power Band 2 (dual power), White	322	
XXXX-PB3-S	Power Band 3 (dual power, two USB), Silver	429	
XXXX-PB3-W	Power Band 3 (dual power, two USB), White	429	
XXXX-NS02B	Non-Skid Glides	20	
GC04 (ordered separately)	Ganging Brackets	75	

OVATE[®] MODULAR

designed by christopher panichella



SIN #711-16

NOTES:

- Available in Beech, Walnut and White Oak veneer as well as laminate and Corian.
- Corian top is affixed to table surface increasing overall table height by 1/2" and features a 1/8" reveal.
- **Table with laminate or Corian top, finish selection for table body must be specified.**
- Wood platform base available in Beech, Walnut and White Oak and will match table body unless specified otherwise.
- Rotating tablet and stationary table-ette post is positioned 5 1/2" from front of table.
- Two tone finishing (table and platform base) available at no upcharge as long as within the same wood species.

SPECIFY:

1. Model number
2. Wood species
3. Wood finish
4. Tablet/Table-ette finish, as applicable
5. Tablet/Table-ette post finish, as applicable
6. Options, as applicable

ORDERING EXAMPLE:

#5390-CO-TAC02-CO-PB1-S

Quarter-Round Corian Table with Corian Tablet, Center Power Band 1 Unit, Silver

MODEL NUMBER	PRODUCT SPECIFICATIONS	TABLE TOP FINISH	
		VENEER OR LAMINATE	CORIAN (-CO)
5390	Quarter-Round Table W 30 ¹ / ₂ D 30 ¹ / ₂ H 16	1522	2806

OPTIONS (XXXX - REFERS TO TABLE MODEL NUMBER)

MODEL	DESCRIPTION	LIST		
Rotating Tablet				
XXXX-TAC02	Veneer/Laminate, Inside Wedge, Center	326		
XXXX-TAR17	Veneer/Laminate, Outside Wedge, Right (as seated)	326		
XXXX-TAL17	Veneer/Laminate, Outside Wedge, Left (as seated)	326		
XXXX-TAR17-TAL17	Veneer/Laminate, Outside Wedge, Right and Left	652	Tablet Center, Inside Wedge	Table-ette Center, Inside Wedge
Stationary Table-ette				
XXXX-TAC02-CO	Corian, Inside Wedge, Center	629		
XXXX-TAR17-CO	Corian, Inside Wedge, Right (as seated)	629		
XXXX-TAL17-CO	Corian, Outside Wedge, Left (as seated)	629		
XXXX-TAR17-CO-TAL17-CO	Corian, Outside Wedge, Right and Left	1258	Tablet Right, Outside Wedge	Table-ette Right, Outside Wedge
XXXX-STC01	Veneer/Laminate, Inside Wedge, Center	304		
XXXX-STR02	Veneer/Laminate, Outside Wedge, Right (as seated)	304		
XXXX-STL02	Veneer/Laminate, Outside Wedge, Left (as seated)	304		
XXXX-STR02-STL02	Veneer/Laminate, Outside Wedge, Right and Left	608	Tablet Left, Outside Wedge	Table-ette Left, Outside Wedge
XXXX-STC01-CO	Corian, Inside Wedge, Center	472		
XXXX-STR02-CO	Corian, Outside Wedge, Right (as seated)	472		
XXXX-STL02-CO	Corian, Outside Wedge, Left (as seated)	472		
XXXX-STR02-CO-STL02-CO	Corian, Outside Wedge, Right and Left	944	Tablet Right & Left, Outside Wedge	Table-ette Right & Left, Outside Wedge
XXXX-PB1-S	Power Band 1 (one power, two USB), Silver	413		
XXXX-PB1-W	Power Band 1 (one power, two USB), White	413		
XXXX-PB2-S	Power Band 2 (dual power), Silver	322		
XXXX-PB2-W	Power Band 2 (dual power), White	322		
XXXX-PB3-S	Power Band 3 (dual power, two USB), Silver	429		
XXXX-PB3-W	Power Band 3 (dual power, two USB), White	429		
XXXX-NS02B	Non-Skid Glides	20		
GC04 (ordered separately)	Ganging Brackets	75		

NOTES:

- All models feature upholstered trim detail.
- Wood platform base available in Beech, Walnut and White Oak.
- Available individually or in modular combinations with armless lounge models, tables and other bench units.
- Refer to page 11 for two-tone upholstery examples and yardage requirements.

SPECIFY:

1. Model number
2. Wood base species
3. Wood base finish
4. Upholstery selection
5. Options, as applicable

ORDERING EXAMPLE:

#5391-NS02B

Quarter-Round Bench
Non-Skid Glides

OVATE®
MODULAR

designed by christopher panichella

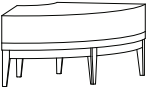

SIN #711-16

MODEL NUMBER	PRODUCT SPECIFICATIONS	FABRIC GRADES								LEATHER GRADES			
		COM	1	2	COL 3	4	5	6	7	8	L1	L2	L3
5361 	22" Bench W 22 ¹ / ₄ D 22 ¹ / ₄ H 18 1 ¹ / ₄ Yds. 28 lbs. COL 25 Sq. Ft. TB 133, add \$60 List	1099	1170	1187	1218	1248	1277	1307	1334	1365	1502	1603	1702
5391 	Quarter-Round Bench W 31 D 31 H 18 1 ¹ / ₂ Yds. 47 lbs. COL 30 Sq. Ft. TB 133, add \$72 List	1333	1419	1439	1475	1511	1546	1582	1615	1652	1817	1938	2056

OPTIONS (XXXX - REFERS TO BENCH MODEL NUMBER)

MODEL	DESCRIPTION	LIST
XXXX-NS02B	Non-Skid Glides	20
GC04 (ordered separately)	Ganging Brackets	75

OVATE[®] MODULAR

designed by christopher panichella



SIN #711-16

NOTES:

- Fixed seat with low backrest and upholstered frame.
- Wood platform base available in Beech, Walnut and White Oak.
- **Available individually or in modular combinations with armless lounge models, tables and other bench units.**
- Refer to page 12 for two-tone upholstery examples and yardage requirements.

SPECIFY:

1. Model number
2. Wood base species
3. Wood base finish
4. Upholstery selection
5. Options, as applicable

ORDERING EXAMPLE:

#5322-NS02B
Two-Seat Bench
Non-Skid Glides

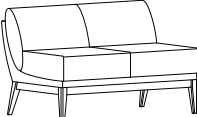
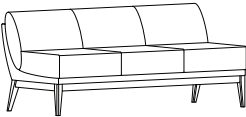
MODEL NUMBER	PRODUCT SPECIFICATIONS	FABRIC GRADES							LEATHER GRADES				
		COM	1	2	COL			6	7	8	L1	L2	L3
5321 	Single Seat Bench, Low Backrest W 22 ¹ / ₂ D 30 ¹ / ₄ H 29 ¹ / ₂ Seat Height 18 2 ¹ / ₂ Yds. 43 lbs. COL 50 Sq. Ft. TB 133, add \$120 List	1370	1512	1546	1607	1667	1725	1785	1840	1901	2176	2378	2575
		1817	2030	2081	2172	2262	2349	2440	2522	2613	3026	3329	3625
5322 	Two-Seat Bench, Low Backrest W 44 ¹ / ₂ D 30 ¹ / ₄ H 29 ¹ / ₂ Seat Height 18 3 ³ / ₄ Yds. 66 lbs. COL 75 Sq. Ft. TB 133, add \$180 List	2354	2638	2706	2827	2948	3063	3184	3294	3415	3966	4370	4764
5323 	Three-Seat Bench, Low Backrest W 66 ¹ / ₂ D 30 ¹ / ₄ H 29 ¹ / ₂ Seat Height 18 5 Yds. 94 lbs. COL 100 Sq. Ft. TB 133, add \$240 List												

OPTIONS (XXXX - REFERS TO BENCH MODEL NUMBER)

MODEL	DESCRIPTION	LIST
XXXX-NS02B	Non-Skid Glides	20
GC04 (ordered separately)	Ganging Brackets	75

NOTES:

- Fixed seat with upholstered trim detail.
- Center table and wood platform base available in Beech, Walnut and White Oak.
- **Available individually or in modular combinations with armless lounge models, tables and other bench units.**
- Refer to page 4 for two-tone upholstery examples and yardage requirements.
- Tablet and table-ette mounting post will be positioned in the center of table as standard, unless otherwise specified.
- Refer to page 12 for two-tone upholstery examples and yardage requirements.

SPECIFY:

1. Model number
2. Wood species
3. Wood finish
4. Tablet/Table-ette finish, as applicable
5. Tablet/Table-ette post finish, as applicable
6. Options, as applicable

ORDERING EXAMPLE:

#5332-T-PB3-W

Two-Seat Bench, Center Table
Power Band 3 Unit, White

**OVATE®
MODULAR**

designed by christopher panichella

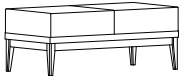
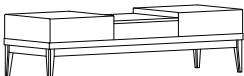
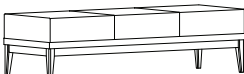

SIN #711-16

MODEL NUMBER	PRODUCT SPECIFICATIONS	FABRIC GRADES							LEATHER GRADES				
		COM	1	2	COL 3	4	5	6	7	8	L1	L2	L3
5332 	Two-Seat Bench W 44 ¹ / ₄ D 22 ¹ / ₄ H 18 2 ¹ / ₄ Yds. 60 lbs. COL 45 Sq. Ft. TB 133, add \$108 List	1468	1596	1627	1681	1735	1787	1842	1891	1946	2194	2376	2553
5332-T 	Two Seat Bench with Center Table W 68 D 22 ¹ / ₄ H 18 2 ¹ / ₄ Yds. 88 lbs. COL 45 Sq. Ft. TB 133, add \$108 List	1877	2005	2036	2090	2144	2196	2251	2300	2355	2603	2785	2962
5333 	Three-Seat Bench W 68 D 22 ¹ / ₄ H 18 3 ¹ / ₄ Yds. 88 lbs. COL 65 Sq. Ft. TB 133, add \$156 List	1865	2050	2094	2173	2251	2326	2405	2476	2555	2913	3176	3432

OPTIONS (XXXX - REFERS TO BENCH MODEL NUMBER). TABLETS, TABLE-ETTES AND POWER UNITS AVAILABLE ON MODEL #5332-T ONLY.

MODEL	DESCRIPTION	LIST
XXXX-TAC02	Veneer/Laminate Rotating Tablet	326
XXXX-STC01	Veneer/Laminate Stationary Table-ette	304
XXXX-TAC02-CO	Corian Rotating Tablet	629
XXXX-STC01-CO	Corian Stationary Table-ette	472
XXXX-PB1-S	Power Band 1 (one power, two USB), Silver	413
XXXX-PB1-W	Power Band 1 (one power, two USB), White	413
XXXX-PB2-S	Power Band 2 (dual power), Silver	322
XXXX-PB2-W	Power Band 2 (dual power), White	322
XXXX-PB3-S	Power Band 3 (dual power, two USB), Silver	429
XXXX-PB3-W	Power Band 3 (dual power, two USB), White	429
XXXX-NS02B	Non-Skid Glides	20
GC04 (ordered separately)	Ganging Brackets	75

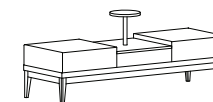
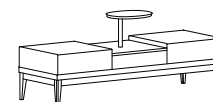

OVATE[®] MODULAR

designed by christopher panichella



SIN #711-16

CONFIGURATION AND ORDERING EXAMPLES

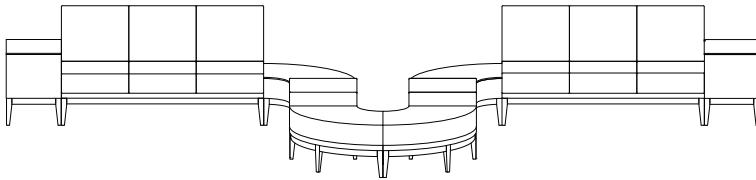

OVERALL DIMENSIONS
LENGTH 246"
DEPTH 113"

Qty	Model #	Description	COM List
2	538-182224	18" High Table (\$1,206 each)	2,412
2	5313	Armless Sofa (\$2,681 each)	5,362
2	5390	Quarter-Round Table (\$1,522 each)	3,044
2	5332	Two-Seat Bench (\$1,468 each)	2,936
2	5391	Quarter-Round Bench (\$1,333 each)	2,666
10			16,420

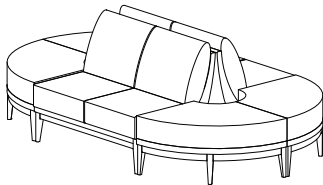

OVERALL DIMENSIONS
LENGTH 105"
DEPTH 62"

Qty	Model #	Description	COM List
2	5312	Armless Love Seat (\$1,988 each)	3,976
4	5391	Quarter-Round Bench (\$1,333 each)	5,332
6			9,308

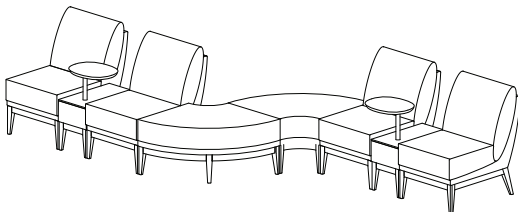

OVERALL DIMENSIONS
LENGTH 150.5"
DEPTH 69"

Qty	Model #	Description	COM List
4	5311	Armless Lounge Chair (\$1,385 each)	5,540
2	538-122216-TAC02	12" Table with Rotating Tablet (\$1,402 each)	2,804
2	5391	Quarter-Round Bench (\$1,333 each)	2,666
8			11,010

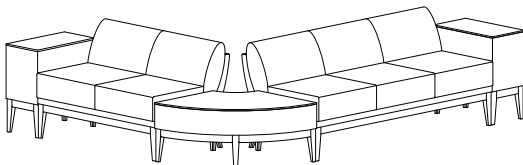

OVERALL DIMENSIONS
LENGTH 108"
DEPTH 86"

Qty	Model #	Description	COM List
2	538-122224	12" Wide High Table (\$1,151 each)	2,302
1	5312	Armless Love Seat	1,988
1	5390	Quarter-Round Table	1,522
1	5313	Armless Sofa	2,681
5			8,493

UPHOLSTERY COMBINATIONS:

For fabric, vinyl or leather upholstery combinations, refer to the pricing below:

- When combining **two** COM/COV/COL fabrics, or fabrics with the same grade, add the following (per unit):
 - › \$65 List for lounge chairs and benches
 - › \$105 List for love seats
 - › \$130 List for sofas
- When combining **three or more** COM/COV/COL fabrics, or fabrics with the same grade, add the following (per unit):
 - › \$75 List for lounge chairs and benches
 - › \$115 List for love seats
 - › \$140 List for sofas

- When combining different grades of fabric, price will be based on the highest grade specified.
- Two-tone upholstery examples and yardage requirements for the most common combinations are listed below. Additional combinations available, please contact Customer Service for yardage requirements and pricing.
- Note: Yardage amounts are based on fabric which is plain (i.e. non-directional) and a full 54" wide.
- **Appropriate upholstery code must be included on order.**

OVATE®
MODULAR

designed by christopher panichella



SIN #711-16

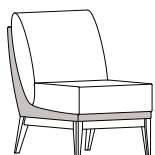

Code OV13

Model COM Requirement
5311 Upholstered Frame = 1¹/₄ yds.
Balance of Chair = 1³/₄ yds.

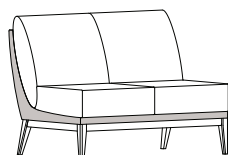

Code OV14

Model COM Requirement
5312 Upholstered Frame = 1¹/₂ yds.
Balance of Chair = 3 yds.

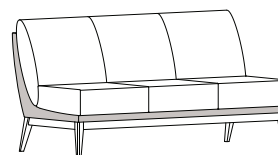

Code OV15

Model COM Requirement
5313 Upholstered Frame = 2 yds.
Balance of Chair = 4 yds.

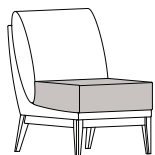

Code OV16

Model COM Requirement
5311 Seat Cushion Only = 1 yd.
Balance of Chair = 2¹/₄ yds.

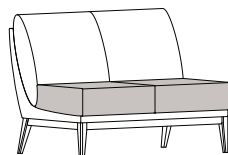

Code OV17

Model COM Requirement
5312 Seat Cushion Only = 1¹/₂ yds.
Balance of Chair = 3 yds.

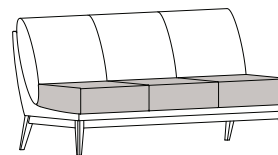

Code OV18

Model COM Requirement
5313 Seat Cushion Only = 2 yds.
Balance of Chair = 4 yds.

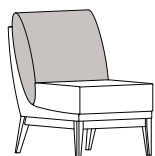

Code OV19

Model COM Requirement
5311 Back Cushion Only = 1¹/₄ yds.
Balance of Chair = 2 yds.

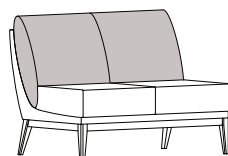

Code OV20

Model COM Requirement
5312 Back Cushion Only = 2 yds.
Balance of Chair = 3 yds.

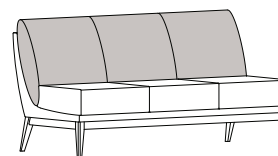

Code OV21

Model COM Requirement
5313 Back Cushion Only = 2¹/₂ yds.
Balance of Chair = 4 yds.



Code OV22

Model COM Requirement
5361 Upholstered Trim = 1/2 yd.
Balance of Bench = 1 yd.

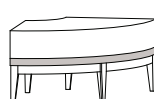

Code OV23

Model COM Requirement
5391 Upholstered Trim = 1/2 yd.
Balance of Bench = 1¹/₄ yds.

OVATE[®] MODULAR

designed by christopher panichella



UPHOLSTERY COMBINATIONS:

For fabric, vinyl or leather upholstery combinations, refer to the pricing below:

- When combining **two** COM/COV/COL fabrics, or fabrics with the same grade, add the following (per unit):
 - › \$65 List for lounge chairs and benches
 - › \$105 List for love seats
 - › \$130 List for sofas
- When combining **three or more** COM/COV/COL fabrics, or fabrics with the same grade, add the following (per unit):
 - › \$75 List for lounge chairs and benches
 - › \$115 List for love seats
 - › \$140 List for sofas

- When combining different grades of fabric, price will be based on the highest grade specified.
- Two-tone upholstery examples and yardage requirements for the most common combinations are listed below. Additional combinations available, please contact Customer Service for yardage requirements and pricing.
- Note: Yardage amounts are based on fabric which is plain (i.e. non-directional) and a full 54" wide.
- **Appropriate upholstery code must be included on order.**

SIN #711-16

CONFIGURATION AND ORDERING EXAMPLES



Code OV24
Model COM Requirement
 5321 Upholstered Frame = 1 yd.
 Balance of Bench = 1³/₄ yds.

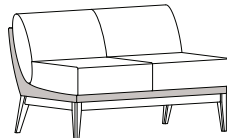

Code OV25
Model COM Requirement
 5322 Upholstered Frame = 1¹/₄ yds.
 Balance of Bench = 2³/₄ yds.

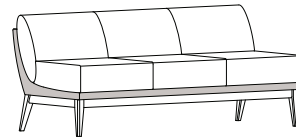

Code OV26
Model COM Requirement
 5323 Upholstered Frame = 1³/₄ yds.
 Balance of Bench = 3¹/₂ yds.



Code OV27
Model COM Requirement
 5321 Seat Cushion Only = 1 yd.
 Balance of Bench = 1³/₄ yds.

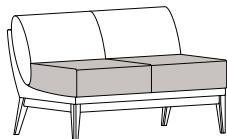

Code OV28
Model COM Requirement
 5322 Seat Cushion Only = 1¹/₂ yds.
 Balance of Bench = 2¹/₂ yds.

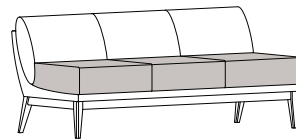

Code OV29
Model COM Requirement
 5323 Seat Cushion Only = 2¹/₄ yds.
 Balance of Bench = 3¹/₄ yds.



Code OV30
Model COM Requirement
 5321 Back Cushion Only = 1 yd.
 Balance of Bench = 1³/₄ yds.

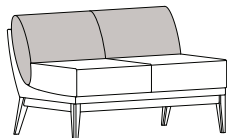

Code OV31
Model COM Requirement
 5322 Back Cushion Only = 1¹/₂ yds.
 Balance of Bench = 2¹/₂ yds.

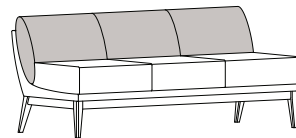

Code OV32
Model COM Requirement
 5323 Back Cushion Only = 2 yds.
 Balance of Bench = 3¹/₂ yds.

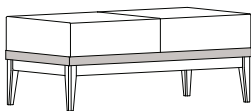

Code OV33
Model COM Requirement
 5332 Upholstered Trim = 1¹/₂ yd.
 Balance of Bench = 1³/₄ yds.

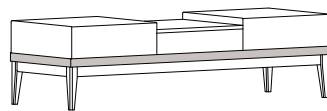

Code OV34
Model COM Requirement
 5332-T Upholstered Trim = 3³/₄ yd.
 Balance of Bench = 1³/₄ yds.

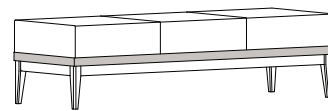

Code OV35
Model COM Requirement
 5333 Upholstered Trim = 3³/₄ yd.
 Balance of Bench = 2³/₄ yds.



OVATE® OCCASIONAL TABLES

designed by christopher panichella

SIN #711-11

PRODUCT FEATURES:

- Tables manufactured in Beech, Walnut and White Oak.
- Custom sizes available, contact Customer Service for pricing.
- All standard and custom wood finishes available.
- For custom wood finishes, please add one-time upcharge of \$400 List per color per order.
- Laminate and Corian tops available (veneer body as standard, finish must be specified).
- For standard laminates, refer to Standard Finish Card.
- For custom laminates, add \$500 List per color per order. Pre-approval required, please contact Customer Service.
- Corian top is affixed to table surface increasing overall table height by 1/2". Please note that a 1/8" reveal will be present.
- Corian top available in four standard colors. For non-standard colors, please contact Customer Service for pricing.
- **Table with laminate or Corian top, finish selection for table body must be specified.**
- Two-tone finishing (table and platform base) available at no upcharge as long as within the same wood species.
- Non-skid glides available for hard surface floors. Please specify "-NS02B" after model number and add \$20 List per unit.
- All dimensions are nominal.

CORIAN® COLORS:

Designer White
Linen
Rain Cloud
Witch Hazel

Corian® is a registered trademark of Dupont.

OVATE®
OCCASIONAL TABLES
 designed by christopher panichella



NOTES:

- Tables manufactured in Beech, Walnut and White Oak.
- Laminate and Corian tops available (veneer body as standard, finish must be specified).
- For Corian tops, specify “-CO” next to model number and select color.
- Two-tone finishing (table and platform base) available at no upcharge as long as within the same wood species.

SPECIFY:

1. Model number
2. Wood species
3. Wood finish
4. Base finish
5. Options, as applicable

ORDERING EXAMPLE:

#536-3016-CO-NS02B

 30" Round Table
 Corian Top
 Non-Skid Glides

SIN #711-11

MODEL NUMBER PRODUCT SPECIFICATIONS

			MODEL NUMBER	VENEER OR LAMINATE	CORIAN (-CO)	WEIGHT
536 	Ovate Round Table 536 Series		536-2216	1249	1887	25
			536-2220	1308	1947	32
			536-3016	1734	2729	47
			536-3616	2141	3788	58
			536-442216	1747	2806	49
537 	Ovate Square Table 537 Series		537-222216	1189	1809	37
			537-222220	1235	1855	39
			537-303016	1578	2544	55
			537-363616	1810	3406	64
			537-482016	1737	2768	60

OPTIONS (XXXX - REFERS TO TABLE MODEL NUMBER)

MODEL	DESCRIPTION	LIST
XXXX-NS02B	Non-Skid Glides	20

= Available on Quick-Ship Program, models #536-2220, #536-3016, #537-222220 and #537-303016 (Beech and Walnut wood species and finishes only).

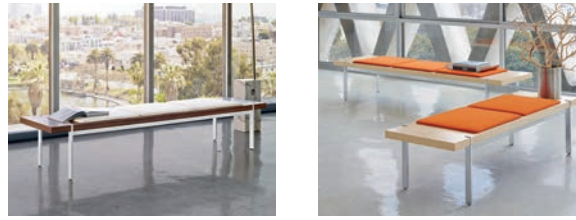

RADIANT BENCHES

designed by christopher panichella

SIN #711-16

PRODUCT FEATURES:

- Three wood species available: Maple, Walnut and White Oak.
- All standard and custom wood finishes available.
- For custom wood finishes, please add one-time upcharge of \$400 List per color per order.
- Wood grain direction runs lengthwise as standard.
- Edge will match top finish color as standard, unless specified otherwise.
- Laminate top features laminate self edge.
- For standard laminates, refer to Standard Finish Card.
- For custom laminates, add \$500 List per color per order. Pre-approval required, please contact Customer Service.
- Metal frame integrated into wood frame for design detail.
- Inset seat cushions feature suspension support for optimum comfort.
- Metal frame available in standard and premium color selections.
- For premium metal finishes, please specify “-PF04” with color selection and add \$135 List per unit.
- Maximum weight capacity is 350 lbs. for two-seat benches and 700 lbs. for three-seat benches.
- Non-skid glides available for hard surface floors. Please specify “-NS02B” after model number and add \$20 List per unit.

STANDARD FRAME FINISHES:

#06 Charcoal Grey
#90 Metallic Silver
#92 Polished Aluminum
#95 Satin Black

PREMIUM FRAME FINISHES:

#07 Gold Shimmer
#08 Penny
#09 Brown Sugar
#83 Metallic Champagne
#94 Cotton

RADIANT BENCHES

designed by christopher panichella



NOTES:

- Three wood species available: Maple, Walnut and White Oak.
- Metal frame integrated into wood frame for design detail.
- Inset seat cushions feature suspension support for optimum comfort.
- Metal frame available in standard and premium color selections.

SPECIFY:

1. Model number
2. Wood species
3. Wood finish
4. Frame finish
5. Upholstery selection
6. Options, as applicable

ORDERING EXAMPLE:

#7102-NS02B
Two-Seat Bench
Non-Skid Glides

SIN #711-16

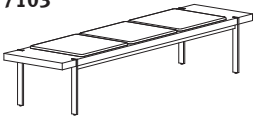
MODEL NUMBER	PRODUCT SPECIFICATIONS	FABRIC GRADES								LEATHER GRADES			
		COM	1	2	COL			6	7	8	L1	L2	L3
7102 	Two-Seat Bench W 66 D 22 H 17 ¹ / ₂ 3/4 Yd. 70 lbs. COL 15 Sq. Ft. TB 133, add \$36 List	1914	1957	1967	1985	2003	2021	2039	2055	2074	2156	2217	2276
		2533	2619	2639	2675	2711	2746	2782	2815	2852	3017	3138	3256
7103 	Three-Seat Bench W 89 D 22 H 17 ¹ / ₂ 1 ¹ / ₂ Yds. 95 lbs. COL 30 Sq. Ft. TB 133, add \$72 List	2533	2619	2639	2675	2711	2746	2782	2815	2852	3017	3138	3256
		2533	2619	2639	2675	2711	2746	2782	2815	2852	3017	3138	3256

OPTIONS (XXXX - REFERS TO BENCH MODEL NUMBER)

MODEL	DESCRIPTION	LIST
XXXX-PF04	Premium Finish	135
XXXX-NS02B	Non-Skid Glides	20



RADIANT OCCASIONAL TABLES

designed by christopher panichella

SIN #711-11

PRODUCT FEATURES:

- Two table heights: 17" and 19".
- Tables manufactured in Maple, Walnut or White Oak.
- All standard and custom wood finishes available.
- For custom wood finishes, please add one-time upcharge of \$400 List per color per order.
- Laminate top features laminate self edge.
- For standard laminates, refer to Standard Finish Card.
- For custom laminates, add \$500 List per color per order. Pre-approval required, please contact Customer Service.
- Custom 18" high table available. Please specify and add \$200 List to the 17" high table price, per unit.
- Metal frame available in standard and premium color selections.
- For premium metal finishes, please specify "-PF04" with color selection and add \$135 List per table.
- Non-skid glides available for hard surface floors. Please specify "-NS02B" after model number and add \$20 List per unit.

STANDARD FRAME FINISHES:

#06 Charcoal Grey
#90 Metallic Silver
#92 Polished Aluminum
#95 Satin Black

PREMIUM FRAME FINISHES:

#07 Gold Shimmer
#08 Penny
#09 Brown Sugar
#83 Metallic Champagne
#94 Cotton

RADIANT OCCASIONAL TABLES

designed by christopher panichella



NOTES:

- Two table heights: 17" and 19".
- Tables manufactured in Maple, Walnut or White Oak as well as laminate selections.
- Custom 18" high table available. Please specify and add \$200 List to the 17" high table price, per unit.
- Metal frame available in standard and premium color selections.

SPECIFY:

1. Model number
2. Wood species
3. Wood finish
4. Frame finish
5. Options, as applicable

ORDERING EXAMPLE:

#710-181817-NS02B

18" Square Table
Non-Skid Glides

SIN #711-11

MODEL NUMBER PRODUCT SPECIFICATIONS

		MODEL NUMBER	LIST	WEIGHT	
<p>710</p> <p>Radiant Table, 17" Height 710 Series</p> <p>Standard Frame Finishes</p>					
		710-181817	1097	16	
		710-222217	1271	24	
		710-303017	1533	44	
		710-363617	1756	53	
		710-424217	2086	86	
		710-484817	2369	112	
		710-482017	1574	46	
	<p>710</p> <p>Radiant Table, 19" Height 710 Series</p> <p>Standard Frame Finishes</p>				
			710-181819	1172	17
		710-222219	1347	25	
		710-303019	1608	45	

OPTIONS (XXXX - REFERS TO TABLE MODEL NUMBER)

MODEL	DESCRIPTION	LIST
XXXX-PF04	Premium Finish	135
XXXX-NS02B	Non-Skid Glides	20



REPRISE GUEST-TANDEM

designed by david dahl

SIN #711-17

PRODUCT FEATURES:

- Four arm cap options: wood, black urethane, grey urethane and Corian.
- Wood arm caps available in all standard and custom wood finishes on Beech.
- For custom wood finishes, please add one-time upcharge of \$400 List per color per order.
- Corian arm caps available in four standard colors. For non-standard colors, please contact Customer Service for pricing.
- Bariatric settee available in two sizes.
- Non-skid glides available for hard surface floors. Refer to individual pages for specification information and pricing.
- Please refer to page 20 for two-tone upholstery examples, yardage requirements and pricing.
- All dimensions are nominal.

CORIAN® COLORS:

Designer White
Linen
Rain Cloud
Witch Hazel

Corian® is a registered trademark of Dupont.

WEIGHT CAPACITY:

- | | |
|--------------------------|-------------------|
| ▪ Guest Chair | 350 lbs. |
| ▪ Preconfigured Tandem | 350 lbs. per seat |
| ▪ Reconfigurable Tandem | 350 lbs. per seat |
| ▪ Bariatric Chairs | 750 lbs. |
| ▪ Easy Access/Hip Chairs | 350 lbs. |
| ▪ Patient Chairs | 350 lbs. |

REPRISE GUEST-TANDEM

designed by david dahl



SIN #711-17

SPECIAL FEATURES:

- Arm cap features radiused edges for smooth surface contact.
- All styles field-replaceable.
- Clean-outs on every side, including between the seat and back, featured on all models including bariatric sizes, patient chair and hip chair.
- Enables crumbs and debris to fall through for maintenance ease.
- Radiused edges.
- Wall-saver leg design.
- Optional replaceable seat upholstery available on all seating models including bariatric sizes as well as the hip and patient chair.
- Replacement seat and back covers can be easily field installed on previously ordered Reprise models with standard fixed upholstery. Contact Customer Service for instructions.
- For the complete list of replaceable components, please refer to pages 17-19.

TANDEM MODULAR UNITS PRODUCT FEATURES:

- To build tandem configurations, always specify units from left-to-right, as facing.
- Available in two and three-seat combinations or as reconfigurable modular units.
- Bariatric settee available in two sizes.
- Two sizes of in-line tables available: 15" and 21", in Beech veneer, laminate or with a Corian top.
- Veneer and laminate tables are $\frac{3}{4}$ " thick with hardwood edge.
- Corian top is affixed to table surface increasing overall table height by $\frac{1}{2}$ ".
- **Table with Corian top, wood edge finish selection must be specified.**
- All standard and custom wood finishes available.
- For custom wood finishes, please add \$400 List per color per order.
- When ordering in laminate, specify laminate manufacturer, color and pattern number.
- For standard laminates, refer to Standard Finish Card.
- For custom laminates, add \$500 List per color per order. Pre-approval required, please contact Customer Service.
- **Note: Please include seating/table layout drawings or sketch with each order.**
- Arcadia will pre-assemble units at the factory to maximize shipping allowances and minimize field assembly.

NOTES:

- Wood arm caps available in Beech.
- For Corian arm caps, please specify “-CO” in place of the “-W” after model number (with color selection) and refer to options below for upcharge.
- Refer to page 20 for two-tone upholstery examples and yardage requirements.

SPECIFY:

1. Model number
2. Arm cap finish
3. Frame finish
4. Upholstery selection
5. Options, as applicable

ORDERING EXAMPLE:

#3410-W-SC01-MB01

Guest Chair
Wood Arms
Replaceable Seat Cover
Moisture Barrier

**REPRISE
GUEST-TANDEM**

designed by david dahl

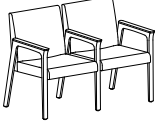
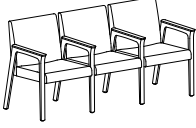

SIN #711-17

MODEL NUMBER	PRODUCT SPECIFICATIONS	FABRIC GRADES							LEATHER GRADES				
		COM	1	2	COL 3	4	5	6	7	8	L1	L2	L3
3410-W	 <p>Single Guest Chair Wood Arm Caps W 24¹/₂ D 25¹/₂ H 33¹/₂ Seat Height 18 Inside Seat Width 20 Inside Seat Depth 19 Arm Height 25¹/₂ 1¹/₂ Yds. 34 lbs. COL 30 Sq. Ft. TB 133, add \$72 List</p>	996	1082	1102	1138	1174	1209	1245	1278	1315	1480	1601	1719
3410-2-W	 <p>Two-Seat Tandem Wood Arm Caps W 47 D 25¹/₂ H 33¹/₂ Seat Height 18 Inside Seat Width 20 Inside Seat Depth 19 Arm Height 25¹/₂ 3 Yds. 62 lbs. COL 60 Sq. Ft. TB 133, add \$144 List</p>	1839	2010	2051	2123	2195	2265	2337	2403	2476	2807	3049	3285
3410-3-W	 <p>Three-Seat Tandem Wood Arm Caps W 70 D 25¹/₂ H 33¹/₂ Seat Height 18 Inside Seat Width 20 Inside Seat Depth 19 Arm Height 25¹/₂ 4¹/₂ Yds. 91 lbs. COL 90 Sq. Ft. TB 133, add \$216 List</p>	2682	2938	2999	3108	3216	3320	3429	3528	3637	4133	4497	4851

OPTIONS (XXXX - REFERS TO CHAIR MODEL NUMBER)

MODEL	DESCRIPTION	LIST
XXXX-CO	Corian Arm Cap (per arm)	130
XXXX-MB01	Moisture Barrier (seat only, per seat)	50
XXXX-SC01	Replaceable Seat Cover (per seat)	45
XXXX-BC01	Replaceable Back Cover (per back)	30
XXXX-NS02A	Non-Skid Glides (per arm frame)	10

REPRISE GUEST-TANDEM

designed by david dahl

NOTES:

- Urethane arm caps available in Grey or Black.
- Refer to page 20 for two-tone upholstery examples and yardage requirements.

SPECIFY:



1. Model number
2. Frame finish
3. Upholstery selection
4. Options, as applicable

ORDERING EXAMPLE:

#3410-UG-NS02A

34" Wide Bariatric Settee
Grey Urethane Arm Caps
Non-Skid Glides

SIN #711-17

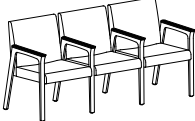
MODEL NUMBER	PRODUCT SPECIFICATIONS	FABRIC GRADES							LEATHER GRADES				
		COM	1	2	COL 3	4	5	6	7	8	L1	L2	L3
3410-UB (BLACK) 3410-UG (GREY) 	Single Guest Chair Urethane Arm Caps W 24 ¹ / ₂ D 25 ¹ / ₂ H 33 ¹ / ₂ Seat Height 18 Inside Seat Width 20 Inside Seat Depth 19 Arm Height 25 ¹ / ₂ 1 ¹ / ₂ Yds. 34 lbs. COL 30 Sq. Ft. TB 133, add \$72 List	1036	1122	1142	1178	1214	1249	1285	1318	1355	1520	1641	1759
3410-2-UB (BLACK) 3410-2-UG (GREY) 	Two-Seat Tandem Urethane Arm Caps W 47 D 25 ¹ / ₂ H 33 ¹ / ₂ Seat Height 18 Inside Seat Width 20 Inside Seat Depth 19 Arm Height 25 ¹ / ₂ 3 Yds. 62 lbs. COL 60 Sq. Ft. TB 133, add \$144 List	1899	2070	2111	2183	2255	2325	2397	2463	2536	2867	3109	3345
3410-3-UB (BLACK) 3410-3-UG (GREY) 	Three-Seat Tandem Urethane Arm Caps W 70 D 25 ¹ / ₂ H 33 ¹ / ₂ Seat Height 18 Inside Seat Width 20 Inside Seat Depth 19 Arm Height 25 ¹ / ₂ 4 ¹ / ₂ Yds. 91 lbs. COL 90 Sq. Ft. TB 133, add \$216 List	2762	3018	3079	3188	3296	3400	3509	3608	3717	4213	4577	4931

OPTIONS (XXXX - REFERS TO CHAIR MODEL NUMBER)

MODEL	DESCRIPTION	LIST
XXXX-MB01	Moisture Barrier (seat only, per seat)	50
XXXX-SC01	Replaceable Seat Cover (per seat)	45
XXXX-BC01	Replaceable Back Cover (per back)	30
XXXX-NS02A	Non-Skid Glides (per arm frame)	10

NOTES:

- Bariatric models feature 750 lbs. maximum seat capacity.
- Wood arm caps available in Beech.
- For Corian arm caps, please specify “-CO” in place of the “-W” after model number (with color selection) and refer to options below for upcharge.
- Refer to page 20 for two-tone upholstery examples and yardage requirements.

SPECIFY:

1. Model number
2. Arm cap finish
3. Frame finish
4. Upholstery selection
5. Options, as applicable

ORDERING EXAMPLE:

#3440-W-NS02B

34” Wide Bariatric Settee
Wood Arm Caps
Non-Skid Glides

REPRISE GUEST-TANDEM

designed by david dahl

SIN #711-17

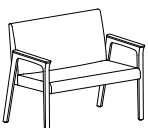
MODEL NUMBER	PRODUCT SPECIFICATIONS	FABRIC GRADES								LEATHER GRADES			
		COM	1	2	COL 3	4	5	6	7	8	L1	L2	L3
3440-W 	Bariatric Settee, 34" Wide, Wood Arm Caps W 34 D 25 ¹ / ₂ H 33 ¹ / ₂ Seat Height 18 Inside Seat Width 30 Inside Seat Depth 19 Arm Height 25 ¹ / ₂ 2 ¹ / ₂ Yds. 45 lbs. COL 50 Sq. Ft. TB 133, add \$120 List	1324	1466	1500	1561	1621	1679	1739	1794	1855	2130	2332	2529
3445-W 	Bariatric Settee, 40" Wide, Wood Arm Caps W 40 D 25 ¹ / ₂ H 33 ¹ / ₂ Seat Height 18 Inside Seat Width 33 Inside Seat Depth 19 Arm Height 25 ¹ / ₂ 2 ¹ / ₂ Yds. 68 lbs. COL 50 Sq. Ft. TB 133, add \$120 List	1514	1656	1690	1751	1811	1869	1929	1984	2045	2320	2522	2719

OPTIONS (XXXX - REFERS TO CHAIR MODEL NUMBER)

MODEL	DESCRIPTION	LIST
XXXX-CO	Corian Arm Caps	260
XXXX-MB02	Moisture Barrier, Seat Only	95
XXXX-SC02	Replaceable Seat Cover	60
XXXX-BC02	Replaceable Back Cover	45
XXXX-NS02B	Non-Skid Glides	20

REPRISE GUEST-TANDEM

designed by david dahl

NOTES:

- Bariatric models feature 750 lbs. maximum seat capacity.
- Urethane arm caps available in Grey or Black.
- Refer to page 20 for two-tone upholstery examples and yardage requirements.

SPECIFY:

1. Model number
2. Frame finish
3. Upholstery selection
4. Options, as applicable

ORDERING EXAMPLE:

#3440-UB-NS02B

34" Wide Bariatric Settee
Black Urethane Arm Caps
Non-Skid Glides

SIN #711-17

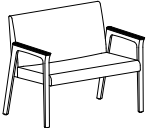
MODEL NUMBER	PRODUCT SPECIFICATIONS	FABRIC GRADES							LEATHER GRADES				
		COM	1	2	COL			8	L1	L2	L3		
3440-UB (BLACK) 3440-UG (GREY) 	Bariatric Settee, 34" Wide, Urethane Arm Caps W 34 D 25 ¹ / ₂ H 33 ¹ / ₂ Seat Height 18 Inside Seat Width 30 Inside Seat Depth 19 Arm Height 25 ¹ / ₂ 2 ¹ / ₂ Yds. 45 lbs. COL 50 Sq. Ft. TB 133, add \$120 List	1364	1506	1540	1601	1661	1719	1779	1834	1895	2170	2372	2569
3445-UB (BLACK) 3445-UG (GREY) 	Bariatric Settee, 40" Wide, Urethane Arm Caps W 40 D 25 ¹ / ₂ H 33 ¹ / ₂ Seat Height 18 Inside Seat Width 33 Inside Seat Depth 19 Arm Height 25 ¹ / ₂ 2 ¹ / ₂ Yds. 68 lbs. COL 50 Sq. Ft. TB 133, add \$120 List	1554	1696	1730	1791	1851	1909	1969	2024	2085	2360	2562	2759

OPTIONS (XXXX - REFERS TO CHAIR MODEL NUMBER)

MODEL	DESCRIPTION	LIST
XXXX-MB02	Moisture Barrier, Seat Only	95
XXXX-SC02	Replaceable Seat Cover	60
XXXX-BC02	Replaceable Back Cover	45
XXXX-NS02B	Non-Skid Glides	20

NOTES:

- Center tables for pre-configured tandem units and configurable modular units.
- Custom sizes available, contact Customer Service for pricing.
- Tables are Beech veneer with hardwood edge.
- For Corian top, specify “-CO” next to model number.
- Beech veneer and laminate tops are 3/4" thick. Corian tops are 1/2" thick.
- Tables are field installed.

SPECIFY:

1. Model number
2. Table top finish
3. Leg finish, as applicable
4. Options, as applicable

Center tables include arm frame for connecting purposes. To add seating units, subsequent chair will always be the 'AO' (add-on) or 'EU' (end unit).

ORDERING EXAMPLE:

#3417-15-CO

15" Wide Center Table
Corian Top

REPRISE GUEST-TANDEM

designed by david dahl

SIN #711-17

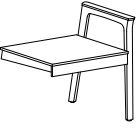
MODEL NUMBER	PRODUCT SPECIFICATIONS	TABLE TOP FINISH	
		VENEER OR LAMINATE	CORIAN (-CO)
 <p>3417-15</p>	<p>15" Center Table In-Line Add-On W 15 D 21 13 lbs. Field Installed</p>	514	834
 <p>3417-21</p>	<p>21" Center Table In-Line Add-On W 21 D 21 14 lbs. Field Installed</p>	581	983

REPRISE GUEST-TANDEM

designed by david dahl

NOTES:

- To build tandem configurations, always specify units from left-to-right as facing.
- Starter units (“-ST”) represent the first seating model in a configuration with subsequent modular units building onto them towards the right.
- Add-On units (“-AO”) can only be added next to Starter units or other Add-On units.
- End-units (“-EU”) represent the final seating model in a configuration.
- Center tables are for in-line placement only (cannot start or end a configuration) and include arm frame for connecting purposes. To add seating units, subsequent chair will always be the 'AO' (add-on) or 'EU' (end unit).
- For Corian arm caps, please specify “-CO” in place of the “-W” after model number (with color selection) and refer to options below for upcharge.

SIN #711-17

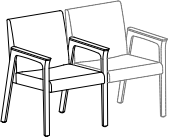
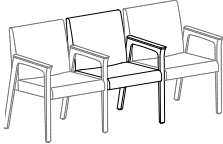
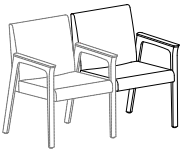
MODEL NUMBER	PRODUCT SPECIFICATIONS	FABRIC GRADES							LEATHER GRADES				
		COL	1	2	3	4	5	6	7	8	L1	L2	L3
3420-ST-W	 <p>Tandem Starter Unit Wood Arm Caps W 24¹/₂ D 25¹/₂ H 33¹/₂ Seat Height 18 Inside Seat Width 20 Inside Seat Depth 19 Arm Height 25¹/₂ 1¹/₂ Yds. 34 lbs. COL 30 Sq. Ft. TB 133, add \$72 List</p>	998	1084	1104	1140	1176	1211	1247	1280	1317	1482	1603	1721
3420-AO-W	 <p>Tandem Add-On Unit Wood Arm Cap W 22¹/₂ D 25¹/₂ H 33¹/₂ Seat Height 18 Inside Seat Width 20 Inside Seat Depth 19 Arm Height 25¹/₂ 1¹/₂ Yds. 31 lbs. COL 30 Sq. Ft. TB 133, add \$72 List</p>	874	960	980	1016	1052	1087	1123	1156	1193	1358	1479	1597
3420-EU-W	 <p>Tandem End Unit Wood Arm Cap W 22¹/₂ D 25¹/₂ H 33¹/₂ Seat Height 18 Inside Seat Width 20 Inside Seat Depth 19 Arm Height 25¹/₂ 1¹/₂ Yds. 31 lbs. COL 30 Sq. Ft. TB 133, add \$72 List</p>	874	960	980	1016	1052	1087	1123	1156	1193	1358	1479	1597

Connecting Tables Page 7
Bariatric Models Pages 10-13

OPTIONS (XXXX - REFERS TO CHAIR MODEL NUMBER)

MODEL	DESCRIPTION	LIST
XXXX-CO	Corian Arm Caps (per arm)	130
XXXX-SC01	Replaceable Seat Cover (per seat)	45
XXXX-BC01	Replaceable Back Cover (per back)	30
XXXX-MB01	Moisture Barrier (seat only, per seat)	50
XXXX-NS02A	Non-Skid Glides (per arm frame)	10



NOTES:

- To build tandem configurations, always specify units from left-to-right as facing.
- Starter units (“-ST”) represent the first seating model in a configuration with subsequent modular units building onto them towards the right.
- Add-On units (“-AO”) can only be added next to Starter units or other Add-On units.
- End-units (“-EU”) represent the final seating model in a configuration.
- Center tables are for in-line placement only (cannot start or end a configuration) and include arm frame for connecting purposes. To add seating units, subsequent chair will always be the 'AO' (add-on) or 'EU' (end unit).
- Urethane arm caps available in Grey or Black.

REPRISE GUEST-TANDEM

designed by david dahl

SIN #711-17

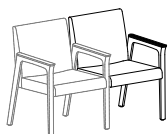
MODEL NUMBER	PRODUCT SPECIFICATIONS	FABRIC GRADES							LEATHER GRADES				
		COM	1	2	COL 3	4	5	6	7	8	L1	L2	L3
3420-ST-UB (BLACK) 3420-ST-UG (GREY) 	Tandem Starter Unit Urethane Arm Caps W 24 ¹ / ₂ D 25 ¹ / ₂ H 33 ¹ / ₂ Seat Height 18 Inside Seat Width 20 Inside Seat Depth 19 Arm Height 25 ¹ / ₂ 1 ¹ / ₂ Yds. 34 lbs. COL 30 Sq. Ft. TB 133, add \$72 List	1038	1124	1144	1180	1216	1251	1287	1320	1357	1522	1643	1761
3420-AO-UB (BLACK) 3420-AO-UG (GREY) 	Tandem Add-On Unit Urethane Arm Cap W 22 ¹ / ₂ D 25 ¹ / ₂ H 33 ¹ / ₂ Seat Height 18 Inside Seat Width 20 Inside Seat Depth 19 Arm Height 25 ¹ / ₂ 1 ¹ / ₂ Yds. 31 lbs. COL 30 Sq. Ft. TB 133, add \$72 List	894	980	1000	1036	1072	1107	1143	1176	1213	1378	1499	1617
3420-EU-UB (BLACK) 3420-EU-UG (GREY) 	Tandem End Unit Urethane Arm Cap W 22 ¹ / ₂ D 25 ¹ / ₂ H 33 ¹ / ₂ Seat Height 18 Inside Seat Width 20 Inside Seat Depth 19 Arm Height 25 ¹ / ₂ 1 ¹ / ₂ Yds. 31 lbs. COL 30 Sq. Ft. TB 133, add \$72 List	894	980	1000	1036	1072	1107	1143	1176	1213	1378	1499	1617

Connecting Tables Page 7
 Bariatric Models Pages 10-13

OPTIONS (XXXX - REFERS TO CHAIR MODEL NUMBER)

MODEL	DESCRIPTION	LIST
XXXX-SC01	Replaceable Seat Cover (per seat)	45
XXXX-BC01	Replaceable Back Cover (per back)	30
XXXX-MB01	Moisture Barrier (seat only, per seat)	50
XXXX-NS02A	Non-Skid Glides (per arm frame)	10



REPRISE GUEST-TANDEM

designed by david dahl

NOTES:

- To build tandem configurations, always specify units from left-to-right as facing.
- Starter units (“-ST”) represent the first seating model in a configuration with subsequent modular units building onto them towards the right.
- Bariatric Add-On units (“-AO”) can only be added next to non-bariatric Tandem Seating Starter and Add-On units (two bariatric chairs cannot be adjoined together side-by-side).
- End-units (“-EU”) represent the final seating model in a configuration.
- Center tables are for in-line placement only (cannot start or end a configuration) and include arm frame for connecting purposes. To add seating units, subsequent chair will always be the 'AO' (add-on) or 'EU' (end unit).
- **Bariatric tandem chairs cannot be adjoined together side-by-side.**
- For Corian arm caps, please specify “-CO” in place of the “-W” after model number (with color selection) and refer to options below for upcharge.

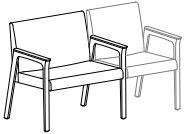
SIN #711-17

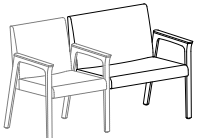
MODEL NUMBER	PRODUCT SPECIFICATIONS	FABRIC GRADES							LEATHER GRADES				
		COM	1	2	COL 3	4	5	6	7	8	L1	L2	L3
3440-ST-W	 <p>Tandem Bariatric Starter Unit 34" Wide, Wood Arm Caps W 34 D 25¹/₂ H 33¹/₂ Seat Height 18 Inside Seat Width 30 Inside Seat Depth 19 Arm Height 25¹/₂ 2¹/₂ Yds. 45 lbs. COL 50 Sq. Ft. TB 133, add \$120 List</p>	1343	1485	1519	1580	1640	1698	1758	1813	1874	2149	2351	2548
3440-AO-W	 <p>Tandem Bariatric Add-On Unit 34" Wide, Wood Arm Cap W 32 D 25¹/₂ H 33¹/₂ Seat Height 18 Inside Seat Width 30 Inside Seat Depth 19 Arm Height 25¹/₂ 2¹/₂ Yds. 41 lbs. COL 50 Sq. Ft. TB 133, add \$120 List</p>	1144	1286	1320	1381	1441	1499	1559	1614	1675	1950	2152	2349
3440-EU-W	 <p>Tandem Bariatric End Unit 34" Wide, Wood Arm Cap W 32 D 25¹/₂ H 33¹/₂ Seat Height 18 Inside Seat Width 30 Inside Seat Depth 19 Arm Height 25¹/₂ 2¹/₂ Yds. 41 lbs. COL 50 Sq. Ft. TB 133, add \$120 List</p>	1144	1286	1320	1381	1441	1499	1559	1614	1675	1950	2152	2349

Connecting Tables Page 7
 Tandem Seating Pages 8-9

OPTIONS (XXXX - REFERS TO CHAIR MODEL NUMBER)

MODEL	DESCRIPTION	LIST
XXXX-CO	Corian Arm Caps (per arm)	130
XXXX-SC02	Replaceable Seat Cover (per seat)	60
XXXX-BC02	Replaceable Back Cover (per back)	45
XXXX-MB02	Moisture Barrier (seat only, per seat)	95
XXXX-NS02A	Non-Skid Glides (per arm frame)	10



NOTES:

- To build tandem configurations, always specify units from left-to-right as facing.
- Starter units (“-ST”) represent the first seating model in a configuration with subsequent modular units building onto them towards the right.
- Bariatric Add-On units (“-AO”) can only be added next to non-bariatric Tandem Seating Starter and Add-On units (two bariatric chairs cannot be adjoined together side-by-side).
- End-units (“-EU”) represent the final seating model in a configuration.
- Center tables are for in-line placement only (cannot start or end a configuration) and include arm frame for connecting purposes. To add seating units, subsequent chair will always be the 'AO' (add-on) or 'EU' (end unit).
- **Bariatric tandem chairs cannot be adjoined together side-by-side.**
- Urethane arm caps available in Grey or Black.

REPRISE GUEST-TANDEM

designed by david dahl

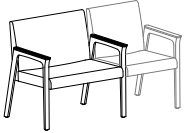
SIN #711-17

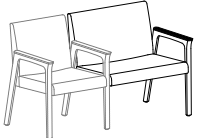
MODEL NUMBER	PRODUCT SPECIFICATIONS	FABRIC GRADES							LEATHER GRADES				
		COM	1	2	COL 3	4	5	6	7	8	L1	L2	L3
3440-ST-UB (BLACK) 3440-ST-UG (GREY) 	Tandem Bariatric Starter Unit 34" Wide, Urethane Arm Caps W 34 D 25 ¹ / ₂ H 33 ¹ / ₂ Seat Height 18 Inside Seat Width 30 Inside Seat Depth 19 Arm Height 25 ¹ / ₂ 2 ¹ / ₂ Yds. 45 lbs. COL 50 Sq. Ft. TB 133, add \$120 List	1383	1525	1559	1620	1680	1738	1798	1853	1914	2189	2391	2588
3440-AO-UB (BLACK) 3440-AO-UG (GREY) 	Tandem Bariatric Add-On Unit 34" Wide, Urethane Arm Cap W 32 D 25 ¹ / ₂ H 33 ¹ / ₂ Seat Height 18 Inside Seat Width 30 Inside Seat Depth 19 Arm Height 25 ¹ / ₂ 2 ¹ / ₂ Yds. 41 lbs. COL 50 Sq. Ft. TB 133, add \$120 List	1164	1306	1340	1401	1461	1519	1579	1634	1695	1970	2172	2369
3440-EU-UB (BLACK) 3440-EU-UG (GREY) 	Tandem Bariatric End Unit 34" Wide, Urethane Arm Cap W 32 D 25 ¹ / ₂ H 33 ¹ / ₂ Seat Height 18 Inside Seat Width 30 Inside Seat Depth 19 Arm Height 25 ¹ / ₂ 2 ¹ / ₂ Yds. 41 lbs. COL 50 Sq. Ft. TB 133, add \$120 List	1164	1306	1340	1401	1461	1519	1579	1634	1695	1970	2172	2369

Connecting Tables Page 7
Tandem Seating Pages 8-9

OPTIONS (XXXX - REFERS TO CHAIR MODEL NUMBER)

MODEL	DESCRIPTION	LIST
XXXX-SC02	Replaceable Seat Cover (per seat)	60
XXXX-BC02	Replaceable Back Cover (per back)	45
XXXX-MB02	Moisture Barrier (seat only, per seat)	95
XXXX-NS02A	Non-Skid Glides (per arm frame)	10



REPRISE GUEST-TANDEM

designed by david dahl

NOTES:

- To build tandem configurations, always specify units from left-to-right as facing.
- Starter units (“-ST”) represent the first seating model in a configuration with subsequent modular units building onto them towards the right.
- Bariatric Add-On units (“-AO”) can only be added next to non-bariatric Tandem Seating Starter and Add-On units (two bariatric chairs cannot be adjoined together side-by-side).
- End-units (“-EU”) represent the final seating model in a configuration.
- Center tables are for in-line placement only (cannot start or end a configuration) and include arm frame for connecting purposes. To add seating units, subsequent chair will always be the 'AO' (add-on) or 'EU' (end unit).
- **Bariatric tandem chairs cannot be adjoined together side-by-side.**
- For Corian arm caps, please specify “-CO” in place of the “-W” after model number (with color selection) and refer to options below for upcharge.

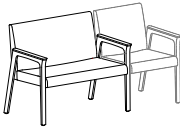
SIN #711-17

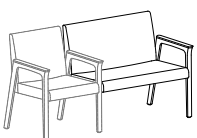
MODEL NUMBER	PRODUCT SPECIFICATIONS	FABRIC GRADES							LEATHER GRADES				
		COM	1	2	COL 3	4	5	6	7	8	L1	L2	L3
3445-ST-W 	Tandem Bariatric Starter Unit 40" Wide, Wood Arm Caps W 40 D 25 ¹ / ₂ H 33 ¹ / ₂ Seat Height 18 Inside Seat Width 33 Inside Seat Depth 19 Arm Height 25 ¹ / ₂ 2 ¹ / ₂ Yds. 68 lbs. COL 50 Sq. Ft. TB 133, add \$120 List	1522	1664	1698	1759	1819	1877	1937	1992	2053	2328	2530	2727
3445-AO-W 	Tandem Bariatric Add-On Unit 40" Wide, Wood Arm Cap W 38 D 25 ¹ / ₂ H 33 ¹ / ₂ Seat Height 18 Inside Seat Width 33 Inside Seat Depth 19 Arm Height 25 ¹ / ₂ 2 ¹ / ₂ Yds. 64 lbs. COL 50 Sq. Ft. TB 133, add \$120 List	1335	1477	1511	1572	1632	1690	1750	1805	1866	2141	2343	2540
3445-EU-W 	Tandem Bariatric End Unit 40" Wide, Wood Arm Cap W 38 D 25 ¹ / ₂ H 33 ¹ / ₂ Seat Height 18 Inside Seat Width 33 Inside Seat Depth 19 Arm Height 25 ¹ / ₂ 2 ¹ / ₂ Yds. 64 lbs. COL 50 Sq. Ft. TB 133, add \$120 List	1335	1477	1511	1572	1632	1690	1750	1805	1866	2141	2343	2540

Connecting Tables Page 7
 Tandem Seating Pages 8-9

OPTIONS (XXXX - REFERS TO CHAIR MODEL NUMBER)

MODEL	DESCRIPTION	LIST
XXXX-CO	Corian Arm Caps (per arm)	130
XXXX-SC02	Replaceable Seat Cover (per seat)	60
XXXX-BC02	Replaceable Back Cover (per back)	45
XXXX-MB02	Moisture Barrier (seat only, per seat)	95
XXXX-NS02A	Non-Skid Glides (per arm frame)	10

NOTES:

- To build tandem configurations, always specify units from left-to-right as facing.
- Starter units (“-ST”) represent the first seating model in a configuration with subsequent modular units building onto them towards the right.
- Bariatric Add-On units (“-AO”) can only be added next to non-bariatric Tandem Seating Starter and Add-On units (two bariatric chairs cannot be adjoined together side-by-side).
- End-units (“-EU”) represent the final seating model in a configuration.
- Center tables are for in-line placement only (cannot start or end a configuration) and include arm frame for connecting purposes. To add seating units, subsequent chair will always be the 'AO' (add-on) or 'EU' (end unit).
- **Bariatric tandem chairs cannot be adjoined together side-by-side.**
- Urethane arm caps available in Grey or Black.

REPRISE GUEST-TANDEM

designed by david dahl

SIN #711-17

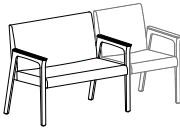
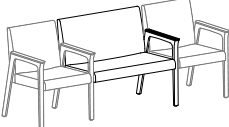
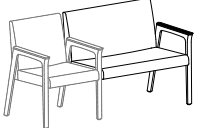
MODEL NUMBER	PRODUCT SPECIFICATIONS	FABRIC GRADES							LEATHER GRADES				
		COM	1	2	COL 3	4	5	6	7	8	L1	L2	L3
3445-ST-UB (BLACK) 3445-ST-UG (GREY) 	Tandem Bariatric Starter Unit 40" Wide, Urethane Arm Caps W 40 D 25 ¹ / ₂ H 33 ¹ / ₂ Seat Height 18 Inside Seat Width 33 Inside Seat Depth 19 Arm Height 25 ¹ / ₂ 2 ¹ / ₂ Yds. 68 lbs. COL 50 Sq. Ft. TB 133, add \$120 List	1562	1704	1738	1799	1859	1917	1977	2032	2093	2368	2570	2767
3445-AO-UB (BLACK) 3445-AO-UG (GREY) 	Tandem Bariatric Add-On Unit 40" Wide, Urethane Arm Cap W 38 D 25 ¹ / ₂ H 33 ¹ / ₂ Seat Height 18 Inside Seat Width 33 Inside Seat Depth 19 Arm Height 25 ¹ / ₂ 2 ¹ / ₂ Yds. 64 lbs. COL 50 Sq. Ft. TB 133, add \$120 List	1375	1517	1551	1612	1672	1730	1790	1845	1906	2181	2383	2580
3445-EU-UB (BLACK) 3445-EU-UG (GREY) 	Tandem Bariatric End Unit 40" Wide, Urethane Arm Cap W 38 D 25 ¹ / ₂ H 33 ¹ / ₂ Seat Height 18 Inside Seat Width 33 Inside Seat Depth 19 Arm Height 25 ¹ / ₂ 2 ¹ / ₂ Yds. 64 lbs. COL 50 Sq. Ft. TB 133, add \$120 List	1375	1517	1551	1612	1672	1730	1790	1845	1906	2181	2383	2580

Connecting Tables Page 7
Tandem Seating Pages 8-9

OPTIONS (XXXX - REFERS TO CHAIR MODEL NUMBER)

MODEL	DESCRIPTION	LIST
XXXX-SC02	Replaceable Seat Cover (per seat)	60
XXXX-BC02	Replaceable Back Cover (per back)	45
XXXX-MB02	Moisture Barrier (seat only, per seat)	95
XXXX-NS02A	Non-Skid Glides (per arm frame)	10

REPRISE GUEST-TANDEM

designed by david dahl



SIN #711-17

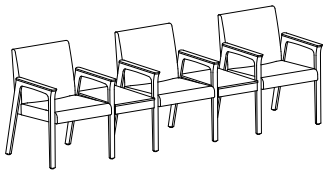

Qty	Model #	Description	COM List
1	3420-ST-W	Tandem Starter Unit	\$998
2	3417-15	15" Center In-Line Table (\$514 List each)	\$1,028
1	3420-AO-W	Tandem Add-On Unit	\$874
1	3420-EU-W	Tandem End Unit	\$874
			\$3,774

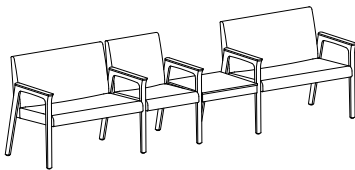

Qty	Model #	Description	COM List
1	3440-ST-W	Tandem 34" Wide Bariatric Starter Unit	\$1,343
1	3420-AO-W	Tandem Add-On Unit	\$874
1	3417-21	21" Center In-Line Table	\$581
1	3440-EU-W	34" Wide Bariatric End Unit	\$1,144
			\$3,942

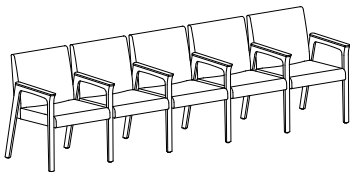

Qty	Model #	Description	COM List
1	3420-ST-W	Tandem Starter Unit	\$998
3	3420-AO-W	Tandem Add-On Unit (\$874 List each)	\$2,622
1	3420-EU-W	Tandem End Unit	\$874
			\$4,494

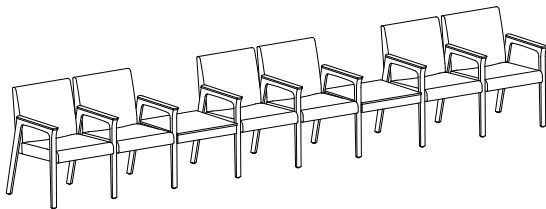

Qty	Model #	Description	COM List
1	3420-ST-W	Tandem Starter Unit	\$998
4	3420-AO-W	Tandem Add-On Unit (\$874 List each)	\$3,496
2	3417-21	21" Center In-Line Table (\$581 List each)	\$1,162
1	3420-EU-W	Tandem End Unit	\$874
			\$6,530

NOTES:

- Beech hardwood frame.
- Four arm cap options: Beech wood, black urethane, grey urethane or Corian.
- Urethane arm caps available in Grey or Black.
- For Corian arm caps, please specify “-CO” in place of the “-W” after model number (with color selection) and refer to options below for upcharge.
- Refer to page 20 for two-tone upholstery examples and yardage requirements.

SPECIFY:

1. Model number
2. Arm cap finish, as applicable
3. Frame finish
4. Upholstery selection
5. Options, as applicable

ORDERING EXAMPLE:

#3450-W-SC01

Patient Chair
Wood Arm Caps
Replaceable Seat Cover

REPRISE GUEST-TANDEM

designed by david dahl

SIN #711-17

MODEL NUMBER	PRODUCT SPECIFICATIONS	FABRIC GRADES							LEATHER GRADES				
		COM	1	2	COL 3	4	5	6	7	8	L1	L2	L3
3450-W	Patient Chair Wood Arm Caps W 24 ¹ / ₂ D 25 ¹ / ₂ H 44 Seat Height 18 Inside Seat Width 20 Inside Seat Depth 19 Arm Height 25 ¹ / ₂ 2 ¹ / ₄ Yds. 37 lbs. COL 45 Sq. Ft. TB 133, add \$108 List	1118	1246	1277	1331	1385	1437	1492	1541	1596	1844	2026	2203
3450-UB (BLACK) 3450-UG (GREY)	Patient Chair Urethane Arm Caps W 24 ¹ / ₂ D 25 ¹ / ₂ H 44 Seat Height 18 Inside Seat Width 20 Inside Seat Depth 19 Arm Height 25 ¹ / ₂ 2 ¹ / ₄ Yds. 37 lbs. COL 45 Sq. Ft. TB 133, add \$108 List	1158	1286	1317	1371	1425	1477	1532	1581	1636	1884	2066	2243

OPTIONS (XXXX - REFERS TO CHAIR MODEL NUMBER)

MODEL	DESCRIPTION	LIST
XXXX-CO	Corian Arm Caps (add to model #3450-W)	260
XXXX-SC01	Replaceable Seat Cover	45
XXXX-MB01	Moisture Barrier	50
XXXX-NS02B	Non-Skid Glides	20

REPRISE GUEST-TANDEM

designed by david dahl

NOTES:

- Beech hardwood frame.
- Four arm cap options: Beech wood, black urethane, grey urethane or Corian.
- Urethane arm caps available in Grey or Black.
- For Corian arm caps, please specify “-CO” in place of the “-W” after model number (with color selection) and refer to options below for upcharge.
- Brushed Stainless Steel foot step is positioned 6¹/₂” from the floor.
- Refer to page 20 for two-tone upholstery examples and yardage requirements.

SPECIFY:

1. Model number
2. Arm cap finish, as applicable
3. Frame finish
4. Upholstery selection
5. Options, as applicable

ORDERING EXAMPLE:

#3457-UB-NS02B

Easy Access/Hip Chair
Black Urethane Arm Caps
Non-Skid Glides

SIN #711-17

MODEL NUMBER	PRODUCT SPECIFICATIONS	FABRIC GRADES							LEATHER GRADES				
		COM	1	2	COL			8	L1	L2	L3		
3457-W	Easy Access/Hip Chair Wood Arm Caps W 24 ¹ / ₂ D 25 ¹ / ₂ H 39 ¹ / ₂ Seat Height 25 Inside Seat Width 20 Inside Seat Depth 19 Arm Height 32 ¹ / ₂ 1 ¹ / ₂ Yds. 40 lbs. COL 30 Sq. Ft. TB 133, add \$72 List	1377	1463	1483	1519	1555	1590	1626	1659	1696	1861	1982	2100
3457-UB (BLACK) 3457-UG (GREY)	Easy Access/Hip Chair Urethane Arm Caps W 24 ¹ / ₂ D 25 ¹ / ₂ H 39 ¹ / ₂ Seat Height 25 Inside Seat Width 20 Inside Seat Depth 19 Arm Height 32 ¹ / ₂ 1 ¹ / ₂ Yds. 40 lbs. COL 30 Sq. Ft. TB 133, add \$72 List	1417	1503	1523	1559	1595	1630	1666	1699	1736	1901	2022	2140

OPTIONS (XXXX - REFERS TO CHAIR MODEL NUMBER)

MODEL	DESCRIPTION	LIST
XXXX-CO	Corian Arm Caps (add to model #3457-W)	260
XXXX-SC01	Replaceable Seat Cover	45
XXXX-BC01	Replaceable Back Cover	30
XXXX-MB01	Moisture Barrier (seat only)	50
XXXX-NS02B	Non-Skid Glides	20

NOTES:

- Concealed velcro attachment.
- Replacement seat and back covers can be easily field installed on previously ordered Reprise models with replaceable cover option.
- Reprise models originally ordered with standard fixed upholstery can utilize replacement seat and/or back covers, however some upholstery work will be required to remove original upholstery covers.

SPECIFY:

1. Model number
2. Upholstery selection



ORDERING EXAMPLE:

#RBC-3410
Replacement Back Cover

REPRISE GUEST-TANDEM

designed by david dahl

SIN #711-17

MODEL NUMBER	PRODUCT SPECIFICATIONS	FABRIC GRADES								LEATHER GRADES			
		COM	1	2	COL 3	4	5	6	7	8	L1	L2	L3
RSC-3410 	Replacement Upholstered Seat Cover 1 Yd. COL 20 Sq. Ft. TB 133, add \$48 List Applies to: 3410 Guest 3420 Tandem 3450 Patient Chair 3457 Easy Access/Hip Chair	91	148	162	186	210	233	257	279	304	414	495	573
RBC-3410 	Replacement Upholstered Back Cover 1 Yd. COL 20 Sq. Ft. TB 133, add \$48 List Applies to: 3410 Guest 3420 Tandem 3457 Easy Access/Hip Chair	102	159	173	197	221	244	268	290	315	425	506	584

REPRISE GUEST-TANDEM

designed by david dahl

NOTES:

- Concealed velcro attachment.
- Replacement seat and back covers can be easily field installed on previously ordered Reprise models with replaceable cover option.
- Reprise models originally ordered with standard fixed upholstery can utilize replacement seat and/or back covers, however some upholstery work will be required to remove original upholstery covers.

SPECIFY:

1. Model number
2. Upholstery selection

ORDERING EXAMPLE:

#RBC-3440
34" Wide Bariatric Settee
Replacement Back Cover

SIN #711-17

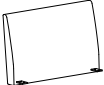
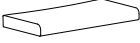
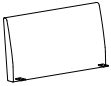
MODEL NUMBER	PRODUCT SPECIFICATIONS	FABRIC GRADES							LEATHER GRADES				
		COM	1	2	COL 3	4	5	6	7	8	L1	L2	L3
RSC-3440 	34" Wide Bariatric Settee Replacement Upholstered Seat Cover 1 Yd. COL 20 Sq. Ft. TB 133, add \$48 List	144	201	215	239	263	286	310	332	357	467	548	626
RBC-3440 	34" Wide Bariatric Settee Replacement Upholstered Back Cover 1 1/2 Yds. COL 30 Sq. Ft. TB 133, add \$72 List	143	229	249	285	321	356	392	425	462	627	748	866
RSC-3445 	40" Wide Bariatric Settee Replacement Upholstered Seat Cover 1 1/4 Yds. COL 25 Sq. Ft. TB 133, add \$60 List	144	215	232	263	293	322	352	379	410	547	648	747
RBC-3445 	40" Wide Bariatric Settee Replacement Upholstered Back Cover 1 1/2 Yds. COL 30 Sq. Ft. TB 133, add \$72 List	144	230	250	286	322	357	393	426	463	628	749	867

NOTES:

- Replacement hardware included with replacement arm frames.
- Urethane arm caps available in Grey or Black.

SPECIFY:

1. Model number
2. Arm frame/cap finish, as applicable



ORDERING EXAMPLE:

#3410-05R-NS02A
Replacement Wood Frame
Non-Skid Glides

**REPRISE
GUEST-TANDEM**

designed by david dahl

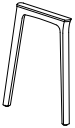
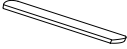
SIN #711-17

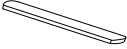
		LIST
<p>3410-05R (RIGHT ARM, AS SEATED) 3410-05C (CENTER ARM, AS SEATED) 3410-05L (LEFT ARM, AS SEATED)</p> 	<p>Replacement Guest Chair No Arm Cap 8 lbs.</p>	167
<p>3410-07W (WOOD)</p> 	<p>Replacement Wood Arm Cap 2 lbs.</p>	77
<p>3410-07UB (BLACK) 3410-07UG (GREY)</p> 	<p>Replacement Urethane Arm Cap, Black or Grey 2 lbs.</p>	77
<p>6410-07C (CORIAN)</p> 	<p>Replacement Corian Arm Cap (standard colors only) 2 lbs.</p>	182

OPTIONS (XXXX - REFERS TO COMPONENT MODEL NUMBER)

MODEL	DESCRIPTION	LIST
XXXX-NS02A	Non-Skid Glides (per unit)	10

REPRISE GUEST-TANDEM

designed by david dahl

UPHOLSTERY COMBINATIONS:

For fabric, vinyl or leather upholstery combinations, refer to the pricing below:

- When combining **two** COM/COV/COL fabrics, or fabrics with the same grade, add the following (per unit):
 - › \$45 List for guest, patient and hip chairs
 - › \$65 List for bariatric chairs
- When combining **three or more** COM/COV/COL fabrics, or fabrics with the same grade, add the following (per unit):
 - › \$55 List for guest, patient and hip chairs
 - › \$75 List for bariatric chairs
- When combining different grades of fabric, price will be based on the highest grade specified.
- Two-tone upholstery examples and yardage requirements for the most common combinations are listed below. Additional combinations available, please contact Customer Service for yardage requirements and pricing.
- Note: Yardage amounts are based on fabric which is plain (i.e. non-directional) and a full 54" wide.
- **Appropriate upholstery code must be included on order.**

SIN #711-17



Code	RE1
<u>Models</u>	<u>COM Requirement</u>
All Guest & Easy Access/Hip ChairUnits	Seat = 1 yd. Back = 1 yds.



Code	RE2
<u>Models</u>	<u>COM Requirement</u>
All 34" W Bariatric Units	Seat = 1 yd. Back = 1 ¹ / ₂ yds.

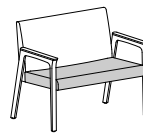

Code	RE3
<u>Models</u>	<u>COM Requirement</u>
All 40" W Bariatric Units	Seat = 1 ¹ / ₄ yds. Back = 1 ¹ / ₂ yds.



Code	RE4
<u>Models</u>	<u>COM Requirement</u>
3450-W 3450-U	Seat = 1 ¹ / ₄ yds. Back = 2 ¹ / ₄ yds.

NOTES:

- Tables manufactured in Beech wood.
- All tables feature veneer tops as standard. Laminate and Corian tops available.
- For Corian top, specify “-CO” next to model number. Corian top is 1/2" thick in lieu of standard table top thickness of 3/4" .
- All standard and custom wood finishes available on Beech. For custom wood finishes, please add \$400 List per color per order.
- When ordering in laminate, specify laminate manufacturer, color and pattern number.
- For custom laminates, add \$500 List per color per order. Pre-approval required, please contact Customer Service.

SPECIFY:

1. Model number
2. Top finish
3. Wood leg finish

ORDERING EXAMPLE:

#3400-2420-CO



24" Round Table, Wood Legs
Corian Top

REPRISE
OCCASIONAL TABLES

designed by david dahl



SIN #711-11

MODEL NUMBER	PRODUCT SPECIFICATIONS	TABLE TOP FINISH			
		MODEL NUMBER	VENEER OR LAMINATE	CORIAN (-CO)	WEIGHT
3400 	Round Table 18" Dia. x 20" H 24" Dia. x 20" H 30" Dia. x 20" H 36" Dia. x 16" H 36" Dia. x 20" H	3400-1820	1055	1346	14
		3400-2420	1086	1648	17
		3400-3020	1219	2095	26
		3400-3616	1484	2937	31
		3400-3620	1425	2834	32
	Square/Rectangle Table 18" W x 18" L x 20" H 24" W x 24" L x 20" H 30" W x 30" L x 20" H 36" W x 36" L x 20" H 36" W x 36" L x 16" H 48" W x 20" L x 16" H	3400-181820	973	1295	16
		3400-242420	1033	1595	19
		3400-303020	1168	2045	29
		3400-363620	1412	2863	34
		3400-363616	1353	2762	35
		3400-482016	1358	2295	41

CORIAN® TOP COLORS:

- Designer White
- Linen
- Rain Cloud
- Witch Hazel

Please note all dimensions listed above are nominal.

ROADSTER LOUNGE

designed by pld design group



SIN #711-16

PRODUCT FEATURES:

- Arm and armless models.
- Available with fixed legs, casters, or in combination.
- Metal leg height measures $7\frac{1}{4}$ " in front and $6\frac{1}{4}$ " in back.
- Legs available in standard and premium metal finishes, refer to options below.
- Non-skid glides available for hard surface floors. Please specify "NS01" after model number and add \$20 List per unit.
- Mobile version comes standard with two locking casters in rear and two non-locking casters in front.
- Casters offered in silver finish only. Leg finish will be Metallic Silver to match unless otherwise specified.
- Units with fixed leg/caster combination, casters will be non-locking unless otherwise specified.
- Soft-tread casters available, silver color only. Please specify "C05" and add \$50 List per set (includes 4 casters).
- Optional pull available on back of mobile lounge chairs only, please specify "P01" next to model number and add \$50 List per unit. Satin nickel finish.
- 350 lbs. maximum weight capacity.
- Two-tone upholstery examples, yardage requirements and pricing featured on page 5.
- All dimensions are nominal.

STANDARD FINISH COLORS:

#06 Charcoal Grey
#90 Metallic Silver

PREMIUM METAL FINISH COLORS:

#07 Gold Shimmer
#08 Penny
#09 Brown Sugar
#83 Metallic Champagne
#94 Cotton

ROTATING TABLET FEATURES:

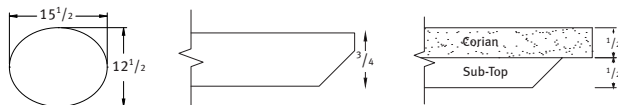

Tablet Shape

Veneer/Laminate Top - Edge Profile

Corian Top - Edge Profile

- Tablet affixed to right or left arm/side as specified.
- Tablet size is $15\frac{1}{2}$ " W x $12\frac{1}{2}$ " D x $\frac{3}{4}$ " thick with 360-degree turning radius.
- Three tablet surface options: veneer, laminate and Corian.
- Veneer offered in Maple, Walnut and White Oak, in all standard and custom wood finishes.
- For custom wood finishes, please add one-time upcharge of \$400 List per color per order.
- Laminate is applied to tablet top surface only.
- For standard laminates, refer to Standard Finish Card.
- For custom laminates, add \$500 List per color per order. Pre-approval required, please contact Customer Service.
- Corian available in four standard colors. For non-standard options, please contact Customer Service for pricing.
- For maximum durability, a laminate or Corian surface with a clear coat edge finish is recommended.
- Tablet mounting post available in #06 Charcoal Grey and #90 Metallic Silver finishes.
- Tablet mounting post will match leg finish unless otherwise specified (including premium finish selections).

ROADSTER LOUNGE

designed by pld design group



SIN #711-16

CORIAN® COLORS:

- Designer White
- Linen
- Rain Cloud
- Witch Hazel

Corian® is a registered trademark of Dupont.

TABLET EDGE FINISH SPECIFICATIONS:

- For veneer tops, edge finish will always match the top finish color, unless otherwise specified.
- For standard laminate tops (laminate cannot be applied to the edge):
 - › Wood grain laminates, edge finish will match the laminate top color, unless otherwise specified.
 - › Solid color laminates, edge finish will be natural (clear coat) as standard, unless otherwise specified.
- For Corian tops:
 - › Designer White, Rain Cloud and Linen colors, edge will be white as standard, unless otherwise specified.
 - › Witch Hazel, edge will be natural (clear coat) as standard, unless otherwise specified.
- Edges are also available in all standard wood finishes, please specify. For custom edge finishes, please add one-time upcharge of \$400 List per color, per order.

POWER UNITS:

- Unit affixed to right side, as seated, unless otherwise specified.
- If specified in conjunction with a tablet, unit will be mounted to same side as tablet, unless otherwise specified.
- PB1 and PB2 dimensions: 5³/₄" W x 2¹/₂" D
- PB3 dimensions: 6¹/₂" W x 2¹/₂" D
- Metallic Silver or White finish with 108" electrical cord.
- UL listed.
- **Not available on units with casters.**



PB1

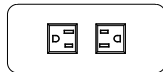

PB2

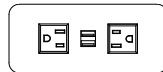

PB3

- PB1 unit features one outlet and two USB charging ports.
- PB2 unit features two outlets.
- PB3 unit features two outlets and two USB charging ports.

NOTES:

- Available with fixed legs, casters, or in combination.
- Fixed metal legs available in standard and premium metal finishes.
- Casters offered in silver finish only. Leg finish will be Metallic Silver to match unless otherwise specified.
- Units with fixed leg/caster combination, casters will be non-locking unless otherwise specified.
- Tablet mounting post will match leg finish unless otherwise specified.
- Refer to page 5 for two-tone upholstery examples and yardage requirements.

SPECIFY:

1. Model number
2. Leg finish
3. Upholstery selection
4. Options, as applicable

ORDERING EXAMPLE:

#4285-TAR03-C05



Armless Lounge, Casters
Veneer Tablet, Right
Soft Tread Casters

ROADSTER LOUNGE

designed by pld design group

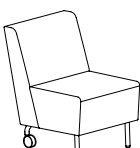

SIN #711-16

MODEL NUMBER	PRODUCT SPECIFICATIONS	FABRIC GRADES							LEATHER GRADES				
		COM	1	2	COL 3	4	5	6	7	8	L1	L2	L3
4280 	Lounge Chair, Armless, Fixed Legs W 22 ¹ / ₂ D 28 ¹ / ₂ H 29 ¹ / ₂ Seat Height 18 Inside Seat Width 22 ¹ / ₂ Inside Seat Depth 19 2 ¹ / ₂ Yds. 28 lbs. COL 50 Sq. Ft. TB 133, add \$120 List	1104	1246	1280	1341	1401	1459	1519	1574	1635	1910	2112	2309
4285 	Lounge Chair, Armless, Casters W 22 ¹ / ₂ D 28 ¹ / ₂ H 29 ¹ / ₂ Seat Height 18 Inside Seat Width 22 ¹ / ₂ Inside Seat Depth 19 2 ¹ / ₂ Yds. 28 lbs. COL 50 Sq. Ft. TB 133, add \$120 List	1192	1334	1368	1429	1489	1547	1607	1662	1723	1998	2200	2397
4285-CF 	Lounge Chair, Armless, Casters Front, Fixed Legs Rear W 22 ¹ / ₂ D 28 ¹ / ₂ H 29 ¹ / ₂ Seat Height 18 Inside Seat Width 22 ¹ / ₂ Inside Seat Depth 19 2 ¹ / ₂ Yds. 28 lbs. COL 50 Sq. Ft. TB 133, add \$120 List	1192	1334	1368	1429	1489	1547	1607	1662	1723	1998	2200	2397
4285-CR 	Lounge Chair, Armless, Fixed Legs Front, Casters Rear W 22 ¹ / ₂ D 28 ¹ / ₂ H 29 ¹ / ₂ Seat Height 18 Inside Seat Width 22 ¹ / ₂ Inside Seat Depth 19 2 ¹ / ₂ Yds. 28 lbs. COL 50 Sq. Ft. TB 133, add \$120 List	1192	1334	1368	1429	1489	1547	1607	1662	1723	1998	2200	2397

OPTIONS (XXXX - REFERS TO CHAIR MODEL NUMBER)

MODEL	DESCRIPTION	LIST
XXXX-TAR03	Veneer/Laminate Rotating Tablet, Right (as seated)	383
XXXX-TAL03	Veneer/Laminate Rotating Tablet, Left (as seated)	383
XXXX-TAR03-CO	Corian Rotating Tablet, Right (as seated)	686
XXXX-TAL03-CO	Corian Rotating Tablet, Left (as seated)	686
XXXX-PB1-S, XXXX-PB1-W	Power Band 1 (one power, two USB), Silver or White	413
XXXX-PB2-S, XXXX-PB2-W	Power Band 2 (dual power), Silver or White	322
XXXX-PB3-S, XXXX-PB3-W	Power Band 3 (dual power, two USB), Silver or White	429
XXXX-NS01	Non-Skid Glides	20
XXXX-C05	Soft Tread Casters (set of 4)	50
XXXX-PF02	Premium Leg Finish	80
XXXX-P01	Pull Handle (when specified with casters)	50

ROADSTER LOUNGE

designed by pld design group



SIN #711-16

NOTES:

- Available with fixed legs, casters, or in combination.
- Fixed metal legs available in standard and premium metal finishes.
- Casters offered in silver finish only. Leg finish will be Metallic Silver to match unless otherwise specified.
- Units with fixed leg/caster combination, casters will be non-locking unless otherwise specified.
- Tablet mounting post will match leg finish unless otherwise specified.
- Refer to page 5 for two-tone upholstery examples and yardage requirements.



SPECIFY:

1. Model number
2. Leg finish
3. Upholstery selection
4. Options, as applicable

ORDERING EXAMPLE:

#4295-TAL03-CO-P01

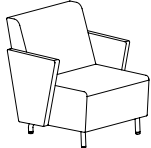
Lounge, Casters
Corian Tablet, Left
Pull Handle

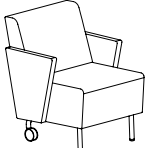
MODEL NUMBER	PRODUCT SPECIFICATIONS	FABRIC GRADES							LEATHER GRADES							
		COM	1	2	COL			4	5	6	7	8	L1	L2	L3	
4290 	Lounge Chair, Arms, Fixed Legs W 26 D 28 ¹ / ₂ H 29 ¹ / ₂ Seat Height 18 Inside Seat Width 22 ¹ / ₂ Inside Seat Depth 19 Arm Height 24 ³ / ₄ 3 ¹ / ₂ Yds. 48 lbs. COL 70 Sq. Ft. TB 133, add \$168 List	1338	1537	1585	1669	1754	1835	1919	1996	2081	2467	2750	3025			
4295 	Lounge Chair, Arms, Casters W 26 D 28 ¹ / ₂ H 29 ¹ / ₂ Seat Height 18 Inside Seat Width 22 ¹ / ₂ Inside Seat Depth 19 Arm Height 24 ³ / ₄ 3 ¹ / ₂ Yds. 48 lbs. COL 70 Sq. Ft. TB 133, add \$168 List	1428	1627	1675	1759	1844	1925	2009	2086	2171	2557	2840	3115			
4295-CF 	Lounge Chair, Arms, Casters Front, Fixed Legs Rear W 26 D 28 ¹ / ₂ H 29 ¹ / ₂ Seat Height 18 Inside Seat Width 22 ¹ / ₂ Inside Seat Depth 19 Arm Height 24 ³ / ₄ 3 ¹ / ₂ Yds. 48 lbs. COL 70 Sq. Ft. TB 133, add \$168 List	1428	1627	1675	1759	1844	1925	2009	2086	2171	2557	2840	3115			
4295-CR 	Lounge Chair, Arms, Fixed Legs Front, Casters Rear W 26 D 28 ¹ / ₂ H 29 ¹ / ₂ Seat Height 18 Inside Seat Width 22 ¹ / ₂ Inside Seat Depth 19 Arm Height 24 ³ / ₄ 3 ¹ / ₂ Yds. 48 lbs. COL 70 Sq. Ft. TB 133, add \$168 List	1428	1627	1675	1759	1844	1925	2009	2086	2171	2557	2840	3115			

OPTIONS (XXXX - REFERS TO CHAIR MODEL NUMBER)

MODEL	DESCRIPTION	LIST
XXXX-TAR03	Veneer/Laminate Rotating Tablet, Right (as seated)	383
XXXX-TAL03	Veneer/Laminate Rotating Tablet, Left (as seated)	383
XXXX-TAR03-CO	Corian Rotating Tablet, Right (as seated)	686
XXXX-TAL03-CO	Corian Rotating Tablet, Left (as seated)	686
XXXX-PB1-S, XXXX-PB1-W	Power Band 1 (one power, two USB), Silver or White	413
XXXX-PB2-S, XXXX-PB2-W	Power Band 2 (dual power), Silver or White	322
XXXX-PB3-S, XXXX-PB3-W	Power Band 3 (dual power, two USB), Silver or White	429
XXXX-NS01	Non-Skid Glides	20
XXXX-C05	Soft Tread Casters (set of 4)	50
XXXX-PF02	Premium Leg Finish	80
XXXX-P01	Pull Handle (when specified with casters)	50

UPHOLSTERY COMBINATIONS:

For fabric, vinyl or leather upholstery combinations, refer to the pricing below:

- When combining **two** COM/COV/COL fabrics, or fabrics with the same grade, add \$65 List per unit.
- When combining **three or more** COM/COV/COL fabrics, or fabrics with the same grade, add \$75 List per unit.
- When combining different grades of fabric, price will be based on the highest grade specified.

- Two-tone upholstery examples and yardage requirements for the most common combinations are listed below. Additional combinations available, please contact Customer Service for yardage requirements and pricing.
- Note: Yardage amounts are based on fabric which is plain (i.e. non-directional) and a full 54" wide.
- **Appropriate upholstery code must be included on order.**

ROADSTER LOUNGE

designed by pld design group



SIN #711-16

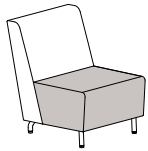

Code	RL1
<u>Model</u>	<u>COM Requirement</u>
4280	Seat Cushion Only = 1 yd.
4285	Balance of Chair = 1 ³ / ₄ yds.

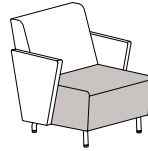

Code	RL2
<u>Model</u>	<u>COM Requirement</u>
4290	Seat Cushion Only = 1 yd.
4295	Balance of Chair = 2 ³ / ₄ yds.

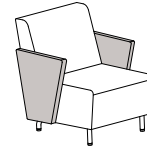

Code	RL3
<u>Model</u>	<u>COM Requirement</u>
4290	Arms Only = 1 ¹ / ₄ yds.
4295	Balance of Chair = 2 ¹ / ₄ yds.

NOTES:

- 10¹/₂" leg height clearance.
- Die-cast aluminum legs available in standard and premium metal finishes and feature adjustable glides.
- SPB3 power band available for under-seat placement center placement as standard.
- Power band features two white outlets and two USB charging ports inside custom housing unit. Black outlets available upon request.
- Housing unit available in Metallic Silver or White finish with 108" electrical cord.
- Refer to next page for two-tone upholstery examples and yardage requirements.
- All dimensions are nominal.

SPECIFY:

1. Model number
2. Leg finish
3. Upholstery selection
4. Options as applicable

ORDERING EXAMPLE:

#5423-NS12B

Three-Seat Bench
Non-Skid Glides

SAVINA BENCHES

designed by rainlight

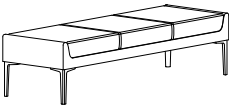

SIN #711-16

MODEL NUMBER	PRODUCT SPECIFICATIONS	FABRIC GRADES							LEATHER GRADES				
		COM	1	2	COL 3	4	5	6	7	8	L1	L2	L3
5422 	Q S Two-Seat Bench W 60 D 24 H 17 ³ / ₄ Seat Height 17 ¹ / ₂ 3 ³ / ₄ Yds. 57 lbs. COL 65 Sq. Ft. TB 133 add \$156 List	1413	1598	1642	1721	1799	1874	1953	2024	2103	2461	2724	2980
5423 	Q S Three-Seat Bench W 72 D 24 H 17 ³ / ₄ Seat Height 17 ¹ / ₂ 4 Yds. 85 lbs. COL 80 Sq. Ft. TB 133 add \$192 List	1816	2043	2098	2194	2291	2383	2480	2568	2665	3106	3429	3744

Standard Leg Finishes:
 #06 Charcoal Grey
 #90 Metallic Silver
 #92 Polished Aluminum
 #95 Satin Black

Premium Leg Finishes (add \$80 List):
 #07 Gold Shimmer
 #08 Penny
 #09 Brown Sugar
 #83 Metallic Champagne
 #94 Cotton

OPTIONS (XXXX - REFERS TO BENCH MODEL NUMBER)

MODEL	DESCRIPTION	LIST
XXXX-PF02	Premium Finish	80
XXXX-NS12B	Non-Skid Glides	20
UNDER SEAT PLACEMENT ONLY		
XXXX-SPB3-S	Power Band 3 (dual power, two USB) Silver	569
XXXX-SPB3-W	Power Band 3 (dual power, two USB) White	569

Q S = Available on Quick-Ship Program (standard leg finishes only).

SAVINA BENCHES

designed by rainlight



SIN #711-16

UPHOLSTERY COMBINATIONS:

For fabric vinyl or leather upholstery combinations refer to the pricing below:

- When combining **two** COM/COV/COL fabrics or fabrics with the same grade price will be \$65 List (per unit).
- When combining **three or more** COM/COV/COL fabrics or fabrics with the same grade price will be \$75 List (per unit).
- When combining different grades of fabric price will be based on the highest grade specified.
- Two-tone upholstery examples and yardage requirements for the most common combinations are listed below. Additional combinations available please contact Customer Service for yardage requirements and pricing.
- Note: Yardage amounts are based on fabric which is plain (i.e. non-directional) and a full 54" wide.
- **Appropriate upholstery code must be included on order.**

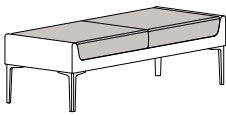

Code SV21

Models COM Requirement
5422 Seat Cushions Only = 2¹/₄ yds.
Balance of Bench = 1¹/₂ yd.

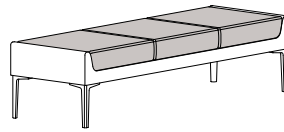

Code SV22

Models COM Requirement
5423 Seat Cushions Only = 2¹/₂ yds.
Balance of Bench = 1¹/₂ yds.



SAVINA LOUNGE/MODULAR

designed by rainlight



SIN #711-16

PRODUCT FEATURES:

- Single, two-seat, three-seat and love seat models.
- Fixed seat and back cushion.
- 10¹/₂" leg height clearance.
- Die-cast aluminum legs available in standard and premium metal finishes.
- Legs feature adjustable glides as standard for leveling purposes.
- Non-skid glides available for hard surface floors. Please specify “-NS12B” after model number and add \$20 List per unit.
- Maximum weight capacity: 350 lbs. for lounge chairs (per seat) and 700 lbs. for love seat.
- Under-seat power unit option available. Refer to next page for details.
- Please refer to page 5 for two-tone upholstery examples, yardage requirements and pricing.
- All dimensions are nominal.

STANDARD METAL FINISH COLORS:

#06 Charcoal Grey
#90 Metallic Silver
#92 Polished Aluminum
#95 Satin Black

PREMIUM METAL FINISH COLORS:

#07 Gold Shimmer
#08 Penny
#09 Brown Sugar
#83 Metallic Champagne
#94 Cotton

CONNECTING TABLES:

- In-line, corner and end tables available in Ash veneer, laminate or Corian.
- 3" table thickness.
- All standard and custom wood finishes available.
- For custom wood finishes, please add \$400 List per color per order.
- For veneer tops, edge finish will always match top finish color, unless otherwise specified.
- For standard laminates, refer to Standard Finish Card. Laminate top features laminate self edge.
- For custom laminates, add \$500 List per color per order. Pre-approval required, please contact Customer Service.
- Corian top available in four standard colors.
- Corner and end table leg available in standard and premium metal finishes.
- Legs feature adjustable glides as standard for leveling purposes.
- Non-skid glides available for hard surface floors. Please refer to page 4 for option code and pricing.
- Optional power units available on table top, refer to next page for additional details.
- All dimensions are nominal.

ASH WOOD FINISHES:

#162 White Oak on Ash	#165 Kona Ash
#163 Walnut on Ash	#166 Smoky Umber Ash
#164 Cocoa Ash	#167 Slate Grey Ash

SAVINA LOUNGE/MODULAR

designed by rainlight



SIN #711-16

CORIAN® COLORS:

- Designer White
- Linen
- Rain Cloud
- Witch Hazel

Corian® is a registered trademark of Dupont.

TABLE TOP POWER UNITS:

- PB1, PB2 and PB3 units available on all connecting table tops.
- PB1 and PB2 dimensions: 5³/₄" W x 2¹/₂" D
- PB3 dimensions: 6¹/₂" W x 2¹/₂" D
- Metallic Silver or White finish with white outlets as standard, and 108" electrical cord. Black outlets available upon request.
- UL listed.



PB1

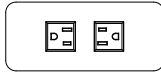

PB2



PB3

- PB1 unit features one outlet and two USB charging ports.
- PB2 unit features two outlets.
- PB3 unit features two outlets and two USB charging ports.
- Standard placement is centered, 5" from the rear.

UNDER-SEAT PLACEMENT POWER UNIT:

- SPB3 unit available on all seating models.
- Dimensions: 6¹/₂" W x 4" D x 2" H.
- Features two white outlets and two USB charging ports inside custom housing unit. Black outlets available upon request.
- Housing unit available in Metallic Silver or White finish with 108" electrical cord.
- UL listed.
- Standard placement locations are as follows:

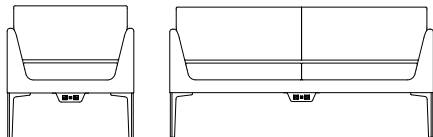
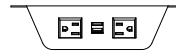

Individual models - center placement as standard

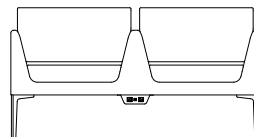

Two-seat model - below center arm placement as standard

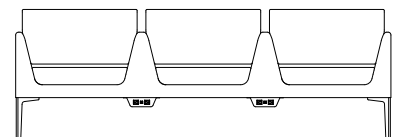

Three-seat model - below shared arms, please specify location (left or right, as facing)

MODULAR ARRANGEMENTS:

- Optional ganging bracket available, please specify "GC06" with quantity and add \$75 List per bracket. One bracket connects two units together.
- Field assembly required.

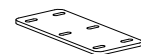

NOTES:

- Legs available in standard and premium metal finishes.
- SPB3 power band available for under-seat placement.
- Custom housing unit available in silver or white.
- Refer to page 5 for two-tone upholstery examples and yardage requirements.

SPECIFY:

1. Model number
2. Base finish
3. Upholstery selection
4. Options, as applicable

ORDERING EXAMPLE:

#5402-PF02-SP3-W

Two-Seat Lounge
Premium Leg Finish
Power Unit, White

SAVINA
LOUNGE/MODULAR

designed by rainlight

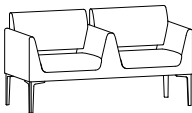
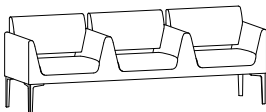
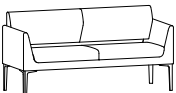

SIN #711-16

MODEL NUMBER	PRODUCT SPECIFICATIONS	FABRIC GRADES								LEATHER GRADES			
		COM	1	2	COL			4	5	6	7	8	L1
5401 	Single Lounge W 28 ¹ / ₂ D 25 H 30 ¹ / ₂ Seat Height 17 ¹ / ₂ Inside Seat Width 22 Inside Seat Depth 19 Arm Height 24 ³ / ₄ 3 Yds. 55 lbs. COL 60 Sq. Ft. TB 133, add \$144 List	1368	1539	1580	1652	1724	1794	1866	1932	2005	2336	2578	2814
5402 	Two-Seat Lounge W 56 D 25 H 30 ¹ / ₂ Seat Height 17 ¹ / ₂ Inside Seat Width 22 Inside Seat Depth 19 Arm Height 24 ³ / ₄ 5 ¹ / ₂ Yds. 94 lbs. COL 110 Sq. Ft. TB 133, add \$264 List	1969	2281	2356	2489	2622	2749	2882	3003	3136	3742	4187	4620
5403 	Three-Seat Lounge W 83 D 25 H 30 ¹ / ₂ Seat Height 17 ¹ / ₂ Inside Seat Width 22 Inside Seat Depth 19 Arm Height 24 ³ / ₄ 7 ¹ / ₂ Yds. 135 lbs. COL 150 Sq. Ft. TB 133, add \$360 List	2783	3209	3311	3492	3673	3847	4028	4193	4374	5201	5807	6398
5404 	Love Seat W 60 D 25 H 30 ¹ / ₂ Seat Height 17 ¹ / ₂ Inside Seat Width 53 ¹ / ₂ Inside Seat Depth 19 Arm Height 24 ³ / ₄ 5 Yds. 80 lbs. COL 100 Sq. Ft. TB 133, add \$240 List	1841	2125	2193	2314	2435	2550	2671	2781	2902	3453	3857	4251

OPTIONS (XXXX - REFERS TO CHAIR MODEL NUMBER)

MODEL	DESCRIPTION	LIST
XXXX-PF02	Premium Finish	80
XXXX-NS12B	Non-Skid Glides	20
UNDER-SEAT PLACEMENT ONLY		
XXXX-SPB3-S	Power Band 3 (dual power, two USB), Silver	569
XXXX-SPB3-W	Power Band 3 (dual power, two USB), White	569
GC06 (ordered separately)	Ganging Connector	75

Q S = Available on Quick-SHIP Program (standard finishes only).

SAVINA LOUNGE/MODULAR

designed by rainlight



NOTES:

- Available in Ash veneer, laminate or Corian.
- Corian top available in seven standard colors.
- Die-cast aluminum leg available in standard and premium metal finishes.
- Mounting hardware included.

SPECIFY:



1. Model number
2. Table finish
3. Leg finish, as applicable
4. Options, as applicable

ORDERING EXAMPLE:

#5415-22-CO-SPB1-W

22" Wide Inline Table,
Corian Top
Power Band 1 Unit, White

SIN #711-16

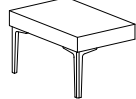
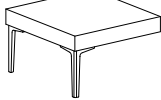
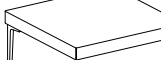
MODEL NUMBER	PRODUCT SPECIFICATIONS	TABLE TOP FINISH	
		VENEER OR LAMINATE	CORIAN (-CO)
5415-15 	15" Wide Inline Table W 15 D 23 20 lbs.	679	1246
5415-22 	22" Wide Inline Table W 22 D 23 22 lbs.	839	1406
5416-15 	15" End Inline Table W 15 D 23 25 lbs.	784	1351
5416-22 	22" End Inline Table W 22 D 23 27 lbs.	944	1511
5417 	Corner Table W 28 D 28 ^{1/2} 45 lbs.	1165	2051

OPTIONS (XXXX - REFERS TO TABLE MODEL NUMBER)

MODEL	DESCRIPTION	LIST
TABLE TOP PLACEMENT		
XXXX-PB1-S	Power Band 1 (one power, two USB), Silver	413
XXXX-PB1-W	Power Band 1 (one power, two USB), White	413
XXXX-PB2-S	Power Band 2 (dual power), Silver	322
XXXX-PB2-W	Power Band 2 (dual power), White	322
XXXX-PB3-S	Power Band 3 (dual power, two USB), Silver	429
XXXX-PB3-W	Power Band 3 (dual power, two USB), White	429
XXXX-PF01	Premium Finish	55
XXXX-NS12A	Non-Skid Glides (per end table)	10
XXXX-NS12C	Non-Skid Glides (per corner table)	5

UPHOLSTERY COMBINATIONS:

For fabric, vinyl or leather upholstery combinations, refer to the pricing below:

- When combining **two** COM/COV/COL fabrics, or fabrics with the same grade, add the following (per unit):
 - › \$65 List for single lounge chair
 - › \$105 List for love seat or two-seat lounge
 - › \$130 List for three-seat lounge
- When combining **three or more** COM/COV/COL fabrics, or fabrics with the same grade, add the following (per unit):
 - › \$75 List for single lounge chair
 - › \$115 List for love seat or two-seat lounge
 - › \$140 List for three-seat lounge
- When combining different grades of fabric, price will be based on the highest grade specified.
- Two-tone upholstery examples and yardage requirements for the most common combinations are listed below. Additional combinations available, please contact Customer Service for yardage requirements and pricing.
- Note: Yardage amounts are based on fabric which is plain (i.e. non-directional) and a full 54" wide.
- **Appropriate upholstery code must be included on order.**

SAVINA LOUNGE/MODULAR

designed by rainlight



SIN #711-16

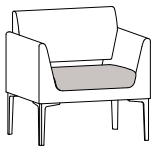

Code SV1
Model COM Requirement
 5401 Seat Cushion Only = 1¹/₄ yds.
 Balance of Chair = 2 yds.

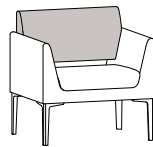

Code SV2
Model COM Requirement
 5401 Back Cushion Only = 1 yd.
 Balance of Chair = 2¹/₄ yds.

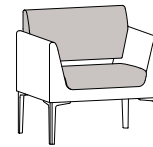

Code SV3
Model COM Requirement
 5401 Seat and Back Cushion = 1¹/₂ yds.
 Balance of Chair = 1¹/₂ yds.

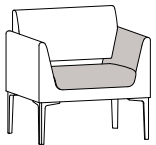

Code SV4
Model COM Requirement
 5401 Seat Cushion & Inside Arm Panels = 1¹/₄ yds.
 Balance of Chair = 1³/₄ yds.

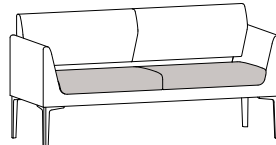

Code SV5
Model COM Requirement
 5404 Seat Cushion Only = 2¹/₄ yds.
 Balance of Love Seat = 3¹/₂ yds.

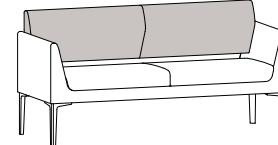

Code SV6
Model COM Requirement
 5404 Back Cushion Only = 2 yds.
 Balance of Love Seat = 3¹/₄ yds.

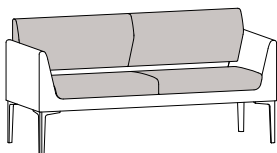

Code SV7
Model COM Requirement
 5404 Seat and Back Cushion = 4 yds.
 Balance of Love Seat = 2 yds.

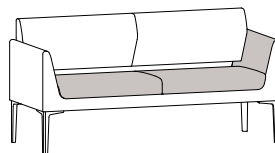

Code SV8
Model COM Requirement
 5404 Seat Cushion & Inside Arm Panels = 2¹/₄ yds.
 Balance of Love Seat = 3¹/₂ yds.

SAVINA LOUNGE/MODULAR

designed by rainlight



SIN #711-16

UPHOLSTERY COMBINATIONS:

For fabric, vinyl or leather upholstery combinations, refer to the pricing below:

- When combining **two** COM/COV/COL fabrics, or fabrics with the same grade, add the following (per unit):
 - › \$65 List for single lounge chair
 - › \$105 List for love seat or two-seat lounge
 - › \$130 List for three-seat lounge
- When combining **three or more** COM/COV/COL fabrics, or fabrics with the same grade, add the following (per unit):
 - › \$75 List for single lounge chair
 - › \$115 List for love seat or two-seat lounge
 - › \$140 List for three-seat lounge
- When combining different grades of fabric, price will be based on the highest grade specified.
- Two-tone upholstery examples and yardage requirements for the most common combinations are listed below. Additional combinations available, please contact Customer Service for yardage requirements and pricing.
- Note: Yardage amounts are based on fabric which is plain (i.e. non-directional) and a full 54" wide.
- **Appropriate upholstery code must be included on order.**

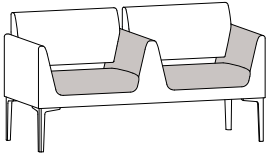

Code SV10
Model 5402 COM Requirement
 Seat Cushion & Inside Arm Panels = 2³/₄ yds.
 Balance of Unit = 3 yds.

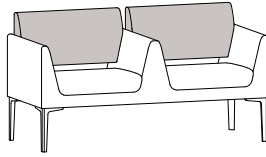

Code SV11
Model 5402 COM Requirement
 Back Cushions = 1³/₄ yds.
 Balance of Unit = 4 yds.

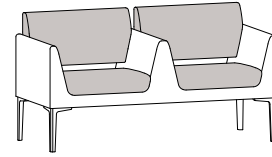

Code SV12
Model 5402 COM Requirement
 Seat & Back Cushions = 2¹/₂ yds.
 Balance of Unit = 3 yds.

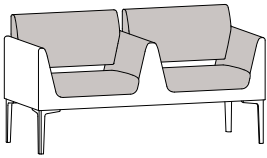

Code SV13
Model 5402 COM Requirement
 Seat Cushions, Back Cushions & Inside Arm Panels = 3³/₄ yds.
 Balance of Unit = 1³/₄ yds.

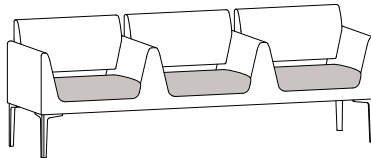

Code SV14
Model 5403 COM Requirement
 Seat Cushions = 2¹/₂ yds.
 Balance of Unit = 5 yds.

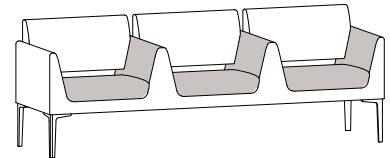

Code SV15
Model 5403 COM Requirement
 Seat Cushion & Inside Arm Panels = 4 yds.
 Balance of Unit = 4 yds.

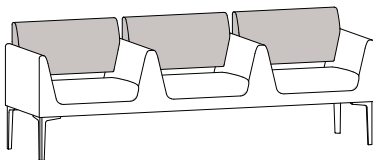

Code SV16
Model 5403 COM Requirement
 Back Cushions = 2 yds.
 Balance of Unit = 5¹/₂ yds.

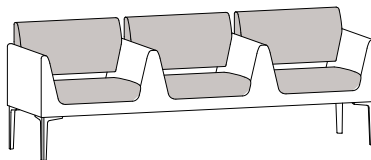

Code SV17
Model 5403 COM Requirement
 Seat & Back Cushions = 4¹/₄ yds.
 Balance of Unit = 3¹/₂ yds.

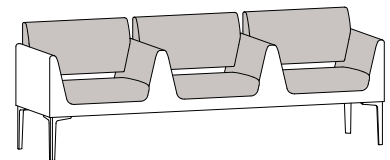

Code SV18
Model 5403 COM Requirement
 Seat Cushions, Back Cushions & Inside Arm Panels = 5¹/₂ yds.
 Balance of Unit = 2¹/₄ yds.



SAVINA

OCCASIONAL TABLES

designed by rainlight



SIN #711-11

PRODUCT FEATURES:

- Round and racetrack shapes with floating top design detail.
- Tops are 1" thick and offered in Ash veneer as well as laminate, Corian® and Starphire® low iron back-painted glass.
- All standard and custom wood finishes available.
- For custom wood finishes, please add \$400 List per color per order.
- For veneer tops, edge finish will always match top finish color, unless otherwise specified.
- For standard laminates, refer to Standard Finish Card. Laminate top features laminate self edge.
- For custom laminates, add \$500 List per color per order. Pre-approval required, please contact Customer Service.
- Corian top available in four standard colors.
- Glass is back-painted white as standard and may be used as a writable surface with dry-erase markers.
- For non-standard Corian or back-painted glass colors, please contact Customer Service for pricing.
- 1/2" diameter metal rod base available in standard and premium finishes.
- Non-skid glides available for hard surface floors.
- All dimensions are nominal.

ASH WOOD FINISHES:

#162 White Oak on Ash	#165 Kona Ash
#163 Walnut on Ash	#166 Smoky Umber Ash
#164 Cocoa Ash	#167 Slate Grey Ash

STANDARD METAL FINISH COLORS:

#06 Charcoal Grey
 #90 Metallic Silver
 #92 Polished Aluminum
 #95 Satin Black

PREMIUM METAL FINISH COLORS:

#07 Gold Shimmer #83 Metallic Champagne
 #08 Penny #94 Cotton
 #09 Brown Sugar

CORIAN® COLORS:

Designer White
 Linen
 Rain Cloud
 Witch Hazel

Corian® is a registered trademark of Dupont.

SAVINA OCCASIONAL TABLES

designed by rainlight



NOTES:

- Available in Ash veneer, as well as laminate, Corian and white back-painted glass.
- Metal base available in standard and premium finishes.

SPECIFY:

1. Model number
2. Top finish
3. Base finish
4. Options, as applicable

ORDERING EXAMPLE:

#5475-PG-PF03-NS01
Racetrack-Shaped Table
Back-Painted Glass Top
Premium Base Finish
Non-Skid Glides

SIN #711-11

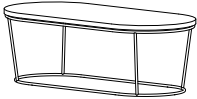
		MODEL NUMBER	VENEER OR LAMINATE	CORIAN (-CO)	BACK-PAINTED GLASS (-PG)	WEIGHT <small>(Veneer/Laminate Top)</small>
5470  Q S Round Top 22" Dia. x 19" H 36" Dia. x 16" H		5470-2219	1046	1523	1425	19
		5470-3616	1924	3200	2400	35
5475  Q S Racetrack Top 48" L x 22" W x 16" H		5475-482216	1737	2777	2215	49

OPTIONS (XXXX - REFERS TO TABLE MODEL NUMBER)

MODEL	DESCRIPTION	LIST
XXXX-NS01	Non-Skid Glides	20
XXXX-PF03	Premium Base Finish	110

Q S = Available on Quick-Ship Program, all sizes and surface materials (standard finishes only).

NOTES:

- Manufactured in Beech.
- Three fixed leg finishes: #90 Metallic Silver, #91 Chrome and #95 Satin Black.
- Beech wood fixed legs also available, refer to options for pricing and appropriate code.
- All standard and custom wood finishes available on wood legs.
- For custom wood finishes, please add one-time upcharge of \$400 List per color per order.
- Two-tone upholstery examples and yardage requirements featured on page 2.

SPECIFY:

1. Model number
2. Leg finish
3. Upholstery selection
4. Options, as applicable

ORDERING EXAMPLE:

#7466-NS06B

66" Bench
Non-Skid Glides

SERAFINA BENCHES

designed by david dahl

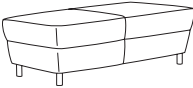
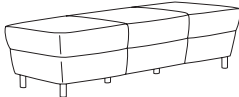

SIN #711-16

MODEL NUMBER	PRODUCT SPECIFICATIONS	FABRIC GRADES								LEATHER GRADES			
		COM	1	2	COL			7	8	L1	L2	L3	
7444 	44" L x 22" D x 18" H 2 ³ / ₄ Yds. 64 lbs. COL 55 Sq. Ft. TB 133, add \$132 List	1485	1641	1679	1745	1812	1875	1942	2002	2069	2372	2594	2811
		1980	2207	2262	2358	2455	2547	2644	2732	2829	3270	3593	3908
7466 	66" L x 22" D x 18" H 4 Yds. 100 lbs. COL 80 Sq. Ft. TB 133, add \$192 List												

OPTIONS (XXXX - REFERS TO BENCH MODEL NUMBER)

MODEL	DESCRIPTION	LIST	WEIGHT CAPACITY:
XXXX-NS06B	Non-Skid Glides	20	#7444 700 lbs.
XXXX-WL01	Beech Wood Legs	110	#7466 1050 lbs.

SERAFINA BENCHES

designed by david dahl



UPHOLSTERY COMBINATIONS:

For fabric, vinyl or leather upholstery combinations, refer to the pricing below:

- When combining **two** COM/COV/COL fabrics, or fabrics with the same grade, price will be \$65 List (per unit).
 - When combining **three or more** COM/COV/COL fabrics, or fabrics with the same grade, price will be \$75 List (per unit).
 - When combining different grades of fabric, price will be based on the highest grade specified.
- Two-tone upholstery examples and yardage requirements for the most common combinations are listed below. Additional combinations available, please contact Customer Service for yardage requirements and pricing.
 - Note: Yardage amounts are based on fabric which is plain (i.e. non-directional) and a full 54" wide.
 - **Appropriate upholstery code must be included on order.**

SIN #711-16



Code SB2

Model COM Requirement
 7444 Seat Cushion = 1³/₄ yds.
 Seat Box = 1¹/₄ yds.

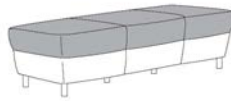

Code SB3

Model COM Requirement
 7466 Seat Cushion = 2³/₄ yds.
 Seat Box = 1¹/₂ yds.

SERAFINA LOUNGE

designed by david dahl



SIN #711-16

PRODUCT FEATURES:

- Fixed seat cushion.
- Four fixed leg finishes: #90 Metallic Silver, #91 Chrome, #95 Satin Black and Beech wood.
- For wood fixed legs, please specify “-WL01” after model number with finish selection and add \$110 List per unit.
- All standard and custom wood finishes available on Beech.
- For custom wood finishes, please add one-time upcharge of \$400 List per color per order.
- Non-skid glides available for hard surface floors. Please specify “-NS06B” after model number and add \$20 List per unit.
- Optional casters available, please specify “-C01” after model number and add \$50 List.
- Mobile version comes standard with two locking casters in rear and two non-locking casters in front.
- Caster color is silver as standard.
- Black casters available, please specify.
- Soft-tread casters available, black color only. Please specify “-C05” and add \$50 List per set (includes 4 casters).
- Maximum weight capacity is 350 lbs. for lounge chairs, 700 lbs. for love seats and 1000 lbs. for sofas.
- Please refer to page 4 for two-tone upholstery examples, yardage requirements and pricing.
- All dimensions are nominal.

ROTATING TABLET:

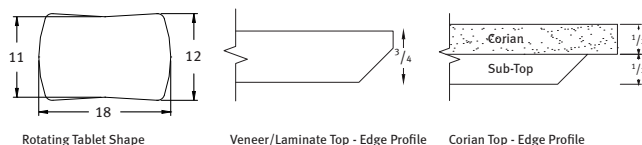

- Rotating tablet size is 18" W x 12" D x $\frac{3}{4}$ " thick with 360-degree turning radius.
- Tablet affixed to right or left arm/side as specified.
- Three surface options: veneer, laminate or Corian.
- Veneer offered in Beech, Walnut and White Oak, in all standard and custom wood finishes.
- For custom wood finishes (to legs, tablets and/or table-ettes), please add one-time upcharge of \$400 List per color per order.
- Laminate and Corian is applied to top surface only.
- For standard laminates, refer to Standard Finish Card.
- For custom laminates, add \$500 List per color per order. Pre-approval required, please contact Customer Service.
- Corian available in four standard colors each. For non-standard options, please contact Customer Service for pricing.
- For maximum durability, a laminate or Corian surface with a clear coat edge finish is recommended.
- Tablet mounting post available in three finishes: #90 Metallic Silver, #91 Chrome and #95 Satin Black.

CORIAN® COLORS:

Designer White
Linen
Rain Cloud
Witch Hazel

Corian® is a registered trademark of Dupont.

SERAFINA LOUNGE

designed by david dahl



SIN #711-16

TABLET EDGE FINISH SPECIFICATIONS:

- For veneer tops, edge finish will always match the top finish color, unless otherwise specified.
- For standard laminate tops (laminate cannot be applied to the edge):
 - › Wood grain laminates, edge finish will match the laminate top color, unless otherwise specified.
 - › Solid color laminates, edge finish will be natural (clear coat) as standard, unless otherwise specified.
- For Corian tops:
 - › Designer White, Rain Cloud and Linen colors, edge will be white as standard, unless otherwise specified.
 - › Witch Hazel, edge will be natural (clear coat) as standard, unless otherwise specified.
- Edges are also available in all standard wood finishes, please specify. For custom edge finishes, please add one-time upcharge of \$400 List per color, per order.

POWER UNITS:

- Unit affixed to right side, as seated, unless otherwise specified.
- PB1 and PB2 dimensions: 5³/₄" W x 2¹/₂" D
- PB3 dimensions: 6¹/₂" W x 2¹/₂" D
- Metallic Silver or White finish with 108" electrical cord.
- UL listed.
- **Not available on units with casters.**

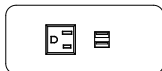

PB1

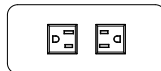

PB2

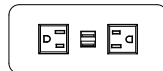

PB3

- PB1 unit features one outlet and two USB charging ports.
- PB2 unit features two outlets.
- PB3 unit features two outlets and two USB charging ports.

NOTES:

- Four fixed leg finishes: #90 Metallic Silver, #91 Chrome, #95 Satin Black and Beech wood.
- For wood fixed legs, add \$110 List and specify finish.
- **Power units not available on models with casters.**
- Refer to page 4 for two-tone upholstery examples and yardage requirements.

SPECIFY:

1. Model number
2. Leg finish
3. Upholstery selection
4. Options, as applicable

ORDERING EXAMPLE:

#4541-TAR14-CO-PB1



Lounge Chair
Corian Tablet, Right
Power Band 1 Unit

SERAFINA LOUNGE

designed by david dahl

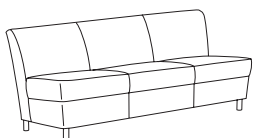

SIN #711-16

MODEL NUMBER	PRODUCT SPECIFICATIONS	FABRIC GRADES								LEATHER GRADES			
		COM	1	2	COL			6	7	8	L1	L2	L3
4541 	Lounge Chair with Fixed Legs W 25 ¹ / ₂ D 31 H 32 Seat Height 18 Seat Width 25 ¹ / ₂ Seat Depth 20 ¹ / ₂ 3 Yds. 42 lbs. COL 60 Sq. Ft. TB 133, add \$144 List	1166	1337	1378	1450	1522	1592	1664	1730	1803	2134	2376	2612
4542 	Love Seat with Fixed Legs W 50 D 31 H 32 Seat Height 18 Seat Width 50 Seat Depth 20 ¹ / ₂ 5 Yds. 80 lbs. COL 100 Sq. Ft. TB 133, add \$240 List	1763	2047	2115	2236	2357	2472	2593	2703	2824	3375	3779	4173
4543 	Sofa with Fixed Legs W 72 D 31 H 32 Seat Height 18 Seat Width 72 Seat Depth 20 ¹ / ₂ 7 Yds. 122 lbs. COL 140 Sq. Ft. TB 133, add \$336 List	2392	2789	2885	3054	3223	3385	3554	3708	3877	4649	5215	5766

OPTIONS (XXXX - REFERS TO CHAIR MODEL NUMBER)

MODEL	DESCRIPTION	LIST
XXXX-TAR14	Veneer/Laminate Rotating Tablet, Right (as seated)	428
XXXX-TAL14	Veneer/Laminate Rotating Tablet, Left (as seated)	428
XXXX-TAR14-CO	Corian Rotating Tablet, Right (as seated)	731
XXXX-TAL14-CO	Corian Tablet, Left (as seated)	731
XXXX-PB1-S	Power Band 1 (one power, two USB), Silver	413
XXXX-PB1-W	Power Band 1 (one power, two USB), White	413
XXXX-PB2-S	Power Band 2 (dual power), Silver	322
XXXX-PB2-W	Power Band 2 (dual power), White	322
XXXX-PB3-S	Power Band 3 (dual power, two USB), Silver	429
XXXX-PB3-W	Power Band 3 (dual power, two USB), White	429
XXXX-WL01	Wood Legs	110
XXXX-NS06B	Non-Skid Glides	20
XXXX-C01	Casters (set of 4), Silver or Black, please specify	50
XXXX-C05	Soft Tread Casters (set of 4)	50

SERAFINA LOUNGE

designed by david dahl



UPHOLSTERY COMBINATIONS:

For fabric, vinyl or leather upholstery combinations, refer to the pricing below:

- When combining **two** COM/COV/COL fabrics, or fabrics with the same grade, add the following (per unit):
 - › \$65 List for lounge chairs
 - › \$105 List for love seats
 - › \$130 List for sofas
- When combining **three or more** COM/COV/COL fabrics, or fabrics with the same grade, add the following (per unit):
 - › \$75 List for lounge chairs
 - › \$115 List for love seats
 - › \$140 List for sofas

- When combining different grades of fabric, price will be based on the highest grade specified.
- Two-tone upholstery examples and yardage requirements for the most common combinations are listed below. Additional combinations available, please contact Customer Service for yardage requirements and pricing.
- Note: Yardage amounts are based on fabric which is plain (i.e. non-directional) and a full 54" wide.
- **Appropriate upholstery code must be included on order.**

SIN #711-16



Code SE1
Model COM Requirement
 4541 Seat Cushion Only = 1 yd.
 Balance of Chair = 2¹/₂ yds.

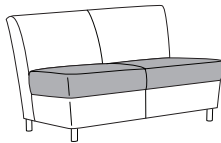

Code SE2
Model COM Requirement
 4542 Seat Cushion Only = 2 yds.
 Balance of Love Seat = 3¹/₂ yds.

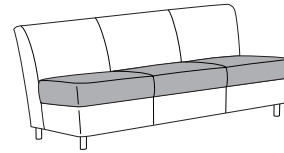

Code SE3
Model COM Requirement
 4543 Seat Cushion Only = 3 yds.
 Balance of Sofa = 4¹/₂ yds.

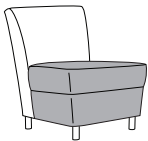

Code SE5
Model COM Requirement
 4541 Inside/Outside Back = 2 yds.
 Seat Cushion/Seat Box = 1¹/₂ yds.

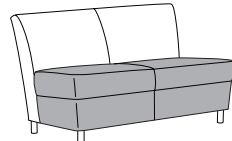

Code SE6
Model COM Requirement
 4542 Inside/Outside Back = 2³/₄ yds.
 Seat Cushion/Seat Box = 2¹/₂ yds.

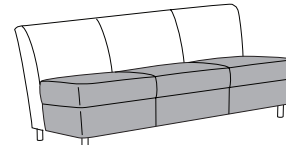

Code SE7
Model COM Requirement
 4543 Inside/Outside Back = 3³/₄ yds.
 Seat Cushion/Seat Box = 3¹/₂ yds.



Code SE8
Model COM Requirement
 4541 Inside Back/Seat Cushion = 1¹/₂ yds.
 Balance of Chair = 2 yds.

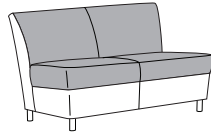

Code SE9
Model COM Requirement
 4542 Inside Back/Seat Cushion = 2³/₄ yds.
 Balance of Love Seat = 2³/₄ yds.

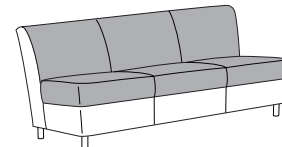

Code SE10
Model COM Requirement
 4543 Inside Back/Seat Cushion = 4 yds.
 Balance of Sofa = 3¹/₂ yds.

SERAFINA MODULAR

designed by david dahl



SIN #711-16

LOUNGE PRODUCT FEATURES:

- Single, 2-seat and 3-seat armless units.
- Fixed seat cushion.
- Four fixed leg finishes: #90 Metallic Silver, #91 Chrome, #95 Satin Black and Beech wood.
- For wood fixed legs, please specify “-WL01” after model number with finish selection and add \$110 List per unit.
- All standard and custom wood finishes available on Beech.
- For custom wood finishes (to legs, connecting bridges, tablets and/or table-ettes), please add one-time upcharge of \$400 List per color per order.
- Non-skid glides available for hard surface floors. Please specify “-NS06B” after model number and add \$20 List per unit.
- Each unit comes standard with 4 concealed linking connectors.
- Linking connectors pivot outward from underneath chair to link with bridges.
- Tablets available on individual chair units, seat end-units and specified connecting bridges.
- Maximum weight capacity is 350 lbs. for lounge chairs, 700 lbs. for love seats and 1000 lbs. for sofas.
- Please refer to page 10 for two-tone upholstery examples, yardage requirements and pricing.
- All dimensions are nominal.

CONNECTING BRIDGES:

- Available in six sizes: 6" wide straight, 20" wide straight, 30-degree, 45-degree, 60-degree and 90-degree.
- Bridges available in veneer, laminate, upholstered, or in combination.
- Upholstered bridges feature wood top as standard.
- All standard and custom wood finishes available on Beech.
- For custom wood finishes (to legs, connecting bridges, tablets and/or table-ettes), please add one-time upcharge of \$400 List per color per order.
- Corian top is 1/2" thick in lieu of standard table top thickness of 3/4".
- Corian top available in four standard colors. For non-standard colors, please contact Customer Service for pricing.
- Laminate and Corian tops feature veneer body as standard, please specify wood species and finish.
- For laminate top and body, or Corian top with laminate body, please specify and contact Customer Service for pricing.
- Fixed legs support bridges and allow them to stand alone.
- Four fixed leg finishes: #90 Metallic Silver, #91 Chrome, #95 Satin Black and Beech wood.
- Non-skid glides available for hard surface floors. Please specify “-NS062B” after model number and add \$20 List per unit.
- Each unit comes standard with 4 fixed linking receivers.
- All connecting bridges are interchangeable and reversible.
- When reversing connecting bridges, angles will vary by 11-degrees (e.g. 30-degree bridge when reversed becomes a 41-degree angle).
- Optional accessories sold separately.
- All dimensions are nominal.

CORIAN® COLORS:

Designer White
Linen
Rain Cloud
Witch Hazel

Corian® is a registered trademark of Dupont.

SERAFINA MODULAR

designed by david dahl



SIN #711-16

ROTATING TABLET:

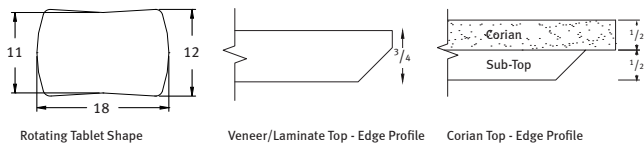

- Available on all individual chair units, seat end-units and specified connecting bridges.
- Tablet size is 18" W x 12" D x $\frac{3}{4}$ " thick with 360-degree tablet turning radius.
- Three surface options: Beech veneer, laminate or Corian.
- All standard and custom wood finishes available on Beech.
- For custom wood finishes (to legs, connecting bridges, tablets and/or table-ettes), please add one-time upcharge of \$400 List per color per order.
- Laminate and Corian is applied to top surface only.
- For standard laminates, refer to Standard Finish Card.
- For custom laminates, add \$500 List per color per order. Pre-approval required, please contact Customer Service.
- Corian available in four standard colors each. For non-standard options, please contact Customer Service for pricing.
- For maximum durability, a laminate or Corian surface with a clear coat edge finish is recommended.
- Tablet mounting post available in three finishes: #90 Metallic Silver, #91 Chrome and #95 Satin Black.

TABLET EDGE FINISH SPECIFICATIONS:

- For veneer tops, edge finish will always match the top finish color, unless otherwise specified.
- For standard laminate tops (laminate cannot be applied to the edge):
 - › Wood grain laminates, edge finish will match the laminate top color, unless otherwise specified.
 - › Solid color laminates, edge finish will be natural (clear coat) as standard, unless otherwise specified.
- For Corian tops:
 - › Designer White, Rain Cloud and Linen colors, edge will be white as standard, unless otherwise specified.
 - › Witch Hazel, edge will be natural (clear coat) as standard, unless otherwise specified.
- Edges are also available in all standard wood finishes, please specify. For custom edge finishes, please add one-time upcharge of \$400 List per color, per order.

SERAFINA MODULAR

designed by david dahl



SIN #711-16

POWER UNITS:

- Available on individual chair units, seat end-units and specified connecting bridges.
- When specified on connecting bridges, power unit will be mounted at the wide end of the bridge as standard. For placement elsewhere, please specify and contact Customer Service for verification.
- PB1 and PB2 dimensions: 5³/₄" W x 2¹/₂" D
- PB3 dimensions: 6¹/₂" W x 2¹/₂" D
- Metallic Silver or White finish with 108" electrical cord.
- UL listed.

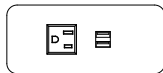

PB1

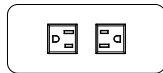

PB2

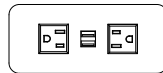

PB3

- PB1 unit features one outlet and two USB charging ports.
- PB2 unit features two outlets.
- PB3 unit features two outlets and two USB charging ports.

SERAFINA MODULAR

designed by david dahl



NOTES:

- Legs available in #90 Metallic Silver, #91 Chrome, #95 Satin Black and Beech wood.
- For wood fixed legs, add \$110 List and specify finish.
- Each unit comes standard with 4 concealed linking connectors.
- Side-mount metal post for tablets available in #90 Metallic Silver, #91 Chrome and #95 Satin Black.
- Refer to page 10 for two-tone upholstery examples and yardage requirements.

SPECIFY:

1. Model number
2. Leg finish
3. Upholstery selection
4. Options, as applicable

ORDERING EXAMPLE:

#4541-TAR14-PB3-S

Lounge Chair
Veneer Tablet, Right
Power Band 3 Unit, Silver

SIN #711-16

MODEL NUMBER	PRODUCT SPECIFICATIONS	FABRIC GRADES							LEATHER GRADES				
		COM	1	2	COL			8	L1	L2	L3		
4541-G	Lounge Chair with Fixed Legs W 26 D 31½ H 32 Seat Height 18 Seat Width 26 Seat Depth 20½ 3 Yds. 42 lbs. COL 60 Sq. Ft. TB 133, add \$144 List	1288	1459	1500	1572	1644	1714	1786	1852	1925	2256	2498	2734
4542-G	Love Seat with Fixed Legs W 50 D 31½ H 32 Seat Height 18 Seat Width 50 Seat Depth 20½ 5 Yds. 80 lbs. COL 100 Sq. Ft. TB 133, add \$240 List	1887	2171	2239	2360	2481	2596	2717	2827	2948	3499	3903	4297
4543-G	Sofa with Fixed Legs W 72 D 31½ H 32 Seat Height 18 Seat Width 72 Seat Depth 20½ 7 Yds. 122 lbs. COL 140 Sq. Ft. TB 133, add \$336 List	2514	2911	3007	3176	3345	3507	3676	3830	3999	4771	5337	5888

OPTIONS (XXXX - REFERS TO CHAIR MODEL NUMBER)

MODEL	DESCRIPTION	LIST
XXXX-TAR14	Veneer/Laminate Rotating Tablet, Right (as seated)	428
XXXX-TAL14	Veneer/Laminate Rotating Tablet, Left (as seated)	428
XXXX-TAR14-CO	Corian Rotating Tablet, Right (as seated)	731
XXXX-TAL14-CO	Corian Tablet, Left (as seated)	731
XXXX-PB1-S	Power Band 1 (one power, two USB), Silver	413
XXXX-PB1-W	Power Band 1 (one power, two USB), White	413
XXXX-PB2-S	Power Band 2 (dual power), Silver	322
XXXX-PB2-W	Power Band 2 (dual power), White	322
XXXX-PB3-S	Power Band 3 (dual power, two USB), Silver	429
XXXX-PB3-W	Power Band 3 (dual power, two USB), White	429
XXXX-WL01	Wood Legs	110
XXXX-NS06B	Non-Skid Glides	20

NOTES:

- Bridges standard with Beech veneer. Laminate and Corian tops available, please specify.
- Four fixed leg finishes: #90 Metallic Silver, #91 Chrome, #95 Satin Black and Beech wood.
- For wood fixed legs, add \$110 List and specify finish.
- Each unit comes standard with 4 fixed linking receivers.
- All connecting bridges are inter-changeable and reversible.
- When reversing connecting bridges, angles will vary by 11-degrees (e.g. 30-degree bridge when reversed becomes a 41-degree angle).

SPECIFY:

1. Model number
2. Wood finish
3. Leg finish

Note: 90-degree bridges can only accommodate one tablet or table-ette.

ORDERING EXAMPLE:

#4530-W-CO-PB1-W

30-Degree Bridge
Corian Top
Power Band 1 Unit, White

SERAFINA MODULAR

designed by david dahl

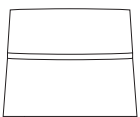
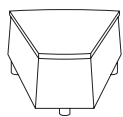
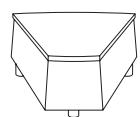
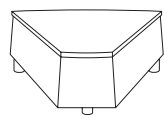
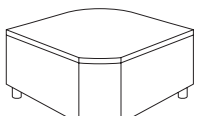

SIN #711-16

MODEL NUMBER	PRODUCT SPECIFICATIONS	TABLE TOP FINISH	
		VENEER OR LAMINATE	CORIAN (-CO)
4506-W 	6" Straight Connecting Bridge Closed (Front & Back) W 6 D 20 ¹ / ₄ H 16 23 lbs.	835	1107
4520-W 	20" Straight Connecting Bridge Closed (Front & Back) W 20 D 20 ¹ / ₂ H 16 45 lbs.	884	1393
4530-W 	30-Degree Connecting Bridge Closed (Front & Back) W 10 D 19 ¹ / ₄ H 16 34 lbs.	884	1575
4545-W 	45-Degree Connecting Bridge Closed (Front & Back) W 10 D 18 ³ / ₄ H 16 38 lbs.	908	1535
4560-W 	60-Degree Connecting Bridge Closed (Front & Back) W 10 D 17 H 16 40 lbs.	977	1724
4590-W 	90-Degree Connecting Bridge Closed (Front & Back) W 6 ³ / ₄ D 28 ¹ / ₂ H 16 58 lbs.	1433	2781

OPTIONS (XXXX - REFERS TO TABLE MODEL NUMBER)

MODEL	DESCRIPTION	LIST
XXXX-PB1-S	Power Band 1 (one power, two USB), Silver	413
XXXX-PB1-W	Power Band 1 (one power, two USB), White	413
XXXX-PB2-S	Power Band 2 (dual power), Silver	322
XXXX-PB2-W	Power Band 2 (dual power), White	322
XXXX-PB3-S	Power Band 3 (dual power, two USB), Silver	429
XXXX-PB3-W	Power Band 3 (dual power, two USB), White	429
XXXX-WL01	Wood Legs	110
XXXX-NS06B	Non-Skid Glides	20

SERAFINA MODULAR

designed by david dahl



SIN #711-16

NOTES:

- Upholstered bridges feature Beech veneer top as standard. Laminate and Corian tops available, please specify.
- Four fixed leg finishes: #90 Metallic Silver, #91 Chrome, #95 Satin Black and Beech wood.
- For wood fixed legs, add \$110 List and specify finish.
- Each unit comes standard with 4 fixed linking receivers.
- All connecting bridges are inter-changeable and reversible.
- When reversing connecting bridges, angles will vary by 11-degrees (e.g. 30-degree bridge when reversed becomes a 41-degree angle).

SPECIFY:

1. Model number
2. Wood finish
3. Leg finish
4. Upholstery selection
5. Options, as applicable

ORDERING EXAMPLE:

#4506-U-PB1-S

6" Upholstered Bridge
Power Band 1 Unit, Silver

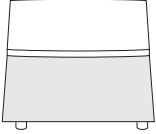
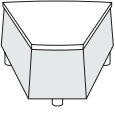
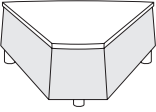
MODEL NUMBER	PRODUCT SPECIFICATIONS	FABRIC GRADES							LEATHER GRADES				
		COM	1	2	COL			8	L1	L2	L3		
4506-U 	Upholstered Connecting Bridge 6" Straight, Wood Top Closed (Front & Back) W 6 D 20 ¹ / ₄ H 16 1 Yd. 22 lbs. COL 20 Sq. Ft. TB 133, add \$48 List	834	891	905	929	953	976	1000	1022	1047	1157	1238	1316
4520-U 	Upholstered Connecting Bridge 20" Straight, Wood Top Closed (Front & Back) W 20 D 20 ¹ / ₂ H 16 1 Yd. 47 lbs. COL 20 Sq. Ft. TB 133, add \$48 List	882	939	953	977	1001	1024	1048	1070	1095	1205	1286	1364
4530-U 	Upholstered Connecting Bridge 30-Degree, Wood Top Closed (Front & Back) W 10 D 19 ¹ / ₄ H 16 1 Yd. 36 lbs. COL 20 Sq. Ft. TB 133, add \$48 List	882	939	953	977	1001	1024	1048	1070	1095	1205	1286	1364
4545-U 	Upholstered Connecting Bridge 45-Degree, Wood Top Closed (Front & Back) W 10 D 18 ³ / ₄ H 16 1 Yd. 40 lbs. COL 20 Sq. Ft. TB 133, add \$48 List	908	965	979	1003	1027	1050	1074	1096	1121	1231	1312	1390

Corian Top Upcharge:
 4506-U add \$236 List
 4520-U add \$447 List
 4530-U add \$609 List
 4545-U add \$550 List

OPTIONS (XXXX - REFERS TO TABLE MODEL NUMBER)

MODEL	DESCRIPTION	LIST
XXXX-PB1-S	Power Band 1 (one power, two USB), Silver	413
XXXX-PB1-W	Power Band 1 (one power, two USB), White	413
XXXX-PB2-S	Power Band 2 (dual power), Silver	322
XXXX-PB2-W	Power Band 2 (dual power), White	322
XXXX-PB3-S	Power Band 3 (dual power, two USB), Silver	429
XXXX-PB3-W	Power Band 3 (dual power, two USB), White	429
XXXX-WL01	Wood Legs	110
XXXX-NS06B	Non-Skid Glides	20

NOTES:

- Upholstered bridges feature Beech veneer top as standard. Laminate and Corian tops available, please specify.
- Four fixed leg finishes: #90 Metallic Silver, #91 Chrome, #95 Satin Black and Beech wood.
- For wood fixed legs, add \$110 List and specify finish.
- Each unit comes standard with 4 fixed linking receivers.
- All connecting bridges are inter-changeable and reversible.
- When reversing connecting bridges, angles will vary by 11-degrees (e.g. 30-degree bridge when reversed becomes a 41-degree angle).

SPECIFY:

1. Model number
2. Wood finish
3. Leg finish
4. Upholstery selection
5. Options, as applicable

Note: 90-degree bridges can only accommodate one tablet.

ORDERING EXAMPLE:

#4560-U-NS06B

60-Degree Upholstered Bridge
Non-Skid Glides

SERAFINA MODULAR

designed by david dahl

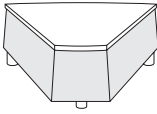
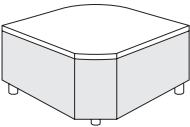

SIN #711-16

MODEL NUMBER	PRODUCT SPECIFICATIONS	FABRIC GRADES							LEATHER GRADES				
		COM	1	2	COL 3	4	5	6	7	8	L1	L2	L3
4560-U	 <p>Upholstered Connecting Bridge 60-Degree, Wood Top Closed (Front & Back) W 10 D 17 H 16 1 Yd. 42 lbs. COL 20 Sq. Ft. TB 133, add \$48 List</p>	977	1034	1048	1072	1096	1119	1143	1165	1190	1300	1381	1459
4590-U	 <p>Upholstered Connecting Bridge 90-Degree, Wood Top Closed (Front & Back) W 6³/₄ D 28¹/₂ H 16 1¹/₄ Yds. 60 lbs. COL 25 Sq. Ft. TB 133, add \$60 List</p>	1434	1505	1522	1553	1583	1612	1642	1669	1700	1837	1938	2037

Corian Top Upcharge:
4560-U add \$656 List
4590-U add \$1188 List

OPTIONS (XXXX - REFERS TO TABLE MODEL NUMBER)

MODEL	DESCRIPTION	LIST
XXXX-PB1-S	Power Band 1 (one power, two USB), Silver	413
XXXX-PB1-W	Power Band 1 (one power, two USB), White	413
XXXX-PB2-S	Power Band 2 (dual power), Silver	322
XXXX-PB2-W	Power Band 2 (dual power), White	322
XXXX-PB3-S	Power Band 3 (dual power, two USB), Silver	429
XXXX-PB3-W	Power Band 3 (dual power, two USB), White	429
XXXX-WL01	Wood Legs	110
XXXX-NS06B	Non-Skid Glides	20

SERAFINA MODULAR

designed by david dahl



SIN #711-16

NOTES:

- Tablet size is 18" W x 12" D x 3/4" thick.
- 360-degree tablet turning radius.
- Tablet height from floor: 26 1/4"
- Three surface options: Beech veneer, laminate and Corian.
- Tablet mounted to connecting bridge surface with metal post.
- Metal post available in three finishes: #90 Metallic Silver, #91 Chrome and #95 Satin Black.
- **List accessory model number after appropriate connecting bridge model number**

SPECIFY:

1. Model number
2. Tablet finish
3. Post finish
4. Options, as applicable

Please include seating layout drawings or sketch with each order.

ORDERING EXAMPLE:

#4530-W-TAC04

30-Degree Veneer Bridge Rotating Tablet, Center

MODEL NUMBER	PRODUCT SPECIFICATIONS	TABLET TOP FINISH	
		VENEER OR LAMINATE	CORIAN (-CO)
<p>XXXX-TAC04</p>	<p>Bridge Rotating Tablet - Center Inside Wedge 9 lbs.</p>	366	668
<p>XXXX-TAL15</p>	<p>Bridge Rotating Tablet - Left (as seated) Outside Wedge 9 lbs.</p>	366	668
<p>XXXX-TAR15</p>	<p>Bridge Rotating Tablet - Right (as seated) Outside Wedge 9 lbs.</p>	366	668

SERAFINA MODULAR

designed by david dahl



SIN #711-16

CONFIGURATION EXAMPLES

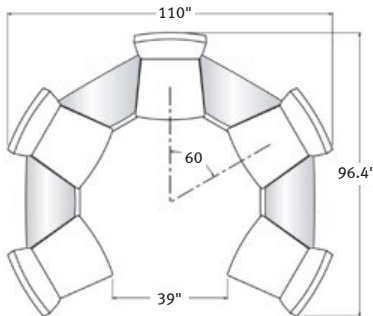

Qty	Model #	Description	COM List
5	4541-G	Lounge Chair, Armless (\$1,288 each)	6,440
4	4560-W	60-Degree Veneer Bridge (\$977 each)	3,908
9			10,348

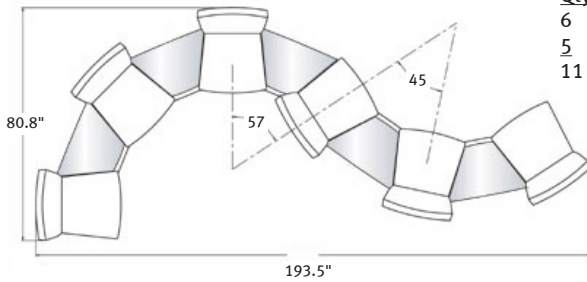

Qty	Model #	Description	COM List
6	4541-G	Lounge Chair, Armless (\$1,288 each)	7,728
5	4545-U	45-Degree Upholstered Bridge (\$908 each)	4,540
11			12,268

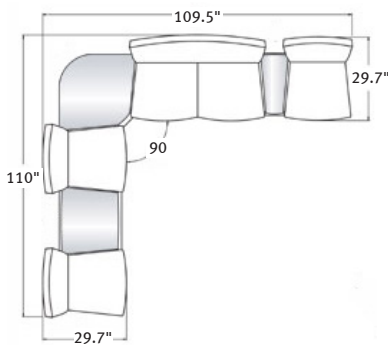

Qty	Model #	Description	COM List
3	4541-G	Lounge Chair, Armless (\$1,288 each)	3,864
1	4542-G	Love Seat, Armless	1,887
1	4520-W	20" Straight Veneer Bridge	884
1	4590-W	90-Degree Veneer Bridge	1,433
1	4506-W	6" Straight Veneer Bridge	835
7			8,903

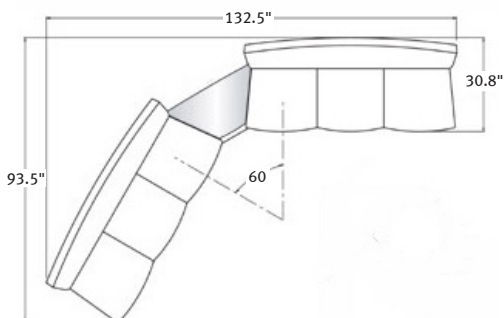

Qty	Model #	Description	COM List
2	4543-G	Sofa, Armless (\$2,514 each)	5,028
1	4560-U	60-Degree Upholstered Bridge	977
3			6,005

SERAFINA MODULAR

designed by david dahl



UPHOLSTERY COMBINATIONS:

For fabric, vinyl or leather upholstery combinations, refer to the pricing below:

- When combining **two** COM/COV/COL fabrics, or fabrics with the same grade, add the following (per unit):
 - › \$65 List for lounge chairs
 - › \$105 List for love seats
 - › \$130 List for sofas
 - When combining **three or more** COM/COV/COL fabrics, or fabrics with the same grade, add the following (per unit):
 - › \$75 List for lounge chairs
 - › \$115 List for love seats
 - › \$140 List for sofas
- When combining different grades of fabric, price will be based on the highest grade specified.
 - Two-tone upholstery examples and yardage requirements for the most common combinations are listed below. Additional combinations available, please contact Customer Service for yardage requirements and pricing.
 - Note: Yardage amounts are based on fabric which is plain (i.e. non-directional) and a full 54" wide.
 - **Appropriate upholstery code must be included on order.**

SIN #711-16



Code SE1

Model COM Requirement
4541-G Seat Cushion Only = 1 yd.
Balance of Chair = 2¹/₂ yds.

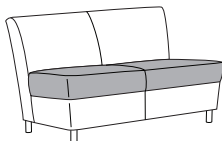

Code SE2

Model COM Requirement
4542-G Seat Cushion Only = 2 yds.
Balance of Love Seat = 3¹/₂ yds.

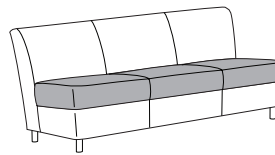

Code SE3

Model COM Requirement
4543-G Seat Cushion Only = 3 yds.
Balance of Sofa = 4¹/₂ yds.

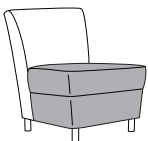

Code SE5

Model COM Requirement
4541-G Inside/Outside Back = 2 yds.
Seat Cushion/Seat Box = 1¹/₂ yds.

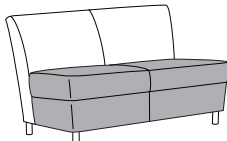

Code SE6

Model COM Requirement
4542-G Inside/Outside Back = 2³/₄ yds.
Seat Cushion/Seat Box = 2¹/₂ yds.

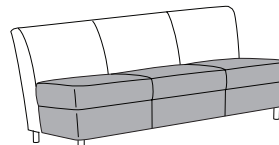

Code SE7

Model COM Requirement
4543-G Inside/Outside Back = 3³/₄ yds.
Seat Cushion/Seat Box = 3¹/₂ yds.

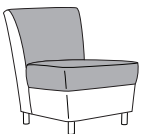

Code SE8

Model COM Requirement
4541-G Inside Back/Seat Cushion = 1¹/₂ yds.
Balance of Chair = 2 yds.

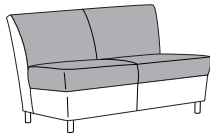

Code SE9

Model COM Requirement
4542-G Inside Back/Seat Cushion = 2³/₄ yds.
Balance of Love Seat = 2³/₄ yds.

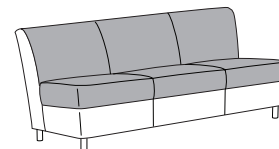

Code SE10

Model COM Requirement
4543-G Inside Back/Seat Cushion = 4 yds.
Balance of Sofa = 3¹/₂ yds.

SERAFINITA KIDS LOUNGE

designed by david dahl



SIN #711-16

PRODUCT FEATURES:

- Fixed seat cushion.
- Fixed leg dimensions: 1^{3/4}" Dia. x 3^{3/4}" H.
- Metal legs available in #90 Metallic Silver, #91 Chrome and #95 Satin Black
- Premium metal finishes also available, refer to colors below. Please specify "-PF02" after model number and add \$80 List per chair.
- For wood fixed legs, please specify "-WL01" after model number with finish selection and add \$110 List per unit.
- All standard and custom wood finishes available on Beech.
- For custom wood finishes, please add one-time upcharge of \$400 List per color per order.
- Non-skid glides available for hard surface floors. Please specify "-NS06B" after model number and add \$20 List per unit.
- Optional casters available on lounge chair only, please specify "-C01" after model number and add \$50 List.
- Mobile version comes standard with two locking casters in rear and two non-locking casters in front.
- Caster color is silver as standard.
- Black casters available, please specify.
- Soft-tread casters available, black color only. Please specify "-C05" and add \$50 List per set (includes 4 casters).
- Maximum weight capacity is 350 lbs. for lounge chairs and 700 lbs. for love seats.
- Please refer to page 3 for two-tone upholstery examples, yardage requirements and pricing.

PREMIUM METAL FINISH COLORS:

#77 Sunshine	#89 Granny Smith
#80 Clementine	#94 Cotton
#83 Metallic Champagne	#98 Pacific
#87 Poppy	#99 Glossy Black
#88 Pink Flamingo	

SERAFINITA KIDS LOUNGE

designed by david dahl



NOTES:

- Legs available in standard and premium metal finishes.
- Beech wood legs also available. Please add \$110 List per unit and specify finish.
- Optional casters available on lounge chair only.
- Refer to page 3 for two-tone upholstery examples and yardage requirements.



SPECIFY:

1. Model number
2. Leg finish
3. Upholstery selection
4. Options, as applicable

ORDERING EXAMPLE:

#4641-NS06B
Lounge Chair
Non-Skid Glides

SIN #711-16

MODEL NUMBER	PRODUCT SPECIFICATIONS	FABRIC GRADES							LEATHER GRADES				
		COM	1	2	COL			8	L1	L2	L3		
4641 	Children's Lounge Chair W 20 D 24 H 27 Seat Height 15 Seat Width 19 Seat Depth 16 2 Yds. 40 lbs. COL 40 Sq. Ft. TB 133, add \$96 List	1049	1163	1190	1238	1287	1333	1381	1425	1474	1694	1856	2013
		1587	1814	1869	1965	2062	2154	2251	2339	2436	2877	3200	3515
4642 	Children's Love Seat W 38 D 24 H 27 Seat Height 15 Seat Width 38 Seat Depth 16 4 Yds. 55 lbs. COL 80 Sq. Ft. TB 133, add \$192 List												

OPTIONS (XXXX - REFERS TO CHAIR MODEL NUMBER)		
MODEL	DESCRIPTION	LIST
XXXX-PF02	Premium Leg Finish	80
XXXX-WL01	Wood Legs	110
XXXX-NS06B	Non-Skid Glides	20
XXXX-C01	Castors (set of 4), Silver or Black, please specify	50
XXXX-C05	Soft Tread Castors (set of 4)	50

UPHOLSTERY COMBINATIONS:

For fabric, vinyl or leather upholstery combinations, refer to the pricing below:

- When combining **two** COM/COV/COL fabrics, or fabrics with the same grade, add the following (per unit):
 - › \$65 List for lounge chairs
 - › \$105 List for love seats
- When combining **three or more** COM/COV/COL fabrics, or fabrics with the same grade, add the following (per unit):
 - › \$75 List for lounge chairs
 - › \$115 List for love seats
- When combining different grades of fabric, price will be based on the highest grade specified.
- Two-tone upholstery examples and yardage requirements for the most common combinations are listed below. Additional combinations available, please contact Customer Service for yardage requirements and pricing.
- Note: Yardage amounts are based on fabric which is plain (i.e. non-directional) and a full 54" wide.
- **Appropriate upholstery code must be included on order.**

SERAFINITA KIDS LOUNGE

designed by david dahl



SIN #711-16



Code SN1

Model COM Requirement
4641 Seat Cushion Only = $\frac{3}{4}$ yd.
Balance of Chair = $1\frac{1}{2}$ yds.

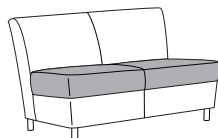

Code SN2

Model COM Requirement
4642 Seat Cushion Only = $1\frac{1}{4}$ yds.
Balance of Love Seat = $2\frac{1}{4}$ yds.



Code SN3

Model COM Requirement
4641 Inside/Outside Back = $1\frac{1}{4}$ yds.
Seat Cushion/Seat Box = 1 yd.

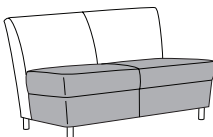

Code SN4

Model COM Requirement
4642 Inside/Outside Back = $1\frac{3}{4}$ yds.
Seat Cushion/Seat Box = $1\frac{3}{4}$ yds.

SERAFINITA KIDS MODULAR

designed by david dahl



SIN #711-16

LOUNGE PRODUCT FEATURES:

- Single and 2-seat armless units.
- Fixed seat cushion.
- Metal legs available in #90 Metallic Silver, #91 Chrome and #95 Satin Black.
- Premium metal finishes also available, refer to colors below. Please specify “-PF02” after model number and add \$80 List per chair.
- For wood fixed legs, please specify “-WL01” after model number with finish selection and add \$110 List per unit.
- All standard and custom wood finishes available on Beech.
- For custom wood finishes (to legs and/or connecting bridges), please add one-time upcharge of \$400 List per color per order.
- Non-skid glides available for hard surface floors. Please specify “-NS06B” after model number and add \$20 List per unit.
- Each unit comes standard with 4 concealed linking connectors.
- Linking connectors pivot outward from underneath chair to link with bridges.
- Maximum weight capacity is 350 lbs. for lounge chairs and 700 lbs. for love seats.
- Please refer to page 4 for two-tone upholstery examples, yardage requirements and pricing.
- Serafinita lounge and love seat units cannot be ganged with standard Serafina Modular connecting tables.
- All dimensions are nominal.

PREMIUM METAL FINISH COLORS:

#77 Sunshine	#89 Granny Smith
#80 Clementine	#94 Cotton
#83 Metallic Champagne	#98 Pacific
#87 Poppy	#99 Glossy Black
#88 Pink Flamingo	

CORIAN® COLORS:

Designer White	Sahara (T)
Rain Cloud	Sonora
Linen	Platinum (T)
Witch Hazel	

CONNECTING BRIDGETTES:

- Available in four sizes: 6" wide straight, 30-degree, 45-degree and 90-degree.
- Top features radiused edge.
- Bridgettes available in Beech veneer, laminate and Corian.
- All standard and custom wood finishes available on Beech.
- For custom wood finishes (to legs and/or connecting bridges), please add one-time upcharge of \$400 List per color per order.
- Corian top is 1/2" thick in lieu of standard table top thickness of 3/4".
- Corian top available in seven standard colors. For non-standard colors, please contact Customer Service for pricing.
- Laminate and Corian tops feature veneer body as standard, please specify wood species and finish.
- For laminate top and body, or Corian top with laminate body, please specify and contact Customer Service for pricing.
- Fixed legs support bridges and allow them to stand alone.
- Metal legs available in #90 Metallic Silver, #91 Chrome and #95 Satin Black
- Premium metal finishes also available, refer to colors below. Please specify “-PF02” after model number and add \$80 List per chair.
- Non-skid glides available for hard surface floors. Please specify “-NS02B” after model number and add \$20 List per unit.
- Each unit comes standard with 4 fixed linking receivers.
- All connecting bridges are interchangeable and reversible.
- When reversing connecting bridges, angles will vary by 11-degrees (e.g. 30-degree bridge when reversed becomes a 41-degree angle).
- Note: Due to the geometry of the connecting bridges, dimensions listed are nominal.
- All table sizes can be connected to Serafina Modular seating units.
- **Note: For safety reasons, it is not recommended to start or end a modular configuration with any connecting bridge.**
- All dimensions are nominal.

SERAFINITA KIDS MODULAR

designed by david dahl



NOTES:

- Metal leg available in standard and premium metal finishes, refer to page 1 for options.
- For wood fixed legs, add \$110 List and specify finish.
- Each unit comes standard with 4 concealed linking connectors.
- Refer to page 4 for two-tone upholstery examples and yardage requirements.



SPECIFY:

1. Model number
2. Leg finish
3. Upholstery selection
4. Options, as applicable

ORDERING EXAMPLE:

#4541-G-PF02
Lounge Chair
Premium Leg Finish

SIN #711-16

MODEL NUMBER	PRODUCT SPECIFICATIONS	FABRIC GRADES							LEATHER GRADES				
		COM	1	2	COL			8	L1	L2	L3		
4641-G	 <p>Children's Armless Lounge Chair, Ganging Bracket W 20 D 24 H 27 Seat Height 15 Seat Width 19 Seat Depth 16 2 Yds. 40 lbs. COL 40 Sq. Ft. TB 133, add \$96 List</p>	1169	1283	1310	1358	1407	1453	1501	1545	1594	1814	1976	2133
4642-G	 <p>Children's Armless Love Seat, Ganging Bracket W 38 D 24 H 27 Seat Height 15 Seat Width 38 Seat Depth 16 4 Yds. 55 lbs. COL 80 Sq. Ft. TB 133, add \$192 List</p>	1709	1936	1991	2087	2184	2276	2373	2461	2558	2999	3322	3637

OPTIONS (XXXX - REFERS TO CHAIR MODEL NUMBER)

MODEL	DESCRIPTION	LIST
XXXX-PF02	Premium Leg Finish	80
XXXX-WL01	Wood Legs	110
XXXX-NS06B	Non-Skid Glides	20

NOTES:

- Bridges standard with Beech veneer. Laminate and Corian tops available, please specify.
- Metal leg available in standard and premium metal finishes, refer to page 1 for options
- For wood fixed legs, add \$110 List and specify finish.
- Each unit comes standard with 4 fixed linking receivers.
- All connecting bridges are inter-changeable and reversible.
- When reversing connecting bridges, angles will vary by 11-degrees (e.g. 30-degree bridge when reversed becomes a 41-degree angle).

SPECIFY:

1. Model number
2. Wood finish
3. Leg finish
4. Options, as applicable

ORDERING EXAMPLE:

#4530-W-CO-NS06B



30-Degree Bridge
Corian Top
Non-Skid Glides

SERAFINITA KIDS MODULAR

designed by david dahl

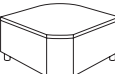

SIN #711-16

MODEL NUMBER	PRODUCT SPECIFICATIONS	TABLE TOP FINISH	
		VENEER OR LAMINATE	CORIAN (-CO)
4606-W 	Connecting Bridge 6" Straight Closed (Front & Back) W 5 ³ / ₄ D 17 ¹ / ₂ H 13 15 lbs.	792	973
4630-W 	Connecting Bridge 30-Degree Closed (Front & Back) W 9 D 16 ¹ / ₄ H 13 19 lbs.	838	1533
4645-W 	Connecting Bridge 45-Degree Closed (Front & Back) W 9 ¹ / ₄ D 15 ¹ / ₂ H 13 23 lbs.	863	1557
4690-W 	Connecting Bridge 90-Degree Closed (Front & Back) W 4 D 22 H 13 30 lbs.	1362	2061

OPTIONS (XXXX - REFERS TO TABLE MODEL NUMBER)

MODEL	DESCRIPTION	LIST
XXXX-PF02	Premium Leg Finish	80
XXXX-WL01	Wood Legs	110
XXXX-NS06B	Non-Skid Glides	20

SERAFINITA KIDS MODULAR

designed by david dahl



UPHOLSTERY COMBINATIONS:

For fabric, vinyl or leather upholstery combinations, refer to the pricing below:

- When combining **two** COM/COV/COL fabrics, or fabrics with the same grade, add the following (per unit):
 - › \$65 List for lounge chairs
 - › \$105 List for love seats
- When combining **three or more** COM/COV/COL fabrics, or fabrics with the same grade, add the following (per unit):
 - › \$75 List for lounge chairs
 - › \$115 List for love seats
- When combining different grades of fabric, price will be based on the highest grade specified.
- Two-tone upholstery examples and yardage requirements for the most common combinations are listed below. Additional combinations available, please contact Customer Service for yardage requirements and pricing.
- Note: Yardage amounts are based on fabric which is plain (i.e. non-directional) and a full 54" wide.
- **Appropriate upholstery code must be included on order.**

SIN #711-16



Code SN1

Model COM Requirement
4641-G Seat Cushion Only = $\frac{3}{4}$ yd.
Balance of Chair = $1\frac{1}{2}$ yds.

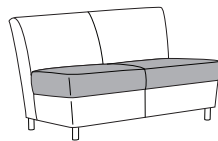

Code SN2

Model COM Requirement
4642-G Seat Cushion Only = $1\frac{1}{4}$ yds.
Balance of Love Seat = $2\frac{1}{4}$ yds.



Code SN3

Model COM Requirement
4641-G Inside/Outside Back = $1\frac{1}{4}$ yds.
Seat Cushion/Seat Box = 1 yd.

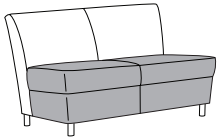

Code SN4

Model COM Requirement
4642-G Inside/Outside Back = $1\frac{3}{4}$ yds.
Seat Cushion/Seat Box = $1\frac{3}{4}$ yds.

NOTES:

- Rectangular steel cantilever frame available in two finishes: #90 Metallic Silver and #91 Chrome.
- Three arm cap options: Beech wood, black urethane or Corian.
- All standard and custom finishes on Beech.
- For custom wood finishes, please add one-time upcharge of \$400 List per color per order.
- Corian available in four standard colors (see below for options). For non-standard colors, please contact Customer Service for pricing.
- Black glides standard.
- 275 lbs. maximum weight capacity.
- All dimensions are nominal.

SPECIFY:

1. Model number
2. Arm cap finish, as applicable
3. Frame finish
4. Upholstery selection
5. Options, as applicable

ORDERING EXAMPLE:

#980-CO-GD02



Guest Chair, Corian Arm Caps
Felt Glides

**SIGN
GUEST**

licensed from wiesner-hager, austria



SIN #711-18

MODEL NUMBER	PRODUCT SPECIFICATIONS	FABRIC GRADES							LEATHER GRADES							
		COM	1	2	COL			3	4	5	6	7	8	L1	L2	L3
980 	Q S Guest Chair Wood Arm Cap W 21 ¹ / ₂ D 24 ³ / ₄ H 33 Seat Height 18 ³ / ₄ Inside Seat Width 19 Inside Seat Depth 17 ¹ / ₂ Arm Height 26 1 ¹ / ₂ Yds. 30 lbs. TB 133, add \$72 List	1226	1312	1332	1368	1404	1439	1475	1508	1545	1710	1831	1949			
980-U 	Q S Guest Chair Black Urethane Arm Cap W 21 ¹ / ₂ D 24 ³ / ₄ H 33 Seat Height 18 ³ / ₄ Inside Seat Width 19 Inside Seat Depth 17 ¹ / ₂ Arm Height 26 1 ¹ / ₂ Yds. 30 lbs. TB 133, add \$72 List	1226	1312	1332	1368	1404	1439	1475	1508	1545	1710	1831	1949			

Corian Arm Cap Colors:
 Designer White
 Linen
 Rain Cloud
 Witch Hazel

OPTIONS (XXXX - REFERS TO CHAIR MODEL NUMBER)		
MODEL	DESCRIPTION	LIST
XXXX-CO	Corian Arm Caps	100
XXXX-GD02	Felt Glides	20

Q S = Available on Quick-Ship Program (excluding Corian arm caps).



SILERO GUEST-TANDEM

designed by david dahl
and carl muller



SIN #711-16

SEATING PRODUCT FEATURES:

- Guest chairs available with partial or closed upholstered back options.
- Bariatric chair offered with partial upholstered back only.
- Two arm options: open arm or upholstered panel arm.
- All standard and custom wood finishes available on Beech.
- For custom wood finishes, please add one-time upcharge of \$400 List per color per order.
- Corian arm caps available in four standard colors. For non-standard colors, please contact Customer Service for pricing.
- Radius arm option offered, please specify and add \$25 List per arm.
- Two, three and four-seat preconfigured tandem combinations offered.
- Non-skid glides available for hard surface floors. Refer to individual pages for specification information and pricing.
- Wall saver leg design available on guest models at no upcharge, please specify "-WS" after model number.
- Replaceable seat cover and moisture barrier (seats only) available. Refer to individual pages for specification information and pricing.
- All dimensions are nominal.

CORIAN® COLORS:

Designer White
Linen
Rain Cloud
Witch Hazel

Corian® is a registered trademark of Dupont.

WEIGHT CAPACITY:

- Guest Chair 275 lbs.
- Preconfigured Tandem 275 lbs. per seat
- Bariatric Chairs 750 lbs.

CONNECTING TABLES PRODUCT FEATURES:

- End, in-line and corner table options.
- Custom sizes available, contact Customer Service for pricing.
- All tops are 1" thick.
- Tables available in Beech veneer as well as laminate and Corian.
- All standard and custom wood finishes available on Beech.
- For custom wood finishes, please add \$400 List per color per order.
- When ordering in laminate, specify laminate manufacturer, color and pattern number.
- If standard laminate is specified, no upcharge.
- For custom laminates, add \$500 List per color per order. Pre-approval required, please contact Customer Service.
- Veneer and laminate tables feature matching edges as standard.
- For Corian top, specify "-CO" next to model number. Corian top is 1/2" thick in lieu of standard table top thickness of 1".
- Non-skid glides available for hard surface floors. Refer to individual page for specification information and pricing.
- For tables mounted to units with Panel Arms (PA), add 2" to overall length of seating configuration. Applies to models 4740, 4745, 4750 and 4755.
- Tables are field installed.
- **Note: Please include seating/table layout drawings or sketch with each order.**
- All dimensions are nominal.

SILERO GUEST-TANDEM

designed by david dahl
and carl muller



SIN #711-16

NOTES:

- Beech hardwood frame.
- Guest chairs available with partial or closed upholstered back options.
- Bariatric chair offered with partial upholstered back only.





SPECIFY:

1. Model number
2. Wood finish
3. Upholstery selection
4. Options, as applicable

ORDERING EXAMPLE:

#4710-WS-SC01

Open Arm Guest Chair
Wall-Saver Leg
Replaceable Seat Cover

MODEL NUMBER	PRODUCT SPECIFICATIONS	FABRIC GRADES								LEATHER GRADES			
		COM	1	2	COL			6	7	8	L1	L2	L3
4710 	Guest Chair, Open Arm Partial Upholstered Back W 22 ¹ / ₄ D 24 ¹ / ₂ H 33 ³ / ₄ Seat Height 18 Inside Seat Width 19 ¹ / ₄ Inside Seat Depth 19 ¹ / ₂ Arm Height 26 ³ / ₄ 1 ¹ / ₂ Yds. 27 lbs. TB 133, add \$72 List	1002	1088	1108	1144	1180	1215	1251	1284	1321	1486	1607	1725
4720 	Guest Chair, Open Arm Closed Upholstered Back W 22 ¹ / ₄ D 24 ¹ / ₂ H 33 ³ / ₄ Seat Height 18 Inside Seat Width 19 ¹ / ₄ Inside Seat Depth 19 ¹ / ₂ Arm Height 26 ³ / ₄ 1 ¹ / ₂ Yds. 29 lbs. TB 133, add \$72 List	1026	1112	1132	1168	1204	1239	1275	1308	1345	1510	1631	1749
4720-PA 	Guest Chair Closed Upholstered Back Upholstered Panel Arm W 22 ¹ / ₄ D 24 ¹ / ₂ H 33 ³ / ₄ Seat Height 18 Inside Seat Width 19 ¹ / ₄ Inside Seat Depth 19 ¹ / ₂ Arm Height 26 ³ / ₄ 2 ¹ / ₂ Yds. 34 lbs. TB 133, add \$120 List	1244	1386	1420	1481	1541	1599	1659	1714	1775	2050	2252	2449
4790 	Bariatric Chair, Open Arm Partial Upholstered Back W 33 ¹ / ₂ D 24 ¹ / ₂ H 33 Seat Height 18 Inside Seat Width 30 Inside Seat Depth 19 ¹ / ₂ Arm Height 26 ³ / ₄ 2 ¹ / ₂ Yds. 44 lbs. TB 133, add \$120 List	1298	1440	1474	1535	1595	1653	1713	1768	1829	2104	2306	2503

OPTIONS (XXXX - REFERS TO CHAIR MODEL NUMBER)

MODEL	DESCRIPTION	LIST
XXXX-CO	Corian Arm Caps	130
XXXX-WS	Wall-Saver Leg (excluding model #4790)	n/c
XXXX-RA02	Radius Arm	50
XXXX-NS02B	Non-Skid Glides	20
XXXX-SC01	Replaceable Seat Cover, Guest Chair	45
XXXX-SC02	Replaceable Seat Cover, Bariatric Chair	60
XXXX-MB01	Moisture Barrier, Guest Chair (seat only)	50
XXXX-MB02	Moisture Barrier, Bariatric Chair (seat only)	95

NOTES:

- Beech hardwood frame.
- Partial or closed upholstered back option.
- Please refer to page 5 for connecting table options.
- Please include seating layout drawings or sketch with each order.

SPECIFY:

1. Model number
2. Wood finish
3. Upholstery selection
4. Options, as applicable

ORDERING EXAMPLE:

#4712-CO-NS02A





Partial Back Two-Seater
Corian Arm Caps
Non-Skid Glides

SILERO GUEST-TANDEM

designed by david dahl
and carl muller



SIN #711-17

MODEL NUMBER	PRODUCT SPECIFICATIONS	FABRIC GRADES							LEATHER GRADES				
		COM	1	2	COL			4	5	6	7	8	L1
4711 	Arm Chair, Open Arm Partial Upholstered Back W 22 ¹ / ₄ D 24 ¹ / ₂ H 33 ³ / ₄ Seat Height 18 Inside Seat Width 19 ¹ / ₄ Inside Seat Depth 19 ¹ / ₂ Arm Height 26 ³ / ₄ 1 ¹ / ₂ Yds. 27 lbs. TB 133, add \$72 List	1002	1088	1108	1144	1180	1215	1251	1284	1321	1486	1607	1725
4712 	Two-Seater, Open Arm Partial Upholstered Back W 43 D 24 ¹ / ₂ H 33 ³ / ₄ Seat Height 18 Inside Seat Width 19 ¹ / ₄ Inside Seat Depth 19 ¹ / ₂ Arm Height 26 ³ / ₄ 3 Yds. 37 lbs. TB 133, add \$144 List	1709	1880	1921	1993	2065	2135	2207	2273	2346	2677	2919	3155
4713 	Three-Seater, Open Arm Partial Upholstered Back W 63 ³ / ₄ D 24 ¹ / ₂ H 33 ³ / ₄ Seat Height 18 Inside Seat Width 19 ¹ / ₄ Inside Seat Depth 19 ¹ / ₂ Arm Height 26 ³ / ₄ 4 ¹ / ₂ Yds. 51 lbs. TB 133, add \$216 List	2436	2692	2753	2862	2970	3074	3183	3282	3391	3887	4251	4605
4714 	Four-Seater, Open Arm Partial Upholstered Back W 86 D 24 ¹ / ₂ H 33 ³ / ₄ Seat Height 18 Inside Seat Width 19 ¹ / ₄ Inside Seat Depth 19 ¹ / ₂ Arm Height 26 ³ / ₄ 6 Yds. 65 lbs. TB 133, add \$288 List	3125	3466	3548	3692	3837	3976	4121	4253	4398	5060	5545	6017

OPTIONS (XXXX - REFERS TO CHAIR MODEL NUMBER)

MODEL	DESCRIPTION	LIST
XXXX-CO	Corian Arm Cap (per arm)	65
XXXX-WS	Wall-Saver Leg	n/c
XXXX-PA	Upholstered Panel Arm (per arm and add 1/2 yard each)	79
XXXX-RA01	Radius Arm (per arm)	25
XXXX-NS02A	Non-Skid Glides (per arm frame)	10
XXXX-SC01	Replaceable Seat Cover (per seat)	45
XXXX-MB01	Moisture Barrier (seat only, per seat)	50

SILERO GUEST-TANDEM

designed by david dahl
and carl muller



NOTES:

- Beech hardwood frame.
- Partial or closed upholstered back option.
- Please refer to page 5 for connecting table options.
- Please include seating layout drawings or sketch with each order.

SPECIFY:





1. Model number
2. Wood finish
3. Upholstery selection
4. Options, as applicable

ORDERING EXAMPLE:

#4721-WS-NS02A

Closed Back Chair
Wall-Saver Leg
Non-Skid Glides

SIN #711-17

MODEL NUMBER	PRODUCT SPECIFICATIONS	FABRIC GRADES								LEATHER GRADES			
		COM	1	2	COL			6	7	8	L1	L2	L3
4721 	Arm Chair, Open Arm Closed Upholstered Back W 22 ¹ / ₄ D 24 ¹ / ₂ H 33 ³ / ₄ Seat Height 18 Inside Seat Width 19 ¹ / ₄ Inside Seat Depth 19 ¹ / ₂ Arm Height 26 ³ / ₄ 1 ¹ / ₂ Yds. 27 lbs. TB 133, add \$72 List	1002	1088	1108	1144	1180	1215	1251	1284	1321	1486	1607	1725
		1709	1880	1921	1993	2065	2135	2207	2273	2346	2677	2919	3155
4722 	Two-Seater, Open Arm Closed Upholstered Back W 43 D 24 ¹ / ₂ H 33 ³ / ₄ Seat Height 18 Inside Seat Width 19 ¹ / ₄ Inside Seat Depth 19 ¹ / ₂ Arm Height 26 ³ / ₄ 3 Yds. 39 lbs. TB 133, add \$144 List	2436	2692	2753	2862	2970	3074	3183	3282	3391	3887	4251	4605
		3125	3466	3548	3692	3837	3976	4121	4253	4398	5060	5545	6017
4723 	Three-Seater, Open Arm Closed Upholstered Back W 63 ³ / ₄ D 24 ¹ / ₂ H 33 ³ / ₄ Seat Height 18 Inside Seat Width 19 ¹ / ₄ Inside Seat Depth 19 ¹ / ₂ Arm Height 26 ³ / ₄ 4 ¹ / ₂ Yds. 53 lbs. TB 133, add \$216 List												
4724 	Four-Seater, Open Arm Closed Upholstered Back W 86 D 24 ¹ / ₂ H 33 ³ / ₄ Seat Height 18 Inside Seat Width 19 ¹ / ₄ Inside Seat Depth 19 ¹ / ₂ Arm Height 26 ³ / ₄ 6 Yds. 69 lbs. TB 133, add \$288 List												

OPTIONS (XXXX - REFERS TO CHAIR MODEL NUMBER)

MODEL	DESCRIPTION	LIST
XXXX-CO	Corian Arm Cap (per arm)	65
XXXX-WS	Wall-Saver Leg	n/c
XXXX-PA	Upholstered Panel Arm (per arm and add 1/2 yard each)	79
XXXX-RA01	Radius Arm (per arm)	25
XXXX-NS02A	Non-Skid Glides (per arm frame)	10
XXXX-SC01	Replaceable Seat Cover (per seat)	45
XXXX-MB01	Moisture Barrier (seat only, per seat)	50

NOTES:

- Tables available in Beech veneer as well as laminate and Corian.
- Corian top is 1/2" thick in lieu of standard table top thickness of 1".
- Tables are field installed.
- For tables mounted to units with Panel Arms (PA), add 2" to overall length of seating configuration. Applies to models 4740, 4745, 4750 and 4755.
- Please include seating layout drawings or sketch with each order.

SPECIFY:

1. Model number
2. Wood finish
3. Options, as applicable

ORDERING EXAMPLE:

#4755-CO-NS02A



Left End Table
Corian Top
Non-Skid Glides

SILERO GUEST-TANDEM

designed by david dahl
and carl muller

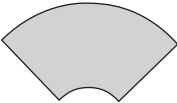

SIN #711-16

MODEL NUMBER	PRODUCT SPECIFICATIONS	TABLE TOP FINISH	
		VENEER OR LAMINATE	CORIAN (-CO)
4740 	24" Table Top (In-line add-on) W 24 D 16 ⁷ / ₈ 15 lbs. Field Installed	498	1139
4745 	Corner Table W 25 D 25 18 lbs. Field Installed	581	1586
4750 	Right End Table (Facing) W 24 D 16 ⁷ / ₈ H 18 22 lbs. Field Installed	608	1252
4755 	Left End Table (Facing) W 24 D 16 ⁷ / ₈ H 18 22 lbs. Field Installed	608	1252

OPTIONS (XXXX - REFERS TO TABLE MODEL NUMBER)

MODEL	DESCRIPTION	LIST
XXXX-NS02A	Non-Skid Glides (per table)	10

NOTES:

- All standard wood finishes available on Beech legs.
- For custom wood finishes, please add one-time upcharge of \$400 List per color per order.
- Maximum weight capacity is 350 lbs. for lounge chairs, 700 lbs. for love seats and 1000 lbs. for sofas.
- Refer to page 3 for two-tone upholstery examples and yardage requirements.

SPECIFY:

1. Model number
2. Wood leg finish
3. Upholstery selection
4. Options, as applicable

ORDERING EXAMPLE:

#1921-CHR03

Lounge Chair
Cup-Holder, Right

SOLANA LOUNGE

designed by david dahl & carl muller

PLEASE NOTE THAT
EFFECTIVE JULY 15TH, 2019,
A 3% TARIFF SURCHARGE
WILL BE APPLIED TO THE NET
SUBTOTAL ON ALL ORDERS.

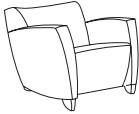
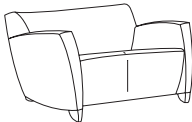
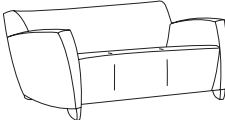

SIN #711-16

MODEL NUMBER	PRODUCT SPECIFICATIONS	FABRIC GRADES							LEATHER GRADES							
		COM	1	2	COL			3	4	5	6	7	8	L1	L2	L3
1921	 <p>Lounge Chair W 32 D 31 H 30 Seat Height 17 Inside Seat Width 22 Inside Seat Depth 18¹/₂ Arm Height 26¹/₄ 5 Yds. 71 lbs. COL 100 Sq. Ft. TB 133, add \$230 List</p>	1593	1877	1945	2066	2187	2302	2423	2533	2654	3205	3609	4003			
1922	 <p>Love Seat W 54 D 31 H 30 Seat Height 17 Inside Seat Width 44 Inside Seat Depth 18¹/₂ Arm Height 26¹/₄ 7 Yds. 102 lbs. COL 140 Sq. Ft. TB 133, add \$322 List</p>	2183	2580	2676	2845	3014	3176	3345	3499	3668	4440	5006	5557			
1923	 <p>Sofa W 76 D 31 H 30 Seat Height 17 Inside Seat Width 66 Inside Seat Depth 18¹/₂ Arm Height 26¹/₄ 9 Yds. 133 lbs. COL 180 Sq. Ft. TB 133, add \$414 List</p>	2903	3414	3537	3754	3971	4179	4397	4595	4812	5805	6532	7241			

OPTIONS (XXXX - REFERS TO CHAIR MODEL NUMBER)

MODEL	DESCRIPTION	LIST
XXXX-CHR03	In-Arm Recessed Cup Holder, Right (as seated)	250
XXXX-CHL03	In-Arm Recessed Cup Holder, Left (as seated)	250
XXXX-NS02B	Non-Skid Glides	20

SOLANA LOUNGE

designed by david dahl & carl muller



NOTES:

- High back lounge chair available with Beech wood legs or casters.
- For custom wood finishes, please add one-time upcharge of \$400 List per color per order.
- Mobile version comes standard with two locking casters in rear and two non-locking casters in front.
- Maximum weight capacity is 350 lbs.
- Refer to page 3 for two-tone upholstery examples and yardage requirements.



SPECIFY:

1. Model number
2. Wood leg finish, as applicable
3. Upholstery selection
4. Options, as applicable

ORDERING EXAMPLE:

#1921-HB-C-P01
 High Back Lounge Chair
 Casters
 Pull Handle

SIN #711-16

MODEL NUMBER	PRODUCT SPECIFICATIONS	FABRIC GRADES								LEATHER GRADES			
		COM	1	2	COL			6	7	8	L1	L2	L3
1921-HB 	High Back Lounge Chair W 33 D 31 H 35 Seat Height 17 Inside Seat Width 22 Inside Seat Depth 18 ¹ / ₂ Arm Height 27 5 ¹ / ₂ Yds. 80 lbs. COL 110 Sq. Ft. TB 133, add \$253 List	1605	1917	1992	2125	2258	2385	2518	2639	2772	3378	3823	4256
		1574	1886	1961	2094	2227	2354	2487	2608	2741	3347	3792	4225
1921-HB-C 	High Back Lounge Chair, Casters W 32 D 31 H 35 Seat Height 17 Inside Seat Width 22 Inside Seat Depth 18 ¹ / ₂ Arm Height 26 ¹ / ₄ 5 ¹ / ₂ Yds. 71 lbs. COL 110 Sq. Ft. TB 133, add \$253 List												

OPTIONS (XXXX - REFERS TO CHAIR MODEL NUMBER)		
MODEL	DESCRIPTION	LIST
XXXX-CHR03	In-Arm Recessed Cup Holder, Right (as seated)	250
XXXX-CHL03	In-Arm Recessed Cup Holder, Left (as seated)	250
XXXX-P01	Pull Handle (available on model #1921-HB-C only)	50
XXXX-NS02B	Non-Skid Glides	20
XXXX-C05	Soft Tread Casters	50

UPHOLSTERY COMBINATIONS:

For fabric, vinyl or leather upholstery combinations, refer to the pricing below:

- When combining **two** COM/COV/COL fabrics, or fabrics with the same grade, add the following (per unit):
 - › \$65 List for lounge chairs
 - › \$105 List for love seats
 - › \$130 List for sofas
- When combining **three or more** COM/COV/COL fabrics, or fabrics with the same grade, add the following (per unit):
 - › \$75 List for lounge chairs
 - › \$115 List for love seats
 - › \$140 List for sofas

- When combining different grades of fabric, price will be based on the highest grade specified.
- Two-tone upholstery examples and yardage requirements for the most common combinations are listed below. Additional combinations available, please contact Customer Service for yardage requirements and pricing.
- Note: Yardage amounts are based on fabric which is plain (i.e. non-directional) and a full 54" wide.
- **Appropriate upholstery code must be included on order.**

SOLANA LOUNGE

designed by david dahl & carl muller



SIN #711-16

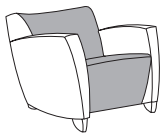

Code S01

Model COM Requirement

1921 Inside Back/Top & Front of Seat = 1¹/₂ yds.
Balance of Chair = 4 yds.

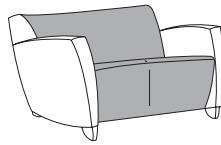

Code S02

Model COM Requirement

1922 Inside Back/Top & Front of Seat = 3 yds.
Balance of Love Seat = 4³/₄ yds.

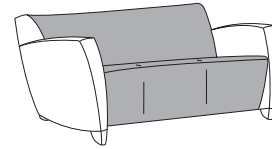

Code S03

Model COM Requirement

1923 Inside Back/Top & Front of Seat = 4¹/₄ yds.
Balance of Sofa = 5 yds.



Code S07

Model COM Requirement

1921-HB Inside Back/Top & Front of Seat = 1³/₄ yds.
Balance of Chair = 4¹/₄ yds.

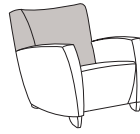

Code S08

Model COM Requirement

1921-HB Inside Back/Top & Front of Seat = 1¹/₄ yds.
Balance of Chair = 4¹/₄ yds.

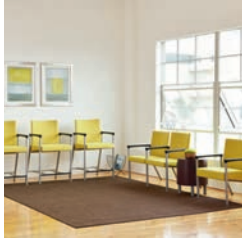

SOLEIL GUEST-TANDEM

designed by david dahl



SIN #711-17

PRODUCT FEATURES:

- Metal frame available in standard and premium finishes. See below for options.
- For premium metal finishes, please refer to individual pages for applicable upcharge.
- Three arm cap options: wood, black urethane and Corian.
- Wood arm caps available in Beech, Walnut and White Oak.
- All standard and custom wood finishes available.
- For custom wood finishes, please add one-time upcharge of \$400 List per color per order.
- Corian arm caps available in four standard colors. For non-standard colors, please contact Customer Service for pricing.
- For Corian arm caps, a wood species and finish must be specified for the arm cap lower portion.
- Bariatric settee available in two sizes.
- Two, three and four-seat preconfigured tandem combinations offered.
- Non-skid glides available for hard surface floors. Refer to individual pages for specification information and pricing.
- Please refer to page 15 for two-tone upholstery examples, yardage requirements and pricing.
- All dimensions are nominal.

METAL FINISH COLORS:

- #06 Charcoal Grey
- #90 Metallic Silver

PREMIUM FINISH COLORS:

- #07 Gold Shimmer
- #08 Penny
- #09 Brown Sugar
- #83 Metallic Champagne
- #94 Cotton

CORIAN® COLORS:

- Designer White
- Rain Cloud
- Linen
- Witch Hazel

Corian® is a registered trademark of Dupont.

WEIGHT CAPACITY:

- Guest Chair 350 lbs.
- Preconfigured Tandem 350 lbs. per seat
- Reconfigurable Tandem 350 lbs. per seat
- Bariatric Chairs 750 lbs.
- Easy Access/Hip Chairs 350 lbs.
- Patient Chairs 350 lbs.

SOLEIL GUEST-TANDEM

designed by david dahl



SIN #711-17

SPECIAL FEATURES:



- Arm cap features radiused edges for smooth surface contact.
- All styles field-replaceable.



- Flex back featured on all models including bariatric sizes, patient chair and hip chair.
- Passive flex back motion provides long-term seated comfort.



- Clean-outs on every side, including between the seat and back, featured on all models including bariatric sizes, patient chair and easy access/hip chair.
- Enables crumbs and debris to fall through for maintenance ease.



- Metal seat frame construction ensures durability and allows in-field component replacement as well as add-on capability for tandem units.

- Wall-saver leg design.
- Optional replaceable seat upholstery available on all seating models including bariatric sizes as well as the easy access/hip and patient chair.
- Replacement seat covers can be easily field installed on previously ordered Soleil models with standard fixed upholstery. Contact Customer Service for instructions.
- For the complete list of replaceable components, please refer to pages 10-13.

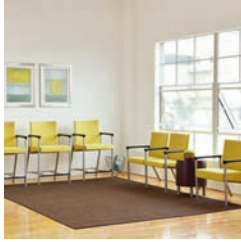

SOLEIL GUEST-TANDEM

designed by david dahl



SIN #711-17

TANDEM MODULAR UNITS PRODUCT FEATURES:

- To build tandem configurations, always specify units from left-to-right, as facing.
- Seats, together with backs, are specified individually, as are arm frame units.
- In-line, corner and end tables available for reconfigurable modular units only.
- Tables available in Beech, Walnut and White Oak veneer as well as laminate and Corian.
- Veneer and laminate tables are 3³/₄" wide at its thickest point in back, and narrows to 1¹/₄" wide in front.
- Veneer and laminate tables feature matching edges as standard.
- Corian top is affixed to table surface increasing overall table height by 1/2".
- **Table with Corian top, wood edge species and finish selection must be specified.**
- All standard and custom wood finishes available.
- For custom wood finishes, please add \$400 List per color per order.
- When ordering in laminate, specify laminate manufacturer, color and pattern number.
- If standard laminate is specified, no upcharge.
- For custom laminates, add \$500 List per color per order. Pre-approval required, please contact Customer Service.
- **Note: Please include seating/table layout drawings or sketch with each order.**
- Arcadia will pre-assemble units at the factory to maximize shipping allowances and minimize field assembly.

SOLEIL GUEST-TANDEM

designed by david dahl



SIN #711-17

NOTES:

- Wood arm caps available in Beech, Walnut and White Oak.
- For Corian arm caps, a wood species and finish must be specified for the lower portion of the arm cap.
- Please specify option code after model number and add upcharges accordingly.
- Refer to page 15 for two-tone upholstery examples and yardage requirements.



SPECIFY:

1. Model number
2. Upper arm cap finish
3. Lower arm cap finish, as applicable
4. Frame finish
5. Upholstery selection
6. Options, as applicable

ORDERING EXAMPLE:

#4410-U-SC01-MB01

Guest Chair
Black Urethane Arms
Replaceable Seat Cover
Moisture Barrier

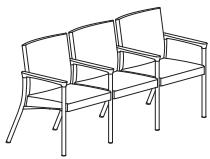
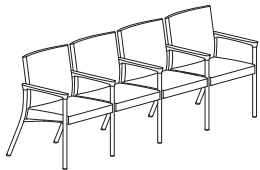
MODEL NUMBER	PRODUCT SPECIFICATIONS	FABRIC GRADES										LEATHER GRADES		
		ARM CAPS	COL	1	2	3	4	5	6	7	8	L1	L2	L3
4410-W (WOOD ARM CAPS) 4410-U (URETHANE ARM CAPS) 4410-CO (CORIAN ARM CAPS) 	Single Guest Chair Q S W 24 ¹ / ₂ D 26 ¹ / ₂ H 34 Seat Height 18 Inside Seat Width 20 ¹ / ₂ Inside Seat Depth 18 Arm Height 24 ³ / ₄ 1 ¹ / ₂ yds. 29 lbs. TB 133, add \$72 List	Wood	1002	1088	1108	1144	1180	1215	1251	1284	1321	1486	1607	1725
		Urethane	1002	1088	1108	1144	1180	1215	1251	1284	1321	1486	1607	1725
		Corian	1180	1266	1286	1322	1358	1393	1429	1462	1499	1664	1785	1903
4410-2-W (WOOD ARM CAPS) 4410-2-U (URETHANE ARM CAPS) 4410-2-CO (CORIAN ARM CAPS) 	Two-Seat Tandem W 46 ¹ / ₂ D 26 ¹ / ₂ H 34 Seat Height 18 Inside Seat Width 20 ¹ / ₂ Inside Seat Depth 18 Arm Height 24 ³ / ₄ 3 yds. 58 lbs. TB 133, add \$144 List	Wood	1783	1954	1995	2067	2139	2209	2281	2347	2420	2751	2993	3229
		Urethane	1783	1954	1995	2067	2139	2209	2281	2347	2420	2751	2993	3229
		Corian	2050	2221	2262	2334	2406	2476	2548	2614	2687	3018	3260	3496
4410-3-W (WOOD ARM CAPS) 4410-3-U (URETHANE ARM CAPS) 4410-3-CO (CORIAN ARM CAPS) 	Three-Seat Tandem W 69 D 26 ¹ / ₂ H 34 Seat Height 18 Inside Seat Width 20 ¹ / ₂ Inside Seat Depth 18 Arm Height 24 ³ / ₄ 4 ¹ / ₂ yds. 87 lbs. TB 133, add \$216 List	Wood	2562	2818	2879	2988	3096	3200	3309	3408	3517	4013	4377	4731
		Urethane	2562	2818	2879	2988	3096	3200	3309	3408	3517	4013	4377	4731
		Corian	2918	3174	3235	3344	3452	3556	3665	3764	3873	4369	4733	5087
4410-4-W (WOOD ARM CAPS) 4410-4-U (URETHANE ARM CAPS) 4410-4-CO (CORIAN ARM CAPS) 	Four-Seat Tandem W 91 ¹ / ₂ D 26 ¹ / ₂ H 34 Seat Height 18 Inside Seat Width 20 ¹ / ₂ Inside Seat Depth 18 Arm Height 24 ³ / ₄ 6 yds. 116 lbs. TB 133, add \$288 List	Wood	3419	3760	3842	3986	4131	4270	4415	4547	4692	5354	5839	6311
		Urethane	3419	3760	3842	3986	4131	4270	4415	4547	4692	5354	5839	6311
		Corian	3864	4205	4287	4431	4576	4715	4860	4992	5137	5799	6284	6756

OPTIONS (XXXX - REFERS TO CHAIR MODEL NUMBER)

MODEL	DESCRIPTION	LIST
XXXX-MB01	Moisture Barrier (seat only, per seat)	50
XXXX-SC01	Replaceable Seat Cover Feature (per seat)	45
XXXX-NS07B	Non-Skid Glides (per arm frame)	10
XXXX-PF01	Premium Finish (per arm frame)	55

Q S = Available on Quick-Ship Program (standard finishes only).

NOTES:

- Bariatric models feature 750 lbs. maximum seat capacity.
- Wood arm caps available in Beech, Walnut and White Oak.
- For Corian arm caps, a wood species and finish must be specified for the lower portion of the arm cap.
- Please specify option code after model number and add upcharges accordingly.
- Refer to page 15 for two-tone upholstery examples and yardage requirements.

SPECIFY:

1. Model number
2. Upper arm cap finish
3. Lower arm cap finish, as applicable
4. Frame finish
5. Upholstery selection
6. Options, as applicable

ORDERING EXAMPLE:

#4440-W-NS07B
 34" Wide Bariatric Chair
 Wood Arm Caps
 Non-Skid Glides

**SOLEIL
 GUEST-TANDEM**

designed by david dahl



SIN #711-17

MODEL NUMBER	PRODUCT SPECIFICATIONS	ARM CAPS	FABRIC GRADES							LEATHER GRADES				
			COM	1	2	COL			3	4	5	6	7	8
4440-W (WOOD ARM CAPS) 4440-U (URETHANE ARM CAPS) 4440-CO (CORIAN ARM CAPS)	Bariatric Settee, 34" Wide W 34 D 26 ¹ / ₂ H 34 Seat Height 18 Inside Seat Width 30 Inside Seat Depth 18 Arm Height 24 ³ / ₄ 2 ¹ / ₂ yds. 40 lbs. TB 133, add \$120 List	Wood	1344	1486	1520	1581	1641	1699	1759	1814	1875	2150	2352	2549
		Urethane	1344	1486	1520	1581	1641	1699	1759	1814	1875	2150	2352	2549
		Corian	1522	1664	1698	1759	1819	1877	1937	1992	2053	2328	2530	2727
4445-W (WOOD ARM CAPS) 4445-U (URETHANE ARM CAPS) 4445-CO (CORIAN ARM CAPS)	Bariatric Settee, 40" Wide W 40 D 26 ¹ / ₂ H 34 Seat Height 18 Inside Seat Width 36 Inside Seat Depth 18 Arm Height 24 ³ / ₄ 2 ³ / ₄ yds. 44 lbs. TB 133, add \$132 List	Wood	1538	1694	1732	1798	1865	1928	1995	2055	2122	2425	2647	2864
		Urethane	1538	1694	1732	1798	1865	1928	1995	2055	2122	2425	2647	2864
		Corian	1716	1872	1910	1976	2043	2106	2173	2233	2300	2603	2825	3042

OPTIONS (XXXX - REFERS TO CHAIR MODEL NUMBER)

MODEL	DESCRIPTION	LIST
XXXX-MB02	Moisture Barrier, Seat Only	95
XXXX-SC02	Replaceable Seat Cover Feature	60
XXXX-NS07B	Non-Skid Glides	20
XXXX-PF02	Premium Finish	80

SOLEIL GUEST-TANDEM

designed by david dahl



NOTES:

- Wood arm caps available in Beech, Walnut and White Oak.
- For Corian arm caps, a wood species and finish must be specified for the lower portion of the arm cap.
- Easy access/hip chair features Brushed Stainless Steel foot step, positioned 6¹/₂" from the floor.
- Please specify option code after model number and add upcharges accordingly.
- Refer to page 15 for two-tone upholstery examples and yardage requirements.

SPECIFY:

1. Model number
2. Upper arm cap finish
3. Lower arm cap finish, as applicable
4. Frame finish
5. Upholstery selection
6. Options, as applicable

ORDERING EXAMPLE:

#4450-CO-PF02

Patient Chair
Corian Arm Caps
Premium Finish

SIN #711-17

MODEL NUMBER	PRODUCT SPECIFICATIONS	FABRIC GRADES										LEATHER GRADES		
		ARM CAPS	COL	1	2	3	4	5	6	7	8	L1	L2	L3
4450-W (WOOD ARM CAPS) 4450-U (URETHANE ARM CAPS) 4450-CO (CORIAN ARM CAPS)	Patient Chair W 24 ¹ / ₂ D 26 ¹ / ₂ H 42 ¹ / ₂ Seat Height 18 Inside Seat Width 20 ¹ / ₂ Inside Seat Depth 18 Arm Height 24 ³ / ₄ 1 ³ / ₄ yds. 31 lbs. TB 133, add \$84 List	Wood	1133	1233	1257	1299	1341	1382	1424	1462	1505	1698	1839	1977
		Urethane	1133	1233	1257	1299	1341	1382	1424	1462	1505	1698	1839	1977
		Corian	1311	1411	1435	1477	1519	1560	1602	1640	1683	1876	2017	2155
4457-W (WOOD ARM CAPS) 4457-U (URETHANE ARM CAPS) 4457-CO (CORIAN ARM CAPS)	Easy Access/Hip Chair W 24 ¹ / ₂ D 26 ¹ / ₂ H 41 ¹ / ₂ Seat Height 25 Inside Seat Width 20 ¹ / ₂ Inside Seat Depth 18 Arm Height 32 ¹ / ₄ 1 ¹ / ₂ yds. 42 lbs. TB 133, add \$72 List	Wood	1397	1483	1503	1539	1575	1610	1646	1679	1716	1881	2002	2120
		Urethane	1397	1483	1503	1539	1575	1610	1646	1679	1716	1881	2002	2120
		Corian	1575	1661	1681	1717	1753	1788	1824	1857	1894	2059	2180	2298

OPTIONS (XXXX - REFERS TO CHAIR MODEL NUMBER)

MODEL	DESCRIPTION	LIST
XXXX-MB01	Moisture Barrier, Seat Only	50
XXXX-SC01	Replaceable Seat Cover Feature	45
XXXX-NS07B	Non-Skid Glides	20
XXXX-PF02	Premium Finish	80

NOTES:

- To build tandem configurations, always specify units from left-to-right, as facing.
- Seats, together with backs, are specified individually, as are arm frame units.
- Please specify option code after model number and add upcharges accordingly.
- Refer to page 15 for two-tone upholstery examples and yardage requirements.
- **Please include seating/table layout drawings or sketch with each order.**

SPECIFY:

1. Model number
2. Upholstery selection
3. Options, as applicable

ORDERING EXAMPLE:

#4430-SC02
30" Wide Seat & Back
Replaceable Seat Cover

**SOLEIL
GUEST-TANDEM**

designed by david dahl

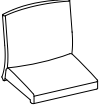
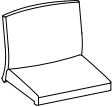
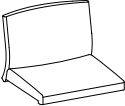

SIN #711-17

MODEL NUMBER	PRODUCT SPECIFICATIONS	FABRIC GRADES							LEATHER GRADES				
FOR TANDEM CONFIGURATIONS ONLY		COM	1	2	COL			7	8	L1	L2	L3	
					3	4	5	6					
4420 	20¹/₂" Wide Seat & Back 1 ¹ / ₂ yds. 16 lbs. TB 133, add \$69 List	578	664	684	720	756	791	827	860	897	1062	1183	1301
4430 	30" Wide Seat & Back 2 ¹ / ₂ yds. 23 lbs. TB 133, add \$115 List	918	1060	1094	1155	1215	1273	1333	1388	1449	1724	1926	2123
4436 	36" Wide Seat & Back 2 ³ / ₄ yds. 26 lbs. TB 133, add \$127 List	1111	1267	1305	1371	1438	1501	1568	1628	1695	1998	2220	2437
	Arm Frames Page 8 Connecting Tables Page 9												

OPTIONS (XXXX - REFERS TO COMPONENT MODEL NUMBER)

MODEL	DESCRIPTION	LIST
XXXX-MB01	Moisture Barrier, 20 ¹ / ₂ " Wide (seat only)	50
XXXX-MB02	Moisture Barrier, 30" and 36" Wide (seat only)	95
XXXX-SC01	Replaceable Seat Cover Feature, 20 ¹ / ₂ " Wide	45
XXXX-SC02	Replaceable Seat Cover Feature, 30" and 36" Wide	60

SOLEIL GUEST-TANDEM

designed by david dahl



NOTES:

- To build tandem configurations, always specify units from left-to-right, as facing.
- Seats, together with backs, are specified individually, as are arm frame units.
- Wood arm caps available in Beech, Walnut and White Oak.
- For Corian arm caps, a wood species and finish must be specified for the lower portion of the arm cap.
- Please specify option code after model number and add upcharges accordingly.
- **Please include seating/table layout drawings or sketch with each order.**

SPECIFY:

1. Model number
2. Upper arm cap finish
3. Lower arm cap finish, as applicable
4. Frame finish
5. Options, as applicable

ORDERING EXAMPLE:

#4400-L-W-NS07A

Metal Arm, Left
Wood Arm Cap
Non-Skid Glides

SIN #711-17

MODEL NUMBER

PRODUCT SPECIFICATIONS

FOR TANDEM CONFIGURATIONS ONLY

4400-R-W (WOOD ARM CAP) Metal Arm with Arm Cap Right (as facing)
4400-R-U (URETHANE ARM CAP) 7 lbs.
4400-R-CO (CORIAN ARM CAP)

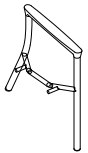

ARM CAP	LIST
Wood	214
Urethane	214
Corian	303

4400-L-W (WOOD ARM CAP) Metal Arm with Arm Cap Left (as facing)
4400-L-U (URETHANE ARM CAP) 7 lbs.
4400-L-CO (CORIAN ARM CAP)



Wood	214
Urethane	214
Corian	303

4400-C-W (WOOD ARM CAP) Metal Arm with Arm Cap, Center
4400-C-U (URETHANE ARM CAP) 8 lbs.
4400-C-CO (CORIAN ARM CAP)

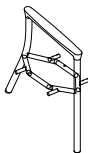

Wood	231
Urethane	231
Corian	320

Seats & Backs Models Page 7
 Connecting Tables Page 9

OPTIONS (XXXX - REFERS TO COMPONENT MODEL NUMBER)

MODEL	DESCRIPTION	LIST
XXXX-NS07A	Non-Skid Glides (per arm)	10
XXXX-PF01	Premium Finish (per arm)	55

NOTES:

- Connecting tables for configurable modular units only.
- Available in veneer, laminate or Corian.
- Veneer options include Beech, Walnut and White Oak.
- For Corian top, add “-CO” next to model number and specify color. Corian top is affixed to table surface increasing overall table height by 1/2”.
- Table with Corian top, wood edge species and finish selection must be specified.
- **Please include seating/table layout drawings or sketch with each order.**

SPECIFY:

1. Model number
2. Table wood species
3. Table finish
4. Leg finish, as applicable
5. Options, as applicable

ORDERING EXAMPLE:

#4419-90-NS07C
 90-Degree Corner Table
 Non-Skid Glide

**SOLEIL
 GUEST-TANDEM**

designed by david dahl

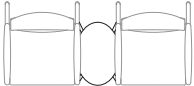
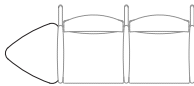
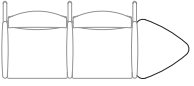
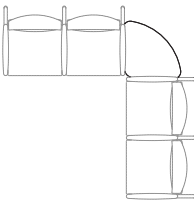

SIN #711-17

MODEL NUMBER	PRODUCT SPECIFICATIONS	TABLE TOP FINISH	
		VENEER OR LAMINATE	CORIAN (-CO)
4417 	Center Table In-Line Add-On W 14 D 20 13 lbs. Field Installed	538	851
4418-L 	End Table, Left (as facing) W 19 D 20 1/2 9 lbs. Field Installed	644	965
4418-R 	End Table, Right (as facing) W 19 D 20 1/2 9 lbs. Field Installed	644	965
4419-90 	90-Degree Corner Table W 22 1/2 D 22 1/2 12 lbs. Field Installed	693	1566

OPTIONS (XXXX - REFERS TO TABLE MODEL NUMBER)

MODEL	DESCRIPTION	LIST
XXXX-NS07C	Non-Skid Glide	5
XXXX-PF01	Premium Finish (per leg)	55

SOLEIL GUEST-TANDEM

designed by david dahl



NOTES:

- Seat and back covers feature concealed velcro attachment.
- Replacement seat and back covers can be easily field installed on previously ordered Soleil models with replaceable cover option.
- Soleil models originally ordered with standard fixed upholstery can utilize replacement seat covers, however some upholstery work will be required to remove original upholstery covers.
- For Corian arm caps, a wood species and finish must be specified for the lower portion of the arm cap.
- Replacement hardware included with replacement arm frames and/or arm caps.







SPECIFY:

1. Model number
2. Upholstery selection, as applicable
3. Arm cap finish, as applicable

ORDERING EXAMPLE:

#44-W
Replacement Wood Arm Cap

SIN #711-17

MODEL NUMBER	PRODUCT SPECIFICATIONS	FABRIC GRADES							LEATHER GRADES				
		COM	1	2	COL 3	4	5	6	7	8	L1	L2	L3
SSC-4410 	Replacement Upholstered Seat Cover Only 3/4 yd. TB 133, add \$36 List Applies to: 4410 Guest 4420 Tandem 4450 Patient Chair 4457 Hip Chair	101	144	154	172	190	208	226	242	261	343	404	463
SSC-4440 	34" Wide Bariatric Settee Replacement Upholstered Seat Cover Only 1 yd. TB 133, add \$48 List	159	216	230	254	278	301	325	347	372	482	563	641
SSC-4445 	40" Wide Bariatric Settee Replacement Upholstered Seat Cover Only 1 1/4 yds. TB 133, add \$60 List	159	230	247	278	308	337	367	394	425	562	663	762
44-W (WOOD) 	Replacement Arm Cap, Wood 2 lbs.	107											
44-U (URETHANE) 	Replacement Arm Cap, Black Urethane 2 lbs.	107											
44-CO (CORIAN) 	Replacement Arm Cap, Corian (standard colors only) 2 lbs.	186											

NOTES:

- Replacement hardware included with replacement arm frames.
- Please specify option code after model number and add upcharges accordingly.

SPECIFY:

1. Model number
2. Frame/leg finish
3. Options, as applicable

ORDERING EXAMPLE:

#SA-4410-C-PF01





Replacement Guest Chair
Arm Frame
Premium Finish

SOLEIL
GUEST-TANDEM

designed by david dahl

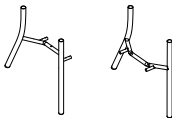

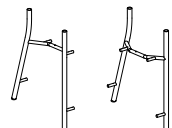
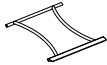
SIN #711-17

MODEL NUMBER		LIST
<p>SA-4410-R (RIGHT ARM, AS SEATED) SA-4410-L (LEFT ARM, AS SEATED)</p> 	<p>Replacement Guest Chair Arm Frame (Arm Cap Not Included) 5 lbs.</p>	185
<p>SA-4410-C (CENTER ARM)</p> 	<p>Replacement Guest Chair Arm Frame (Arm Cap Not Included) 6 lbs.</p>	202
<p>SA-4457-R (RIGHT ARM, AS SEATED) SA-4457-L (LEFT ARM, AS SEATED)</p> 	<p>Replacement Easy Access/Hip Chair Arm Frame (Arm Cap Not Included) 6.5 lbs.</p>	197
<p>SA-4457-FR</p> 	<p>Replacement Easy Access/Hip Chair Foot Rest 7 lbs.</p>	218
<p>SL-4418-R SL-4418-L</p> 	<p>Replacement End Table Leg, Right (as seated) Replacement End Table Leg, Left (as seated) 5 lbs.</p>	185

OPTIONS (XXXX - REFERS TO COMPONENT MODEL NUMBER)

MODEL	DESCRIPTION	LIST
XXXX-NS07A	Non-Skid Glides (per arm frame)	10
XXXX-PF01	Premium Finish (per arm frame)	55

SOLEIL GUEST-TANDEM

designed by david dahl



NOTES:

- Complete seat component includes frame, foam and upholstery cover.

SPECIFY:



- Model number
- Upholstery selection
- Options, as applicable

ORDERING EXAMPLE:

#SST-4410-MB01

Replacement Seat Frame, Foam & Upholstery Cover
Moisture Barrier

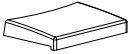
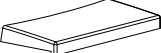
SIN #711-17

MODEL NUMBER	PRODUCT SPECIFICATIONS	FABRIC GRADES							LEATHER GRADES				
		COM	1	2	COL 3	4	5	6	7	8	L1	L2	L3
SST-4410 	Replacement Seat Frame, Foam & Upholstery Cover 3/4 yd. 7 lbs. TB 133, add \$36 List Applies to: 4410 Guest 4420 Tandem 4450 Patient Chair 4457 Easy Access/Hip Chair	258	301	311	329	347	365	383	399	418	500	561	620
SST-4440 	34" Wide Bariatric Settee, Replacement Seat Frame, Foam & Upholstery Cover 1 1/2 yds. 10 lbs. TB 133, add \$48 List	430	487	501	525	549	572	596	618	643	753	834	912
SST-4445 	40" Wide Bariatric Settee, Replacement Seat Frame, Foam & Upholstery Cover 1 1/2 yds. 12 lbs. TB 133, add \$60 List	524	595	612	643	673	702	732	759	790	927	1028	1127

OPTIONS (XXXX - REFERS TO COMPONENT MODEL NUMBER)

MODEL	DESCRIPTION	LIST
XXXX-MB01	Moisture Barrier, 20 1/2" Wide (seat only)	50
XXXX-MB02	Moisture Barrier, 30" and 36" Wide (seat only)	95
XXXX-SC01	Replaceable Seat Cover Feature, 20 1/2" Wide	45
XXXX-SC02	Replaceable Seat Cover Feature, 30" and 36" Wide	60

NOTES:

- Complete back component includes frame, foam and upholstery cover.
- Replacement hardware included.

SPECIFY:

1. Model number
2. Upholstery selection

ORDERING EXAMPLE:

#**SBK-4410**



Replacement Back Frame,
Foam and Upholstery Cover

**SOLEIL
GUEST-TANDEM**

designed by david dahl

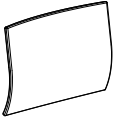
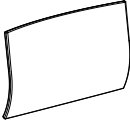

SIN #711-17

MODEL NUMBER	PRODUCT SPECIFICATIONS	FABRIC GRADES								LEATHER GRADES						
		COM	1	2	COL			4	5	6	7	8	L1	L2	L3	
SBK-4410 	Replacement Back Frame, Foam & Upholstery Cover 3/4 yd. 9 lbs. TB 133, add \$36 List	280	323	333	351	369	387	405	421	440	522	583	642			
SBK-4440 	34" Wide Bariatric Settee, Replacement Back Frame, Foam & Upholstery Cover 1 1/2 yds. 13 lbs. TB 133, add \$72 List	453	539	559	595	631	666	702	735	772	937	1058	1176			
SBK-4445 	40" Wide Bariatric Settee, Replacement Back Frame, Foam & Upholstery Cover 1 1/2 yds. 18 lbs. TB 133, add \$72 List	545	631	651	687	723	758	794	827	864	1029	1150	1268			
SBK-4450 	Patient Chair, Replacement Back Frame, Foam & Upholstery Cover 1 yd. 9 lbs. TB 133, add \$48 List	429	486	500	524	548	571	595	617	642	752	833	911			

SOLEIL GUEST-TANDEM

designed by david dahl



SIN #711-17

CONFIGURATION AND ORDERING EXAMPLES

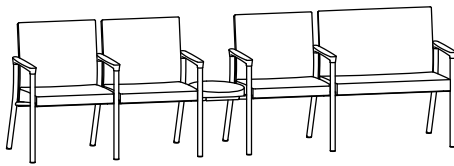

Qty	Model #	Description	COM List
3	4420	20 ¹ / ₂ " Wide Seat & Back (\$578 List each)	1,734
1	4430	30" Wide Seat & Back	918
1	4400-L-W	Metal Arm, Left (as facing), Wood Arm Cap	214
1	4400-R-W	Metal Arm, Right (as facing), Wood Arm Cap	214
4	4400-C-W	Metal Arm, Center, Wood Arm Cap (\$231 List each)	924
1	4417	Center Table	538
11			4,542

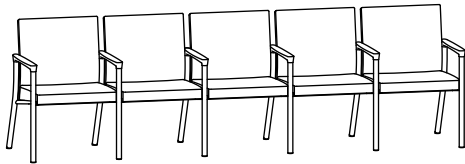

Qty	Model #	Description	COM List
5	4420	20 ¹ / ₂ " Wide Seat & Back (\$578 List each)	2,890
1	4400-L-W	Metal Arm, Left (as facing), Wood Arm Cap	214
1	4400-R-W	Metal Arm, Right (as facing), Wood Arm Cap	214
4	4400-C-W	Metal Arm, Center, Wood Arm Cap (\$231 List each)	924
11			4,242

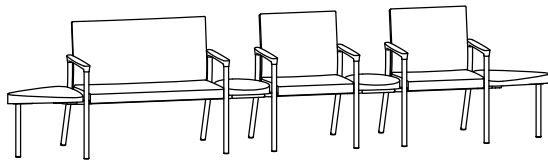

Qty	Model #	Description	COM List
1	4436	36" Wide Seat & Back	1,111
2	4420	20 ¹ / ₂ " Wide Seat & Back (\$578 List each)	1,156
6	4400-C-CO	Metal Arm, Center, Corian Arm Cap (\$320 List each)	1,920
1	4418-L-CO	End Table, Left, Corian Top	965
2	4417-CO	Center Table, Corian Top (\$851 List each)	1,702
1	4418-R-CO	End Table, Right, Corian Top	965
13			7,819

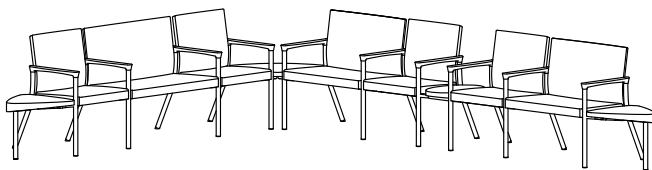

Qty	Model #	Description	COM List
4	4420	20 ¹ / ₂ " Wide Seat & Back (\$578 List each)	2,312
2	4430	30" Wide Seat & Back (\$918 List each)	1,836
1	4436	36" Wide Seat & Back	1,111
10	4400-C-U	Metal Arm, Center, Black Urethane Arm Cap (\$231 List each)	2,310
1	4418-L	End Table, Left, Wood Top	644
1	4419-90	90-Degree Table, Wood Top	693
1	4417	Center Table, Wood Top	538
1	4418-R	End Table, Right, Wood Top	644
21			10,088

UPHOLSTERY COMBINATIONS:

For fabric, vinyl or leather upholstery combinations, refer to the pricing below:

- When combining **two** COM/COV/COL fabrics, or fabrics with the same grade, add the following (per unit):
 - › \$45 List for guest, patient and hip chairs
 - › \$65 List for bariatric chairs
- When combining **three or more** COM/COV/COL fabrics, or fabrics with the same grade, add the following (per unit):
 - › \$55 List for guest, patient and hip chairs
 - › \$75 List for bariatric chairs
- When combining different grades of fabric, price will be based on the highest grade specified.
- Two-tone upholstery examples and yardage requirements for the most common combinations are listed below. Additional combinations available, please contact Customer Service for yardage requirements and pricing.
- Note: Yardage amounts are based on fabric which is plain (i.e. non-directional) and a full 54" wide.
- **Appropriate upholstery code must be included on order.**

SOLEIL GUEST-TANDEM

designed by david dahl



SIN #711-17



Code **SH1**

Models COM Requirement
 All Guest Seat = 3/4 yd.
 & Hip Chair Back = 3/4 yd.
 Units



Code **SH2**

Models COM Requirement
 All 34" W Seat = 1 yd.
 Bariatric Back = 1 1/2 yds.
 Units

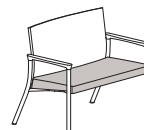

Code **SH3**

Models COM Requirement
 All 40" W Seat = 1 yd.
 Bariatric Back = 1 1/2 yds.
 Units



Code **SH4**

Models COM Requirement
 4450 Seat = 3/4 yd.
 Back = 1 yd.



SOLEIL LOUNGE

designed by david dahl



SIN #711-16

PRODUCT FEATURES:

- Metal frame available in standard and premium finishes. See below for options.
- For premium metal finishes, please refer to individual pages for applicable upcharge.
- Three arm cap options: wood, black urethane and Corian.
- Wood arm caps available in Beech, Walnut and White Oak.
- All standard and custom wood finishes available.
- For custom wood finishes, please add one-time upcharge of \$400 List per color per order.
- Corian arm caps available in four standard colors. For non-standard colors, please contact Customer Service for pricing.
- For Corian arm caps, a wood species and finish must be specified for the arm cap lower portion.
- Non-skid glides available for hard surface floors. Refer to individual pages for specification information and pricing.
- 350 lbs. maximum weight capacity.
- Please refer to page 5 for two-tone upholstery examples, yardage requirements and pricing.
- All dimensions are nominal.

METAL FINISH COLORS:

#06 Charcoal Grey
#90 Metallic Silver

PREMIUM FINISH COLORS:

#07 Gold Shimmer
#08 Penny
#09 Brown Sugar
#83 Metallic Champagne
#94 Cotton

CORIAN® COLORS:

Designer White
Linen
Rain Cloud
Witch Hazel

Corian® is a registered trademark of Dupont.

SOLEIL LOUNGE

designed by david dahl

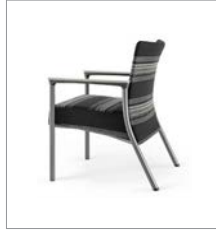

SIN #711-16

SPECIAL FEATURES:



- Arm cap features radiused edges for smooth surface contact.
- All styles field-replaceable.



- Passive flex back motion provides long-term seated comfort.



- Clean-outs on every side, including between the seat and back.
- Enables crumbs and debris to fall through for maintenance ease.



- Metal seat frame construction ensures durability and allows in-field component replacement.

- Wall-saver leg design.
- Optional replaceable seat upholstery.
- Replacement seat covers can be easily field installed on previously ordered Soleil models with standard fixed upholstery. Contact Customer Service for instructions.
- For the complete list of replaceable components, please refer to page 4.

NOTES:

- Wood arm caps available in Beech, Walnut and White Oak.
- For Corian arm caps, a wood species and finish must be specified for the lower portion of the arm cap.
- Please specify option code after model number and add upcharges accordingly.
- Refer to page 5 for two-tone upholstery examples and yardage requirements.

SPECIFY:

1. Model number
2. Upper arm cap finish
3. Lower arm cap finish, as applicable
4. Frame finish
5. Upholstery selection
6. Options, as applicable

ORDERING EXAMPLE:

#4461-U-PF02



Lounge Chair
Black Urethane Arms
Premium Metal Finish

**SOLEIL
LOUNGE**

designed by david dahl



SIN #711-16

MODEL NUMBER	PRODUCT SPECIFICATIONS	FABRIC GRADES								LEATHER GRADES			
		COM	1	2	COL			7	8	L1	L2	L3	
4461-W 	Lounge Chair, Wood Arm Caps W 26 ¹ / ₂ D 26 H 32 ¹ / ₂ Seat Height 17 ¹ / ₂ Inside Seat Width 22 ¹ / ₂ Inside Seat Depth 18 ¹ / ₂ Arm Height 24 1 ¹ / ₂ yds. 35 lbs. TB 133, add \$72 List	1563	1649	1669	1705	1741	1776	1812	1845	1882	2047	2168	2286
4461-U 	Lounge Chair, Black Urethane Arm Caps W 26 ¹ / ₂ D 26 H 32 ¹ / ₂ Seat Height 17 ¹ / ₂ Inside Seat Width 22 ¹ / ₂ Inside Seat Depth 18 ¹ / ₂ Arm Height 24 1 ¹ / ₂ yds. 35 lbs. TB 133, add \$72 List	1563	1649	1669	1705	1741	1776	1812	1845	1882	2047	2168	2286
4461-CO 	Lounge Chair, Corian Arm Caps W 26 ¹ / ₂ D 26 H 32 ¹ / ₂ Seat Height 17 ¹ / ₂ Inside Seat Width 22 ¹ / ₂ Inside Seat Depth 18 ¹ / ₂ Arm Height 24 1 ¹ / ₂ yds. 35 lbs. TB 133, add \$72 List	1731	1817	1837	1873	1909	1944	1980	2013	2050	2215	2336	2454

OPTIONS (XXXX - REFERS TO CHAIR MODEL NUMBER)

MODEL	DESCRIPTION	LIST
XXXX-MB02	Moisture Barrier, Seat Only	95
XXXX-SC02	Replaceable Seat Cover Feature	60
XXXX-NS07B	Non-Skid Glides	20
XXXX-PF02	Premium Finish	80

SOLEIL LOUNGE

designed by david dahl



NOTES:

- Seat and back covers feature concealed velcro attachment.
- Replacement seat and back covers can be easily field installed on previously ordered Soleil models with replaceable cover option.
- Soleil models originally ordered with standard fixed upholstery can utilize replacement seat and/or back covers, however some upholstery work will be required to remove original upholstery covers.
- For Corian arm caps, a wood species and finish must be specified for the lower portion of the arm cap.



SPECIFY:





1. Model number
2. Upholstered selection, as applicable
3. Frame finish, as applicable
4. Arm cap finish, as applicable

ORDERING EXAMPLE:

#SST-4461-MB02
Replacement Seat Frame
Moisture Barrier

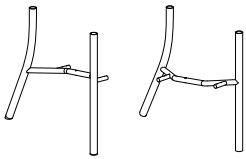
SIN #711-16

MODEL NUMBER	PRODUCT SPECIFICATIONS	FABRIC GRADES							LEATHER GRADES				
		COM	1	2	COL			8	L1	L2	L3		
SSC-4461 	Lounge Chair Replacement Upholstered Seat Cover Only 3/4 yd. TB 133, add \$36 List	164	207	217	235	253	271	289	305	324	406	467	526
SST-4461 	Lounge Chair Replacement Seat Frame, Foam and Upholstery Cover 3/4 yd. 9 lbs. TB 133, add \$36 List	430	473	483	501	519	537	555	571	590	672	733	792
SBK-4461 	Lounge Chair Replacement Back Frame, Foam and Upholstery Cover 3/4 yd. 11 lbs. TB 133, add \$36 List	519	562	572	590	608	626	644	660	679	761	822	881

MODEL NUMBER	DESCRIPTION	LIST
SA-4461-R (RIGHT ARM, AS SEATED) SA-4461-L (LEFT ARM, AS SEATED) 	Replacement Lounge Chair Arm Frame, No Arm Cap 9 lbs.	185
44-W (WOOD) 	Replacement Lounge Arm Cap, Wood 2 lbs.	107
44-U (URETHANE) 	Replacement Lounge Arm Cap, Black Urethane 2 lbs.	107
44-CO (CORIAN) 	Replacement Lounge Arm Cap, Corian (standard colors only) 2 lbs.	186

MODEL	DESCRIPTION	LIST
XXXX-MB02	Moisture Barrier, Complete Seat Only	95
XXXX-SC02	Replaceable Seat Cover Feature	60
XXXX-NS07A	Non-Skid Glides (per arm frame)	10
XXXX-PF01	Premium Finish (per arm frame)	55

UPHOLSTERY COMBINATIONS:

For fabric, vinyl or leather upholstery combinations, refer to the pricing below:

- When combining **two** COM/COV/COL fabrics, or fabrics with the same grade, add \$65 List per unit.
- When combining **three or more** COM/COV/COL fabrics, or fabrics with the same grade, add \$75 List per unit.
- When combining different grades of fabric, price will be based on the highest grade specified.
- Two-tone upholstery examples and yardage requirements for the most common combinations are listed below. Additional combinations available, please contact Customer Service for yardage requirements and pricing.
- Note: Yardage amounts are based on fabric which is plain (i.e. non-directional) and a full 54" wide.
- **Appropriate upholstery code must be included on order.**

SOLEIL LOUNGE

designed by david dahl



SIN #711-16

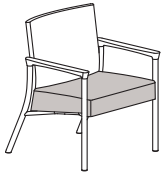

Code	SH15
<u>Models</u>	<u>COM Requirement</u>
4461	Seat = $\frac{3}{4}$ yd. Back = $\frac{3}{4}$ yd.

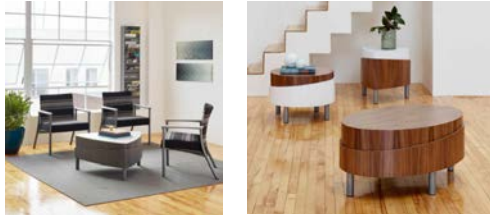

SOLEIL OCCASIONAL TABLES

designed by david dahl

SIN #711-11

PRODUCT FEATURES:

- Tables available in Beech, Walnut and White Oak veneer as well as laminate and Corian.
- Corian top is affixed to table surface increasing overall table height by $\frac{1}{2}$ ". Please note that a $\frac{1}{8}$ " reveal will be present.
- **Table with Corian top, wood body species and finish selection must be specified.**
- All standard and custom wood finishes available.
- For custom wood finishes, please add \$400 List per color per order.
- When ordering in laminate, specify laminate manufacturer, color and pattern number.
- If standard laminate is specified, no upcharge.
- For custom laminates, add \$500 List per color per order. Pre-approval required, please contact Customer Service.
- Two-tone finishing (top and bottom tier) available at no upcharge.
- Metal legs available in standard and premium finishes.
- Beech wood legs also available, specify "-WL01" after model number with finish selection and add \$110 List per unit.
- Non-skid glides available for hard surface floors.
- All dimensions are nominal.

METAL FINISH COLORS:

#06 Charcoal Grey

#90 Metallic Silver

PREMIUM FINISH COLORS:

#07 Gold Shimmer

#83 Metallic Champagne

#08 Penny

#94 Cotton

#09 Brown Sugar

CORIAN® COLORS:

Designer White

Linen

Rain Cloud

Witch Hazel

Corian® is a registered trademark of Dupont.

SOLEIL OCCASIONAL TABLES

designed by david dahl



NOTES:

- Tables available in Beech, Walnut and White Oak veneer as well as laminate and Corian.
- Corian top is affixed to table surface increasing overall table height by 1/2" and features 1/8" reveal.
- **Table with Corian top, wood body species and finish selection must be specified.**
- Metal legs available in standard and premium finishes.
- Two-tone finishing (top and bottom tier) available at no upcharge.

SPECIFY:

1. Model number
2. Table wood species
3. Table finish
4. Leg finish
5. Options, as applicable

ORDERING EXAMPLE:

#442-202016-CO-NS07B

Triangle Table
20" x 20" x 16"
Corian Top
Non-Skid Glides

SIN #711-11

MODEL NUMBER		PRODUCT SPECIFICATIONS			
		MODEL NUMBER	VENEER OR LAMINATE	CORIAN (-CO)	WEIGHT
440 	Round Table				
	18" Dia. x 16" H	440-1816	1192	1602	23
	18" Dia. x 20" H	440-1820	1271	1682	25
	24" Dia. x 16" H	440-2416	1411	2130	36
	36" Dia. x 16" H	440-3616	2008	3617	60
442 	Triangle Table				
	20" W x 20" L x 16" H	442-202016	1271	1775	25
	20" W x 20" L x 20" H	442-202020	1360	1865	27
	33" W x 33" L x 16" H	442-333316	1843	3198	66
447 	Ellipse Table				
	28" W x 20" L x 16" H	447-282016	1488	2191	32
	36" W x 24" L x 16" H	447-362416	1693	2770	47

OPTIONS (XXXX - REFERS TO TABLE MODEL NUMBER)

MODEL	DESCRIPTION	LIST
XXXX-WL01	Wood Legs	110
XXXX-NS07B	Non-Skid Glides	20
XXXX-PF01	Premium Leg Finish	55

SPOT MOBILE BENCHES

designed by david dahl

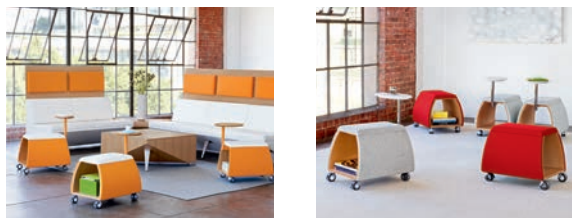

SIN #711-16

PRODUCT FEATURES:

- Available in Beech, Walnut and White Oak, in all standard and custom wood finishes.
- Laminates also offered, please specify.
- Non-locking casters feature semi-soft treads for compatibility on all floor surfaces.
- Tablet size is $15\frac{1}{2}$ " W x $12\frac{1}{2}$ " D x $\frac{3}{4}$ " thick with 360-degree turning radius.
- Three tablet surface options: veneer (Beech, Walnut and White Oak), laminate or Corian.
- For custom wood finishes (to bench and/or tablet), please add one-time upcharge of \$400 List per color per order.
- For standard laminates (to bench and/or tablet), refer to Standard Finish Card.
- For custom laminates (to bench and/or tablet), add \$500 List per color per order. Pre-approval required, please contact Customer Service.
- Corian available in four standard colors. For non-standard options, please contact Customer Service for pricing.
- Tablet mounting post available in #06 Charcoal Grey, #83 Metallic Champagne, #90 Metallic Silver, #91 Chrome and #95 Satin Black, please specify.
- For premium tablet mounting post finishes, please add \$55 List per unit and specify color. Refer to options below.
- Maximum weight capacity is 350 lbs.
- Two-tone upholstery examples and yardage requirements featured on page 3.
- All dimensions are nominal.

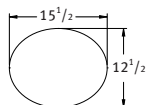

Rotating Tablet Shape

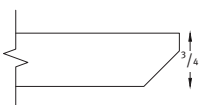

Veneer/Laminate Top - Edge Profile

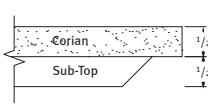

Corian Top - Edge Profile

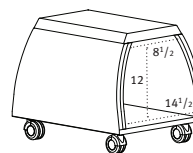

Inside Clearance

CORIAN® COLORS:

Designer White
Linen
Rain Cloud
Witch Hazel

PREMIUM TABLET POST FINISH OPTIONS:

#07 Gold Shimmer #83 Metallic Champagne
#08 Penny #94 Cotton
#09 Brown Sugar

Corian® is a registered trademark of Dupont.

EDGE FINISH SPECIFICATIONS (BENCH AND TABLET):

- For veneer tops, edge finish will always match the top finish color, unless otherwise specified.
- For standard laminate tops (laminate cannot be applied to the edge):
 - Wood grain laminates, edge finish will match the laminate top color, unless otherwise specified.
 - Solid color laminates, edge finish will be natural (clear coat) as standard, unless otherwise specified.
- For Corian tops:
 - Designer White, Rain Cloud and Linen colors, edge will be white as standard, unless otherwise specified.
 - Witch Hazel, edge will be natural (clear coat) as standard, unless otherwise specified.
- Edges are also available in all standard wood finishes, please specify. For custom edge finishes, please add one-time upcharge of \$400 List per color, per order.

SPOT MOBILE BENCHES

designed by david dahl



SIN #711-16

NOTES:

- Available in Beech, Walnut and White Oak, in all standard and custom wood finishes.
- Laminates also offered, please specify. Edge finish will follow tablet edge finish specification.
- Non-locking casters feature semi-soft treads for compatibility on all floor surfaces.
- Three tablet surface options: veneer (Beech, Walnut and White Oak), laminate or Corian.
- Two-tone upholstery examples and yardage requirements featured on page 3.



SPECIFY:

1. Model number
2. Wood species
3. Wood finish
4. Upholstery selection
5. Tablet finish, as applicable
6. Tablet post finish, as applicable

ORDERING EXAMPLE:

#2110-TAC05-PF01

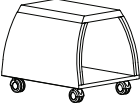
Mobile Bench
Premium Tablet Post Finish

MODEL NUMBER	PRODUCT SPECIFICATIONS	WOOD SPECIES	FABRIC GRADES							LEATHER GRADES				
			COM	1	2	COL			3	4	5	6	7	8
2110 	Mobile Bench W 17 ¹ / ₂ D 22 ¹ / ₂ H 17 ¹ / ₂ Seat Width 11 ¹ / ₂ Seat Depth 17 ¹ / ₂ 1 ¹ / ₄ Yds. 21 lbs. COL 25 Sq. Ft. TB 133, add \$60 List	Beech	760	831	848	879	909	938	968	995	1026	1163	1264	1363
		Walnut, White Oak and Laminate	914	985	1002	1033	1063	1092	1122	1149	1180	1317	1418	1517
2110-TAC05 	Mobile Bench with Veneer or Laminate Tablet W 17 ¹ / ₂ D 22 ¹ / ₂ H 26 Seat Height 17 ¹ / ₂ Seat Width 11 ¹ / ₂ Seat Depth 17 ¹ / ₂ 1 ¹ / ₄ Yds. 26 lbs. COL 25 Sq. Ft. TB 133, add \$60 List	Beech	1051	1122	1139	1170	1200	1229	1259	1286	1317	1454	1555	1654
		Walnut, White Oak and Laminate	1205	1276	1293	1324	1354	1383	1413	1440	1471	1608	1709	1808
2110-TAC05-CO 	Mobile Bench with Corian Tablet W 17 ¹ / ₂ D 22 ¹ / ₂ H 26 Seat Height 17 ¹ / ₂ Seat Width 11 ¹ / ₂ Seat Depth 17 ¹ / ₂ 1 ¹ / ₄ Yds. 35 lbs. COL 25 Sq. Ft. TB 133, add \$60 List	Beech	1353	1424	1441	1472	1502	1531	1561	1588	1619	1756	1857	1956
		Walnut, White Oak and Laminate	1507	1578	1595	1626	1656	1685	1715	1742	1773	1910	2011	2110

OPTIONS (XXXX - REFERS TO BENCH MODEL NUMBER)

MODEL	DESCRIPTION	LIST
XXXX-PF01	Premium Finish, Tablet Post	55

UPHOLSTERY COMBINATIONS:

For fabric, vinyl or leather upholstery combinations refer to the pricing below:

- When combining **two** COM/COV/COL fabrics or fabrics with the same grade price will be \$65 List (per unit).
 - When combining **three or more** COM/COV/COL fabrics or fabrics with the same grade price will be \$75 List (per unit).
 - When combining different grades of fabric price will be based on the highest grade specified.
- Two-tone upholstery examples and yardage requirements for the most common combinations are listed below. Additional combinations available please contact Customer Service for yardage requirements and pricing.
 - Note: Yardage amounts are based on fabric which is plain (i.e. non-directional) and a full 54" wide.
 - **Appropriate upholstery code must be included on order.**

SPOT MOBILE BENCHES

designed by david dahl



SIN #711-16



Code SP1

Model COM Requirement
 All Top of Seat Only = $\frac{3}{4}$ yd.
 Balance of Bench = $\frac{1}{2}$ yd.

NOTES:

- Models offered with and without back in three heights: 18", 25" and 30".
- Presented in Ash wood, in all standard and custom wood finishes.
- For custom wood finishes (including #01 Pure White), please add one-time upcharge of \$400 List per color per order.
- Seat pad features suspension support for optimum comfort.
- Footring offered in Chrome only and is positioned 5" from the floor for 18" H and 25" H stools, and 10" from the floor for 30" H stools.
- 250 lbs. maximum weight capacity.

SPECIFY:

1. Model number
2. Wood finish
3. Upholstery selection
4. Options, as applicable

ORDERING EXAMPLE:

#3910-30-NS02B

30" Height Stool
Glides

STARKIE STOOLS

designed by christopher panichella

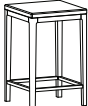
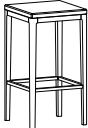

SIN #711-16

MODEL NUMBER	PRODUCT SPECIFICATIONS	FABRIC GRADES										LEATHER GRADES		
		COM	1	2	COL			6	7	8	L1	L2	L3	
3910-18 	18" Height Stool, Backless W 16 ¹ / ₄ D 16 ¹ / ₄ H 18 Seat Height 18 ¹ / ₄ 1/2 yd. 11 lbs. COL 10 Sq. Ft. TB 133, add \$24 List	879	908	915	927	939	950	962	973	986	1041	1081	1120	
3910-25 	25" Height Stool, Backless W 16 ¹ / ₄ D 16 ¹ / ₄ H 25 Seat Height 25 ¹ / ₄ 1/2 yd. 13 lbs. COL 10 Sq. Ft. TB 133, add \$24 List	897	926	933	945	957	968	980	991	1004	1059	1099	1138	
3910-30 	30" Height Stool, Backless W 16 ¹ / ₄ D 16 ¹ / ₄ H 30 Seat Height 30 ¹ / ₄ 1/2 yd. 15 lbs. COL 10 Sq. Ft. TB 133, add \$24 List	917	946	953	965	977	988	1000	1011	1024	1079	1119	1158	

ASH WOOD FINISHES:

- #162 White Oak on Ash
- #163 Walnut on Ash
- #164 Cocoa Ash
- #165 Kona Ash
- #166 Smoky Umber Ash
- #167 Slate Grey Ash

OPTIONS (XXXX - REFERS TO STOOL MODEL NUMBER)

MODEL	DESCRIPTION	LIST
XXXX-NS02B	Glides (For Hard-Surface Flooring)	20

Please note all dimensions listed above are nominal.

STARKIE STOOLS

designed by christopher panichella



SIN #711-16

NOTES:

- Models offered with and without back in three heights: 18", 25" and 30".
- Presented in Ash wood, in all standard and custom wood finishes.
- For custom wood finishes (including #01 Pure White), please add one-time upcharge of \$400 List per color per order.
- Seat pad features suspension support for optimum comfort.
- Footring offered in Chrome only and is positioned 5" from the floor for 18" H and 25" H stools, and 10" from the floor for 30" H stools.
- 250 lbs. maximum weight capacity.

SPECIFY:

1. Model number
2. Wood finish
3. Upholstery selection
4. Options, as applicable

ORDERING EXAMPLE:

#3920-18-NS02B

18" Height Stool
Glides

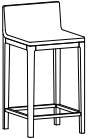
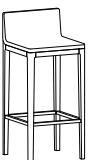
MODEL NUMBER	PRODUCT SPECIFICATIONS	FABRIC GRADES										LEATHER GRADES		
		COM	COL									L1	L2	L3
3920-18 	18" Height Stool, With Back W 16 ¹ / ₄ D 16 ¹ / ₄ H 26 Seat Height 18 ¹ / ₄ Seat Width 16 ¹ / ₄ Seat Depth 14 1 ¹ / ₄ yds. 13 lbs. COL 25 Sq. Ft. TB 133, add \$60 List	1003	1074	1091	1122	1152	1181	1211	1238	1269	1406	1507	1606	
		1021	1092	1109	1140	1170	1199	1229	1256	1287	1424	1525	1624	
3920-25 	25" Height Stool, With Back W 16 ¹ / ₄ D 16 ¹ / ₄ H 33 Seat Height 25 ¹ / ₄ Seat Width 16 ¹ / ₄ Seat Depth 14 1 ¹ / ₄ yds. 15 lbs. COL 25 Sq. Ft. TB 133, add \$60 List	1041	1112	1129	1160	1190	1219	1249	1276	1307	1444	1545	1644	
		1021	1092	1109	1140	1170	1199	1229	1256	1287	1424	1525	1624	
3920-30 	30" Height Stool, With Back W 16 ¹ / ₄ D 16 ¹ / ₄ H 38 Seat Height 30 ¹ / ₄ Seat Width 16 ¹ / ₄ Seat Depth 14 1 ¹ / ₄ yds. 17 lbs. COL 25 Sq. Ft. TB 133, add \$60 List	1041	1112	1129	1160	1190	1219	1249	1276	1307	1444	1545	1644	
		1021	1092	1109	1140	1170	1199	1229	1256	1287	1424	1525	1624	

ASH WOOD FINISHES:

- #162 White Oak on Ash
- #163 Walnut on Ash
- #164 Cocoa Ash
- #165 Kona Ash
- #166 Smoky Umber Ash
- #167 Slate Grey Ash

OPTIONS (XXXX - REFERS TO STOOL MODEL NUMBER)

MODEL	DESCRIPTION	LIST
XXXX-NS02B	Glides (For Hard-Surface Flooring)	20

Please note all dimensions listed above are nominal.

NOTES:

- Signature arm available with black urethane or upholstered arm cap.
- Three arm finish options: #90 Metallic Silver, #91 Chrome or #95 Satin Black.
- Unless specified, arm cap upholstery will match remainder of body upholstery.
- Two mechanism options: Synchro-tilt or knee tilt.
- Fixed back height and pneumatic lift.
- Dual wheel carpet casters suitable for carpet and hard surfaces.
- Maximum weight capacity is 300 lbs.

SPECIFY:

1. Model number
2. Arm finish
3. Upholstery selection
4. Base selection

ORDERING EXAMPLE:





#1581
Mid-Back, Knee Tilt
Polished Aluminum Base

THEORY EXECUTIVE

designed by david dahl



SIN #711-18

MODEL NUMBER	PRODUCT SPECIFICATIONS	BASE FINISH	FABRIC GRADES							LEATHER GRADES				
			COM	1	2	COL			4	5	6	7	8	L1
1580 	Mid-Back, Knee Tilt Urethane Arm Cap W 25 D 25 ¹ / ₂ H 37-41 Seat Height 17-21 Inside Seat Width 19 ¹ / ₂ Inside Seat Depth 19 Arm Height 25 ¹ / ₂ -29 ¹ / ₂ 2 Yds. 51 lbs. COL 40 Sq. Ft. TB 133, add \$96 List	Black Nylon	1447	1561	1588	1636	1685	1731	1779	1823	1872	2092	2254	2411
		Polished Aluminum	1540	1654	1681	1729	1778	1824	1872	1916	1965	2185	2347	2504
1581 	Mid-Back, Knee Tilt Upholstered Arm Cap W 25 D 25 ¹ / ₂ H 37-41 Seat Height 17-21 Inside Seat Width 19 ¹ / ₂ Inside Seat Depth 19 Arm Height 25 ¹ / ₂ -29 ¹ / ₂ 2 ¹ / ₄ Yds. 51 lbs. COL 45 Sq. Ft. TB 133, add \$108 List	Black Nylon	1594	1722	1753	1807	1861	1913	1968	2017	2072	2320	2502	2679
		Polished Aluminum	1686	1814	1845	1899	1953	2005	2060	2109	2164	2412	2594	2771
1585 	Mid-Back, Synchro-Tilt Urethane Arm Cap W 25 D 25 ¹ / ₂ H 37-41 Seat Height 17-21 Inside Seat Width 19 ¹ / ₂ Inside Seat Depth 19 Arm Height 25 ¹ / ₂ -29 ¹ / ₂ 2 Yds. 51 lbs. COL 40 Sq. Ft. TB 133, add \$96 List	Black Nylon	1475	1589	1616	1664	1713	1759	1807	1851	1900	2120	2282	2439
		Polished Aluminum	1567	1681	1708	1756	1805	1851	1899	1943	1992	2212	2374	2531
1586 	Mid-Back, Synchro-Tilt Upholstered Arm Cap W 25 D 25 ¹ / ₂ H 37-41 Seat Height 17-21 Inside Seat Width 19 ¹ / ₂ Inside Seat Depth 19 Arm Height 25 ¹ / ₂ -29 ¹ / ₂ 2 ¹ / ₄ Yds. 51 lbs. COL 45 Sq. Ft. TB 133, add \$108 List	Black Nylon	1621	1749	1780	1834	1888	1940	1995	2044	2099	2347	2529	2706
		Polished Aluminum	1712	1840	1871	1925	1979	2031	2086	2135	2190	2438	2620	2797

THEORY EXECUTIVE

designed by david dahl



SIN #711-18

NOTES:

- Signature arm available with black urethane or upholstered arm cap.
- Three arm finish options: #90 Metallic Silver, #91 Chrome or #95 Satin Black.
- Unless specified, arm cap upholstery will match remainder of body upholstery.
- Two mechanism options: Synchro-tilt or knee tilt.
- Fixed back height and pneumatic lift.
- Dual wheel carpet casters suitable for carpet and hard surfaces.

SPECIFY:

1. Model number
2. Arm finish
3. Upholstery selection
4. Base selection

ORDERING EXAMPLE:

#1591
High Back, Knee Tilt
Black Nylon Base

MODEL NUMBER	PRODUCT SPECIFICATIONS	BASE FINISH	FABRIC GRADES							LEATHER GRADES				
			COM	1	2	COL			4	5	6	7	8	L1
1590	High Back, Knee Tilt Urethane Arm Cap W 25 D 25 ¹ / ₂ H 42-46 Seat Height 17-21 Inside Seat Width 19 ¹ / ₂ Inside Seat Depth 19 Arm Height 25 ¹ / ₂ -29 ¹ / ₂ 2 ¹ / ₄ Yds. 55 lbs. COL 45 Sq. Ft. TB 133, add \$108 List	Black Nylon	1520	1648	1679	1733	1787	1839	1894	1943	1998	2246	2428	2605
		Polished Aluminum	1613	1741	1772	1826	1880	1932	1987	2036	2091	2339	2521	2698
1591	High Back, Knee Tilt Upholstered Arm Cap W 25 D 25 ¹ / ₂ H 42-46 Seat Height 17-21 Inside Seat Width 19 ¹ / ₂ Inside Seat Depth 19 Arm Height 25 ¹ / ₂ -29 ¹ / ₂ 2 ¹ / ₂ Yds. 55 lbs. COL 50 Sq. Ft. TB 133, add \$120 List	Black Nylon	1668	1810	1844	1905	1965	2023	2083	2138	2199	2474	2676	2873
		Polished Aluminum	1759	1901	1935	1996	2056	2114	2174	2229	2290	2565	2767	2964
1595	High Back, Synchro-Tilt Urethane Arm Cap W 25 D 25 ¹ / ₂ H 42-46 Seat Height 17-21 Inside Seat Width 19 ¹ / ₂ Inside Seat Depth 19 Arm Height 25 ¹ / ₂ -29 ¹ / ₂ 2 ¹ / ₄ Yds. 55 lbs. COL 45 Sq. Ft. TB 133, add \$108 List	Black Nylon	1548	1676	1707	1761	1815	1867	1922	1971	2026	2274	2456	2633
		Polished Aluminum	1641	1769	1800	1854	1908	1960	2015	2064	2119	2367	2549	2726
1596	High Back, Synchro-Tilt Upholstered Arm Cap W 25 D 25 ¹ / ₂ H 42-46 Seat Height 17-21 Inside Seat Width 19 ¹ / ₂ Inside Seat Depth 19 Arm Height 25 ¹ / ₂ -29 ¹ / ₂ 2 ¹ / ₂ Yds. 55 lbs. COL 50 Sq. Ft. TB 133, add \$120 List	Black Nylon	1695	1837	1871	1932	1992	2050	2110	2165	2226	2501	2703	2900
		Polished Aluminum	1788	1930	1964	2025	2085	2143	2203	2258	2319	2594	2796	2993

TRANSPIRE DAYBED



PRODUCT FEATURES:

- Each unit comes standard with one flip-up seat cushion (above drawers), one fixed seat cushion, two removable back cushions, one bolster pillow with button accent and two pull-out drawers.
- Back cushions and bolster pillow are clipped into place and can be removed as needed.
- Pull-out drawer face available in laminate only, with PVC edge banding.
- For standard laminates, refer to Standard Finish Card.
- For custom laminates, add \$500 List per color per order. Pre-approval required, please contact Customer Service.
- PVC edge trim available in three colors: platinum gray, mocha brown and black.
- Standard with four locking grey casters.
- Optional 4" fixed legs with non-skid glides available at no upcharge, please specify.
- Legs available in #06 Charcoal Grey, #90 Metallic Silver and #91 Chrome.
- 4" clearance between floor and casters or fixed legs.
- Moisture barrier available on seat cushion.
- Custom sizes available, please contact Customer Service for pricing.
- Maximum weight capacity of 750 lbs.
- Please refer to pages 3-4 for two-tone upholstery examples and yardage requirements.

DIMENSIONS:

Front View

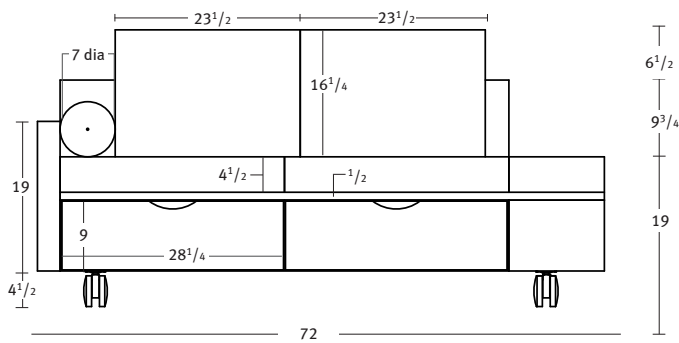

Top View

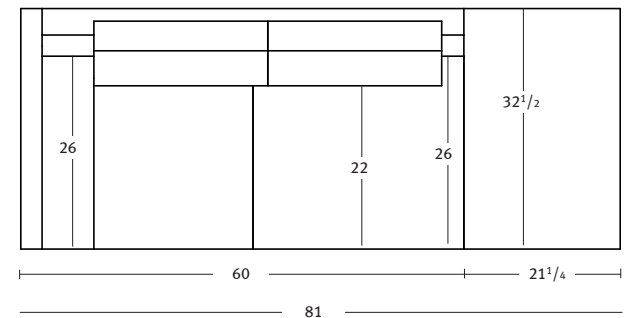
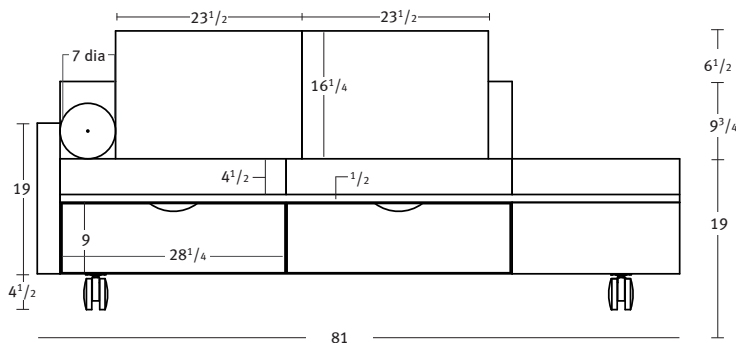
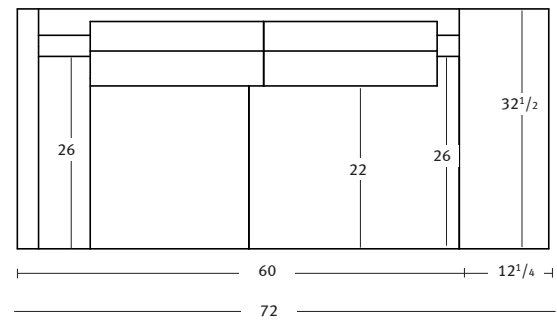

TRANSPIRE DAYBED



NOTES:

- Two daybed sizes available.
- Please specify option code after model number and add upcharges accordingly.
- Refer to pages 3-4 for two-tone upholstery examples and yardage requirements.

SPECIFY:

- Model number
- Drawer laminate finish
- Drawer laminate trim finish
- Upholstery selection
- Leg finish
- Options, as applicable

ORDERING EXAMPLE:

#DBL-813228-MB05

81" Wide Daybed
Moisture Barrier

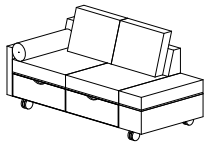
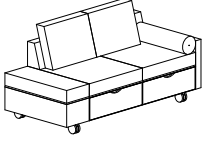
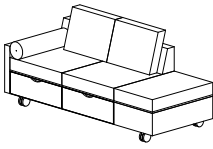
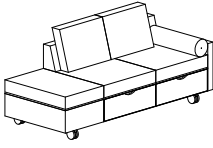
MODEL NUMBER	PRODUCT SPECIFICATIONS	FABRIC GRADES							LEATHER GRADES							
		COM	1	2	COL			3	4	5	6	7	8	L1	L2	L3
DBR-723228 	72" Wide Daybed Arm & Bolster Right, as seated W 72 D 32 ¹ / ₂ H 35 ¹ / ₄ Seat Height 18 Drawer Dimensions (inside clearance) W 28 ¹ / ₄ D 26 H 8 ³ / ₄ Arm Height 23 ¹ / ₂ 12 yds. 160 lbs. TB 133, add \$576 List	4573	5254	5418	5707	5997	6274	6564	6829	7119	8442	9412	10357			
DBL-723228 	72" Wide Daybed Arm & Bolster Left, as seated W 72 D 32 ¹ / ₂ H 35 ¹ / ₄ Seat Height 18 Drawer Dimensions (inside clearance) W 28 ¹ / ₄ D 26 H 8 ³ / ₄ Arm Height 23 ¹ / ₂ 12 yds. 160 lbs. TB 133, add \$576 List	4573	5254	5418	5707	5997	6274	6564	6829	7119	8442	9412	10357			
DBR-813228 	81" Wide Daybed Arm & Bolster Right, as seated W 81 D 32 ¹ / ₂ H 35 ¹ / ₄ Seat Height 18 Drawer Dimensions (inside clearance) W 28 ¹ / ₄ D 26 H 8 ³ / ₄ Arm Height 23 ¹ / ₂ 13 yds. 175 lbs. TB 133, add \$624 List	4771	5509	5686	6000	6314	6614	6928	7215	7529	8962	10013	11037			
DBL-813228 	81" Wide Daybed Arm & Bolster Left, as seated W 81 D 32 ¹ / ₂ H 35 ¹ / ₄ Seat Height 18 Drawer Dimensions (inside clearance) W 28 ¹ / ₄ D 26 H 8 ³ / ₄ Arm Height 23 ¹ / ₂ 13 yds. 175 lbs. TB 133, add \$624 List	4771	5509	5686	6000	6314	6614	6928	7215	7529	8962	10013	11037			

OPTIONS (XXXX - REFERS TO CHAIR MODEL NUMBER)

MODEL	DESCRIPTION	LIST
XXXX-MB04	72" W Daybed Moisture Barrier	170
XXXX-MB05	81" W Daybed Moisture Barrier	215

UPHOLSTERY COMBINATIONS:

For fabric, vinyl or leather upholstery combinations, refer to the pricing below:

- When combining **two** COM/COV/COL fabrics, or fabrics with the same grade, add \$125 List per unit.
- When combining **three or more** COM/COV/COL fabrics, or fabrics with the same grade, add \$175 List per unit.
- When combining different grades of fabric, price will be based on the highest grade specified.

- Two-tone upholstery examples and yardage requirements for the most common combinations are listed below. Additional combinations available, please contact Customer Service for yardage requirements and pricing.
- Note: Yardage amounts are based on fabric which is plain (i.e. non-directional) and a full 54" wide.
- **Appropriate upholstery code must be included on order.**

TRANSPIRE DAYBED

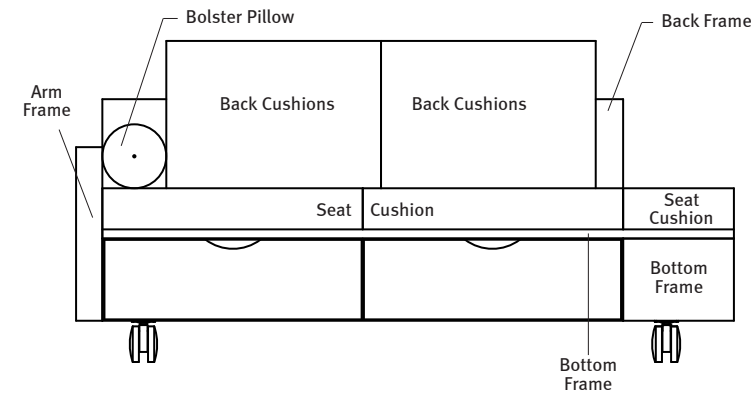

72" Wide Daybed

<u>Model</u>	<u>COM Requirement</u>
DBR-723228	Back & Bottom Frame = 4 ¹ / ₂ yds.
DBL-723228	Seat Cushions = 3 ¹ / ₄ yds.
	Arm Frame = 1 ¹ / ₄ yds.
	Back Cushions (qty. 2) = 2 ³ / ₄ yds. (total for both)
	Bolster Pillows = 1 yd.

81" Wide Daybed

<u>Model</u>	<u>COM Requirement</u>
DBR-813228	Back & Bottom Frame = 5 yds.
DBL-813228	Seat Cushions = 3 ¹ / ₄ yds.
	Arm Frame = 1 ¹ / ₄ yds.
	Back Cushions (qty. 2) = 2 ³ / ₄ yds. (total for both)
	Bolster Pillows = 1 yd.

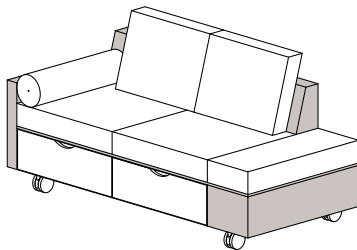

Code	DB1
<u>Model</u>	<u>COM Requirement</u>
DBR-723228	Back, Bottom and Arm Frame = 5 ³ / ₄ yds.
DBL-723228	Balance of Daybed = 7 yds.

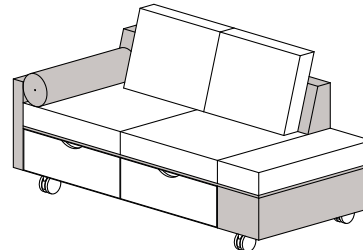

Code	DB2
<u>Model</u>	<u>COM Requirement</u>
DBR-723228	Back, Bottom and Arm Frame and Bolster Pillow = 6 ³ / ₄ yds.
DBL-723228	Balance of Daybed = 6 yds.

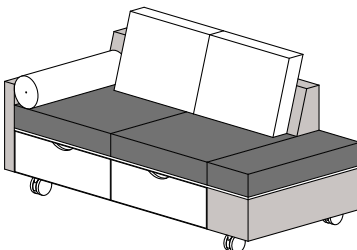

Code	DB3
<u>Model</u>	<u>COM Requirement</u>
DBR-723228	Back, Bottom and Arm Frame = 5 ³ / ₄ yds.
DBL-723228	Seat Cushions = 3 ¹ / ₄ yds.
	Back Cushions and Bolster Pillow = 3 ³ / ₄ yds.

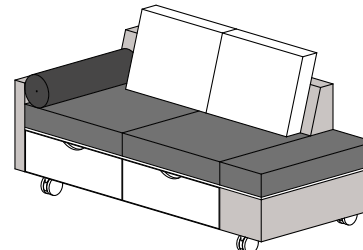

Code	DB4
<u>Model</u>	<u>COM Requirement</u>
DBR-723228	Back, Bottom and Arm Frame = 5 ³ / ₄ yds.
DBL-723228	Seat Cushions = 3 ¹ / ₄ yds.
	Bolster Pillow = 1 yd. (please specify button fabric)
	Back Cushions = 2 ³ / ₄ yds.

TRANSPIRE DAYBED

UPHOLSTERY COMBINATIONS:

For fabric, vinyl or leather upholstery combinations, refer to the pricing below:

- When combining **two** COM/COV/COL fabrics, or fabrics with the same grade, add \$125 List per unit.
- When combining **three or more** COM/COV/COL fabrics, or fabrics with the same grade, add \$175 List per unit.
- When combining different grades of fabric, price will be based on the highest grade specified.
- Two-tone upholstery examples and yardage requirements for the most common combinations are listed below. Additional combinations available, please contact Customer Service for yardage requirements and pricing.
- Note: Yardage amounts are based on fabric which is plain (i.e. non-directional) and a full 54" wide.
- **Appropriate upholstery code must be included on order.**

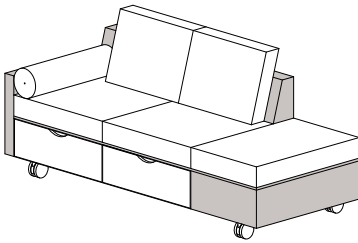

Code DB5

<u>Model</u>	<u>COM Requirement</u>
DBR-813228	Back, Bottom and Arm Frame = 6 ¹ / ₄ yds.
DBL-813228	Balance of Daybed = 7 yds.

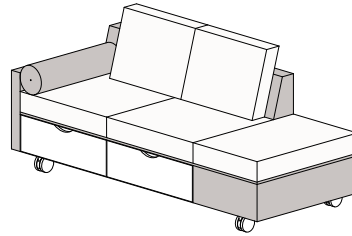

Code DB6

<u>Model</u>	<u>COM Requirement</u>
DBR-813228	Back, Bottom and Arm Frame and Bolster Pillow = 7 ¹ / ₄ yds.
DBL-813228	Balance of Daybed = 6 yds.

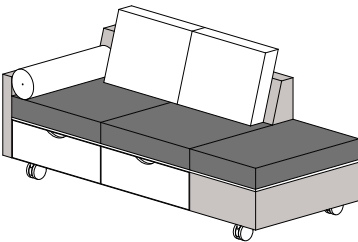

Code DB7

<u>Model</u>	<u>COM Requirement</u>
DBR-813228	Back, Bottom and Arm Frame = 6 ¹ / ₄ yds.
DBL-813228	Seat Cushions = 3 ¹ / ₄ yds. Back Cushions and Bolster Pillow = 3 ³ / ₄ yds.

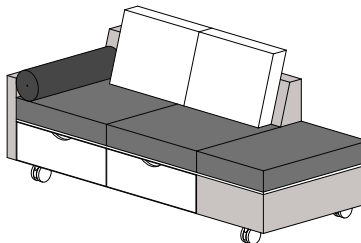

Code DB8

<u>Model</u>	<u>COM Requirement</u>
DBR-813228	Back, Bottom and Arm Frame = 6 ¹ / ₄ yds.
DBL-813228	Seat Cushions = 3 ¹ / ₄ yds. Bolster Pillow = 1 yd. (please specify button fabric) Back Cushions = 2 ³ / ₄ yds.



UPTOWN SOCIAL BENCHES

designed by chris and jon panichella

SIN #711-16

PRODUCT FEATURES:

- Single, 2-seat, 3-seat models as well as square and round models.
- Select benches available with integrated tables.
- Tables feature upholstered body with three top surface options: veneer, laminate or Corian.
- Veneer offered in Walnut and White Oak, in all standard and custom wood finishes.
- For standard laminates, refer to Standard Finish Card.
- For custom laminates, add \$500 List per color per order. Pre-approval required, please contact Customer Service.
- For Corian top, specify “-CO” next to model number. Corian top is 1/2" thick and will increase overall table height by 1/4".
- Corian top available in four standard colors. For non-standard colors, please contact Customer Service for pricing.
- Optional wood trim is featured on all sides and can be specified in Walnut and White Oak, in all standard and custom finishes. Refer to individual pages for applicable upcharge.
- Tufted stitching detail available on seat cushions, please refer to individual pages for applicable upcharge.
- For custom wood finishes (to tables and/or wood trim), please add one-time upcharge of \$400 List per color per order.
- Die-cast aluminum legs feature adjustable glides and are available in standard and premium finishes, options listed below.
- For premium metal finishes, please specify “-PF04” with color selection and add \$135 List per unit.
- Non-skid glides available for hard surface floors, please specify “-NS02B” after model number and add \$20 List per unit.
- Two-tone upholstery examples and yardage requirements featured on pages 7-8.

STANDARD LEG FINISH COLORS:

- #06 Charcoal Grey
- #90 Metallic Silver
- #92 Polished Aluminum
- #95 Satin Black

PREMIUM LEG FINISH COLORS:

- #07 Gold Shimmer
- #08 Penny
- #09 Brown Sugar
- #83 Metallic Champagne
- #94 Cotton

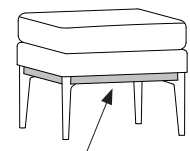

optional wood trim

CORIAN® COLORS:

- Designer White
- Linen
- Rain Cloud
- Witch Hazel

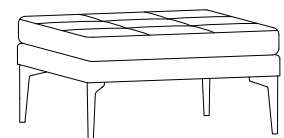

optional tufted stitching detail

Corian® is a registered trademark of Dupont.

UPTOWN SOCIAL BENCHES

designed by chris and jon panichella



SIN #711-16

POWER UNITS:

- For placement on integrated tables only.
- Unit will be positioned in the center as standard, unless otherwise specified.
- PB1 and PB2 dimensions: 5³/₄" W x 2¹/₂" D
- PB3 dimensions: 6¹/₂" W x 2¹/₂" D
- Metallic Silver or White finish with 108" electrical cord.
- UL listed.

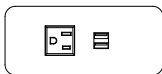

PB1

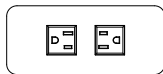

PB2

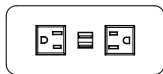

PB3

- PB1 unit features one outlet and two USB charging ports.
- PB2 unit features two outlets.
- PB3 unit features two outlets and two USB charging ports.

NOTES:

- Metal legs available in standard and premium finishes.
- Refer to page 7 for two-tone upholstery examples and yardage requirements.

SPECIFY:

1. Model number
2. Leg finish
3. Upholstery selection
4. Options, as applicable

ORDERING EXAMPLE:



#5121-30-NS02B
30" Square Bench
Non-Skid Glides

UPTOWN SOCIAL BENCHES

designed by chris and jon panichella

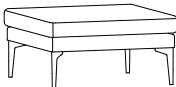
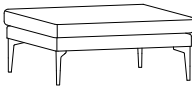
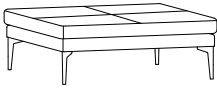

SIN #711-16

MODEL NUMBER	PRODUCT SPECIFICATIONS	FABRIC GRADES								LEATHER GRADES			
		COM	1	2	COL			6	7	8	L1	L2	L3
5120-18 	18" Square Bench W 18 D 18 H 17 ¹ / ₄ 1 ¹ / ₂ yds. 19 lbs. COL 30 Sq. Ft. TB 133, add \$72 List	908	994	1014	1050	1086	1121	1157	1190	1227	1392	1513	1631
5120-24 	24" Square Bench W 24 D 24 H 17 ¹ / ₄ 1 ³ / ₄ yds. 24 lbs. COL 35 Sq. Ft. TB 133, add \$84 List	1045	1145	1169	1211	1253	1294	1336	1374	1417	1610	1751	1889
5120-30 	30" Square Bench W 30 D 30 H 17 ¹ / ₄ 2 ³ / ₄ yds. 33 lbs. COL 55 Sq. Ft. TB 133, add \$132 List	1236	1392	1430	1496	1563	1626	1693	1753	1820	2123	2345	2562
5120-36 	36" Square Bench W 36 D 36 H 17 ¹ / ₄ 2 ³ / ₄ yds. 42 lbs. COL 55 Sq. Ft. TB 133, add \$132 List	1506	1662	1700	1766	1833	1896	1963	2023	2090	2393	2615	2832
5120-42 	42" Square Bench W 42 D 42 H 17 ¹ / ₄ 4 yds. 53 lbs. COL 80 Sq. Ft. TB 133, add \$192 List	1821	2048	2103	2199	2296	2388	2485	2573	2670	3111	3434	3749

OPTIONS (XXXX - REFERS TO BENCH MODEL NUMBER)

MODEL	DESCRIPTION	LIST	WEIGHT CAPACITY
XXXX-WT01	Wood Trim - 18" and 24" Square	272	#5121-18 350 lbs.
XXXX-WT02	Wood Trim - 30" and 36" Square	380	#5121-24 350 lbs.
XXXX-WT03	Wood Trim - 42" Square	464	#5121-30 350 lbs.
XXXX-TSS01	Tufted Stitch Detail	120	#5121-36 700 lbs.
XXXX-NS02B	Non-Skid Glides	20	#5121-42 700 lbs.
XXXX-PF04	Premium Leg Finish	135	

UPTOWN SOCIAL BENCHES

designed by chris and jon panichella

NOTES:

- Metal legs available in standard and premium finishes.
- Refer to page 7 for two-tone upholstery examples and yardage requirements.



SPECIFY:

1. Model number
2. Leg finish
3. Upholstery selection
4. Options, as applicable

ORDERING EXAMPLE:

#5125-24-PF04
24" Round Bench
Premium Leg Finish

SIN #711-16

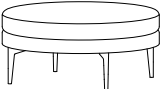
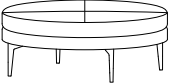
MODEL NUMBER	PRODUCT SPECIFICATIONS	FABRIC GRADES								LEATHER GRADES			
		COM	1	2	COL			6	7	8	L1	L2	L3
5125-18 	18" Round Bench W 18 D 18 H 17 ¹ / ₄ 1 ¹ / ₄ yds. 16 lbs. COL 25 Sq. Ft. TB 133, add \$60 List	931	1002	1019	1050	1080	1109	1139	1166	1197	1334	1435	1534
5125-24 	24" Round Bench W 24 D 24 H 17 ¹ / ₄ 2 yds. 20 lbs. COL 40 Sq. Ft. TB 133, add \$96 List	1074	1188	1215	1263	1312	1358	1406	1450	1499	1719	1881	2038
5125-30 	30" Round Bench W 30 D 30 H 17 ¹ / ₄ 3 yds. 40 lbs. COL 60 Sq. Ft. TB 133, add \$144 List	1266	1437	1478	1550	1622	1692	1764	1830	1903	2234	2476	2712
5125-36 	36" Round Bench W 36 D 36 H 17 ¹ / ₄ 3 ¹ / ₂ yds. 56 lbs. COL 70 Sq. Ft. TB 133, add \$168 List	1544	1743	1791	1875	1960	2041	2125	2202	2287	2673	2956	3231
5125-42 	42" Round Bench W 42 D 42 H 17 ¹ / ₄ 4 ¹ / ₂ yds. 69 lbs. COL 90 Sq. Ft. TB 133, add \$216 List	1868	2124	2185	2294	2402	2506	2615	2714	2823	3319	3683	4037

OPTIONS (XXXX - REFERS TO BENCH MODEL NUMBER)

MODEL	DESCRIPTION	LIST	WEIGHT CAPACITY
XXXX-WT01	Wood Trim - 18" and 24" Round	272	#5125-18 350 lbs.
XXXX-WT02	Wood Trim - 30" and 36" Round	380	#5125-24 350 lbs.
XXXX-WT03	Wood Trim - 42" Round	464	#5125-30 350 lbs.
XXXX-TSS01	Tufted Stitch Detail	120	#5125-36 700 lbs.
XXXX-NS02B	Non-Skid Glides	20	#5125-42 700 lbs.
XXXX-PF04	Premium Leg Finish	135	

NOTES:

- Table available in Walnut or White Oak veneer, laminate and Corian selections.
- Metal legs available in standard and premium finishes.
- Refer to page 8 for two-tone upholstery examples and yardage requirements.

SPECIFY:

1. Model number
2. Table finish, as applicable
3. Leg finish
4. Upholstery selection
5. Options, as applicable

ORDERING EXAMPLE:

#5114-TR-PB1-W
60-Degree Bench/Table
Power Band 1, White

**UPTOWN SOCIAL
BENCHES**

designed by chris and jon panichella

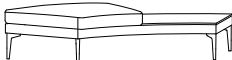
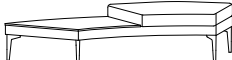
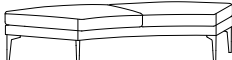

SIN #711-16

MODEL NUMBER	PRODUCT SPECIFICATIONS	FABRIC GRADES							LEATHER GRADES				
		COM	1	2	COL			8	L1	L2	L3		
5126 	30-Degree Single Seat Bench W 41 ¹ / ₂ D 32 H 17 ¹ / ₄ 3 ³ / ₄ yds. 41 lbs. COL 75 Sq. Ft. TB 133, add \$180 List	1182	1395	1446	1537	1627	1714	1805	1887	1978	2391	2694	2990
5114-TL 	60-Degree Bench/Table Combination Table Left, As Seated W 79 D 31 ³ / ₄ H 17 ¹ / ₄ 4 ¹ / ₂ yds. 52 lbs. COL 90 Sq. Ft. TB 133, add \$216 List	2145	2401	2462	2571	2679	2783	2892	2991	3100	3596	3960	4314
5114-TR 	60-Degree Bench/Table Combination Table Right, As Seated W 79 D 31 ³ / ₄ H 17 ¹ / ₄ 4 ¹ / ₂ yds. 52 lbs. COL 90 Sq. Ft. TB 133, add \$216 List	2145	2401	2462	2571	2679	2783	2892	2991	3100	3596	3960	4314
5127 	60-Degree 2-Seat Bench W 79 D 31 ³ / ₄ H 17 ¹ / ₄ 7 ¹ / ₂ yds. 57 lbs. COL 150 Sq. Ft. TB 133, add \$360 List	1477	1903	2005	2186	2367	2541	2722	2887	3068	3895	4501	5092

OPTIONS (XXXX - REFERS TO BENCH MODEL NUMBER)

MODEL	DESCRIPTION	LIST	WEIGHT CAPACITY	
XXXX-WT01	Wood Trim - Model #5126	272	#5114	350 lbs.
XXXX-WT02	Wood Trim - Models #5114 & 5127	380	#5126	700 lbs.
XXXX-TSS01	Tufted Stitch Detail	120	#5127	700 lbs.
XXXX-CO	Corian Table Top	1369		
XXXX-NS02B	Non-Skid Glides	20		
XXXX-PF04	Premium Leg Finish	135		
Table Power Units				
XXXX-PB1-S	Power Band 1 (one power, two USB), Silver	413		
XXXX-PB1-W	Power Band 1 (one power, two USB), White	413		
XXXX-PB2-S	Power Band 2 (dual power), Silver	322		
XXXX-PB2-W	Power Band 2 (dual power), White	322		
XXXX-PB3-S	Power Band 3 (dual power, two USB), Silver	429		
XXXX-PB3-W	Power Band 3 (dual power, two USB), White	429		

UPTOWN SOCIAL BENCHES

designed by chris and jon panichella



SIN #711-16

NOTES:

- Center table available in Walnut or White Oak veneer, laminate and Corian selections.
- Metal legs available in standard and premium finishes.
- Refer to page 7 for two-tone upholstery examples and yardage requirements.

SPECIFY:

- Model number
- Table finish, as applicable
- Leg finish
- Upholstery selection
- Options, as applicable

ORDERING EXAMPLE:

#5124-WT03-PF04
Two-Seat Bench w/Center Table
Wood Trim Detail
Premium Leg Finish

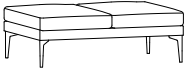
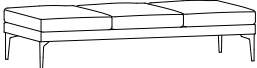
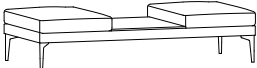
MODEL NUMBER	PRODUCT SPECIFICATIONS	FABRIC GRADES							LEATHER GRADES							
		COM	1	2	COL			3	4	5	6	7	8	L1	L2	L3
5128	 <p>Q S Two-Seat Bench W 50 D 22 H 17¹/₄ 3¹/₄ yds. 49 lbs. COL 65 Sq. Ft. TB 133, add \$156 List</p>	1208	1393	1437	1516	1594	1669	1748	1819	1898	2256	2519	2775			
5129	 <p>Q S Three-Seat Bench W 75 D 22 H 17¹/₄ 4³/₄ yds. 83 lbs. COL 95 Sq. Ft. TB 133, add \$228 List</p>	1551	1821	1886	2000	2115	2225	2340	2444	2559	3083	3467	3841			
5129-T	 <p>Two-Seat Bench with Center Table W 75 D 22 H 17¹/₄ 3³/₄ yds. 78 lbs. COL 75 Sq. Ft. TB 133, add \$180 List</p>	1786	1999	2050	2141	2231	2318	2409	2491	2582	2995	3298	3594			

OPTIONS (XXXX - REFERS TO BENCH MODEL NUMBER)

MODEL	DESCRIPTION	LIST
XXXX-WT02	Wood Trim - Model #5128	380
XXXX-WT03	Wood Trim - Models #5129 & #5129-T	464
XXXX-TSS01	Tufted Stitch Detail	120
XXXX-CO	Corian Top - Model #5129-T	540
XXXX-NS02B	Non-Skid Glides	20
XXXX-PF04	Premium Leg Finish	135
Table Power Units		
XXXX-PB1-S	Power Band 1 (one power, two USB), Silver	413
XXXX-PB1-W	Power Band 1 (one power, two USB), White	413
XXXX-PB2-S	Power Band 2 (dual power), Silver	322
XXXX-PB2-W	Power Band 2 (dual power), White	322
XXXX-PB3-S	Power Band 3 (dual power, two USB), Silver	429
XXXX-PB3-W	Power Band 3 (dual power, two USB), White	429

Q S = Available on Quick-Ship Program (standard leg finishes only).

UPHOLSTERY COMBINATIONS:

For fabric, vinyl or leather upholstery combinations, refer to the pricing below:

- When combining **two** COM/COV/COL fabrics, or fabrics with the same grade, price will be \$65 List (per unit).
- When combining **three or more** COM/COV/COL fabrics, or fabrics with the same grade, price will be \$75 List (per unit).
- When combining different grades of fabric, price will be based on the highest grade specified.

- Two-tone upholstery examples and yardage requirements for the most common combinations are listed below. Additional combinations available, please contact Customer Service for yardage requirements and pricing.
- Note: Yardage amounts are based on fabric which is plain (i.e. non-directional) and a full 54" wide.
- **Appropriate upholstery code must be included on order.**

UPTOWN SOCIAL
BENCHES

designed by chris and jon panichella

SIN #711-16



Code US46
Model 5120-18
COM Requirement
Seat Cushion = $1\frac{1}{4}$ yds.
Balance of Bench = $\frac{3}{4}$ yd.



Code US47
Model 5120-24
COM Requirement
Seat Cushion = $1\frac{1}{2}$ yds.
Balance of Bench = 1 yd.

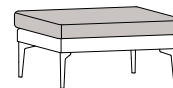

Code US48
Model 5120-30
COM Requirement
Seat Cushion = 2 yds.
Balance of Bench = $1\frac{1}{4}$ yds.

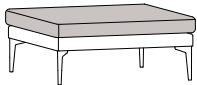

Code US49
Model 5120-36
COM Requirement
Seat Cushion = $2\frac{1}{4}$ yds.
Balance of Bench = $1\frac{1}{4}$ yds.

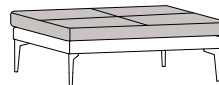

Code US50
Model 5120-42
COM Requirement
Seat Cushion = 3 yds.
Balance of Bench = $1\frac{1}{2}$ yds.



Code US51
Model 5125-18
COM Requirement
Seat Cushion = 1 yd.
Balance of Bench = $\frac{3}{4}$ yd.

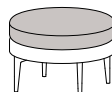

Code US52
Model 5125-24
COM Requirement
Seat Cushion = $1\frac{1}{2}$ yds.
Balance of Bench = 1 yd.

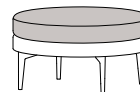

Code US53
Model 5125-30
COM Requirement
Seat Cushion = $2\frac{1}{4}$ yds.
Balance of Bench = 1 yd.

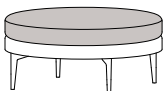

Code US54
Model 5125-36
COM Requirement
Seat Cushion = $2\frac{1}{2}$ yds.
Balance of Bench = $1\frac{1}{4}$ yds.

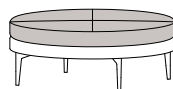

Code US55
Model 5125-42
COM Requirement
Seat Cushion = $3\frac{1}{4}$ yds.
Balance of Bench = $1\frac{1}{2}$ yds.

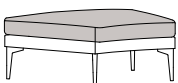

Code US24
Model 5126
COM Requirement
Seat Cushion = 3 yds.
Balance of Bench = $1\frac{1}{4}$ yds.

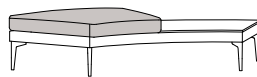

Code US25
Model 5114-TL
5114-TR
COM Requirement
Seat Cushion = 3 yds.
Balance of Bench = $1\frac{1}{2}$ yds.

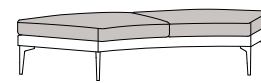

Code US26
Model 5127
COM Requirement
Seat Cushion = $6\frac{1}{4}$ yds.
Balance of Bench = $1\frac{1}{2}$ yds.

UPTOWN SOCIAL BENCHES

designed by chris and jon panichella

UPHOLSTERY COMBINATIONS:

For fabric, vinyl or leather upholstery combinations, refer to the pricing below:

- When combining **two** COM/COV/COL fabrics, or fabrics with the same grade, price will be \$65 List (per unit).
- When combining **three or more** COM/COV/COL fabrics, or fabrics with the same grade, price will be \$75 List (per unit).
- When combining different grades of fabric, price will be based on the highest grade specified.
- Two-tone upholstery examples and yardage requirements for the most common combinations are listed below. Additional combinations available, please contact Customer Service for yardage requirements and pricing.
- Note: Yardage amounts are based on fabric which is plain (i.e. non-directional) and a full 54" wide.
- **Appropriate upholstery code must be included on order.**

SIN #711-16

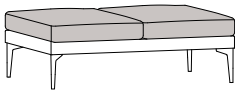

Code US56
Model 5128
COM Requirement
 Seat Cushion = 2¹/₄ yds.
 Balance of Bench = 1¹/₄ yds.

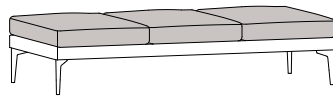

Code US57
Model 5129
COM Requirement
 Seat Cushion = 3¹/₄ yds.
 Balance of Bench = 1¹/₂ yds.

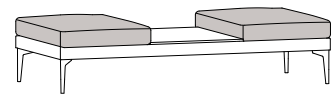

Code US58
Model 5129-T
COM Requirement
 Seat Cushion = 3 yds.
 Balance of Bench = 1¹/₂ yds.



UPTOWN SOCIAL LOUNGE-MODULAR

designed by chris and jon panichella

SIN #711-16

LOUNGE PRODUCT FEATURES:

- Arm and armless lounge, love seat, sofa and chaise models available individually or in modular combinations with integrated tables and/or benches.
- 4" and 7" arm widths available on lounge, love seat and sofa models. Chaise lounge available with 4" arm width only.
- Optional arm cap offered in Walnut or White Oak, as well as Corian.
- Back and seat cushions are removable for cleaning or replacement purposes.
- Integrated tables feature upholstered body and three top surface options: veneer, laminate and Corian.
- Veneer available in Walnut and White Oak, in all standard and custom wood finishes.
- Die-cast aluminum legs feature adjustable glides and are available in standard and premium finishes, options listed below.
- For premium metal finishes, please specify "-PF04" with color selection and add \$135 List per unit.
- Non-skid glides available for hard surface floors, please specify "-NS02B" after model number and add \$20 List per unit.
- Maximum weight capacity is 350 lbs. for lounge chairs, 700 lbs. for love seats and chaise models, and 1000 lbs. for sofas.
- Optional wood trim is featured on all sides below the upholstered frame. Available in Walnut and White Oak, in all standard and custom finishes, please refer to individual pages for applicable upcharge.
- Tufted stitching detail available on back and seat cushion, please refer to individual pages for applicable upcharge.
- Power technology available on front or side of arms.
- Please refer to pages 18-20 for two-tone upholstery examples and yardage requirements.
- All dimensions are nominal.

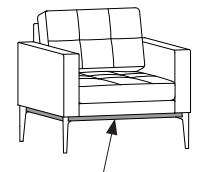

optional wood trim shown
with tufting stitch detail

STANDARD LEG FINISH COLORS:

#06 Charcoal Grey
#90 Metallic Silver
#92 Polished Aluminum
#95 Satin Black

PREMIUM LEG FINISH COLORS:

#07 Gold Shimmer #83 Metallic Champagne
#08 Penny #94 Cotton
#09 Brown Sugar

CORIAN® COLORS:

Designer White
Rain Cloud
Linen
Witch Hazel

Corian® is a registered trademark of Dupont.

FREE-STANDING TABLES PRODUCT FEATURES:

- Tables available in all wood or with upholstered body.
- Three finish material options:
 - › Veneer top with veneer body as standard, unless otherwise specified.
 - › Laminate top with laminate body as standard, unless otherwise specified.
 - › Corian top with veneer or laminate body. **Wood species and finish selection must be specified.**
- Veneer available in Walnut and White Oak, in all standard and custom wood finishes.
- For custom wood finishes (to tables, wood trim and/or pull-up table), please add one-time upcharge of \$400 List per color per order.
- For standard laminates, refer to Standard Finish Card.

UPTOWN SOCIAL LOUNGE-MODULAR

designed by chris and jon panichella

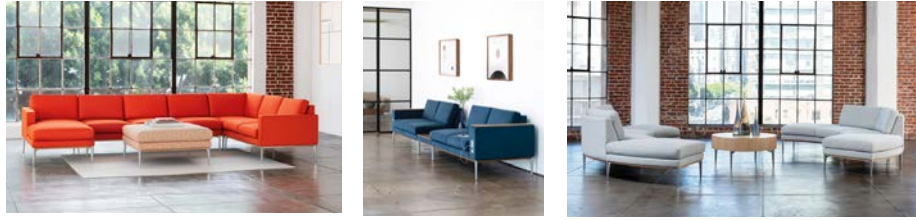

SIN #711-16

FREE-STANDING TABLES PRODUCT FEATURES CONTINUED:

- For custom laminates, add \$500 List per color per order. Pre-approval required, please contact Customer Service.
- For Corian top, specify “-CO” next to model number. For all wood tables, Corian is affixed to top surface increasing overall table height by 1/2". Additionally, a 1/8" reveal will be present. When specified with upholstered sides, Corian top will increase overall table height by 1/4".
- Corian available in four standard colors. For non-standard colors, please contact Customer Service for pricing.
- Tables feature four (4) metal legs and are available in all standard and premium finishes.
- For premium metal finishes, please specify “-PF04” with color selection and add \$135 List per unit.
- Optional wood trim available in Walnut and White Oak, in all standard and custom finishes. Please refer to individual pages for applicable upcharge.
- Non-skid glides available for hard surface floors, please specify “-NS02B” after model number and add \$20 List per unit.

MODULAR BENCH PRODUCT FEATURES:

- Available in single, 2-seat and 3-seat combinations, as well as 2-seat with integrated center table, 30-degree and 60-degree models.
- Optional wood trim is featured on all sides below the upholstered frame, please refer to individual pages for applicable upcharge.
- Center table and wood trim available in Walnut and White Oak wood species, in all standard and custom finishes.
- For custom wood finishes (to tables, wood trim and/or pull-up table), please add one-time upcharge of \$400 List per color per order.
- For standard laminates, refer to Standard Finish Card.
- For custom laminates, please contact Customer Service for pricing.
- Benches feature four (4) metal legs and are available in all standard and premium finishes.
- For premium metal finishes, please specify “-PF04” with color selection and add \$135 List per unit.
- Non-skid glides available for hard surface floors, please specify “-NS02B” after model number and add \$20 List per unit.
- Please refer to page 19 for two-tone upholstery examples and yardage requirements.

POWER UNITS:

- PB1 and PB2 units available on front or side of arms.
- Standard placement for seating units is depicted below. For placement elsewhere, please contact Customer Service.
- PB1, PB2 and PB3 units available on all table tops.
- Unit will be positioned in the center of integrated tables, 5" from the rear, as standard, unless otherwise specified.
- PB1 and PB2 dimensions: 5 3/4" W x 2 1/2" D
- PB3 dimensions: 6 1/2" W x 2 1/2" D
- Metallic Silver or White finish with 108" electrical cord.
- UL listed.

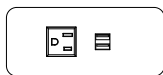

PB1

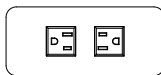

PB2



PB3

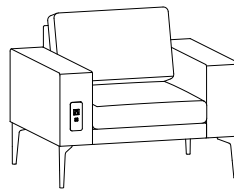

front of arm placement is 3" from the bottom of the frame, centered vertically

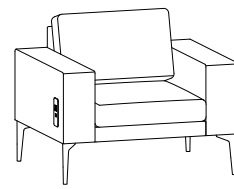

side of arm placement is 3" both vertically and horizontally from the bottom of the frame

- PB1 unit features one outlet and two USB charging ports.
- PB2 unit features two outlets.
- PB3 unit features two outlets and two USB charging ports.



UPTOWN SOCIAL LOUNGE-MODULAR

designed by chris and jon panichella

SIN #711-16

PULL-UP TABLE:

- Table available in Walnut and White Oak as well as laminate and Corian selections.
- Table top dimensions: 18" W x 12" D
- All standard and custom wood finishes available, with matching edge finish.
- For custom wood finishes (to tables, wood trim and/or pull-up table), please add one-time upcharge of \$400 List per color per order.
- For standard laminates, edge finish is as follows:
 - › Wood grain laminates, edge will match the laminate top color, unless otherwise specified.
 - › Solid color laminates, edge will be natural (clear coat) as standard, unless otherwise specified.
- For custom laminates, add \$500 List per color per order. Pre-approval required, please contact Customer Service.
- For Corian top, specify "-CO" next to model number and select color. Edge finish is as follows:
 - › Designer White, Rain Cloud and Linen colors, edge will be white as standard, unless otherwise specified.
 - › Witch Hazel, edge will be natural (clear coat) as standard, unless otherwise specified.
- Edges are also available in all standard wood finishes, please specify. For custom edge finishes, please add one-time upcharge of \$400 List per color, per order.
- Metal base available in standard and premium finishes.

MODULAR ARRANGEMENTS:

- Optional ganging bracket available, please specify "-GC06" with quantity and add \$75 List per unit. One bracket connects two units together.
- **Note: Please include layout drawings or sketch with order.**
- Field assembly required.



UPTOWN SOCIAL LOUNGE-MODULAR

designed by chris and jon panichella

NOTES:

- Available individually or in modular combinations.
- For modular arrangements, a layout drawing or sketch must accompany each order.**
- Refer to pages 18-20 for two-tone upholstery examples and yardage requirements.

SPECIFY:

- Model number
- Leg finish
- Upholstery selection
- Options, as applicable

ORDERING EXAMPLE:

#5101-PF04
Armless Lounge Chair
Premium Leg Finish

SIN #711-16

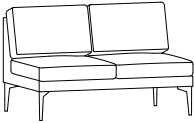
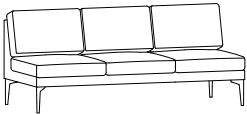
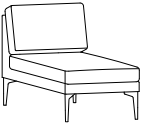
MODEL NUMBER	PRODUCT SPECIFICATIONS	FABRIC GRADES							LEATHER GRADES				
		COM	1	2	COL 3	4	5	6	7	8	L1	L2	L3
5101 	Lounge Chair, Armless W 25 D 31 ³ / ₄ H 31 Seat Height 17 ¹ / ₄ Inside Seat Width 25 Inside Seat Depth 22 3 ¹ / ₂ yds. COL 70 sq. ft. 42 lbs. TB 133, add \$168 List	1284	1483	1531	1615	1700	1781	1865	1942	2027	2413	2696	2971
5102 	Love Seat, Armless W 50 D 31 ³ / ₄ H 31 Seat Height 17 ¹ / ₄ Inside Seat Width 50 Inside Seat Depth 22 5 ³ / ₄ yds. COL 115 sq. ft. 62 lbs. TB 133, add \$276 List	1888	2215	2293	2432	2571	2704	2842	2969	3108	3742	4207	4660
5103 	Sofa, Armless W 75 D 31 ³ / ₄ H 31 Seat Height 17 ¹ / ₄ Inside Seat Width 75 Inside Seat Depth 22 9 yds. COL 180 sq. ft. 97 lbs. TB 133, add \$432 List	2513	3024	3147	3364	3581	3789	4007	4205	4422	5415	6142	6851
5105 	Chaise Lounge, Armless W 29 D 57 ³ / ₄ H 31 Seat Height 17 ¹ / ₄ Inside Seat Width 25 Inside Seat Depth 47 5 ³ / ₄ yds. COL 115 sq. ft. 61 lbs. TB 133, add \$276 List	1833	2160	2238	2377	2516	2649	2787	2914	3053	3687	4152	4605

To add single arms, please refer to page 9

OPTIONS (XXXX - REFERS TO CHAIR MODEL NUMBER)

MODEL	DESCRIPTION	LIST
XXXX-WT01	Wood Trim - Lounge Chair	272
XXXX-WT02	Wood Trim - Love Seat & Chaise Lounge	380
XXXX-WT03	Wood Trim - Sofa	464
XXXX-TSB01	Tufted Stitch Detail, Back Cushion (per cushion)	95
XXXX-TSS01	Tufted Stitch Detail, Seat Cushion (per cushion)	120
XXXX-TSS02	Tufted Stitch Detail, Chaise Lounge Seat Cushion	140
XXXX-NS02B	Non-Skid Glides	20
XXXX-PF04	Premium Leg Finish	135
GC06 (ordered separately)	Gangung Connector	75

Q S = Available on Quick-Ship Program (standard finishes only).

NOTES:

- Models with 4" wide arms.
- Available individually or in modular combinations.
- **For modular arrangements, a layout drawing or sketch must accompany each order.**
- Optional arm cap offered in Walnut or White Oak, as well as Corian.
- Metal legs available in standard and premium finishes.
- Refer to pages 18-20 for two-tone upholstery examples and yardage requirements.

SPECIFY:

1. Model number
2. Leg finish
3. Upholstery selection
4. Options, as applicable

ORDERING EXAMPLE:

#5102-4LR-CO04-WT02

Love Seat
Corian Arm Caps
Wood Trim

**UPTOWN SOCIAL
LOUNGE-MODULAR**

designed by chris and jon panichella

SIN #711-16

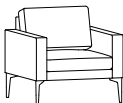
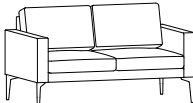
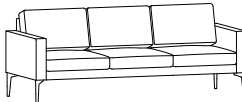
MODEL NUMBER	PRODUCT SPECIFICATIONS	FABRIC GRADES							LEATHER GRADES				
		COM	1	2	COL			4	5	6	7	8	L1
5101-4LR 	Q S Lounge Chair, 4" Arms W 33 D 31 ³ / ₄ H 31 Seat Height 17 ¹ / ₄ Inside Seat Width 25 Inside Seat Depth 22 6 ¹ / ₂ yds. COL 130 sq. ft. 65 lbs. TB 133, add \$312 List	1754	2123	2212	2369	2526	2676	2833	2976	3133	3850	4375	4887
5102-4LR 	Love Seat, 4" Arms W 58 D 31 ³ / ₄ H 31 Seat Height 17 ¹ / ₄ Inside Seat Width 50 Inside Seat Depth 22 8 ³ / ₄ yds. COL 175 sq. ft. 95 lbs. TB 133, add \$420 List	2358	2855	2974	3185	3397	3599	3810	4003	4214	5179	5886	6576
5103-4LR 	Sofa, 4" Arms W 83 D 31 ³ / ₄ H 31 Seat Height 17 ¹ / ₄ Inside Seat Width 75 Inside Seat Depth 22 12 yds. COL 240 sq. ft. 120 lbs. TB 133, add \$576 List	2983	3664	3828	4117	4407	4684	4974	5239	5529	6852	7822	8767

OPTIONS (XXXX - REFERS TO CHAIR MODEL NUMBER)

MODEL	DESCRIPTION	LIST
XXXX-WC01	4" Wood Arm Cap, Per Unit	604
XXXX-CO04	4" Corian Arm Cap, Per Unit	300
XXXX-WT01	Wood Trim - Lounge Chair	272
XXXX-WT02	Wood Trim - Love Seat	380
XXXX-WT03	Wood Trim - Sofa	464
XXXX-TSB01	Tufted Stitch Detail, Back Cushion (per cushion)	95
XXXX-TSS01	Tufted Stitch Detail, Seat Cushion (per cushion)	120
XXXX-NS02B	Non-Skid Glides	20
XXXX-PF04	Premium Leg Finish	135
XXXX-PB1-S	Power Band 1 (one power, two USB), Silver	413
XXXX-PB1-W	Power Band 1 (one power, two USB), White	413
XXXX-PB2-S	Power Band 2 (dual power), Silver	322
XXXX-PB2-W	Power Band 2 (dual power), White	322
GC06 (ordered separately)	Ganging Connector	75

Q S = Available on Quick-SHIP Program (standard finishes only).

UPTOWN SOCIAL LOUNGE-MODULAR

designed by chris and jon panichella

NOTES:

- Models with 7" wide arms.
- Available individually or in modular combinations.
- **For modular arrangements, a layout drawing or sketch must accompany each order.**
- Optional arm cap offered in Walnut or White Oak, as well as Corian.
- Metal legs available in standard and premium finishes.
- Refer to pages 18-20 for two-tone upholstery examples and yardage requirements.

SPECIFY:

1. Model number
2. Leg finish
3. Upholstery selection
4. Options, as applicable

ORDERING EXAMPLE:

#5101-7LR-PB1-W

Lounge Chair
Power Band 1 Unit, White

SIN #711-16

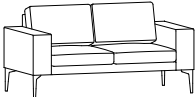
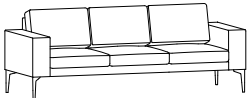
MODEL NUMBER	PRODUCT SPECIFICATIONS	FABRIC GRADES							LEATHER GRADES				
		COM	1	2	COL 3	4	5	6	7	8	L1	L2	L3
5101-7LR 	Lounge Chair, 7" Arms W 39 D 31 ³ / ₄ H 31 Seat Height 17 ¹ / ₄ Inside Seat Width 25 Inside Seat Depth 22 6 ¹ / ₂ yds. COL 130 sq. ft. 75 lbs. TB 133, add \$312 List	1798	2167	2256	2413	2570	2720	2877	3020	3177	3894	4419	4931
5102-7LR 	Love Seat, 7" Arms W 64 D 31 ³ / ₄ H 31 Seat Height 17 ¹ / ₄ Inside Seat Width 50 Inside Seat Depth 22 8 ³ / ₄ yds. COL 175 sq. ft. 105 lbs. TB 133, add \$420 List	2402	2899	3018	3229	3441	3643	3854	4047	4258	5223	5930	6620
5103-7LR 	Sofa, 7" Arms W 89 D 31 ³ / ₄ H 31 Seat Height 17 ¹ / ₄ Inside Seat Width 75 Inside Seat Depth 22 12 yds. COL 240 sq. ft. 130 lbs. TB 133, add \$576 List	3027	3708	3872	4161	4451	4728	5018	5283	5573	6896	7866	8811

OPTIONS (XXXX - REFERS TO CHAIR MODEL NUMBER)

MODEL	DESCRIPTION	LIST
XXXX-WC02	7" Wood Arm Cap, Per Unit	666
XXXX-CO05	7" Corian Arm Cap, Per Unit	400
XXXX-WT01	Wood Trim - Lounge Chair	272
XXXX-WT02	Wood Trim - Love Seat & Chaise Lounge	380
XXXX-WT03	Wood Trim - Sofa	464
XXXX-TSB01	Tufted Stitch Detail, Back Cushion (per cushion)	95
XXXX-TSS01	Tufted Stitch Detail, Seat Cushion (per cushion)	120
XXXX-NS02B	Non-Skid Glides	20
XXXX-PF04	Premium Leg Finish	135
XXXX-PB1-S	Power Band 1 (one power, two USB), Silver	413
XXXX-PB1-W	Power Band 1 (one power, two USB), White	413
XXXX-PB2-S	Power Band 2 (dual power), Silver	322
XXXX-PB2-W	Power Band 2 (dual power), White	322
GC06 (ordered separately)	Ganging Connector	75

Q S = Available on Quick-Ship Program (standard finishes only).

NOTES:

- Available individually or in modular combinations.
- Integrated table available in Walnut or White Oak veneer, laminate and Corian selections.
- Metal legs available in standard and premium finishes.
- Refer to pages 18-20 for two-tone upholstery examples and yardage requirements.

SPECIFY:

1. Model number
2. Table finish, as applicable
3. Leg finish
4. Upholstery selection
5. Options, as applicable

ORDERING EXAMPLE:

#5111-BL-WT02-PF04

Single Seat with Bench
Wood Trim
Premium Leg Finish

UPTOWN SOCIAL
LOUNGE-MODULAR

designed by chris and jon panichella

SIN #711-16

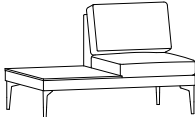
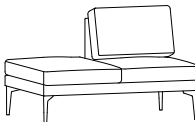
MODEL NUMBER	PRODUCT SPECIFICATIONS	FABRIC GRADES							LEATHER GRADES				
		COM	1	2	COL 3	4	5	6	7	8	L1	L2	L3
5104 	Corner Unit W 31 D 31 H 31 Seat Height 17 ¹ / ₄ Inside Seat Width 24 ¹ / ₂ Inside Seat Depth 24 ¹ / ₂ 5 ¹ / ₂ yds. COL 110 sq. ft. 52 lbs. TB 133, add \$264 List	1502	1814	1889	2022	2155	2282	2415	2536	2669	3275	3720	4153
5111-TL (TABLE LEFT) 5111-TR (TABLE RIGHT) 	Single Seat Lounge with Table (specify placement as seated) W 50 D 31 ³ / ₄ H 31 Seat Height 17 ¹ / ₄ Inside Seat Width 25 Inside Seat Depth 22 3 ¹ / ₂ yds. COL 70 sq. ft. 56 lbs. TB 133, add \$168 List	2122	2321	2369	2453	2538	2619	2703	2780	2865	3251	3534	3809
5111-BL (BENCH LEFT) 5111-BR (BENCH RIGHT) 	Single Seat Lounge with Bench (specify placement as seated) W 50 D 31 ³ / ₄ H 31 Seat Height 17 ¹ / ₄ Inside Seat Width 25 Inside Seat Depth 22 5 yds. COL 100 sq. ft. 56 lbs. TB 133, add \$240 List	1757	2041	2109	2230	2351	2466	2587	2697	2818	3369	3773	4167

To add single arms, please refer to page 9

OPTIONS (XXXX - REFERS TO CHAIR MODEL NUMBER)

MODEL	DESCRIPTION	LIST
XXXX-WT01	Wood Trim, Corner Unit	272
XXXX-WT02	Wood Trim, #5111 Models	380
XXXX-TSB01	Tufted Stitch Detail, Back Cushion, Single Seat Lounge Units	95
XXXX-TSB02	Tufted Stitch Detail, Back Cushion, Corner Unit	140
XXXX-TSS01	Tufted Stitch Detail, Seat Cushion (per cushion)	120
XXXX-CO	Corian Top - Model #5111TL/TR	1035
XXXX-NS02B	Non-Skid Glides	20
XXXX-PF04	Premium Leg Finish	135
Table Power Units		
XXXX-PB1-S	Power Band 1 (one power, two USB), Silver	413
XXXX-PB1-W	Power Band 1 (one power, two USB), White	413
XXXX-PB2-S	Power Band 2 (dual power), Silver	322
XXXX-PB2-W	Power Band 2 (dual power), White	322
XXXX-PB3-S	Power Band 3 (dual power, two USB), Silver	429
XXXX-PB3-W	Power Band 3 (dual power, two USB), White	429
GC06 (ordered separately)	Ganging Connector	75

UPTOWN SOCIAL LOUNGE-MODULAR

designed by chris and jon panichella

NOTES:

- Available individually or in modular combinations.
- Table available in Walnut or White Oak veneer, laminate and Corian selections.
- Metal legs available in standard and premium finishes.
- Refer to pages 18-20 for two-tone upholstery examples and yardage requirements.

SPECIFY:

1. Model number
2. Table finish, as applicable
3. Leg finish
4. Upholstery selection
5. Options, as applicable

ORDERING EXAMPLE:

#5112-TL-PB2-S-PF04
Two-Seat Lounge with Table
Power Band 2 Unit, Silver
Premium Leg Finish

SIN #711-16

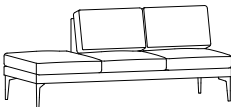
MODEL NUMBER	PRODUCT SPECIFICATIONS	FABRIC GRADES							LEATHER GRADES							
		COM	1	2	COL			3	4	5	6	7	8	L1	L2	L3
5112-TL (TABLE LEFT) 5112-TR (TABLE RIGHT) 	Two-Seat Lounge with Table (specify placement as seated) W 75 D 31 ³ / ₄ H 31 Seat Height 17 ¹ / ₄ Inside Seat Width 75 Inside Seat Depth 22 6 ¹ / ₂ yds. COL 130 sq. ft. 90 lbs. TB 133, add \$312 List	2673	3042	3131	3288	3445	3595	3752	3895	4052	4769	5294	5806			
5112-BL (BENCH LEFT) 5112-BR (BENCH RIGHT) 	Two-Seat Lounge with Bench (specify placement as seated) W 75 D 31 ³ / ₄ H 31 Seat Height 17 ¹ / ₄ Inside Seat Width 75 Inside Seat Depth 22 7 ³ / ₄ yds. COL 155 sq. ft. 90 lbs. TB 133, add \$372 List To add single arms, please refer to page 9	2314	2754	2860	3047	3234	3413	3600	3771	3958	4813	5439	6050			

OPTIONS (XXXX - REFERS TO CHAIR MODEL NUMBER)

MODEL	DESCRIPTION	LIST
XXXX-WT03	Wood Trim	464
XXXX-TSB01	Tufted Stitch Detail, Back Cushion (per cushion)	95
XXXX-TSS01	Tufted Stitch Detail, Seat Cushion (per cushion)	120
XXXX-CO	Corian Top - Model #5112TL/TR	1035
XXXX-NS02B	Non-Skid Glides	20
XXXX-PF04	Premium Leg Finish	135
Table Power Units		
XXXX-PB1-S	Power Band 1 (one power, two USB), Silver	413
XXXX-PB1-W	Power Band 1 (one power, two USB), White	413
XXXX-PB2-S	Power Band 2 (dual power), Silver	322
XXXX-PB2-W	Power Band 2 (dual power), White	322
XXXX-PB3-S	Power Band 3 (dual power, two USB), Silver	429
XXXX-PB3-W	Power Band 3 (dual power, two USB), White	429
GC06 (ordered separately)	Ganging Connector	75

NOTES:

- Specify arm model number after applicable seating unit.
- Optional arm cap offered in Walnut or White Oak, as well as Corian.
- Power units available on front or side of arm, please specify location.

SPECIFY:

1. Model number
2. Upholstery selection
3. Options, as applicable

ORDERING EXAMPLE:

#5102-7LA-C005

Armless Love Seat with 7" Arm,
Left Side as seated
Corian Arm Cap

**UPTOWN SOCIAL
LOUNGE-MODULAR**

designed by chris and jon panichella

SIN #711-16

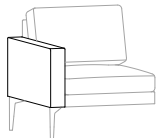
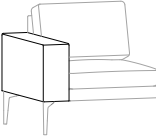
MODEL NUMBER	PRODUCT SPECIFICATIONS	FABRIC GRADES									LEATHER GRADES		
		COM	1	2	COL			6	7	8	L1	L2	L3
XXXX-4LA (LEFT ARM) XXXX-4RA (RIGHT ARM)	4" End Arm, specify placement as seated 1 1/2 yds. COL 30 sq. ft. 12 lbs. TB 133, add \$72 List	235	321	341	377	413	448	484	517	554	719	840	958
													
XXXX-7LA (LEFT ARM) XXXX-7RA (RIGHT ARM)	7" End Arm, specify placement as seated 1 1/2 yds. COL 30 sq. ft. 17 lbs. TB 133, add \$72 List	257	343	363	399	435	470	506	539	576	741	862	980
													

OPTIONS (XXXX - REFERS TO ARM MODEL NUMBER)

MODEL	DESCRIPTION	LIST
XXXX-WC01	4" Wood Arm Cap, Per Arm	302
XXXX-CO04	4" Corian Arm Cap, Per Arm	150
XXXX-WC02	7" Wood Arm Cap, Per Arm	333
XXXX-CO05	7" Corian Arm Cap, Per Arm	200
XXXX-PB1-S	Power Band 1 (one power, two USB), Silver	413
XXXX-PB1-W	Power Band 1 (one power, two USB), White	413
XXXX-PB2-S	Power Band 2 (dual power), Silver	322
XXXX-PB2-W	Power Band 2 (dual power), White	322

UPTOWN SOCIAL LOUNGE-MODULAR

designed by chris and jon panichella

NOTES:

- Veneer, laminate or Corian top with upholstered body.
- Veneer available in Walnut and White Oak, in all standard and custom wood finishes.
- Tables will always have four (4) legs can be adjoined to other models via the ganging connector for more permanent connections.
- Metal legs available in standard and premium finishes.

SPECIFY:



1. Model number
2. Table top finish
3. Leg finish
4. Upholstery selection
5. Options, as applicable

ORDERING EXAMPLE:

#5115-3131-U-WT01

31" Wide Connecting Table
Wood Trim

SIN #711-16

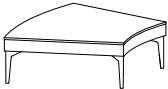
MODEL NUMBER	PRODUCT SPECIFICATIONS	FABRIC GRADES							LEATHER GRADES			
		COM	1	2	COL			8	L1	L2	L3	
 <p>5115-2531-U 25" Wide Table, Wood Top with Upholstered Body W 25 D 31 H 12¹/₄ 3/4 yd. COL 15 sq. ft. 29 lbs. TB 133, add \$36 List</p>	1039	1082	1092	1110	1128	1146	1164	1180	1199	1281	1342	1401
 <p>5115-3131-U 31" Wide Table, Wood Top with Upholstered Body W 31 D 31 H 12¹/₄ 1 yd. COL 20 sq. ft. 31 lbs. TB 133, add \$48 List</p>	1223	1280	1294	1318	1342	1365	1389	1411	1436	1546	1627	1705
 <p>5116-U 30-Degree Table, Wood Top with Upholstered Body W 31 D 31 H 12¹/₄ 1 yd. COL 20 sq. ft. 30 lbs. TB 133, add \$48 List</p>	1155	1212	1226	1250	1274	1297	1321	1343	1368	1478	1559	1637

OPTIONS (XXXX - REFERS TO TABLE MODEL NUMBER)

MODEL	DESCRIPTION	LIST
XXXX-WT01	Wood Trim	272
XXXX-CO	Corian Top, 25" Wide Table	698
XXXX-CO	Corian Top, 31" Wide Table	1035
XXXX-CO	Corian Top, 30-Degree Table	1492
XXXX-NS02B	Non-Skid Glides	20
XXXX-PF04	Premium Leg Finish	135
XXXX-PB1-S	Power Band 1 (one power, two USB), Silver	413
XXXX-PB1-W	Power Band 1 (one power, two USB), White	413
XXXX-PB2-S	Power Band 2 (dual power), Silver	322
XXXX-PB2-W	Power Band 2 (dual power), White	322
XXXX-PB3-S	Power Band 3 (dual power, two USB), Silver	429
XXXX-PB3-W	Power Band 3 (dual power, two USB), White	429
GC06 (ordered separately)	Ganging Connector	75

NOTES:

- All veneer, all laminate or Corian top with veneer or laminate body.
- Veneer available in Walnut and White Oak, in all standard and custom wood finishes.
- Tables will always have four (4) legs can be adjoined to other models via the ganging connector for more permanent connections.
- Metal legs available in standard and premium finishes.

SPECIFY:

1. Model number
2. Table top finish
3. Leg finish
4. Options, as applicable



ORDERING EXAMPLE:

#5115-2531-W-CO-NS02B
 25" Wide Connecting Table
 Corian Top
 Non-Skid Glides

**UPTOWN SOCIAL
 LOUNGE-MODULAR**

designed by chris and jon panichella

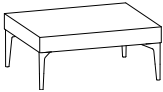
SIN #711-16

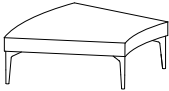
MODEL NUMBER	PRODUCT SPECIFICATIONS	TABLE TOP FINISH	
		VENEER OR LAMINATE	CORIAN (-CO)
5115-2531-W 	25" Wide Table, Wood Top & Body W 25 D 31 H 12 ¹ / ₄	1195	2030
5115-3131-W 	31" Wide Table, Wood Top & Body W 31 D 31 H 12 ¹ / ₄ TB 133, add \$XX List	1345	2380
5116-W 	30-Degree Table, Wood Top & Body W 31 D 31 H 12 ¹ / ₄ XX yds. COL XXX sq. ft. 35 lbs. TB 133, add \$XX List	1345	2837

OPTIONS (XXXX - REFERS TO TABLE MODEL NUMBER)

MODEL	DESCRIPTION	LIST
XXXX-WT01	Wood Trim	272
XXXX-NS02B	Non-Skid Glides	20
XXXX-PF04	Premium Leg Finish	135
XXXX-PB1-S	Power Band 1 (one power, two USB), Silver	413
XXXX-PB1-W	Power Band 1 (one power, two USB), White	413
XXXX-PB2-S	Power Band 2 (dual power), Silver	322
XXXX-PB2-W	Power Band 2 (dual power), White	322
XXXX-PB3-S	Power Band 3 (dual power, two USB), Silver	429
XXXX-PB3-W	Power Band 3 (dual power, two USB), White	429
GC06 (ordered separately)	Ganging Connector	75

UPTOWN SOCIAL LOUNGE-MODULAR

designed by chris and jon panichella

NOTES:

- Center table available in Walnut or White Oak veneer, laminate and Corian selections.
- Metal legs available in standard and premium finishes.
- Refer to page 19 for two-tone upholstery examples and yardage requirements.

SPECIFY:

- Model number
- Table finish, as applicable
- Leg finish
- Upholstery selection
- Options, as applicable

ORDERING EXAMPLE:

#5124-WT03-PF04
Two-Seat Bench w/Center Table
Wood Trim Detail
Premium Leg Finish

SIN #711-16

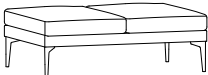
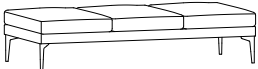
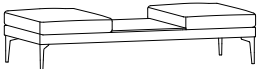
MODEL NUMBER	PRODUCT SPECIFICATIONS	FABRIC GRADES							LEATHER GRADES							
		COM	1	2	COL			3	4	5	6	7	8	L1	L2	L3
5121 	Single Seat Modular Bench W 25 D 31 ³ / ₄ H 17 ¹ / ₄ 2 yds. 30 lbs. COL 40 Sq. Ft. TB 133, add \$96 List	1056	1170	1197	1245	1294	1340	1388	1432	1481	1701	1863	2020			
5122 	Two-Seat Modular Bench W 50 D 31 ³ / ₄ H 17 ¹ / ₄ 3 ¹ / ₂ yds. 49 lbs. COL 70 Sq. Ft. TB 133, add \$168 List	1289	1488	1536	1620	1705	1786	1870	1947	2032	2418	2701	2976			
5123 	Three-Seat Modular Bench W 75 D 31 ³ / ₄ H 17 ¹ / ₄ 5 ¹ / ₄ yds. 83 lbs. COL 105 Sq. Ft. TB 133, add \$252 List	1641	1939	2011	2138	2264	2386	2512	2628	2755	3334	3758	4172			
5124 	Two-Seat Modular Bench with Integrated Center Table W 75 D 31 ³ / ₄ H 17 ¹ / ₄ 3 ³ / ₄ yds. 78 lbs. COL 75 Sq. Ft. TB 133, add \$180 List	1812	2025	2076	2167	2257	2344	2435	2517	2608	3021	3324	3620			

OPTIONS (XXXX - REFERS TO BENCH MODEL NUMBER)

MODEL	DESCRIPTION	LIST
XXXX-WT01	Wood Trim - Model #5121	272
XXXX-WT02	Wood Trim - Model #5122	380
XXXX-WT03	Wood Trim - Models #5123 & #5124	464
XXXX-TSS01	Tufted Stitch Detail, Seat Cushion (per cushion)	120
XXXX-CO	Corian Top - Model #5124	835
XXXX-NS02B	Non-Skid Glides	20
XXXX-PF04	Premium Leg Finish	135
Table Power Units		
XXXX-PB1-S	Power Band 1 (one power, two USB), Silver	413
XXXX-PB1-W	Power Band 1 (one power, two USB), White	413
XXXX-PB2-S	Power Band 2 (dual power), Silver	322
XXXX-PB2-W	Power Band 2 (dual power), White	322
XXXX-PB3-S	Power Band 3 (dual power, two USB), Silver	429
XXXX-PB3-W	Power Band 3 (dual power, two USB), White	429
GC06 (ordered separately)	Ganging Connector	75

NOTES:

- Table available in Walnut or White Oak veneer, laminate and Corian selections.
- Metal legs available in standard and premium finishes.
- Refer to page 19 for two-tone upholstery examples and yardage requirements.

SPECIFY:

1. Model number
2. Table finish, as applicable
3. Leg finish
4. Upholstery selection
5. Options, as applicable



ORDERING EXAMPLE:

#5113-TL-CO-PF04
 60-Degree Bench/Table
 Corian Table Top
 Premium Leg Finish

**UPTOWN SOCIAL
 LOUNGE-MODULAR**

designed by chris and jon panichella

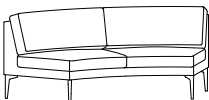
SIN #711-16

MODEL NUMBER	PRODUCT SPECIFICATIONS	FABRIC GRADES							LEATHER GRADES				
		COM	1	2	COL 3	4	5	6	7	8	L1	L2	L3
5106 	30-Degree Single Seat W 41 D 31 ³ / ₄ H 31 Seat Height 17 ¹ / ₄ Inside Seat Width 25 Inside Seat Depth 22 4 ³ / ₄ yds. COL 95 sq. ft. 48 lbs. TB 133, add \$228 List	1452	1722	1787	1901	2016	2126	2241	2345	2460	2984	3368	3742
5107 	60-Degree 2-Seat W 79 D 31 ³ / ₄ H 31 Seat Height 17 ¹ / ₄ Inside Seat Width 48 Inside Seat Depth 22 10 ³ / ₄ yds. COL 215 sq. ft. 69 lbs. TB 133, add \$516 List	2107	2717	2864	3123	3383	3631	3891	4128	4388	5573	6442	7288
5113-TL (TABLE LEFT) 5113-TR (TABLE RIGHT) 	60-Degree Single Seat with Table (specify placement as seated) W 79 D 31 ³ / ₄ H 31 Seat Height 17 ¹ / ₄ Inside Seat Width 25 Inside Seat Depth 22 4 ³ / ₄ yds. COL 95 sq. ft. 64 lbs. TB 133, add \$228 List	2422	2692	2757	2871	2986	3096	3211	3315	3430	3954	4338	4712
5113-BL (BENCH LEFT) 5113-BR (BENCH RIGHT) 	60-Degree Single Seat with Bench (specify placement as seated) W 79 D 31 ³ / ₄ H 31 Seat Height 17 ¹ / ₄ Inside Seat Width 25 Inside Seat Depth 22 7 ¹ / ₂ yds. COL 150 sq. ft. 64 lbs. TB 133, add \$360 List	2073	2499	2601	2782	2963	3137	3318	3483	3664	4491	5097	5688
To add single arms, please refer to page 9													

OPTIONS (XXXX - REFERS TO CHAIR MODEL NUMBER)

MODEL	DESCRIPTION	LIST
XXXX-WT01	Wood Trim - Model #5106	272
XXXX-WT02	Wood Trim - Model #5107 and #5113's	380
XXXX-TSB01	Tufted Stitch Detail, Back Cushion (per cushion)	95
XXXX-TSS01	Tufted Stitch Detail, Seat Cushion (per cushion)	120
XXXX-CO	Corian Table Top	1369
XXXX-NS02B	Non-Skid Glides	20
XXXX-PF04	Premium Leg Finish	135
GC06 (ordered separately)	Ganging Connector	75

Table power units - refer to page 12

UPTOWN SOCIAL LOUNGE-MODULAR

designed by chris and jon panichella

NOTES:

- Table available in Walnut or White Oak veneer, laminate and Corian selections.
- Metal legs available in standard and premium finishes.
- Refer to page 19 for two-tone upholstery examples and yardage requirements.

SPECIFY:

1. Model number
2. Table finish, as applicable
3. Leg finish
4. Upholstery selection
5. Options, as applicable

ORDERING EXAMPLE:

#5114-TR-PB1-W
60-Degree Bench/Table
Power Band 1, White

SIN #711-16

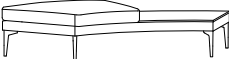
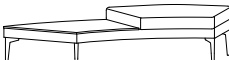
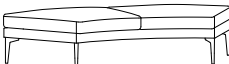
MODEL NUMBER	PRODUCT SPECIFICATIONS	FABRIC GRADES							LEATHER GRADES				
		COM	1	2	COL			8	L1	L2	L3		
5126 	30-Degree Single Seat Bench W 41 ¹ / ₂ D 32 H 17 ¹ / ₄ 3 ³ / ₄ yds. 41 lbs. COL 75 Sq. Ft. TB 133, add \$180 List	1182	1395	1446	1537	1627	1714	1805	1887	1978	2391	2694	2990
5114-TL 	60-Degree Bench/Table Combination Table Left, As Seated W 79 D 31 ³ / ₄ H 17 ¹ / ₄ 4 ¹ / ₂ yds. 52 lbs. COL 90 Sq. Ft. TB 133, add \$216 List	2145	2401	2462	2571	2679	2783	2892	2991	3100	3596	3960	4314
5114-TR 	60-Degree Bench/Table Combination Table Right, As Seated W 79 D 31 ³ / ₄ H 17 ¹ / ₄ 4 ¹ / ₂ yds. 52 lbs. COL 90 Sq. Ft. TB 133, add \$216 List	2145	2401	2462	2571	2679	2783	2892	2991	3100	3596	3960	4314
5127 	60-Degree 2-Seat Bench W 79 D 31 ³ / ₄ H 17 ¹ / ₄ 7 ¹ / ₂ yds. 57 lbs. COL 150 Sq. Ft. TB 133, add \$360 List	1477	1903	2005	2186	2367	2541	2722	2887	3068	3895	4501	5092

OPTIONS (XXXX - REFERS TO BENCH MODEL NUMBER)

MODEL	DESCRIPTION	LIST
XXXX-WT01	Wood Trim - Model #5126	272
XXXX-WT02	Wood Trim - Models #5114 & 5127	380
XXXX-TSS01	Tufted Stitch Detail, Seat Cushion (per cushion)	120
XXXX-CO	Corian Table Top	1369
XXXX-NS02B	Non-Skid Glides	20
XXXX-PF04	Premium Leg Finish	135
Table Power Units		
XXXX-PB1-S	Power Band 1 (one power, two USB), Silver	413
XXXX-PB1-W	Power Band 1 (one power, two USB), White	413
XXXX-PB2-S	Power Band 2 (dual power), Silver	322
XXXX-PB2-W	Power Band 2 (dual power), White	322
XXXX-PB3-S	Power Band 3 (dual power, two USB), Silver	429
XXXX-PB3-W	Power Band 3 (dual power, two USB), White	429
GC06 (ordered separately)	Ganging Connector	75

NOTES:

- Upholstered on both sides, with concealed zipper enclosure.

SPECIFY:

- Model number
- Upholstery selection

ORDERING EXAMPLE:

#5118-1616
16" Square Pillow

UPTOWN SOCIAL
LOUNGE-MODULAR

designed by chris and jon panichella

SIN #711-16

MODEL NUMBER	PRODUCT SPECIFICATIONS	FABRIC GRADES								LEATHER GRADES			
		COM	1	2	COL			6	7	8	L1	L2	L3
5118-1616	16" Square Pillow W 16 D 3 H 16 3/4 yd. COL 15 sq. ft. 1 lb. TB 133, add \$36 List	109	152	162	180	198	216	234	250	269	351	412	471
5118-1818	18" Square Pillow W 18 D 3 H 18 3/4 yd. COL 15 sq. ft. 1 lb. TB 133, add \$36 List	113	156	166	184	202	220	238	254	273	355	416	475
5118-2020	20" Square Pillow W 20 D 3 H 20 3/4 yd. COL 15 sq. ft. 1 lb. TB 133, add \$36 List	117	160	170	188	206	224	242	258	277	359	420	479
5118-1018	10" x 18" Rectangle Pillow W 18 D 3 H 12 1/2 yd. COL 10 sq. ft. 1 lb. TB 133, add \$24 List	111	140	147	159	171	182	194	205	218	273	313	352
5119	6" x 18" Bolster Pillow W 18 D 3 H 12 3/4 yd. COL 15 sq. ft. 1 lb. TB 133, add \$36 List	142	185	195	213	231	249	267	283	302	384	445	504

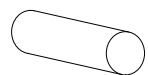
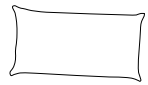

UPTOWN SOCIAL LOUNGE-MODULAR

designed by chris and jon panichella

NOTES:

- Pull-up table top available in veneer, laminate or Corian.
- Standard and premium base finish options.

SPECIFY:

1. Model number
2. Table Top Finish
3. Base Finish
4. Options, as applicable

ORDERING EXAMPLE:

#5140-CO-PF04

Pull-Up Table, Corian Top
Premium Base Finish

SIN #711-16

MODEL NUMBER	PRODUCT SPECIFICATIONS	TABLE TOP FINISH	
		VENEER OR LAMINATE	CORIAN (-CO)
5140	 <p>Q S Pull-Up Table, Rectangle Top Overall Dimensions: 18" W x 12" D x 26" H ³/₄" Table Top Thickness 25 lbs.</p>	921	1124

OPTIONS (XXXX - REFERS TO TABLE MODEL NUMBER)

MODEL	DESCRIPTION	LIST
XXXX-PF04	Premium Finish	135

Q S = Available on Quick-Ship Program (standard finishes only).

UPTOWN SOCIAL LOUNGE-MODULAR

designed by chris and jon panichella



SIN #711-16

CONFIGURATION AND ORDERING EXAMPLES

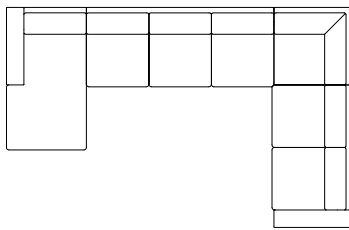

Qty	Model #	Description	COM List
1	5102-4LA	Love Seat, Left Arm (as seated)	2,123
1	5104	Corner Unit	1,502
1	5103	Armless Sofa	2,513
<u>1</u>	<u>5105-4RA</u>	<u>Chaise Lounge, Right Arm (as seated)</u>	<u>2,068</u>
4			8,206

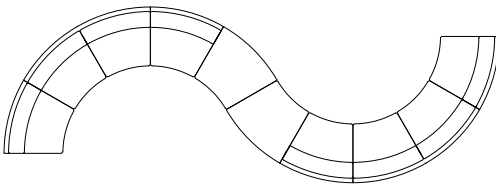

Qty	Model #	Description	COM List
2	5106	30-Degree Single Seat, Armless (\$1,452 each)	2,904
2	5107	60-Degree Two-Seat, Armless (\$2,107 each)	4,214
<u>2</u>	<u>5113-TL</u>	<u>60-Degree Lounge/Table Combination (\$2,422 each)</u>	<u>4,844</u>
6			11,962

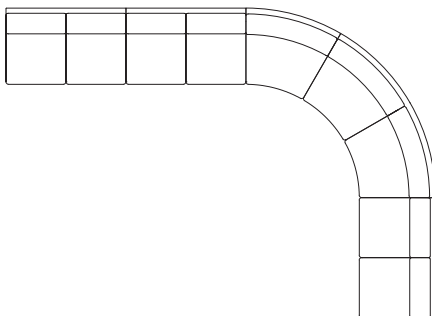

Qty	Model #	Description	COM List
3	5102	Armless Love Seat (\$1,888 each)	5,664
1	5107	60-Degree Two-Seat, Armless	2,107
<u>1</u>	<u>5106</u>	<u>30-Degree Single Seat, Armless</u>	<u>1,452</u>
5			9,223

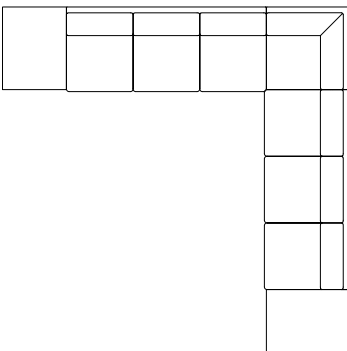

Qty	Model #	Description	COM List
2	5115-2531-W	25" Wide Tables (\$1,195 each)	2,390
2	5103	Armless Sofa (\$2,513 each)	5,026
<u>1</u>	<u>5104</u>	<u>Corner Unit</u>	<u>1,502</u>
5			8,918

UPTOWN SOCIAL LOUNGE-MODULAR

designed by chris and jon panichella

UPHOLSTERY COMBINATIONS:

For fabric, vinyl or leather upholstery combinations, refer to the pricing below:

- When combining **two** COM/COV/COL fabrics, or fabrics with the same grade, add the following (per unit):
 - › \$65 List for lounge chairs and single seat benches
 - › \$105 List for love seats, chaise lounge and 2-seat units
 - › \$130 List for sofas
- When combining **three or more** COM/COV/COL fabrics, or fabrics with the same grade, add the following (per unit):
 - › \$75 List for lounge chairs and single seat benches

- › \$115 List for love seats, chaise lounge and 2-seat units
- › \$140 List for sofas

- When combining different grades of fabric, price will be based on the highest grade specified.
- Two-tone upholstery examples and yardage requirements for the most common combinations are listed below. Additional combinations available, please contact Customer Service for yardage requirements and pricing.
- Note: Yardage amounts are based on fabric which is plain (i.e. non-directional) and a full 54" wide.
- **Appropriate upholstery code must be included on order.**

SIN #711-16



Code US1
Model COM Requirement
 5101 Seat Cushion Only = 1³/₄ yds.
 Balance of Chair = 2¹/₂ yds.

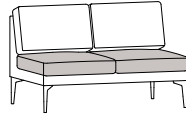

Code US2
Model COM Requirement
 5102 Seat Cushion Only = 2¹/₂ yds.
 Balance of Chair = 3³/₄ yds.

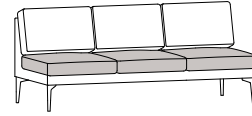

Code US3
Model COM Requirement
 5103 Seat Cushion Only = 3³/₄ yds.
 Balance of Chair = 5¹/₂ yds.



Code US4
Model COM Requirement
 5105 Seat Cushion Only = 2¹/₂ yds.
 Balance of Chair = 2¹/₂ yds.



Code US5
Model COM Requirement
 5101-4LR Seat Cushion Only = 1³/₄ yds.
 Balance of Chair = 4 yds.

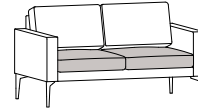

Code US6
Model COM Requirement
 5102-4LR Seat Cushion Only = 2¹/₂ yds.
 Balance of Chair = 5¹/₄ yds.

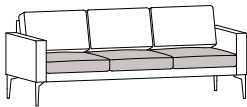

Code US7
Model COM Requirement
 5103-4LR Seat Cushion Only = 3³/₄ yds.
 Balance of Chair = 7 yds.

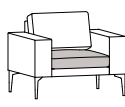

Code US8
Model COM Requirement
 5101-7LR Seat Cushion Only = 1³/₄ yds.
 Balance of Chair = 4 yds.

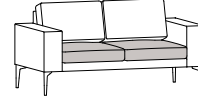

Code US9
Model COM Requirement
 5102-7LR Seat Cushion Only = 2¹/₂ yds.
 Balance of Chair = 5¹/₄ yds.

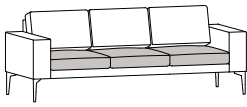

Code US10
Model COM Requirement
 5103-7LR Seat Cushion Only = 3³/₄ yds.
 Balance of Chair = 7 yds.



Code US11
Model COM Requirement
 5104 Seat Cushion Only = 1¹/₂ yds.
 Balance of Chair = 4¹/₄ yds.

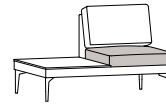

Code US12
Model COM Requirement
 5111-TL Seat Cushion Only = 1³/₄ yds.
 5111-TR Balance of Chair = 2³/₄ yds.

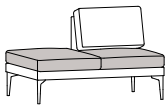

Code US13
Model COM Requirement
 5111-BL Seat Cushion Only = 3 yds.
 5111-BR Balance of Chair = 2³/₄ yds.

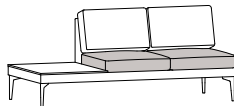

Code US14
Model COM Requirement
 5112-TL Seat Cushion Only = 2¹/₂ yds.
 5112-TR Balance of Chair = 4¹/₄ yds.

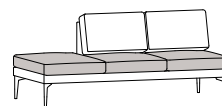

Code US15
Models COM Requirement
 5112-BR Seat Cushion Only = 3³/₄ yds.
 5112-BL Balance of Chair = 4¹/₂ yds.

UPHOLSTERY COMBINATIONS:

For fabric, vinyl or leather upholstery combinations, refer to the pricing below:

- When combining **two** COM/COV/COL fabrics, or fabrics with the same grade, add the following (per unit):
 - › \$65 List for lounge chairs and single seat benches
 - › \$105 List for love seats, chaise lounge and 2-seat units
 - › \$130 List for sofas
- When combining **three or more** COM/COV/COL fabrics, or fabrics with the same grade, add the following (per unit):
 - › \$75 List for lounge chairs and single seat benches

› \$115 List for love seats, chaise lounge and 2-seat units

› \$140 List for sofas

- When combining different grades of fabric, price will be based on the highest grade specified.
- Two-tone upholstery examples and yardage requirements for the most common combinations are listed below. Additional combinations available, please contact Customer Service for yardage requirements and pricing.
- Note: Yardage amounts are based on fabric which is plain (i.e. non-directional) and a full 54" wide.
- **Appropriate upholstery code must be included on order.**

UPTOWN SOCIAL
LOUNGE-MODULAR

designed by chris and jon panichella

SIN #711-16



Code US16
Model COM Requirement
5121 Seat Cushion Only = 1¹/₂ yds.
Balance of Chair = 1 yd.

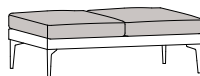

Code US17
Model COM Requirement
5122 Seat Cushion Only = 3 yds.
Balance of Chair = 1¹/₄ yds.

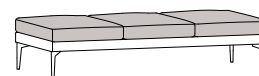

Code US18
Models COM Requirement
5123 Seat Cushion Only = 4¹/₄ yds.
Balance of Chair = 1¹/₂ yds.

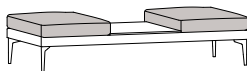

Code US19
Model COM Requirement
5124 Seat Cushion Only = 3 yds.
Balance of Chair = 1¹/₂ yds.



Code US20
Model COM Requirement
5106 Seat Cushion Only = 2¹/₄ yds.
Balance of Chair = 3¹/₄ yds.

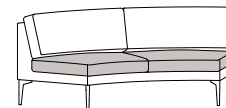

Code US21
Models COM Requirement
5107 Seat Cushion Only = 4¹/₄ yds.
Balance of Chair = 6³/₄ yds.

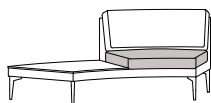

Code US22
Model COM Requirement
5113-TL Seat Cushion Only = 3³/₄ yds.
5113-TR Balance of Chair = 2 yds.

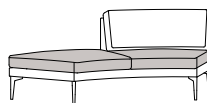

Code US23
Model COM Requirement
5113-BL Seat Cushion Only = 4¹/₂ yds.
5113-BR Balance of Chair = 3³/₄ yds.

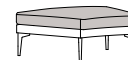

Code US24
Model COM Requirement
5126 Seat Cushion Only = 3 yds.
Balance of Bench = 1¹/₄ yds.

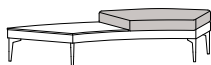

Code US25
Model COM Requirement
5114-TL Seat Cushion = 3 yds.
5114-TR Balance of Bench = 1¹/₂ yds.

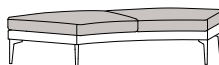

Code US26
Model COM Requirement
5127 Seat Cushion = 6¹/₄ yds.
Balance of Bench = 1¹/₂ yds.

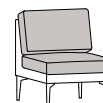

Code US27
Model COM Requirement
5101 Back & Seat Cushion = 2¹/₂ yds.
Balance of Chair = 2 yds.

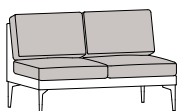

Code US28
Model COM Requirement
5102 Back & Seat Cushion = 3³/₄ yds.
Balance of Chair = 2³/₄ yds.

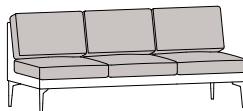

Code US29
Models COM Requirement
5103 Back & Seat Cushion = 5¹/₄ yds.
Balance of Chair = 3¹/₂ yds.

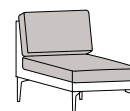

Code US30
Model COM Requirement
5105 Back & Seat Cushion = 3 yds.
Balance of Chair = 2¹/₂ yds.

UPTOWN SOCIAL LOUNGE-MODULAR

designed by chris and jon panichella

UPHOLSTERY COMBINATIONS:

For fabric, vinyl or leather upholstery combinations, refer to the pricing below:

- When combining **two** COM/COV/COL fabrics, or fabrics with the same grade, add the following (per unit):
 - › \$65 List for lounge chairs and single seat benches
 - › \$105 List for love seats, chaise lounge and 2-seat units
 - › \$130 List for sofas
- When combining **three or more** COM/COV/COL fabrics, or fabrics with the same grade, add the following (per unit):
 - › \$75 List for lounge chairs and single seat benches

- › \$115 List for love seats, chaise lounge and 2-seat units
- › \$140 List for sofas

- When combining different grades of fabric, price will be based on the highest grade specified.
- Two-tone upholstery examples and yardage requirements for the most common combinations are listed below. Additional combinations available, please contact Customer Service for yardage requirements and pricing.
- Note: Yardage amounts are based on fabric which is plain (i.e. non-directional) and a full 54" wide.
- **Appropriate upholstery code must be included on order.**

SIN #711-16

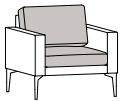

Code US31

Model COM Requirement
5101-4LR Back & Seat Cushion = 2¹/₂ yds.
Balance of Chair = 3¹/₂ yds.

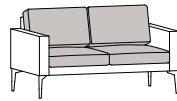

Code US32

Models COM Requirement
5102-4LR Back & Seat Cushion = 3³/₄ yds.
Balance of Chair = 4¹/₄ yds.

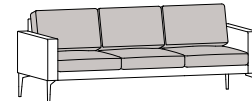

Code US33

Model COM Requirement
5103-4LR Back & Seat Cushion = 5¹/₄ yds.
Balance of Chair = 5 yds.

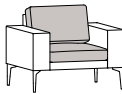

Code US34

Model COM Requirement
5101-7LR Back & Seat Cushion = 2¹/₂ yds.
Balance of Chair = 3¹/₄ yds.

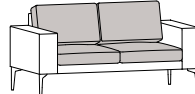

Code US35

Model COM Requirement
5102-7LR Back & Seat Cushion = 3³/₄ yds.
Balance of Chair = 4¹/₄ yds.

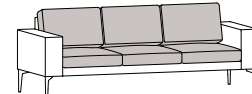

Code US36

Model COM Requirement
5103-7LR Back and Seat Cushion = 5¹/₄ yds.
Balance of Chair = 5 yds.



Code US37

Model COM Requirement
5104 Back and Seat Cushion = 3 yds.
Balance of Chair = 3¹/₄ yds.

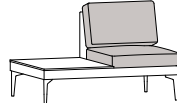

Code US38

Model COM Requirement
5111-TR Back and Seat Cushion = 2¹/₂ yds.
5111-TL Balance of Chair = 2 yds.

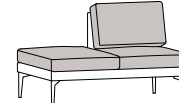

Code US39

Model COM Requirement
5111-BR Back & Seat Cushion = 3¹/₂ yds.
5111-BL Balance of Chair = 2 yds.

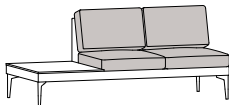

Code US40

Model COM Requirement
5112-TL Back & Seat Cushion = 4 yds.
5112-TR Balance of Chair = 3 yds.

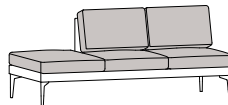

Code US41

Model COM Requirement
5112-BL Back & Seat Cushion = 5¹/₄ yds.
5112-BR Balance of Chair = 3¹/₄ yds.



Code US42

Model COM Requirement
5106 Back & Seat Cushion = 3¹/₄ yds.
Balance of Chair = 2¹/₄ yds.

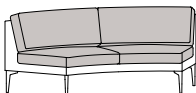

Code US43

Model COM Requirement
5107 Back & Seat Cushion = 6¹/₄ yds.
Balance of Chair = 4¹/₂ yds.

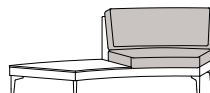

Code US44

Models COM Requirement
5113-TL Back & Seat Cushion = 3 yds.
5113-TR Balance of Chair = 2¹/₂ yds.

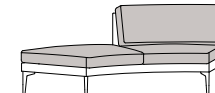

Code US45

Model COM Requirement
5113-BL Back & Seat Cushion = 5³/₄ yds.
5113-BR Balance of Chair = 2³/₄ yds.



UPTOWN SOCIAL OCCASIONAL TABLES

designed by chris and jon panichella

SIN #711-11

PRODUCT FEATURES:

- Three finish material options:
 - › Veneer top with veneer body as standard, unless otherwise specified.
 - › Laminate top with laminate body as standard, unless otherwise specified.
 - › Corian top with veneer or laminate body. **Wood species and finish selection must be specified.**
- Veneer available in Walnut and White Oak, in all standard and custom wood finishes.
- For custom wood finishes, please add \$400 List per color per order.
- When ordering in laminate, specify laminate manufacturer, color and pattern number.
- If standard laminate is specified, no upcharge.
- For custom laminates, add \$500 List per color per order. Pre-approval required, please contact Customer Service.
- Corian top is affixed to table surface increasing overall table height by $\frac{1}{2}$ ". Please note that a $\frac{1}{8}$ " reveal will be present.
- Die-cast aluminum legs feature adjustable glides and are available in standard and premium finishes, options listed below.
- For premium metal finishes, please specify "-PF04" with color selection and add \$135 List per unit.
- Optional wood trim is featured on all sides and can be specified in Walnut and White Oak, in all standard and custom finishes.
- Non-skid glides available for hard surface floors, please specify "-NS02B" after model number and add \$20 List per unit.
- All dimensions are nominal.

STANDARD METAL FINISH COLORS:

#06 Charcoal Grey
 #90 Metallic Silver
 #92 Polished Aluminum
 #95 Satin Black

PREMIUM FINISH COLORS:

#07 Gold Shimmer #83 Metallic Champagne
 #08 Penny #94 Cotton
 #09 Brown Sugar

CORIAN® COLORS:

Designer White
 Linen
 Rain Cloud
 Witch Hazel

Corian® is a registered trademark of Dupont.

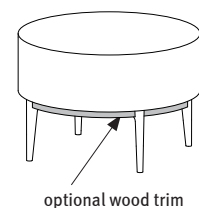

UPTOWN SOCIAL OCCASIONAL TABLES

designed by chris and jon panichella



SIN #711-11

POWER UNITS:

- Unit will be positioned in the center of tables as standard, unless otherwise specified.
- PB1 and PB2 dimensions: 5³/₄" W x 2¹/₂" D
- PB3 dimensions: 6¹/₂" W x 2¹/₂" D
- Metallic Silver or White finish with 108" electrical cord.
- UL listed.



PB1

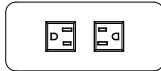

PB2



PB3

- PB1 unit features one outlet and two USB charging ports.
- PB2 unit features two outlets.
- PB3 unit features two outlets and two USB charging ports.

NOTES:

- Tables available in Walnut and White Oak veneer as well as laminate and Corian.
- Corian top is affixed to table surface increasing overall table height by 1/2" and features 1/8" reveal.
- **Table with Corian top, wood body species and finish selection must be specified.**
- Metal legs available in standard and premium finishes.

SPECIFY:

1. Model number
2. Table wood species
3. Table finish
4. Leg finish
5. Options, as applicable



ORDERING EXAMPLE:

#5135-3616-CO-WT02-PF04
 36" Round Table
 Corian Top
 Wood Trim
 Premium Leg Finish

UPTOWN SOCIAL
 OCCASIONAL TABLES

designed by chris and jon panichella

SIN #711-11

MODEL NUMBER		PRODUCT SPECIFICATIONS			
		MODEL NUMBER	VENEER OR LAMINATE	CORIAN (-CO)	WEIGHT
5130  	Square/Rectangle Table				
	18" W x 18" D x 16" H	5130-181816	1146	1450	19
	24" W x 24" D x 16" H	5130-242416	1294	1834	23
	30" W x 30" D x 16" H	5130-303016	1555	2399	30
	36" W x 36" D x 16" H	5130-363616	1778	3173	36
	42" W x 42" D x 16" H	5130-424216	1958	3857	45
	48" W x 22" D x 16" H	5130-482216	1751	2888	25
5135 	Round Table				
	18" Dia. x 16" H	5135-1816	1179	1483	19
	24" Dia. x 16" H	5135-2416	1333	1873	23
	30" Dia. x 16" H	5135-3016	1601	2445	27
	36" Dia. x 16" H	5135-3616	1832	3227	36
	42" Dia. x 16" H	5135-4216	2017	3916	45

OPTIONS (XXXX - REFERS TO TABLE MODEL NUMBER)

MODEL	DESCRIPTION	LIST
XXXX-WT01	Wood Trim - 18", 24" and 30" Square/Rounds	272
XXXX-WT02	Wood Trim - 36", 42" Square/Rounds and 48" x 22" Rectangle	380
XXXX-NS02B	Non-Skid Glides	20
XXXX-PF04	Premium Leg Finish	135
XXXX-PB1-S	Power Band 1 (one power, two USB), Silver	413
XXXX-PB1-W	Power Band 1 (one power, two USB), White	413
XXXX-PB2-S	Power Band 2 (dual power), Silver	322
XXXX-PB2-W	Power Band 2 (dual power), White	322
XXXX-PB3-S	Power Band 3 (dual power, two USB), Silver	429
XXXX-PB3-W	Power Band 3 (dual power, two USB), White	429

NOTES:

- Two back sizes.
- One-piece wood seat shell available in Beech, Walnut and White Oak in all standard and custom wood finishes.
- For custom wood finishes (including #01 Pure White), please add one-time upcharge of \$400 List per color per order.
- Available in all wood or with an upholstered seat cushion.
- Metal frame available in standard and premium finish selections.
- Footrest is positioned 10¹/₂" from the floor.
- 350 lbs. maximum weight capacity.

SPECIFY:

1. Model number
2. Wood species
3. Wood finish
4. Frame finish
5. Upholstery selection, as applicable
6. Options, as applicable

ORDERING EXAMPLE:

#3125-GD01





Low Back, Wood Seat
Upholstered Seat Cushion
Glides

UPWARD BARSTOOLS

designed by qdesign



SIN #711-16

MODEL NUMBER	PRODUCT SPECIFICATIONS	FABRIC GRADES								LEATHER GRADES					
		COM	1	2	COL			4	5	6	7	8	L1	L2	L3
3120 	Low Back, Wood Seat W 15 ¹ / ₂ D 16 ¹ / ₂ H 37 Seat Height 30 ³ / ₄ Seat Width 15 ¹ / ₂ Seat Depth 14 19 lbs.	680													
3125 	Low Back, Wood Seat with Upholstered Seat Pad W 15 ¹ / ₂ D 17 H 37 Seat Height 30 ³ / ₄ Seat Width 15 ¹ / ₂ Seat Depth 14 1/2 Yd. 20 lbs. COL 10 Sq. Ft. TB 133, add \$23 List	742	771	778	790	802	813	825	836	849	904	944	983		
3130 	Mid-Back, Wood Seat W 15 ¹ / ₂ D 16 ¹ / ₂ H 41 Seat Height 30 ¹ / ₄ Seat Width 15 ¹ / ₂ Seat Depth 14 20 lbs.	701													
3135 	Mid-Back, Wood Seat with Upholstered Seat Pad W 15 ¹ / ₂ D 17 H 41 Seat Height 30 ³ / ₄ Seat Width 15 ¹ / ₂ Seat Depth 14 1/2 Yd. 21 lbs. COL 10 Sq. Ft. TB 133, add \$23 List	760	789	796	808	820	831	843	854	867	922	962	1001		
STANDARD FRAME FINISHES: #06 Charcoal Grey #90 Metallic Silver #91 Chrome #95 Satin Black	PREMIUM FRAME FINISHES (ADD \$80 LIST) #07 Gold Shimmer #08 Penny #09 Brown Sugar #83 Metallic Champagne #94 Cotton														

OPTIONS (XXXX - REFERS TO BARSTOOL MODEL NUMBER)

MODEL	DESCRIPTION	LIST
XXXX-PF02	Premium Finish	80
XXXX-GD01	Glides (For Hard-Surface Flooring)	20



VERO MEETING TABLES

designed by ramsey madsen
and jim contoio

PRODUCT FEATURES:

- Round rectilinear arc square and arc rectangle top shapes.
- Available in three heights: 27" 29" and 42".
- Tables tops offered in Maple, Walnut and White Oak veneer as well as laminate and Corian selections (select sizes only).
- All standard wood finishes available on selected wood species (note: #26 Ebony Maple not available).
- For custom wood finishes please add one-time upcharge of \$400 List per color per order.
- Laminate tops available in all Arcadia standard laminates.
- For custom laminates, add \$500 List per color per order. Pre-approval required, please contact Customer Service.
- Unless specified wood grain direction will run lengthwise on all rectangular table sizes.
- Corian top available in four standard colors. Finish selection for wood edge detail must be specified.
- Signature metal base standard with non-skid adjustable glides and is offered in standard and premium finishes as well as Polished Aluminum.
- Base design facilitates wire management for through-the-surface power capability.
- Select technology options for top surface placement available on all sizes please refer to pages 8-9 for options.
- All dimensions are nominal.

EDGE DETAIL:

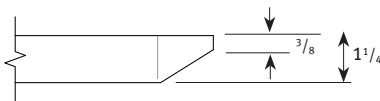

Veneer Top Wood Edge

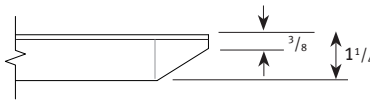

Laminate Top Exposed Wood Edge

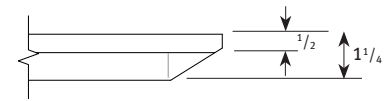

Corian Top Exposed Wood Edge

- Table with veneer or laminate top wood edge finish will match top finish color unless otherwise specified.
- For Corian top specify "-CO" next to model number. Finish selection for bottom of edge must be specified.

CORIAN® COLORS:

Designer White
Linen
Rain Cloud
Witch Hazel

Corian® is a registered trademark of Dupont.

VERO MEETING TABLES

designed by ramsey madsen
and jim contoio



BASE CONFIGURATION GUIDE:



X1 Base

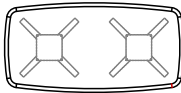

X2 Base

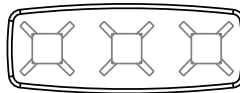

X3 Base



Y1 Base

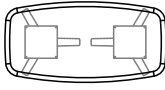

Y2 Base

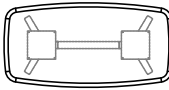

YS Base

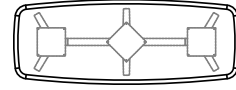

YX Base

- Base configuration varies per table with model number reflecting the corresponding style (e.g. V3-368429-YS represents a 36" W x 84" L x 29" H Arc Rectangle with YS base).
- Base available in standard and premium finish colors as well as Polished Aluminum.

STANDARD BASE FINISH COLORS:

- #06 Charcoal Grey
- #90 Metallic Silver
- #95 Satin Black

PREMIUM BASE FINISH COLORS:

- #07 Gold Shimmer
- #08 Penny
- #09 Brown Sugar
- #83 Metallic Champagne
- #94 Cotton

POWER UNITS:

- Select technology options for through-the-surface placement available on all sizes please refer to pages 8-9 for options. Note: placement exceptions may apply.

NOTES:

- Available in Maple, Walnut and White Oak veneer as well as laminate and Corian selections.
- Metal base available in standard and premium finishes as well as Polished Aluminum.
- Refer to pages 8-9 for available power units.

SPECIFY:

- Model number
- Wood species
- Wood finish
- Edge finish
- Base finish
- Options as applicable

ORDERING EXAMPLE:

#V1-3627-Y1-CO

36" Round Table 27" High
Corian Top

VERO

MEETING TABLES

designed by ramsey madsen
and jim contois



	TOP SIZES	MODEL NUMBER	STANDARD BASE FINISH	PREMIUM BASE FINISH	POLISHED ALUMINUM BASE	CORIAN TOP (-CO) Add upcharge to applicable base finish column	WEIGHT Veneer/laminate top and base
	Round Top 27" H						
	30 Dia. x 27 H	V1-3027-Y1	2736	2904	3216	971	47
	36 Dia. x 27 H	V1-3627-Y1	3048	3216	3528	1602	56
	42 Dia. x 27 H	V1-4227-Y1	3389	3557	3869	2179	69
	48 Dia. x 27 H	V1-4827-Y1	3728	3896	4209	2847	82
	Round Top 29" H						
	30 Dia. x 29 H	V1-3029-Y1	2774	2942	3254	971	47
	36 Dia. x 29 H	V1-3629-Y1	3084	3252	3565	1602	56
	42 Dia. x 29 H	V1-4229-Y1	3418	3586	3985	2179	69
	48 Dia. x 29 H	V1-4829-Y1	3758	3926	4326	2847	82
	Round Top 42" H						
	30 Dia. x 42 H	V1-3042-Y1	3415	3583	4026	971	54
	36 Dia. x 42 H	V1-3642-Y1	3726	3894	4337	1602	63
	42 Dia. x 42 H	V1-4242-Y1	4077	4245	4688	2179	76
	48 Dia. x 42 H	V1-4842-Y1	4416	4584	5028	2847	89

VERO MEETING TABLES

designed by ramsey madsen
and jim contoio

NOTES:

- Available in Maple, Walnut and White Oak veneer as well as laminate selections.
- Metal base available in standard and premium finishes as well as Polished Aluminum.
- Refer to pages 8-9 for available power units.

SPECIFY:

1. Model number
2. Wood species
3. Wood finish
4. Edge finish
5. Base finish
6. Options as applicable

ORDERING EXAMPLE:

#V2-308442-X2
30" x 84" Rectangle
42" High

TOP SIZES	MODEL NUMBER	STANDARD BASE FINISH	PREMIUM BASE FINISH	POLISHED ALUMINUM BASE	WEIGHT Top and base	
 <p>X2 Base</p>	Rectilinear Top 29" H					
	30 W x 60 L x 29 H	V2-306029-X2	5142	5426	6431	110
	30 W x 72 L x 29 H	V2-307229-X2	5460	5744	6750	120
	30 W x 84 L x 29 H	V2-308429-X2	5925	6208	7214	131
	36 W x 60 L x 29 H	V2-366029-X2	5374	5658	6664	124
	36 W x 72 L x 29 H	V2-367229-X2	5772	6056	7269	137
	36 W x 84 L x 29 H	V2-368429-X2	6061	6345	7557	150
	Rectilinear Top 42" H					
	30 W x 60 L x 42 H	V2-306042-X2	6703	6986	8341	131
	30 W x 72 L x 42 H	V2-307242-X2	7022	7305	8660	142
	30 W x 84 L x 42 H	V2-308442-X2	7486	7769	9124	152
	36 W x 60 L x 42 H	V2-366042-X2	7025	7308	8663	147
	36 W x 72 L x 42 H	V2-367242-X2	7468	7752	9096	160
	36 W x 84 L x 42 H	V2-368442-X2	7758	8041	9384	173

NOTES:

- Available in Maple, Walnut and White Oak veneer as well as laminate and Corian selections.
- Metal base available in standard and premium finishes as well as Polished Aluminum.
- Refer to pages 8-9 for available power units.

SPECIFY:

1. Model number
2. Wood species
3. Wood finish
4. Edge finish
5. Base finish
6. Options as applicable

ORDERING EXAMPLE:

#V3-3629-X1-CO



36" Rectangle Table 29" High
Corian Top

VERO

MEETING TABLES

designed by ramsey madsen
and jim contois



	TOP SIZES	MODEL NUMBER	STANDARD BASE FINISH	PREMIUM BASE FINISH	POLISHED ALUMINUM BASE	CORIAN TOP (-CO) Add upcharge to applicable base finish column	WEIGHT Veneer/laminate top and base
	Arc Square Top 27" H						
	30 W x 30 L x 27 H	V3-303027-X1	2904	3072	3537	933	56
	36 W x 36 L x 27 H	V3-363627-X1	3203	3371	3836	1540	67
	42 W x 42 L x 27 H	V3-424227-X1	3539	3707	4184	2095	82
	48 W x 48 L x 27 H	V3-484827-X1	3867	4035	4511	2737	97
	Arc Square Top 29" H						
	30 W x 30 L x 29 H	V3-303029-X1	2943	3111	3587	933	56
	36 W x 36 L x 29 H	V3-363629-X1	3243	3411	3888	1540	67
	42 W x 42 L x 29 H	V3-424229-X1	3569	3737	4323	2095	82
	48 W x 48 L x 29 H	V3-484829-X1	3897	4065	4651	2737	97
	Arc Square Top 42" H						
	30 W x 30 L x 42 H	V3-303042-X1	3731	3899	4550	933	67
	36 W x 36 L x 42 H	V3-363642-X1	4030	4198	4849	1540	78
	42 W x 42 L x 42 H	V3-424242-X1	4380	4548	5199	2095	91
	48 W x 48 L x 42 H	V3-484842-X1	4708	4876	5527	2737	106

VERO MEETING TABLES

designed by ramsey madsen
and jim contoio



NOTES:

- Available in Maple, Walnut and White Oak veneer as well as laminate selections.
- Metal base available in standard and premium finishes as well as Polished Aluminum.
- Refer to pages 8-9 for available power units.

SPECIFY:

1. Model number
2. Wood species
3. Wood finish
4. Edge finish
5. Base finish
6. Options as applicable

ORDERING EXAMPLE:

#V3-308427-X2
30" x 84" Arc Rectangle
42" High

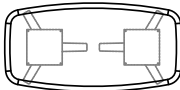
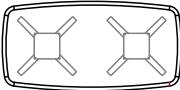
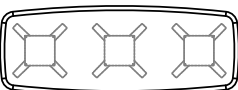
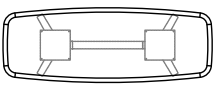
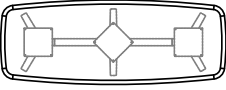

	TOP SIZES	MODEL NUMBER	STANDARD BASE FINISH	PREMIUM BASE FINISH	POLISHED ALUMINUM BASE	WEIGHT Top and base	
<p>Base Configuration Reference Guide</p>  <p>Y2 Base</p>  <p>X2 Base</p>  <p>X3 Base</p>  <p>YS Base</p>  <p>YX Base</p>	<p>Arc Rectangle Top 27" H</p> <p>30 W x 60 L x 27 H 30 W x 72 L x 27 H 30 W x 84 L x 27 H 30 W x 96 L x 27 H 36 W x 60 L x 27 H 36 W x 72 L x 27 H 36 W x 84 L x 27 H 36 W x 96 L x 27 H 42 W x 84 L x 27 H 42 W x 96 L x 27 H 42 W x 120 L x 27 H 48 W x 96 L x 27 H 48 W x 120 L x 27 H</p>	<p>V3-306027-Y2 V3-307227-Y2 V3-308427-X2 V3-309627-X3 V3-366027-Y2 V3-367227-Y2 V3-368427-X2 V3-369627-X3 V3-428427-X2 V3-429627-X3 V3-4212027-X3 V3-489627-X3 V3-4812027-X3</p>	<p>4676 5005 5827 7305 4908 5266 6059 7392 6216 7584 8511 7683 8602</p>	<p>4960 5288 6110 7641 5192 5550 6342 7728 6500 7920 8847 8019 8938</p>	<p>5626 5955 7093 9206 5858 6216 7326 9293 7505 9506 10433 9605 10524</p>	<p>100 110 131 160 110 123 146 188 168 210 239 225 261</p>	
		<p>Arc Rectangle Top 29" H</p> <p>30 W x 60 L x 29 H 30 W x 72 L x 29 H 30 W x 84 L x 29 H 30 W x 96 L x 29 H 36 W x 60 L x 29 H 36 W x 72 L x 29 H 36 W x 84 L x 29 H 36 W x 96 L x 29 H 42 W x 84 L x 29 H 42 W x 96 L x 29 H 42 W x 120 L x 29 H 48 W x 96 L x 29 H 48 W x 120 L x 29 H</p>	<p>V3-306029-Y2 V3-307229-YS V3-308429-YS V3-309629-YX V3-366029-YS V3-367229-YS V3-368429-YS V3-369629-YX V3-428429-YS V3-429629-YX V3-4212029-X3 V3-489629-YX V3-4812029-X3</p>	<p>4706 5115 5444 6983 5019 5376 5676 7070 5782 7164 8481 7279 8573</p>	<p>4989 5399 5727 7319 5303 5660 5959 7406 6065 7500 8817 7645 8909</p>	<p>5666 6130 6459 8676 6036 6393 6692 8763 6896 9020 10731 9135 10823</p>	<p>102 112 123 145 111 124 138 181 160 203 240 217 262</p>
		<p>Arc Rectangle Top 42" H</p> <p>30 W x 60 L x 42 H 30 W x 72 L x 42 H 30 W x 84 L x 42 H 36 W x 60 L x 42 H 36 W x 72 L x 42 H 36 W x 84 L x 42 H</p>	<p>V3-306042-Y2 V3-307242-Y2 V3-308442-X2 V3-366042-Y2 V3-367242-Y2 V3-368442-X2</p>	<p>5998 7133 7447 6321 7485 7769</p>	<p>6282 7417 7731 6605 7768 8053</p>	<p>7221 8356 9085 7545 8707 9407</p>	<p>112 135 146 122 148 161</p>

NOTES:

- For placement directly over bases PB1 and PB2 are the only options available due to the limited opening size.
- For tables with X2 X3 Y2 and YS base configurations all power units can be positioned between bases with center placement as standard unless otherwise specified.
- Tables with YX base configuration power unit cannot be placed directly in the center due to the limited opening size.

VERO MEETING TABLES

designed by ramsey madsen
and jim contoio

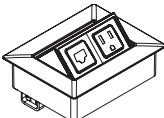
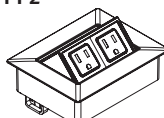
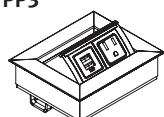
MODEL #	PRODUCT SPECIFICATIONS	LIST
PB1 	Power Band 1 <ul style="list-style-type: none"> ▪ Dimensions: 5³/₄" W x 2¹/₂" D ▪ Metallic Silver or White finish ▪ One (1) outlet and two (2) USB charging ports ▪ 108" electrical cord (only length available) ▪ UL Listed 	413
PB2 	Power Band 2 <ul style="list-style-type: none"> ▪ Dimensions: 5³/₄" W x 2¹/₂" D ▪ Metallic Silver or White finish ▪ Two (2) outlets ▪ 108" electrical cord (only length available) ▪ UL Listed 	322
PB3 	Power Band 3 <ul style="list-style-type: none"> ▪ Dimensions: 6¹/₂" W x 2¹/₂" D ▪ Metallic Silver or White finish ▪ Two (2) outlets and two (2) USB charging ports ▪ 108" electrical cord (only length available) ▪ UL Listed 	429
PP1 	Portal Power 1 <ul style="list-style-type: none"> ▪ Dimensions: 5¹/₄" W x 4¹/₄" D ▪ Touch latch lid with Satin Nickel finish ▪ Unit features one simplex outlet with 72" electrical cord and one RJ-45 jack (Cat 6) with 72" patch cable ▪ 120" length cord available please specify and add \$30 List ▪ UL listed 	612
PP2 	Portal Power 2 <ul style="list-style-type: none"> ▪ Dimensions: 5¹/₄" W x 4¹/₄" D ▪ Touch latch lid with Satin Nickel finish ▪ Unit features two simplex outlets with 72" electrical cord ▪ 120" length cord available please specify and add \$30 List ▪ UL listed 	542
PP3 	Portal Power 3 <ul style="list-style-type: none"> ▪ Dimensions: 5¹/₄" W x 4¹/₄" D ▪ Touch latch lid with Satin Nickel finish ▪ Unit features one simplex outlet with 72" electrical cord and dual USB charging ports ▪ 120" length cord available please specify and add \$30 List ▪ UL listed 	643

VERO MEETING TABLES

designed by ramsey madsen
and jim contoio

NOTES:

- For placement directly over bases PB1 and PB2 are the only options available due to the limited opening size.
- For tables with X2 X3 Y2 and YS base configurations all power units can be positioned between bases with center placement as standard unless otherwise specified.
- Tables with YX base configuration power unit cannot be placed directly in the center due to the limited opening size.
- For the following technology units please reference A/V jack combination options below. The price of individual A/V jacks must be added to the Base Model unit price listed below.
- Please contact Customer Service for faceplate/jack combinations that may not be referenced herein.
- Select units show open port positions which once A/V jacks are purchased can be reconfigured with different A/V jacks as needed.
- A/V jacks and faceplates snap into opening(s) in metal housing of Base Model units.

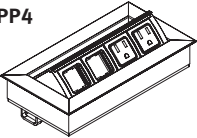
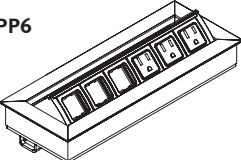
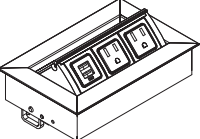
MODEL #	PRODUCT SPECIFICATIONS	LIST
<p>PP4</p> 	<p>Portal Power 4</p> <ul style="list-style-type: none"> ▪ Dimensions: 8⁵/₁₆" W x 4¹/₄" D ▪ Touch latch lid with clear anodized aluminum finish ▪ Two (2) 15 amp simplex outlets and two (2) open ports ▪ 72" electrical cord no A/V jacks included ▪ 120" length cord available please specify and add \$30 List ▪ UL Listed 	575
<p>PP6</p> 	<p>Portal Power 6</p> <ul style="list-style-type: none"> ▪ Dimensions: 9¹³/₁₆" W x 4¹/₄" D ▪ Touch latch lid with clear anodized aluminum finish ▪ Three (3) 15 amp simplex outlets and three (3) open ports ▪ 72" electrical cord no A/V jacks included ▪ 120" length cord available please specify and add \$30 List ▪ UL Listed 	612
<p>PP7</p> 	<p>Portal Power 7</p> <ul style="list-style-type: none"> ▪ Dimensions: 6³/₄" W x 4³/₈" D ▪ Touch latch lid with clear anodized aluminum finish ▪ Two (2) 15 amp simplex outlets and two (2) USB charging ports ▪ 72" electrical cord ▪ 120" length cord available please specify and add \$30 List ▪ UL Listed 	665

FACEPLATE CONFIGURATION OPTIONS

ID#	PART #	A/V JACK DESCRIPTION(S)	LIST
1)	Q1	(1) RJ-45 (Cat 5e) punchdown	\$33
2)	Q2	(1) RJ-45 (Cat 6) male/female pre-terminated 72" long	\$87
3)	Q3	(1) RJ-45 (Cat 6) male/female pre-terminated 120" long	\$87
4)	Q4	15 pin HD VGA with male/female cable 72" long	\$87
5)	Q5	15 pin HD VGA with male/female cable 120" long	\$102
6)	Q6	3.5mm Mini-Stereo jack with male/female cable 120" long	\$33
7)	Q9	HDMI Corded Coupler 18" long	\$82

NOTES:

- For placement directly over bases PB1 and PB2 are the only options available due to the limited opening size.
- For tables with X2 X3 Y2 and YS base configurations all power units can be positioned between bases with center placement as standard unless otherwise specified.
- Tables with YX base configuration power unit cannot be placed directly in the center due to the limited opening size.
- For the following technology units please reference A/V jack combination options below. The price of individual A/V jacks must be added to the Base Model unit price listed below.
- Please contact Customer Service for faceplate/jack combinations that may not be referenced herein.
- Select units show open port positions which once A/V jacks are purchased can be reconfigured with different A/V jacks as needed.
- A/V jacks and faceplates snap into opening(s) in metal housing of Base Model units.

VERO MEETING TABLES

designed by ramsey madsen
and jim contoio

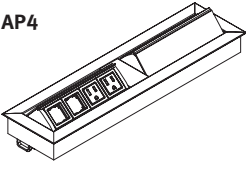
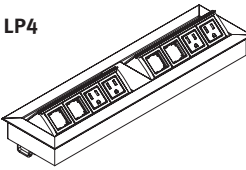
MODEL #	PRODUCT SPECIFICATIONS	LIST
<p>AP4</p> 	<p>Alternate Portal 4</p> <ul style="list-style-type: none"> ▪ Dimensions: 16¹/₂" W x 4¹/₂" D ▪ Touch latch lid with clear anodized aluminum finish ▪ Four (4) 15 amp simplex outlets and four (4) open ports ▪ 72" electrical cord no A/V jacks included ▪ 120" length cord available please specify and add \$30 List ▪ UL Listed 	1136
<p>LP4</p> 	<p>Linear Portal</p> <ul style="list-style-type: none"> ▪ Dimensions: 16¹/₂" W x 4¹/₂" D ▪ Touch latch lid with clear anodized aluminum finish ▪ Four (4) 15 amp simplex outlets and four (4) open ports ▪ 72" electrical cord no A/V jacks included ▪ 120" length cord available please specify and add \$30 List ▪ UL Listed 	1136

FACEPLATE CONFIGURATION OPTIONS

ID#	PART #	A/V JACK DESCRIPTION(S)	LIST
1)	Q1	(1) RJ-45 (Cat 5e) punchdown	\$33
2)	Q2	(1) RJ-45 (Cat 6) male/female pre-terminated 72" long	\$87
3)	Q3	(1) RJ-45 (Cat 6) male/female pre-terminated 120" long	\$87
4)	Q4	15 pin HD VGA with male/female cable 72" long	\$87
5)	Q5	15 pin HD VGA with male/female cable 120" long	\$102
6)	Q6	3.5mm Mini-Stereo jack with male/female cable 120" long	\$33
7)	Q9	HDMI Corded Coupler 18" long	\$82



WORKSMITH MEETING TABLES

designed by rainlight

TABLE TOP FEATURES:

- Tables manufactured in Ash wood species.
- 1¹/₄" top thickness.
- Solid wood, veneer, laminate and clear glass options.
- Veneer direction will run lengthwise on all tables.
- For custom wood finishes, please add one-time upcharge of \$400 List per color per order.
- Laminate tops available in all Arcadia standard laminates.
- For custom laminates, add \$500 List per color per order. Pre-approval required, please contact Customer Service.
- Unless specified, laminate wood grain direction will run lengthwise on all rectangle table sizes.
- Solid wood top standard with matching edge.
- Table with veneer or laminate top, two edge finish options:
 - › Self-edge matched to veneer or laminate top selection.
 - › Exposed plywood edge matched to veneer or wood grain laminate top selection only. For solid color laminates, plywood edge is finished in clear coat only.
- When ordering in laminate, specify laminate manufacturer, color and pattern number.
- Clear glass top is 1/2" thick and available on select sizes.
- Custom table top sizes available, contact Customer Service for pricing.
- Select technology options available for solid wood, veneer or laminate top surface placement, refer to pages 10-13 for details.
- Ordered separately, ganging mechanism comes three per set to connect two tables together (end-to-end only). For solid wood planked table tops, alignment of planks may vary slightly when connected end-to-end due to the natural properties of the material.
- All dimensions are nominal.

ASH WOOD FINISHES*:

#162 White Oak on Ash	#165 Kona Ash
#163 Walnut on Ash	#166 Smoky Umber Ash
#164 Cocoa Ash	#167 Slate Grey Ash

*Please note that finishes will appear slightly darker on tables specified in solid wood.

WORKSMITH MEETING TABLES

designed by rainlight



BASE FEATURES:

- 29", 36" and 42" table heights (varies with top size). Planked top tables 48" and 54" wide will be $\frac{3}{4}$ " taller due to sub-top requirement.
- Solid Ash wood or cast metal leg options.
- Solid Ash legs offered on all table heights.
- Wood legs will match solid wood, veneer or wood grain laminate tops as standard, unless otherwise specified. For solid color laminates and glass tops, please specify leg finish on Ash.
- For custom wood finishes, please add one-time upcharge of \$400 List per color per order.
- Cast metal legs offered on 29" and 42" table heights only and feature textured matte black finish.
- All legs are assembled with cast metal shoulders in textured matte black finish and feature wood support beam attachments.
- Wood support beams will match wood leg finish as standard. For metal legs, please specify finish on Ash.
- 36" and 42" high tables also feature wood stretchers for added durability.
- Bases standard with non-skid adjustable glides.
- Field-assembly required.

NOTES:

- Planked top tables manufactured in Ash, with solid Ash wood legs.
- Solid wood, veneer and laminate options.
- Veneer and laminate tables offered with self-edge or exposed edge.
- Refer to pages 10-13 for electrical unit options.

SPECIFY:

1. Model number
2. Top finish
3. Wood finish
4. Options, as applicable

ORDERING EXAMPLE:

#9110-427229-SE
 42 x 72 x 29 Planked Top Table
 Self-Edge
 Wood Legs

WORKSMITH
MEETING TABLES

designed by rainlight



TABLE TOP FINISH					
PLANK TOP - WOOD LEGS	MODEL NUMBER	SOLID WOOD (-SW)	VENEER OR LAMINATE SELF-EDGE (-SE)	VENEER OR LAMINATE EXPOSED EDGE (-EP)	WEIGHT SOLID WOOD/ VENEER OR LAM
	29" Height				
	32 W x 60 L x 29 H	9110-326029-()	4534	4038	81/66
	32 W x 72 L x 29 H	9110-327229-()	4861	4266	95/77
	32 W x 84 L x 29 H	9110-328429-()	5193	4498	109/88
	32 W x 96 L x 29 H	9110-329629-()	5524	4731	123/100
	32 W x 120 L x 29 H	9110-3212029-()	6091	4941	149/121
	36 W x 72 L x 29 H	9110-367229-()	5092	4417	110/89
	36 W x 84 L x 29 H	9110-368429-()	5447	4658	125/101
	36 W x 96 L x 29 H	9110-369629-()	5802	4900	140/113
	36 W x 120 L x 29 H	9110-3612029-()	6415	5115	164/133
	42 W x 72 L x 29 H	9110-427229-()	5503	4548	130/105
	42 W x 84 L x 29 H	9110-428429-()	5910	4795	145/117
	42 W x 96 L x 29 H	9110-429629-()	6316	5041	160/130
	42 W x 120 L x 29 H	9110-4212029-()	7032	5258	188/152
	48 W x 84 L x 29 H	9110-488429-()	6374	5271	165/134
	48 W x 96 L x 29 H	9110-489629-()	6799	5455	180/146
	48 W x 120 L x 29 H	9110-4812029-()	7553	5677	208/168
	54 W x 96 L x 29 H	9110-549629-()	7190	5460	200/162
	54 W x 120 L x 29 H	9110-5412029-()	8019	5672	228/185
		36" Height			
32 W x 60 L x 36 H		9110-326036-()	5149	4653	118/96
32 W x 72 L x 36 H		9110-327236-()	5476	4881	132/107
32 W x 84 L x 36 H		9110-328436-()	5808	5113	146/118
32 W x 96 L x 36 H		9110-329636-()	6139	5346	160/130
32 W x 120 L x 36 H		9110-3212036-()	6706	5556	186/151
36 W x 72 L x 36 H		9110-367236-()	5707	5032	147/119
36 W x 84 L x 36 H		9110-368436-()	6062	5273	162/131
36 W x 96 L x 36 H		9110-369636-()	6417	5515	177/143
36 W x 120 L x 36 H		9110-3612036-()	7030	5730	201/163
42 W x 72 L x 36 H		9110-427236-()	6118	5163	167/135
42 W x 84 L x 36 H		9110-428436-()	6525	5410	183/148
42 W x 96 L x 36 H		9110-429636-()	6931	5656	206/167
42 W x 120 L x 36 H		9110-4212036-()	7647	5873	234/190
48 W x 84 L x 36 H		9110-488436-()	6989	5886	187/151
48 W x 96 L x 36 H		9110-489636-()	7414	6070	203/164
48 W x 120 L x 36 H		9110-4812036-()	8168	6292	254/206
54 W x 96 L x 36 H		9110-549636-()	7805	6075	223/181
54 W x 120 L x 36 H		9110-5412036-()	8634	6287	274/222

WORKSMITH MEETING TABLES

designed by rainlight



NOTES:

- Planked top tables manufactured in Ash, with solid Ash wood legs.
- Solid wood, veneer and laminate options.
- Veneer and laminate tables offered with self-edge or exposed edge.
- Refer to pages 10-13 for electrical unit options.

SPECIFY:

1. Model number
2. Top finish
3. Wood finish
4. Options, as applicable

ORDERING EXAMPLE:

#9110-367242-SW

36 x 72 x 42 Planked Top Table
Solid Wood
Wood Legs

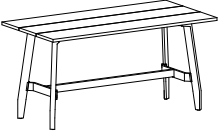
PLANK TOP - WOOD LEGS	MODEL NUMBER	TABLE TOP FINISH			WEIGHT SOLID WOOD/ VENEER OR LAM
		SOLID WOOD (-SW)	VENEER OR LAMINATE SELF-EDGE (-SE)	VENEER OR LAMINATE EXPOSED EDGE (-EP)	
 <p>42" Height</p> <p>32 W x 60 L x 42 H 32 W x 72 L x 42 H 32 W x 84 L x 42 H 32 W x 96 L x 42 H 32 W x 120 L x 42 H</p> <p>36 W x 72 L x 42 H 36 W x 84 L x 42 H 36 W x 96 L x 42 H 36 W x 120 L x 42 H</p> <p>42 W x 72 L x 42 H 42 W x 84 L x 42 H 42 W x 96 L x 42 H 42 W x 120 L x 42 H</p> <p>48 W x 84 L x 42 H 48 W x 96 L x 42 H 48 W x 120 L x 42 H</p> <p>54 W x 96 L x 42 H 54 W x 120 L x 42 H</p>	9110-326042(-)	5261	4761	4761	123/100
	9110-327242(-)	5608	5009	5009	137/111
	9110-328442(-)	5960	5261	5261	151/122
	9110-329642(-)	6311	5513	5513	165/134
	9110-3212042(-)	6906	5753	5753	191/155
	9110-367242(-)	5839	5159	5159	152/123
	9110-368442(-)	6213	5421	5421	167/135
	9110-369642(-)	6588	5682	5682	182/147
	9110-3612042(-)	7230	5926	5926	206/167
	9110-427242(-)	6250	5291	5291	172/139
	9110-428442(-)	6676	5557	5557	188/152
	9110-429642(-)	7102	5824	5824	211/171
9110-4212042(-)	7848	6070	6070	239/194	
9110-488442(-)	7141	6033	6033	192/156	
9110-489642(-)	7586	6237	6237	208/168	
9110-4812042(-)	8369	6488	6488	259/210	
9110-549642(-)	7976	6242	6242	228/185	
9110-5412042(-)	8834	6331	6331	279/226	

NOTES:

- Planked top tables manufactured in Ash, with cast metal legs.
- Solid wood, veneer and laminate options.
- Veneer and laminate tables offered with self-edge or exposed edge.
- Refer to pages 10-13 for electrical unit options.

SPECIFY:

1. Model number
2. Top finish
3. Wood finish
4. Options, as applicable

ORDERING EXAMPLE:

#9110-M-428429-SW
 42 x 84 x 29 Planked Top Table
 Solid Wood
 Metal Legs

WORKSMITH MEETING TABLES

designed by rainlight



		TABLE TOP FINISH				
PLANK TOP - METAL LEG	MODEL NUMBER	SOLID WOOD (-SW)	VENEER OR LAMINATE SELF-EDGE (-SE)	VENEER OR LAMINATE EXPOSED EDGE (-EP)	WEIGHT SOLID WOOD/ VENEER OR LAM	
<p>29" Height</p> <p>32 W x 60 L x 29 H 32 W x 72 L x 29 H 32 W x 84 L x 29 H 32 W x 96 L x 29 H 32 W x 120 L x 29 H</p> <p>36 W x 72 L x 29 H 36 W x 84 L x 29 H 36 W x 96 L x 29 H 36 W x 120 L x 29 H</p> <p>42 W x 72 L x 29 H 42 W x 84 L x 29 H 42 W x 96 L x 29 H 42 W x 120 L x 29 H</p> <p>48 W x 84 L x 29 H 48 W x 96 L x 29 H 48 W x 120 L x 29 H</p> <p>54 W x 96 L x 29 H 54 W x 120 L x 29 H</p>	9110-M-326029-(-)	4534	4038	4038	91/74	
	9110-M-327229-(-)	4861	4266	4266	105/85	
	9110-M-328429-(-)	5193	4498	4498	119/96	
	9110-M-329629-(-)	5524	4731	4731	133/108	
	9110-M-3212029-(-)	6091	4941	4941	159/129	
	9110-M-367229-(-)	5092	4417	4417	120/97	
	9110-M-368429-(-)	5447	4658	4658	135/109	
	9110-M-369629-(-)	5802	4900	4900	150/122	
	9110-M-3612029-(-)	6415	5115	5115	174/141	
	9110-M-427229-(-)	5503	4548	4548	140/113	
	9110-M-428429-(-)	5910	4795	4795	155/126	
	9110-M-429629-(-)	6316	5041	5041	170/138	
	9110-M-4212029-(-)	7032	5258	5258	198/160	
	9110-M-488429-(-)	6374	5271	5271	175/142	
	9110-M-489629-(-)	6799	5455	5455	190/154	
9110-M-4812029-(-)	7553	5677	5677	218/177		
9110-M-549629-(-)	7190	5460	5460	210/170		
9110-M-5412029-(-)	8019	5672	5672	238/193		
<p>42" Height</p> <p>32 W x 60 L x 42 H 32 W x 72 L x 42 H 32 W x 84 L x 42 H 32 W x 96 L x 42 H 32 W x 120 L x 42 H</p> <p>36 W x 72 L x 42 H 36 W x 84 L x 42 H 36 W x 96 L x 42 H 36 W x 120 L x 42 H</p> <p>42 W x 72 L x 42 H 42 W x 84 L x 42 H 42 W x 96 L x 42 H 42 W x 120 L x 42 H</p> <p>48 W x 84 L x 42 H 48 W x 96 L x 42 H 48 W x 120 L x 42 H</p> <p>54 W x 96 L x 42 H 54 W x 120 L x 42 H</p>	9110-M-326042-(-)	5261	4761	4761	133/108	
	9110-M-327242-(-)	5608	5009	5009	147/119	
	9110-M-328442-(-)	5960	5261	5261	161/130	
	9110-M-329642-(-)	6311	5513	5513	175/142	
	9110-M-3212042-(-)	6906	5753	5753	201/163	
	9110-M-367242-(-)	5839	5159	5159	162/131	
	9110-M-368442-(-)	6213	5421	5421	177/143	
	9110-M-369642-(-)	6588	5682	5682	192/156	
	9110-M-3612042-(-)	7230	5926	5926	216/175	
	9110-M-427242-(-)	6250	5291	5291	182/147	
	9110-M-428442-(-)	6676	5557	5557	198/160	
	9110-M-429642-(-)	7102	5824	5824	221/179	
	9110-M-4212042-(-)	7848	6070	6070	249/202	
	9110-M-488442-(-)	7141	6033	6033	202/164	
	9110-M-489642-(-)	7586	6237	6237	218/177	
	9110-M-4812042-(-)	8369	6488	6488	269/218	
	9110-M-549642-(-)	7976	6242	6242	238/193	
	9110-M-5412042-(-)	8834	6331	6331	289/234	

WORKSMITH MEETING TABLES

designed by rainlight

NOTES:

- Non-planked tables manufactured in Ash, with solid Ash wood legs.
- Solid wood, veneer and laminate options.
- Veneer and laminate tables offered with self-edge or exposed edge.
- Refer to pages 10-13 for electrical unit options.



SPECIFY:

1. Model number
2. Wood finish
3. Options, as applicable

ORDERING EXAMPLE:

#9111-429629-EP
42 x 96 x 29 Non-Planked Table
Exposed Edge
Wood Legs

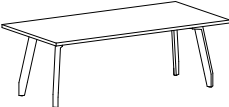
TABLE TOP FINISH

VENEER/LAMINATE NON-PLANKED TOP - WOOD LEGS	MODEL NUMBER	VENEER OR LAMINATE SELF EDGE (-SE)	VENEER OR LAMINATE EXPOSED EDGE (-EP)	WEIGHT
29" Height				
	32 W x 60 L x 29 H	9111-326029-()	4001	66
	32 W x 72 L x 29 H	9111-327229-()	4222	77
	32 W x 84 L x 29 H	9111-328429-()	4446	88
	32 W x 96 L x 29 H	9111-329629-()	4671	100
	32 W x 120 L x 29 H	9111-3212029-()	4867	121
	36 W x 72 L x 29 H	9111-367229-()	4372	89
	36 W x 84 L x 29 H	9111-368429-()	4606	101
	36 W x 96 L x 29 H	9111-369629-()	4840	113
	36 W x 120 L x 29 H	9111-3612029-()	5040	133
	42 W x 72 L x 29 H	9111-427229-()	4504	105
42 W x 84 L x 29 H	9111-428429-()	4743	117	
42 W x 96 L x 29 H	9111-429629-()	4982	130	
42 W x 120 L x 29 H	9111-4212029-()	5184	152	
48 W x 84 L x 29 H	9111-488429-()	5218	134	
48 W x 96 L x 29 H	9111-489629-()	5396	146	
48 W x 120 L x 29 H	9111-4812029-()	5602	168	
54 W x 96 L x 29 H	9111-549629-()	5400	162	
54 W x 120 L x 29 H	9111-5412029-()	5598	185	
36" Height				
	32 W x 60 L x 36 H	9111-326036-()	4616	96
	32 W x 72 L x 36 H	9111-327236-()	4837	107
	32 W x 84 L x 36 H	9111-328436-()	5061	118
	32 W x 96 L x 36 H	9111-329636-()	5286	130
	32 W x 120 L x 36 H	9111-3212036-()	5482	151
	36 W x 72 L x 36 H	9111-367236-()	4987	119
	36 W x 84 L x 36 H	9111-368436-()	5221	131
	36 W x 96 L x 36 H	9111-369636-()	5455	143
	36 W x 120 L x 36 H	9111-3612036-()	5655	163
	42 W x 72 L x 36 H	9111-427236-()	5119	135
42 W x 84 L x 36 H	9111-428436-()	5358	148	
42 W x 96 L x 36 H	9111-429636-()	5597	167	
42 W x 120 L x 36 H	9111-4212036-()	5799	190	
48 W x 84 L x 36 H	9111-488436-()	5833	151	
48 W x 96 L x 36 H	9111-489636-()	6011	164	
48 W x 120 L x 36 H	9111-4812036-()	6217	206	
54 W x 96 L x 36 H	9111-549636-()	6015	181	
54 W x 120 L x 36 H	9111-5412036-()	6213	222	

NOTES:

- Non-planked tables manufactured in Ash, with solid Ash wood legs.
- Solid wood, veneer and laminate options.
- Veneer and laminate tables offered with self-edge or exposed edge.
- Refer to pages 10-13 for electrical unit options.

SPECIFY:

1. Model number
2. Wood finish
3. Options, as applicable

ORDERING EXAMPLE:

#9111-428442-SE
 42 x 84 x 42 Non-Planked Table
 Self Edge
 Wood Legs

WORKSMITH MEETING TABLES

designed by rainlight

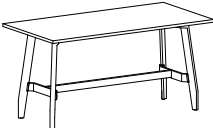
TABLE TOP FINISH					
VENEER/LAMINATE NON-PLANKED TOP - WOOD LEGS	MODEL NUMBER	VENEER OR LAMINATE SELF EDGE (-SE)	VENEER OR LAMINATE EXPOSED EDGE (-EP)	WEIGHT	
	42" Height				
	32 W x 60 L x 42 H	9111-326042-()	4724	4724	100
	32 W x 72 L x 42 H	9111-327242-()	4964	4964	111
	32 W x 84 L x 42 H	9111-328442-()	5209	5209	122
	32 W x 96 L x 42 H	9111-329642-()	5453	5453	134
	32 W x 120 L x 42 H	9111-3212042-()	5678	5678	155
	36 W x 72 L x 42 H	9111-367242-()	5115	5115	123
	36 W x 84 L x 42 H	9111-368442-()	5369	5369	135
	36 W x 96 L x 42 H	9111-369642-()	5623	5623	147
	36 W x 120 L x 42 H	9111-3612042-()	5852	5852	167
	42 W x 72 L x 42 H	9111-427242-()	5246	5246	139
	42 W x 84 L x 42 H	9111-428442-()	5505	5505	152
	42 W x 96 L x 42 H	9111-429642-()	5764	5764	171
	42 W x 120 L x 42 H	9111-4212042-()	5995	5995	194
	48 W x 84 L x 42 H	9111-488442-()	5981	5981	156
	48 W x 96 L x 42 H	9111-489642-()	6178	6178	168
	48 W x 120 L x 42 H	9111-4812042-()	6414	6414	210
	54 W x 96 L x 42 H	9111-549642-()	6182	6182	185
	54 W x 120 L x 42 H	9111-5412042-()	6409	6409	226

WORKSMITH MEETING TABLES

designed by rainlight

NOTES:

- Non-planked tables manufactured in Ash, with cast metal legs.
- Solid wood, veneer and laminate options.
- Veneer and laminate tables offered with self-edge or exposed edge.
- Refer to pages 10-13 for electrical unit options.



SPECIFY:

1. Model number
2. Wood finish
3. Options, as applicable

ORDERING EXAMPLE:

#9111-M-4212029-SE
42 x 120 x 29 Non-Planked Table
Self Edge
Metal Legs

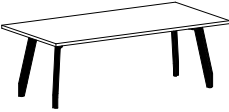
TABLE TOP FINISH

veneER/LAMINATE NON-PLANKED TOP - METAL LEGS	MODEL NUMBER	veneER OR LAMINATE SELF EDGE (-SE)	veneER OR LAMINATE EXPOSED EDGE (-EP)	WEIGHT	
 <p>29" Height</p> <p>32 W x 60 L x 29 H 32 W x 72 L x 29 H 32 W x 84 L x 29 H 32 W x 96 L x 29 H 32 W x 120 L x 29 H</p> <p>36 W x 72 L x 29 H 36 W x 84 L x 29 H 36 W x 96 L x 29 H 36 W x 120 L x 29 H</p> <p>42 W x 72 L x 29 H 42 W x 84 L x 29 H 42 W x 96 L x 29 H 42 W x 120 L x 29 H</p> <p>48 W x 84 L x 29 H 48 W x 96 L x 29 H 48 W x 120 L x 29 H</p> <p>54 W x 96 L x 29 H 54 W x 120 L x 29 H</p>					
	 <p>42" Height</p> <p>32 W x 60 L x 42 H 32 W x 72 L x 42 H 32 W x 84 L x 42 H 32 W x 96 L x 42 H 32 W x 120 L x 42 H</p> <p>36 W x 72 L x 42 H 36 W x 84 L x 42 H 36 W x 96 L x 42 H 36 W x 120 L x 42 H</p> <p>42 W x 72 L x 42 H 42 W x 84 L x 42 H 42 W x 96 L x 42 H 42 W x 120 L x 42 H</p> <p>48 W x 84 L x 42 H 48 W x 96 L x 42 H 48 W x 120 L x 42 H</p> <p>54 W x 96 L x 42 H 54 W x 120 L x 42 H</p>				

NOTES:

- Clear glass top available with solid Ash wood or cast metal legs.
- 36" and 42" high tables feature wood stretcher bar for added durability. For tables with wood legs, stretcher bar finish will match. For tables with metal legs, please specify wood finish on Ash.
- Veneer and laminate tables offered with self-edge or exposed edge.
- Electrical units not available on glass tables.

SPECIFY:

1. Model number
2. Leg finish, as applicable
3. Wood stretcher finish, as applicable
4. Options, as applicable



ORDERING EXAMPLE:

#9112-367236
36 x 72 x 36 Glass Table
Wood Legs

WORKSMITH MEETING TABLES

designed by rainlight





		MODEL NUMBER	LIST	WEIGHT
CLEAR GLASS TOP - WOOD LEGS 	29" Height 32 W x 60 L x 29 H 36 W x 72 L x 29 H	9112-326029 9112-367229	3866 4159	106 120
	36" Height 32 W x 60 L x 36 H 36 W x 72 L x 36 H	9112-326036 9112-367236	4481 4774	143 172
	42" Height 32 W x 60 L x 42 H 36 W x 72 L x 42 H	9112-326036 9112-367236	4651 4874	148 177
CLEAR GLASS TOP - METAL LEGS 	29" Height 32 W x 60 L x 29 H 36 W x 72 L x 29 H	9112-M-326029 9112-M-367229	3866 4159	116 130
	42" Height 32 W x 60 L x 42 H 36 W x 72 L x 42 H	9112-M-326036 9112-M-367236	4651 4874	158 187

WORKSMITH MEETING TABLES

designed by rainlight

NOTES:

- Electrical units not available on glass top tables.
- All units below are corded.
- Cord length should be taken into account when specifying electrical placement.
- Refer to page 13 for power unit standard locations. Please note that placement directly over bases is not available due to the limited opening size.

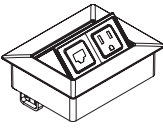
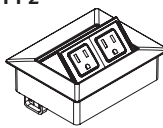
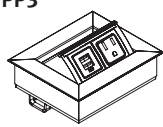
MODEL #	PRODUCT SPECIFICATIONS	LIST
<p>PB1-S (SILVER FINISH) PB1-W (WHITE FINISH)</p> 	<p>Power Band 1</p> <ul style="list-style-type: none"> ▪ Dimensions: 5³/₄" W x 2¹/₂" D ▪ Metallic Silver or White finish ▪ One (1) outlet and two (2) USB charging ports ▪ 108" electrical cord (only length available) ▪ UL Listed 	413
<p>PB2-S (SILVER FINISH) PB2-W (WHITE FINISH)</p> 	<p>Power Band 2</p> <ul style="list-style-type: none"> ▪ Dimensions: 5³/₄" W x 2¹/₂" D ▪ Metallic Silver or White finish ▪ Two (2) outlets ▪ 108" electrical cord (only length available) ▪ UL Listed 	322
<p>PB3-S (SILVER FINISH) PB3-W (WHITE FINISH)</p> 	<p>Power Band 3</p> <ul style="list-style-type: none"> ▪ Dimensions: 6¹/₂" W x 2¹/₂" D ▪ Metallic Silver or White finish ▪ Two (2) outlets and two (2) USB charging ports ▪ 108" electrical cord (only length available) ▪ UL Listed 	429
<p>PP1</p> 	<p>Portal Power 1</p> <ul style="list-style-type: none"> ▪ Dimensions: 5¹/₄" W x 4¹/₄" D ▪ Touch latch lid with Satin Nickel finish ▪ Unit features one simplex outlet with 72" electrical cord and one RJ-45 jack (Cat 6) with 72" patch cable ▪ 120" length cord available, please specify and add \$30 List ▪ UL listed 	612
<p>PP2</p> 	<p>Portal Power 2</p> <ul style="list-style-type: none"> ▪ Dimensions: 5¹/₄" W x 4¹/₄" D ▪ Touch latch lid with Satin Nickel finish ▪ Unit features two simplex outlets with 72" electrical cord ▪ 120" length cord available, please specify and add \$30 List ▪ UL listed 	542
<p>PP3</p> 	<p>Portal Power 3</p> <ul style="list-style-type: none"> ▪ Dimensions: 5¹/₄" W x 4¹/₄" D ▪ Touch latch lid with Satin Nickel finish ▪ Unit features one simplex outlet with 72" electrical cord and dual USB charging ports ▪ 120" length cord available, please specify and add \$30 List ▪ UL listed 	643

NOTES:

- All units below are corded.
- Cord length should be taken into account when specifying electrical placement.
- Refer to page 13 for power unit standard locations. Please note that placement directly over bases is not available due to the limited opening size.
- For the following technology units, please reference A/V jack combination options below. The price of individual A/V jacks must be added to the Base Model unit price listed below.
- Please contact Customer Service for faceplate/jack combinations that may not be referenced herein.
- Select units show open port positions which, once A/V jacks are purchased, can be reconfigured with different A/V jacks as needed.
- A/V jacks and faceplates snap into opening(s) in metal housing of Base Model units.

WORKSMITH MEETING TABLES

designed by rainlight

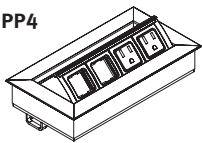
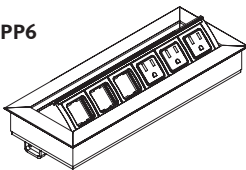
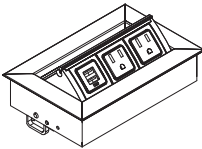
MODEL #	PRODUCT SPECIFICATIONS	LIST
<p>PP4</p> 	<p>Portal Power 4</p> <ul style="list-style-type: none"> ▪ Dimensions: 8⁵/₁₆" W x 4¹/₄" D ▪ Touch latch lid with clear anodized aluminum finish ▪ Two (2) 15 amp simplex outlets and two (2) open ports ▪ 72" electrical cord, no A/V jacks included ▪ 120" length cord available, please specify and add \$30 List ▪ UL Listed 	575
<p>PP6</p> 	<p>Portal Power 6</p> <ul style="list-style-type: none"> ▪ Dimensions: 9¹³/₁₆" W x 4¹/₄" D ▪ Touch latch lid with clear anodized aluminum finish ▪ Three (3) 15 amp simplex outlets and three (3) open ports ▪ 72" electrical cord, no A/V jacks included ▪ 120" length cord available, please specify and add \$30 List ▪ UL Listed 	612
<p>PP7</p> 	<p>Portal Power 7</p> <ul style="list-style-type: none"> ▪ Dimensions: 6³/₄" W x 4³/₈" D ▪ Touch latch lid with clear anodized aluminum finish ▪ Two (2) 15 amp simplex outlets and two (2) USB charging ports ▪ 72" electrical cord ▪ 120" length cord available, please specify and add \$30 List ▪ UL Listed 	665

FACEPLATE CONFIGURATION OPTIONS

ID#	PART #	A/V JACK DESCRIPTION(S)	LIST
1)	Q1	(1) RJ-45 (Cat 5e), punchdown	\$33
2)	Q2	(1) RJ-45 (Cat 6), male/female pre-terminated, 72" long	\$87
3)	Q3	(1) RJ-45 (Cat 6), male/female pre-terminated, 120" long	\$87
4)	Q4	15 pin HD VGA with male/female cable, 72" long	\$87
5)	Q5	15 pin HD VGA with male/female cable, 120" long	\$102
6)	Q6	3.5mm Mini-Stereo jack with male/female cable, 120" long	\$33
7)	Q9	HDMI Corded Coupler, 18" long	\$82

WORKSMITH MEETING TABLES

designed by rainlight

NOTES:

- All units below are corded.
- Cord length should be taken into account when specifying electrical placement.
- Refer to page 13 for power unit standard locations. Please note that placement directly over bases is not available due to the limited opening size.
- For the following technology units, please reference A/V jack combination options below. The price of individual A/V jacks must be added to the Base Model unit price listed below.
- Please contact Customer Service for faceplate/jack combinations that may not be referenced herein.
- Select units show open port positions which, once A/V jacks are purchased, can be reconfigured with different A/V jacks as needed.
- A/V jacks and faceplates snap into opening(s) in metal housing of Base Model units.

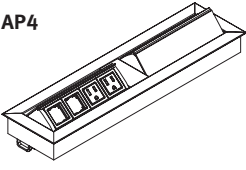
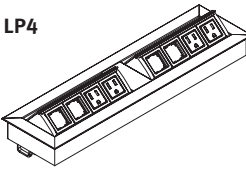
MODEL #	PRODUCT SPECIFICATIONS	LIST
<p>AP4</p> 	<p>Alternate Portal 4</p> <ul style="list-style-type: none"> ▪ Dimensions: 16¹/₂" W x 4¹/₂" D ▪ Touch latch lid with clear anodized aluminum finish ▪ Four (4) 15 amp simplex outlets and four (4) open ports ▪ 72" electrical cord, no A/V jacks included ▪ 120" length cord available, please specify and add \$30 List ▪ UL Listed 	1136
<p>LP4</p> 	<p>Linear Portal</p> <ul style="list-style-type: none"> ▪ Dimensions: 16¹/₂" W x 4¹/₂" D ▪ Touch latch lid with clear anodized aluminum finish ▪ Four (4) 15 amp simplex outlets and four (4) open ports ▪ 72" electrical cord, no A/V jacks included ▪ 120" length cord available, please specify and add \$30 List ▪ UL Listed 	1136

FACEPLATE CONFIGURATION OPTIONS

ID#	PART #	A/V JACK DESCRIPTION(S)	LIST
1)	Q1	(1) RJ-45 (Cat 5e), punchdown	\$33
2)	Q2	(1) RJ-45 (Cat 6), male/female pre-terminated, 72" long	\$87
3)	Q3	(1) RJ-45 (Cat 6), male/female pre-terminated, 120" long	\$87
4)	Q4	15 pin HD VGA with male/female cable, 72" long	\$87
5)	Q5	15 pin HD VGA with male/female cable, 120" long	\$102
6)	Q6	3.5mm Mini-Stereo jack with male/female cable, 120" long	\$33
7)	Q9	HDMI Corded Coupler, 18" long	\$82

NOTES:

- For custom power unit placement, please contact Customer Service to verify location can be accommodated.

WORKSMITH MEETING TABLES

designed by rainlight

POWER UNIT STANDARD LOCATIONS

1 Power Unit

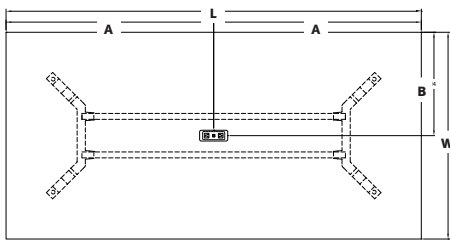

W X L	A	B
32" x 60"	30"	16"
32" x 72"	36"	16"
32" x 84"	42"	16"
32" x 96"	48"	16"
32" x 120"	60"	16"
36" x 72"	36"	18"
36" x 84"	42"	18"
36" x 96"	48"	18"
36" x 120"	60"	18"
42" x 72"	36"	21"
42" x 84"	42"	21"
42" x 96"	48"	21"
42" x 120"	60"	21"
48" x 84"	42"	24"
48" x 96"	48"	24"
48" x 120"	60"	24"
54" x 96"	48"	27"
54" x 120"	60"	27"

2 Power Units

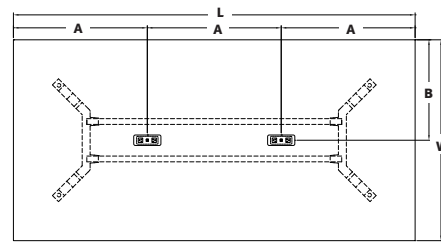

W X L	A	B
32" x 60"	20"	16"
32" x 72"	24"	16"
32" x 84"	28"	16"
32" x 96"	32"	16"
32" x 120"	40"	16"
36" x 72"	24"	18"
36" x 84"	28"	18"
36" x 96"	32"	18"
36" x 120"	40"	18"
42" x 72"	24"	21"
42" x 84"	28"	21"
42" x 96"	32"	21"
42" x 120"	40"	21"
48" x 84"	28"	24"
48" x 96"	32"	24"
48" x 120"	40"	24"
54" x 96"	32"	27"
54" x 120"	40"	27"

WORKSMITH BENCHES

designed by rainlight



NOTES:

- Benches manufactured in Ash wood and offered with planked or non-planked seat.
- 1¹/₈" seat thickness.
- Solid wood seat standard with matching edge.
- Veneer seat offered with self-edge, or exposed plywood edge matched to veneer selection.
- Ash wood legs to match bench seat as standard, unless otherwise specified.
- Ash wood legs are assembled with fabricated metal shoulders in textured matte black finish, and feature adjustable glides.

SPECIFY:

1. Model number
2. Edge detail, as applicable
3. Wood finish
4. Options, as applicable

ORDERING EXAMPLE:

#9105-60-SW-NS02B

60" Length Planked Seat Bench
Solid Wood
Non-Skid Glides

		MODEL NUMBER	SOLID WOOD (-SW)	VENEER SELF EDGE (-SE)	VENEER EXPOSED EDGE (-EP)	WEIGHT
Planked Seat						
	16 W x 48 L x 17 H	9105-48(-)	1381	N/A	N/A	43
	16 W x 60 L x 17 H	9105-60(-)	1671	N/A	N/A	49
	16 W x 72 L x 17 H	9105-72(-)	1911	N/A	N/A	55
Non-Planked Seat						
	16 W x 48 L x 17 H	9106-48(-)	N/A	1325	1325	38
	16 W x 60 L x 17 H	9106-60(-)	N/A	1740	1740	46
	16 W x 72 L x 17 H	9106-72(-)	N/A	1936	1936	48

OPTIONS (XXXX - REFERS TO BENCH MODEL NUMBER)

MODEL	DESCRIPTION	LIST
XXXX-NS02B	Non-Skid Glides	20

NOTES:

- Manufactured in solid Ash wood species.
- Rotate seats to raise or lower to desired height.
- Footring is positioned 11³/₄" from the floor and features textured matte black finish.
- Refer to next page for upholstered seat pad option.

SPECIFY:

1. Model number
2. Wood finish
3. Options, as applicable





ORDERING EXAMPLE:

#9102
18"-24" Stool with Back

WORKSMITH STOOLS

designed by rainlight



			LIST
<p>9101</p> 	<p>18" - 24" Height Stool, Backless W 20 D 20 H 18-24 Seat Height 18-24 Seat Width 14¹/₂ Seat Depth 14¹/₂ 13 lbs.</p>		720
<p>9102</p> 	<p>18" - 24" Height Stool, with Back W 20 D 20 H 28¹/₂-34¹/₂ Seat Height 18-24 Seat Width 14¹/₂ Seat Depth 14¹/₂ 16 lbs.</p>		849
<p>9103</p> 	<p>24" - 30" Height Stool, Backless W 20 D 20 H 24-30 Seat Height 24-30 Seat Width 14¹/₂ Seat Depth 14¹/₂ 14 lbs.</p>		776
<p>9104</p> 	<p>24" - 30" Height Stool, with Back W 20 D 20 H 34¹/₂-40¹/₂ Seat Height 24-30 Seat Width 14¹/₂ Seat Depth 14¹/₂ 17 lbs.</p>		905

WORKSMITH STOOLS

designed by rainlight



NOTES:





- Manufactured in solid Ash wood species.
- Rotate seats to raise or lower to desired height.
- Footring is positioned 11³/₄" from the floor and features textured matte black finish.
- 1/2" thick upholstered seat pad.

SPECIFY:

1. Model number
2. Wood finish
3. Upholstery selection
4. Options, as applicable

ORDERING EXAMPLE:

#9103-91SP
24" - 30" Height Stool
Upholstered Seat Pad

MODEL NUMBER	PRODUCT SPECIFICATIONS	FABRIC GRADES							LEATHER GRADES				
		COM	1	2	3	4	5	6	7	8	L1	L2	L3
9101-91SP 	18" - 24" Height Stool, Backless with Upholstered Seat Pad W 20 D 20 H 18 ¹ / ₂ - 24 ¹ / ₂ Seat Height 18 ¹ / ₂ - 24 ¹ / ₂ Seat Width 14 ¹ / ₂ Seat Depth 14 ¹ / ₂ 1/2 Yd. 15 lbs. COL 10 Sq. Ft.	851	880	887	899	911	922	934	945	958	1013	1053	1092
9102-91SP 	18" - 24" Height Stool, with Back and Upholstered Seat Pad W 20 D 20 H 29-35 Seat Height 18 ¹ / ₂ - 24 ¹ / ₂ Seat Width 14 ¹ / ₂ Seat Depth 14 ¹ / ₂ 1/2 Yd. 18 lbs. COL 10 Sq. Ft.	980	1009	1016	1028	1040	1051	1063	1074	1087	1142	1182	1221
9103-91SP 	24" - 30" Height Stool, Backless with Upholstered Seat Pad W 20 D 20 H 24 ¹ / ₂ - 30 ¹ / ₂ Seat Height 24 ¹ / ₂ - 30 ¹ / ₂ Seat Width 14 ¹ / ₂ Seat Depth 14 ¹ / ₂ 1/2 Yd. 16 lbs. COL 10 Sq. Ft.	907	936	943	955	967	978	990	1001	1014	1069	1109	1148
9104-91SP 	24" - 30" Height Stool, with Back and Upholstered Seat Pad W 20 D 20 H 35-41 Seat Height 24 ¹ / ₂ - 30 ¹ / ₂ Seat Width 14 ¹ / ₂ Seat Depth 14 ¹ / ₂ 1/2 Yd. 19 lbs. COL 10 Sq. Ft.	1036	1065	1072	1084	1096	1107	1119	1130	1143	1198	1238	1277

NOTES:

- Manufactured in Ash.
- Offered with or without doors, as well as open on all sides.
- Fixed legs are die-cast metal with textured matte black finish and includes adjustable glides.

SPECIFY:

1. Model number
2. Wood finish
3. Options, as applicable

ORDERING EXAMPLE:

#9120-24-C-IND
24" Wide Cabinet, Open Casters

WORKSMITH CABINETS

designed by rainlight

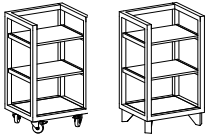
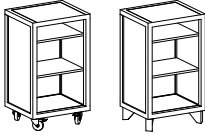
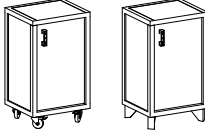

	MODEL NUMBER	PRODUCT SPECIFICATIONS	LIST
	9120-24-C-IND 9120-24-F-IND	<p>Cabinet, Open All Sides Overall Dimensions: 24" W x 22" D x 41¹/₂" H Two fixed shelves 67 lbs.</p> <p>Four self-locking casters Four fixed legs</p>	1925 1975
	9121-24-C-IND 9121-24-F-IND	<p>Cabinet, No Doors Overall Dimensions: 24" W x 22" D x 41¹/₂" H Two adjustable shelves 97 lbs.</p> <p>Four self-locking casters Four fixed legs</p>	2801 2851
	9122-24-C-IND 9122-24-F-IND	<p>Cabinet, Single Door Overall Dimensions: 24" W x 22" D x 41¹/₂" H Two adjustable shelves 107 lbs.</p> <p>Four self-locking casters Four fixed legs</p>	3241 3291

OPTIONS (XXXX - REFERS TO CABINET MODEL NUMBER)

MODEL	DESCRIPTION	LIST
XXXX-DL01A	Door Locks, Single or Double Doors	136
XXXX-TL01A	Touch Latch, Single Door	55
XXXX-NS02B	Non-Skid Glides (fixed leg model)	20

WORKSMITH CABINETS

designed by rainlight



NOTES:



- Manufactured in Ash.
- Offered with or without doors, as well as open on all sides.
- Units can be used independently or double-stacked with other cabinets for additional storage requirements, please refer to next page for top cabinet options.
- When ordered as a stacked combination, the two cabinets will be bolted together and will ship as one unit.
- Fixed legs are cast metal with textured matte black finish and includes adjustables glides.

SPECIFY:

1. Model number
2. Wood finish
3. Options, as applicable

ORDERING EXAMPLE:

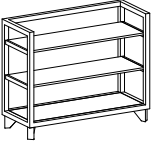
#9121-48-F-IND
48" Wide Cabinet, No Doors
Fixed Legs
Independent Use

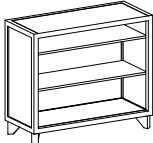
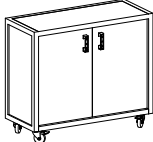
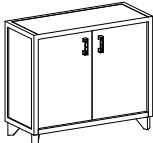
	MODEL NUMBER	PRODUCT SPECIFICATIONS	LIST
		Cabinet, Open All Sides Overall Dimensions: 48" W x 22" D x 41 ¹ / ₂ " H Two fixed shelves 114 lbs.	
	9120-48-C-IND	Four self-locking casters, independent use only	3003
	9120-48-F-IND	Four fixed legs, independent use only	3053
		Cabinet, No Doors Overall Dimensions: 48" W x 22" D x 41 ¹ / ₂ " H Two adjustable shelves 144 lbs.	
	9121-48-C-IND	Four self-locking casters, independent use	4678
	9121-48-C-BOT	Four self-locking casters, stacked use, bottom cabinet placement	4678
	9121-48-F-IND	Four fixed legs, independent use	4728
	9121-48-F-BOT	Four fixed legs, stacked use, bottom cabinet placement	4728
		Cabinet, Double Doors Overall Dimensions: 48" W x 22" D x 41 ¹ / ₂ " H Two adjustable shelves 164 lbs.	
	9122-48-C-IND	Four self-locking casters, independent use	5454
	9122-48-C-BOT	Four self-locking casters, stacked use, bottom cabinet placement	5454
	9122-48-F-IND	Four fixed legs, independent use	5504
	9122-48-F-BOT	Four fixed legs, stacked use, bottom cabinet placement	5504

OPTIONS (XXXX - REFERS TO CABINET MODEL NUMBER)

MODEL	DESCRIPTION	LIST
XXXX-DL01A	Door Locks, Single or Double Doors	136
XXXX-TL01B	Touch Latch, Double Doors	110
XXXX-NS02B	Non-Skid Glides (fixed leg model)	20

NOTES:

- Manufactured in Ash.
- Models intended for stacking purposes, top placement only. Please refer to page 18 for bottom cabinet options.
- Offered with or without doors, as well as open on all sides.
- Metal pulls feature textured matte black finish. Touch latch door option also available, please specify.

SPECIFY:

1. Model number
2. Wood finish
3. Options, as applicable

ORDERING EXAMPLE:

#9122-48-TOP
 48" Wide Cabinet with Doors
 Top Stacked Placement

WORKSMITH CABINETS

designed by rainlight

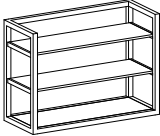
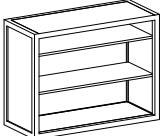
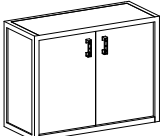

	MODEL NUMBER	PRODUCT SPECIFICATIONS	LIST
	9120-48-TOP	Cabinet, Open All Sides, Stacked Use, Top Cabinet Placement Overall Dimensions: 48" W x 22" D x 36 ³ / ₄ " H Two fixed shelves 112 lbs.	2919
	9121-48-TOP	Cabinet, No Doors, Stacked Use, Top Cabinet Placement Overall Dimensions: 48" W x 22" D x 36 ³ / ₄ " H Two adjustable shelves 142 lbs.	4594
	9122-48-TOP	Cabinet, Double Doors, Stacked Use, Top Cabinet Placement Overall Dimensions: 48" W x 22" D x 36 ³ / ₄ " H Two adjustable shelves 162 lbs.	5370

OPTIONS (XXXX - REFERS TO CABINET MODEL NUMBER)

MODEL	DESCRIPTION	LIST
XXXX-DL01A	Door Locks, Single or Double Doors	136
XXXX-TL01B	Touch Latch, Double Doors	110

WORKSMITH CART

designed by rainlight



NOTES:

- Mobile cart features three open storage compartments.
- Convenient handle and all-black solid rubber tires provide mobility ease.
- Rubber tires feature all-black spokes and rim.
- Available in all standard and custom finishes on Ash, as well as laminate selections.
- Metal frame with textured black finish.

SPECIFY:

1. Model number
2. Wood finish
3. Options, as applicable

ORDERING EXAMPLE:

#9125-NS02A
Cart
Non-Skid Glides

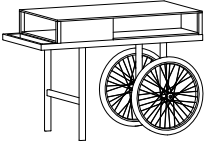
	MODEL NUMBER	PRODUCT SPECIFICATIONS	LIST
	9125	<p>Cart Overall Dimensions: 62" W x 30" D x 41³/₄" H Inside Clearance, Larger Compartment: 32" W x 14¹/₄" D x 7" H Inside Clearance, Smaller Compartment: 27¹/₄" W x 20" D x 7" H 63 lbs.</p>	4833

OPTIONS (XXXX - REFERS TO CART MODEL NUMBER)

MODEL	DESCRIPTION	LIST
XXXX-NS02A	Non-Skid Glides	10



WORKSMITH EASELS

designed by rainlight

PRODUCT FEATURES:

- Vertical and horizontal positioning available.
- Wood frame manufactured in Ash wood species, and features integrated channel for storing markers, pushpins, magnets and similar accessories.
- All standard and custom wood finishes available.
- For custom wood finishes, please add one-time upcharge of \$400 List per color per order.
- Material options include whiteboard, upholstered with tackable surface or magnetic glass, in any combination.
- Magnetic glass is back-painted white and may be used as a writable surface with dry-erase markers.
- Vinyl, polyurethane and leather upholstery not available.
- Due to standard textile widths, upholstery for the 63" wide easel will always be railroaded.
- Center section (portion between panels) features exposed plywood trim, finished to match wood frame.
- Metal base features textured black finish and four locking casters.

WORKSMITH EASELS

designed by rainlight



NOTES:

- Whiteboard or magnetic glass surface options. Please specify appropriate material code for each side.
- Metal base features textured matte black finish and four locking casters.

SPECIFY:

1. Model number
2. Material selection

ORDERING EXAMPLE:

#9130-W-G
Vertical Easel
Whiteboard One Side
Magnetic Glass Other Side

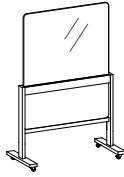
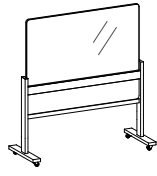
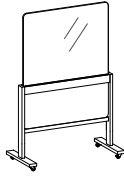
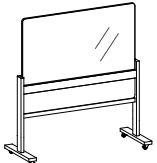
MODEL NUMBER	PRODUCT SPECIFICATIONS	EASEL MATERIAL	
		WHITEBOARD (-W)	MAGNETIC GLASS (-G)
9130-()-() 	Vertical Easel, Same Material Both Sides W 53 D 25 ¹ / ₂ H 80 Surface Area 47" Wide Panel Thickness 3/4" 82 lbs.	3075	4722
9131-()-() 	Horizontal Easel, Same Material Both Sides W 65 ¹ / ₂ D 25 ¹ / ₂ H 72 Surface Area 60" Wide Panel Thickness 3/4" 92 lbs.	3241	4897
LIST			
9130-W-M 	Vertical Easel Whiteboard/Magnetic Glass Combination W 53 D 25 ¹ / ₂ H 80 Surface Area 47" Wide Panel Thickness 3/4" 102 lbs.	4340	
9131-W-M 	Horizontal Easel Whiteboard/Magnetic Glass Combination W 65 ¹ / ₂ D 25 ¹ / ₂ H 72 Surface Area 60" Wide Panel Thickness 3/4" 112 lbs.	4514	

NOTES:

- Upholstered with tackable surface on one side and whiteboard or magnetic glass on the other.
- Vinyl, polyurethane and leather upholstery not available.
- Due to standard textile widths, upholstery for the 63" wide easel will always be railroaded.
- Metal base features textured matte black finish and four locking casters.

SPECIFY:

1. Model number
2. Surface material
3. Upholstery selection

ORDERING EXAMPLE:

#9131-U-W

Horizontal Easel
Tackable Fabric One Side
Whiteboard Other Side

WORKSMITH EASELS

designed by rainlight

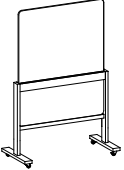
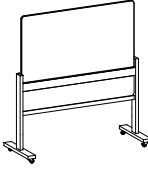

MODEL NUMBER	PRODUCT SPECIFICATIONS	FABRIC GRADES									
		COM	1	2	3	4	5	6	7	8	
9130-U(-) 	Vertical Easel Upholstered Panel, Single Side W 53 D 25 ¹ / ₂ H 80 Surface Area 47" Wide Panel Thickness ³ / ₄ " 2 ¹ / ₄ Yds. 82 lbs.	Whiteboard (-W)	3251	3379	3410	3464	3518	3570	3625	3674	3729
		Magnetic Glass (G)	4127	4255	4286	4340	4394	4446	4501	4550	4605
9131-U(-) 	Horizontal Easel Upholstered Panel, Single Side W 65 ¹ / ₂ D 25 ¹ / ₂ H 72 Surface Area 60" Wide Panel Thickness ³ / ₄ " 2 ¹ / ₄ Yds. 92 lbs.	Whiteboard (-W)	3417	3545	3576	3630	3684	3736	3791	3840	3895
		Magnetic Glass (G)	4087	4215	4246	4300	4354	4406	4461	4510	4565

WORKSMITH EASELS

designed by rainlight



NOTES:

- Upholstered with tackable surface on both sides.
- Vinyl, polyurethane and leather upholstery not available.
- Due to standard textile widths, upholstery for the 63" wide easel will always be railroaded.
- Metal base features textured matte black finish and four locking casters.

SPECIFY:

1. Model number
2. Upholstery selection

ORDERING EXAMPLE:

#9130-U-U
Vertical Easel

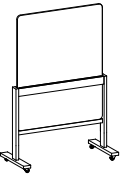
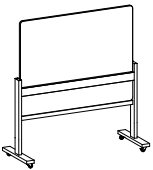
MODEL NUMBER	PRODUCT SPECIFICATIONS	FABRIC GRADES								
		COM	1	2	3	4	5	6	7	8
<p>9130-U-U</p> 	<p>Vertical Easel Upholstered Panel, Both Sides W 53 D 25¹/₂ H 80 Surface Area 47" Wide Panel Thickness 3/4" 4¹/₂ Yds. 82 lbs.</p>	3349	3605	3666	3775	3883	3987	4096	4195	4304
<p>9131-U-U</p> 	<p>Horizontal Easel Upholstered Panel, Both Sides W 65¹/₂ D 25¹/₂ H 72 Surface Area 60" Wide Panel Thickness 3/4" 4¹/₂ Yds. 92 lbs.</p>	3514	3770	3831	3940	4048	4152	4261	4360	4469