

ACHELLA SEATING



arcadia

MARCH 1, 2026
VA IDIQ CONTRACT (FY26)
(DEALER HELD)

ACHELLA LOUNGE // DESIGNED BY CHRIS PANICHELLA



PRODUCT FEATURES:

- » Standard base configuration includes maple wood platform with fixed metal legs or casters.
- » Metal legs are 5" high cast aluminum.
- » Mobile version comes standard with two locking casters in rear and two non-locking casters in front. Caster finish is silver as standard. Black casters available at no upcharge, please specify.
- » Maximum weight capacity is 350 lbs. for lounge chairs, 700 lbs. for love seats and 1000 lbs. for sofas.
- » All dimensions are nominal.

ROTATING TABLET:

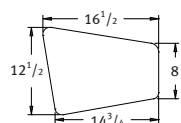

Tablet Shape

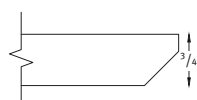

Veneer/Laminate Top - Edge Profile

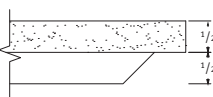

Corian Top - Edge Profile

- » Rotating tablet affixed to right arm or left arm, as specified.
- » Tablet size is $16\frac{1}{2}$ " W x $12\frac{1}{2}$ " D x $\frac{3}{4}$ " thick and features 180-degree turning radius.
- » Three tablet surface options: maple veneer, laminate or Corian.
- » For custom laminates, add \$642 List per color per order. Pre-approval required, please contact client services.
- » For maximum durability, a laminate or Corian surface with a clear coat edge finish is recommended.
- » Refer to Terms and Conditions for edge finish details.

CUP HOLDER:

- » Dimensions: 5" diameter.
- » Cup holder will be mounted to right side, as seated, unless otherwise specified.
- » If specified in conjunction with a tablet, cup holder will be mounted to opposite side, unless otherwise specified.
- » Cup holder finish is 0299 Polished Aluminum, with black laminate insert.

ACHELLA LOUNGE // DESIGNED BY CHRIS PANICHELLA

POWER UNITS:

- » Affixed to right side, as seated, unless otherwise specified.
- » If specified in conjunction with a tablet, power unit will be mounted to same side as tablet, unless otherwise specified.
- » Black or white finish with 120" electrical cord (no hardwire option available for this series).
- » Power units not available on mobile units.
- » UL listed.



PX1
5¹/₄" W x 2¹/₂" D
One outlet, one USB-A and one USB-C charging port

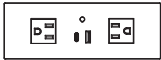

PX2
6⁵/₈" W x 2¹/₂" D
Two outlets, one USB-A and one USB-C charging port

SPECIFICATIONS:

- » Wood platform and veneer rotating tablet available in all standard and custom wood finishes on maple.
- » For Super Matte Sable Maple, premium wood finish upcharge applies. Refer to options section for pricing.
- » For custom wood finishes to platform and/or tablet, please add one-time upcharge of \$514 List per color per order.
- » Metal legs available in three finishes.

METAL LEG FINISHES:

- » 0299 Polished Aluminum
- » 0535 Metallic Silver
- » 0630 Satin Black

CORIAN® COLORS:

- » CWN Designer White
- » CLN Linen
- » CTD Witch Hazel
- » CRC Rain Cloud
- » CGQ Grey Onyx
- » CSQ Stonique



ORDERING REQUIREMENTS:

- » Model number
- » Wood platform finish
- » Metal leg finish
- » Upholstery selection
- » Options, as applicable

ACHELLA LOUNGE // DESIGNED BY CHRIS PANICHELLA

ORDERING REQUIREMENTS:

- » Model number
- » Upholstery selection
- » Wood platform finish
- » Options, as applicable
- » Metal leg finish

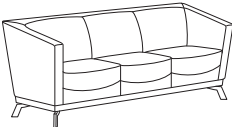
MODEL NUMBER	PRODUCT SPECIFICATIONS	FABRIC GRADES										LEATHER			
		COM	A	1	2	COL		3	4	5	6	7	8	L1	L2
2701	 <p>Lounge Chair W 31¹/₂ D 28 H 32 Seat Height 18 Inside Seat Width 22¹/₂ Inside Seat Depth 18¹/₂ Arm Height 29¹/₂ 4¹/₂ yds. 59 lbs. COL 90 sq. ft.</p>	2508	2801	2945	3035	3179	3336	3485	3633	3773	3939	4619	5136		
2702	 <p>Love Seat W 53 D 28 H 32 Seat Height 18 Inside Seat Width 44 Inside Seat Depth 18¹/₂ Arm Height 29¹/₂ 6³/₄ yds. 90 lbs. COL 135 sq. ft.</p>	3453	3892	4108	4243	4459	4695	4918	5141	5350	5600	6619	7395		
2703	 <p>Sofa W 75¹/₂ D 28 H 32 Seat Height 18 Inside Seat Width 66¹/₂ Inside Seat Depth 18¹/₂ Arm Height 29¹/₂ 8 yds. 115 lbs. COL 160 sq. ft.</p>	4332	4852	5108	5268	5524	5804	6068	6332	6580	6876	8084	9004		

OPTIONS		
-TAR02	Veneer/Laminate Rotating Tablet, Right (as seated)	539
-TAL02	Veneer/Laminate Rotating Tablet, Left (as seated)	539
-TAR02-CO	Corian Rotating Tablet, Right (as seated)	877
-TAL02-CO	Corian Rotating Tablet, Left (as seated)	877
-PX1(-)	Power Matrix 1 (one power, one USB-A, one USB-C)	514
-PX2(-)	Power Matrix 2 (dual power, one USB-A, one USB-C)	538
-CHR02	Cup Holder, Right (as seated)	263
-CHL02	Cup Holder, Left (as seated)	263
-PFW01	Premium Wood Finish, Rotating Tablet	12
-PFW02	Premium Wood Finish, Platform	22
-NS04	Non-Skid Glides	29

Note: For power matrix faceplate, please specify black (-B) or white (-W) finish.

ACHELLA LOUNGE // DESIGNED BY CHRIS PANICHELLA

ORDERING REQUIREMENTS:

- » Model number
- » Wood platform finish
- » Upholstery selection
- » Options, as applicable

MODEL NUMBER	PRODUCT SPECIFICATIONS	FABRIC GRADES										LEATHER	
		COM	A	1	2	COL 3	4	5	6	7	8	L1	L2
2721	 <p>Lounge Chair, Casters W 31¹/₂ D 28 H 32 Seat Height 18 Inside Seat Width 22¹/₂ Inside Seat Depth 18¹/₂ Arm Height 29¹/₂ 4¹/₂ yds. 59 lbs. COL 90 sq. ft.</p>	2508	2801	2945	3035	3179	3336	3485	3633	3773	3939	4619	5136

OPTIONS

-TAR02	Veneer/Laminate Rotating Tablet, Right (as seated)	539
-TAL02	Veneer/Laminate Rotating Tablet, Left (as seated)	539
-TAR02-CO	Corian Rotating Tablet, Right (as seated)	877
-TAL02-CO	Corian Rotating Tablet, Left (as seated)	877
-CHR02	Cup Holder, Right (as seated)	263
-CHL02	Cup Holder, Left (as seated)	263
-PFW01	Premium Wood Finish, Rotating Tablet	12
-PFW02	Premium Wood Finish, Platform	22
-STC02	Soft Tread Casters, Silver	67

ACHELLA LOUNGE // DESIGNED BY CHRIS PANICHELLA

UPHOLSTERY COMBINATIONS:

- » When combining two COM/COV/COL fabrics, or fabrics with the same grade, add \$120 List per unit.
- » When combining three COM/COV/COL fabrics, or fabrics with the same grade, add \$150 List per unit.
- » When combining different grades of fabric, price will be based on the highest grade specified.
- » Two-tone upholstery examples and yardage requirements for the most common combinations are listed below. Additional combinations available, please contact client services for yardage requirements and pricing.
- » Note: Yardage amounts are based on fabric which is plain (i.e. non-directional) and a full 54" wide.
- » Appropriate upholstery code must be included.

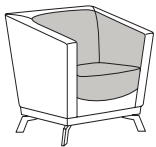

Code AC1

Model COM Requirement
 2701 Inside Back/Inside Arms/
 2721 Seat Cushion = 2 yds.
 Balance of Chair = 2¹/₂ yds.

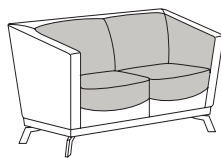

Code AC2

Model COM Requirement
 2702 Inside Back/Inside Arms/
 Seat Cushion = 3¹/₂ yds.
 Balance of Love Seat = 3³/₄ yds.

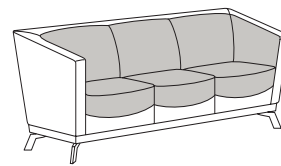

Code AC3

Model COM Requirement
 2703 Inside Back/Inside Arms/
 Seat Cushion = 5 yds.
 Balance of Sofa = 4 yds.

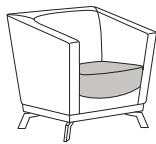

Code AC4

Model COM Requirement
 2701 Seat Cushion Only = 1 yd.
 2721 Balance of Chair = 3³/₄ yds.

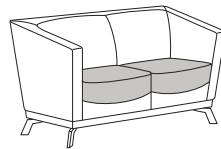

Code AC5

Model COM Requirement
 2702 Seat Cushion Only = 2 yds.
 Balance of Love Seat = 4³/₄ yds.

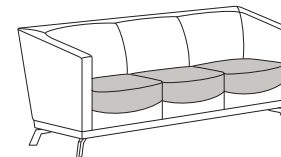

Code AC6

Model COM Requirement
 2703 Seat Cushion Only = 3 yds.
 Balance of Sofa = 6 yds.

ACHELLA MODULAR // DESIGNED BY CHRIS PANICHELLA



PRODUCT FEATURES:

- » Lounge chairs available in two back heights: 29¹/₂" or 32¹/₂".
- » Maximum weight capacity is 350 lbs.
- » Tables available in five sizes; benches available in three sizes.
- » All models feature 5" high cast aluminum legs.
- » All dimensions are nominal.

SEATING POWER UNITS:

- » Units available on the side of arms and for armless seat end models, on the side of the seat. Specify left or right, as seated.
- » Black or white finish with 120" electrical cord (no hardwire option available for this series).
- » UL listed.



PX1
5¹/₄" W x 2¹/₂" D
One outlet, one USB-A and one USB-C charging port



PX2
6⁵/₈" W x 2¹/₂" D
Two outlets, one USB-A and one USB-C charging port

TABLE POWER UNITS:

- » Available on all table sizes.
- » Black or white finish with 120" electrical cord (no hardwire option available for this series).
- » UL listed.

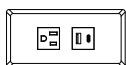

PX3
5⁷/₈" W x 2⁷/₈" D
One outlet, one USB-A and one USB-C charging port



PX4
7¹/₄" W x 2⁷/₈" D
Two outlets, one USB-A and one USB-C charging port

ACHELLA MODULAR // DESIGNED BY CHRIS PANICHELLA

GANGING BRACKET:

- » One set contains two brackets for connecting two units together.
- » Field assembly required.

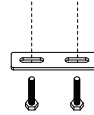

SPECIFICATIONS:

- » Upholstery direction must be specified on 90-degree benches when patterned fabrics are selected. In the absence of specific instructions, Arcadia reserves the right to upholster units at our discretion.

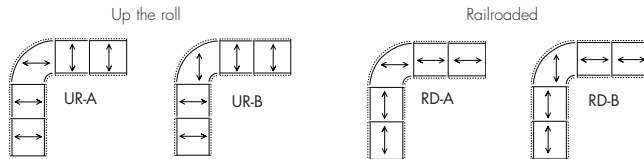

- » Tables available in maple veneer, laminate and Corian.
- » All standard and custom wood finishes available.
- » For Super Matte Sable Maple, premium wood finish upcharge applies. Refer to options section for pricing.
- » For custom wood finishes, please add one-time upcharge of \$514 List per color per order.
- » For custom laminates, add \$642 List per color per order. Pre-approval required, please contact client services.
- » Corian top available in six standard colors and is 1/2" thick in lieu of standard table top thickness of 3/4". For non-standard colors, please contact client services for pricing.
- » **Table with laminate or Corian top, finish selection for table body must be specified.**

STANDARD METAL LEG FINISHES:

- » 0299 Polished Aluminum
- » 0405 Charcoal Grey
- » 0535 Metallic Silver
- » 0630 Satin Black

PREMIUM METAL LEG FINISHES:

- » 0605 Matte Black
- » 0705 Matte Cotton
- » 0788 Glossy Cotton
- » 0805 Oasis
- » 0905 Mint
- » 1005 Mercury
- » 1105 Canary
- » 1205 Stone
- » 1305 Sage
- » 1405 Ice Blue
- » 1505 Clay

CORIAN® COLORS:

- » CWN Designer White
- » CLN Linen
- » CTD Witch Hazel
- » CRC Rain Cloud
- » CGQ Grey Onyx
- » CSQ Stonique



ORDERING REQUIREMENTS:

- » Model number
- » Leg finish
- » Upholstery selection
- » Options, as applicable

ACHELLA MODULAR // DESIGNED BY CHRIS PANICHELLA

ORDERING REQUIREMENTS:

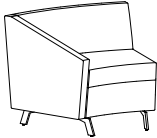
- » Model number
- » Metal leg finish
- » Upholstery selection
- » Options, as applicable

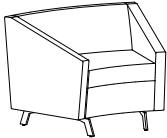
MODEL NUMBER	PRODUCT SPECIFICATIONS	FABRIC GRADES										LEATHER			
		COM	A	1	2	COL		3	4	5	6	7	8	L1	L2
1003.11.04.ANA 	Lounge Chair, Armless 30-Degree Inside Wedge W 35 ¹ / ₂ D 29 ¹ / ₄ H 29 ¹ / ₂ Seat Height 18 Inside Seat Width 21 ¹ / ₂ - 32 Inside Seat Depth 21 ¹ / ₄ 3 ¹ / ₄ yds. 39 lbs. COL 65 sq. ft.	1895	2107	2211	2276	2380	2493	2601	2708	2809	2929	3420	3793		
1003.11.04.ARA 	Lounge Chair, Right Arm 30-Degree Inside Wedge W 38 ¹ / ₄ D 30 ¹ / ₂ H 29 ¹ / ₂ Seat Height 18 Inside Seat Width 21 ¹ / ₂ - 32 Inside Seat Depth 21 ¹ / ₄ Arm Height 25 ³ / ₄ 4 ¹ / ₂ yds. 52 lbs. COL 90 sq. ft.	2204	2497	2641	2731	2875	3032	3181	3329	3469	3635	4315	4832		
1003.11.04.ALA 	Lounge Chair, Left Arm 30-Degree Inside Wedge W 38 ¹ / ₄ D 30 ¹ / ₂ H 29 ¹ / ₂ Seat Height 18 Inside Seat Width 21 ¹ / ₂ - 32 Inside Seat Depth 21 ¹ / ₄ Arm Height 25 ³ / ₄ 4 ¹ / ₂ yds. 52 lbs. COL 90 sq. ft.	2204	2497	2641	2731	2875	3032	3181	3329	3469	3635	4315	4832		
1003.11.04.ALR 	Lounge Chair, Right & Left Arm 30-Degree Inside Wedge W 41 D 30 ¹ / ₂ H 29 ¹ / ₂ Seat Height 18 Inside Seat Width 21 ¹ / ₂ - 32 Inside Seat Depth 21 ¹ / ₄ Arm Height 25 ³ / ₄ 5 ¹ / ₄ yds. 65 lbs. COL 105 sq. ft.	2467	2809	2977	3082	3250	3433	3607	3780	3943	4137	4930	5533		

OPTIONS		
-NS04	Non-Skid Glides	29
-GC01 (ordered separately)	Ganging Connector	69

ACHELLA MODULAR // DESIGNED BY CHRIS PANICHELLA

ORDERING REQUIREMENTS:

- » Model number
- » Metal leg finish
- » Upholstery selection
- » Options, as applicable

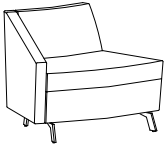
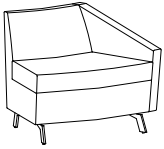
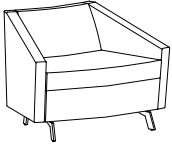
MODEL NUMBER	PRODUCT SPECIFICATIONS	FABRIC GRADES										LEATHER	
		COM	A	1	2	COL		3	4	5	6	7	8
1003.11.05.ANA 	Lounge Chair, Armless 30-Degree Outside Wedge W 35 D 29 ¹ / ₂ H 29 ¹ / ₂ Seat Height 18 Inside Seat Width 35-24 ¹ / ₄ Inside Seat Depth 22 ¹ / ₄ 3 yds. 39 lbs. COL 60 sq. ft.	1969	2164	2260	2320	2416	2521	2620	2719	2812	2923	3376	3721
1003.11.05.ARA 	Lounge Chair, Right Arm 30-Degree Outside Wedge W 37 ³ / ₄ D 30 ¹ / ₄ H 29 ¹ / ₂ Seat Height 18 Inside Seat Width 35-24 ¹ / ₄ Inside Seat Depth 23 ¹ / ₄ Arm Height 25 ³ / ₄ 4 yds. 52 lbs. COL 80 sq. ft.	2282	2542	2670	2750	2878	3018	3150	3282	3406	3554	4158	4618
1003.11.05.ALA 	Lounge Chair, Left Arm 30-Degree Outside Wedge W 37 ³ / ₄ D 30 ¹ / ₄ H 29 ¹ / ₂ Seat Height 18 Inside Seat Width 35-24 ¹ / ₄ Inside Seat Depth 24 ¹ / ₄ Arm Height 25 ³ / ₄ 4 yds. 52 lbs. COL 80 sq. ft.	2282	2542	2670	2750	2878	3018	3150	3282	3406	3554	4158	4618
1003.11.05.ALR 	Lounge Chair, Right & Left Arm 30-Degree Outside Wedge W 40 ¹ / ₂ D 30 ¹ / ₄ H 29 ¹ / ₂ Seat Height 18 Inside Seat Width 35-24 ¹ / ₄ Inside Seat Depth 25 ¹ / ₄ Arm Height 25 ³ / ₄ 5 ¹ / ₄ yds. 65 lbs. COL 105 sq. ft.	2593	2935	3103	3208	3376	3559	3733	3906	4069	4263	5056	5659

OPTIONS		
-NS04	Non-Skid Glides	29
-GC01 (ordered separately)	Ganging Connector	69

ACHELLA MODULAR // DESIGNED BY CHRIS PANICHELLA

ORDERING REQUIREMENTS:

- » Model number
- » Metal leg finish
- » Upholstery selection
- » Options, as applicable

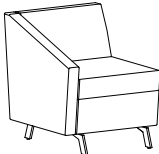
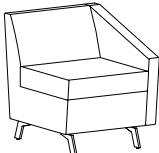
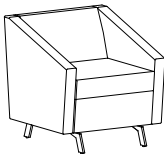
MODEL NUMBER	PRODUCT SPECIFICATIONS	FABRIC GRADES										LEATHER	
		COM	A	1	2	COL		3	4	5	6	7	8
1003.11.06.ANA 	Lounge Chair, Armless Straight W 22 ¹ / ₄ D 28 ¹ / ₄ H 29 ¹ / ₂ Seat Height 18 Inside Seat Width 22 ¹ / ₄ Inside Seat Depth 21 2 ¹ / ₂ yds. 32 lbs. COL 50 sq. ft.	1814	1977	2057	2107	2187	2274	2357	2439	2517	2609	2987	3274
1003.11.06.ARA 	Lounge Chair, Right Arm Straight W 25 D 28 ¹ / ₂ H 29 ¹ / ₂ Seat Height 18 Inside Seat Width 22 ¹ / ₄ Inside Seat Depth 21 Arm Height 25 ³ / ₄ 3 ¹ / ₂ yds. 46 lbs. COL 70 sq. ft.	2123	2351	2463	2533	2645	2767	2883	2998	3107	3236	3765	4167
1003.11.06.ALA 	Lounge Chair, Left Arm Straight W 25 D 28 ¹ / ₂ H 29 ¹ / ₂ Seat Height 18 Inside Seat Width 22 ¹ / ₄ Inside Seat Depth 21 Arm Height 25 ³ / ₄ 3 ¹ / ₂ yds. 46 lbs. COL 70 sq. ft.	2123	2351	2463	2533	2645	2767	2883	2998	3107	3236	3765	4167
1003.11.06.ALK 	Lounge Chair, Right & Left Arm Straight W 27 ¹ / ₄ D 28 ¹ / ₂ H 29 ¹ / ₂ Seat Height 18 Inside Seat Width 22 ¹ / ₄ Inside Seat Depth 21 Arm Height 25 ³ / ₄ 4 ¹ / ₄ yds. 60 lbs. COL 85 sq. ft.	2387	2664	2800	2885	3021	3169	3310	3450	3582	3739	4381	4869

OPTIONS		
-NS04	Non-Skid Glides	29
-GC01 (ordered separately)	Ganging Connector	69

ACHELLA MODULAR // DESIGNED BY CHRIS PANICHELLA

ORDERING REQUIREMENTS:

- » Model number
- » Metal leg finish
- » Upholstery selection
- » Options, as applicable

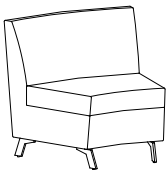
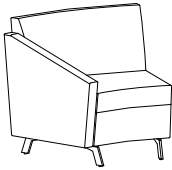
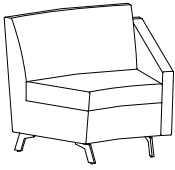
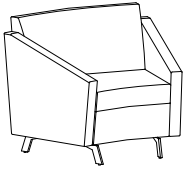

MODEL NUMBER	PRODUCT SPECIFICATIONS	FABRIC GRADES										LEATHER			
		COM	A	1	2	COL			3	4	5	6	7	8	L1
1003.11.07.ANA 	High Back Lounge Chair, Armless 30-Degree Inside Wedge W 35 ³ / ₄ D 29 ¹ / ₄ H 32 ¹ / ₂ Seat Height 18 Inside Seat Width 21 ¹ / ₂ - 32 Inside Seat Depth 21 ¹ / ₄ 3 ³ / ₄ yds. 39 lbs. COL 75 sq. ft.	2011	2255	2375	2450	2570	2701	2825	2949	3065	3204	3770	4201		
1003.11.07.ARA 	High Back Lounge Chair, Right Arm 30-Degree Inside Wedge W 38 ¹ / ₄ D 31 H 32 ¹ / ₂ Seat Height 18 Inside Seat Width 21 ¹ / ₂ - 32 Inside Seat Depth 21 ¹ / ₄ Arm Height 25 ³ / ₄ 4 ³ / ₄ yds. 52 lbs. COL 95 sq. ft.	2276	2585	2737	2832	2984	3150	3307	3464	3611	3787	4504	5050		
1003.11.07.ALA 	High Back Lounge Chair, Left Arm 30-Degree Inside Wedge W 38 ¹ / ₄ D 31 H 32 ¹ / ₂ Seat Height 18 Inside Seat Width 21 ¹ / ₂ - 32 Inside Seat Depth 21 ¹ / ₄ Arm Height 25 ³ / ₄ 4 ³ / ₄ yds. 52 lbs. COL 95 sq. ft.	2276	2585	2737	2832	2984	3150	3307	3464	3611	3787	4504	5050		
1003.11.07.ALR 	High Back Lounge Chair, Right & Left Arm, 30-Degree Inside Wedge W 41 D 31 H 32 ¹ / ₂ Seat Height 18 Inside Seat Width 21 ¹ / ₂ - 32 Inside Seat Depth 21 ¹ / ₄ Arm Height 25 ³ / ₄ 5 ¹ / ₂ yds. 65 lbs. COL 110 sq. ft.	2583	2941	3117	3227	3403	3595	3777	3958	4129	4332	5163	5795		

OPTIONS		
-NS04	Non-Skid Glides	29
-GC01 (ordered separately)	Ganging Connector	69

ACHELLA MODULAR // DESIGNED BY CHRIS PANICHELLA

ORDERING REQUIREMENTS:

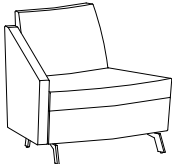
- » Model number
- » Metal leg finish
- » Upholstery selection
- » Options, as applicable

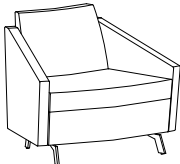

MODEL NUMBER	PRODUCT SPECIFICATIONS	FABRIC GRADES										LEATHER			
		COM	A	1	2	COL		3	4	5	6	7	8	L1	L2
1003.11.08.ANA 	High Back Lounge Chair, Armless 30-Degree Outside Wedge W 35 D 30 H 32 ¹ / ₂ Seat Height 18 Inside Seat Width 35-24 ¹ / ₄ Inside Seat Depth 22 ¹ / ₄ 3 yds. 39 lbs. COL 60 sq. ft.	2086	2281	2377	2437	2533	2638	2737	2836	2929	3040	3493	3838		
1003.11.08.ARA 	High Back Lounge Chair, Right Arm 30-Degree Outside Wedge W 37 ³ / ₄ D 30 ¹ / ₄ H 32 ¹ / ₂ Seat Height 18 Inside Seat Width 35-24 ¹ / ₄ Inside Seat Depth 23 ¹ / ₄ Arm Height 25 ³ / ₄ 4 ¹ / ₄ yds. 52 lbs. COL 85 sq. ft.	2242	2519	2655	2740	2876	3024	3165	3305	3437	3594	4236	4724		
1003.11.08.ALA 	High Back Lounge Chair, Left Arm 30-Degree Outside Wedge W 37 ³ / ₄ D 30 ¹ / ₄ H 32 ¹ / ₂ Seat Height 18 Inside Seat Width 35-24 ¹ / ₄ Inside Seat Depth 24 ¹ / ₄ Arm Height 25 ³ / ₄ 4 ¹ / ₄ yds. 52 lbs. COL 85 sq. ft.	2242	2519	2655	2740	2876	3024	3165	3305	3437	3594	4236	4724		
1003.11.08.ALR 	High Back Lounge Chair, Right & Left Arm, 30-Degree Outside Wedge W 40 ¹ / ₂ D 30 ¹ / ₄ H 32 ¹ / ₂ Seat Height 18 Inside Seat Width 35-24 ¹ / ₄ Inside Seat Depth 25 ¹ / ₄ Arm Height 25 ³ / ₄ 5 ³ / ₄ yds. 65 lbs. COL 115 sq. ft.	2652	3026	3210	3325	3509	3710	3900	4090	4268	4481	5349	6010		

OPTIONS		
-NS04	Non-Skid Glides	29
-GC01 (ordered separately)	Ganging Connector	69

ACHELLA MODULAR // DESIGNED BY CHRIS PANICHELLA

ORDERING REQUIREMENTS:

- » Model number
- » Metal leg finish
- » Upholstery selection
- » Options, as applicable

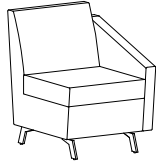
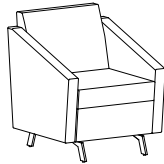

MODEL NUMBER	PRODUCT SPECIFICATIONS	FABRIC GRADES										LEATHER			
		COM	A	1	2	COL		3	4	5	6	7	8	L1	L2
1003.11.09.ANA 	High Back Lounge Chair, Armless Straight W 35 D 28 ¹ / ₂ H 32 ¹ / ₂ Seat Height 18 Inside Seat Width 22 ¹ / ₄ Inside Seat Depth 21 2 ¹ / ₂ yds. 32 lbs. COL 50 sq. ft.	1928	2091	2171	2221	2301	2388	2471	2553	2631	2723	3101	3388		
1003.11.09.ARA 	High Back Lounge Chair, Right Arm Straight W 37 ³ / ₄ D 28 ³ / ₄ H 32 ¹ / ₂ Seat Height 18 Inside Seat Width 22 ¹ / ₄ Inside Seat Depth 21 Arm Height 25 ³ / ₄ 3 ¹ / ₂ yds. 46 lbs. COL 70 sq. ft.	2198	2426	2538	2608	2720	2842	2958	3073	3182	3311	3840	4242		
1003.11.09.ALA 	High Back Lounge Chair, Left Arm Straight W 37 ³ / ₄ D 28 ³ / ₄ H 32 ¹ / ₂ Seat Height 18 Inside Seat Width 22 ¹ / ₄ Inside Seat Depth 21 Arm Height 25 ³ / ₄ 3 ¹ / ₂ yds. 46 lbs. COL 70 sq. ft.	2198	2426	2538	2608	2720	2842	2958	3073	3182	3311	3840	4242		
1003.11.09.ALR 	High Back Lounge Chair, Right & Left Arm, Straight W 40 ¹ / ₂ D 28 ³ / ₄ H 32 ¹ / ₂ Seat Height 18 Inside Seat Width 22 ¹ / ₄ Inside Seat Depth 21 Arm Height 25 ³ / ₄ 4 ¹ / ₂ yds. 60 lbs. COL 90 sq. ft.	2502	2795	2939	3029	3173	3330	3479	3627	3767	3933	4613	5130		

OPTIONS		
-NS04	Non-Skid Glides	29
-GC01 (ordered separately)	Ganging Connector	69

ACHELLA MODULAR // DESIGNED BY CHRIS PANICHELLA

ORDERING REQUIREMENTS:

- » Model number
- » Metal leg finish
- » Upholstery selection
- » Options, as applicable

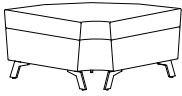
MODEL NUMBER	PRODUCT SPECIFICATIONS	FABRIC GRADES										LEATHER			
		COM	A	1	2	COL			3	4	5	6	7	8	L1
1003.11.10 	Straight Bench W 22 D 26 ³ / ₄ H 18 Seat Height 18 1 ³ / ₄ yds. 30 lbs. COL 35 sq. ft.	1509	1591	1631	1656	1696	1739	1781	1822	1861	1907	2096	2239		
1003.11.11 	30-Degree Bench W 22 ¹ / ₂ - 36 ³ / ₄ D 26 ³ / ₄ H 18 Seat Height 18 2 ¹ / ₂ yds. 30 lbs. COL 50 sq. ft.	1711	1874	1954	2004	2084	2171	2254	2336	2414	2506	2884	3171		
1003.11.12 	90-Degree Bench W 34 D 26 ³ / ₄ H 18 Seat Height 18 3 yds. 30 lbs. COL 60 sq. ft.	2117	2312	2408	2468	2564	2669	2768	2867	2960	3071	3524	3869		



OPTIONS		
-NS04	Non-Skid Glides	29
-GC01 (ordered separately)	Ganging Connector	69

ACHELLA MODULAR // DESIGNED BY CHRIS PANICHELLA

ORDERING REQUIREMENTS:

- » Model number
- » Wood finish
- » Metal leg finish
- » Options, as applicable

Note: Table with laminate or Corian top, finish selection for table body must be specified.

MODEL NUMBER	PRODUCT SPECIFICATIONS	TABLE TOP FINISH	
		VENEER OR LAMINATE	CORIAN (-CO)
<p>1003.20.13</p> 	<p>12" Straight Table W 12 D 25¹/₄ H 16 27 lbs.</p>	1521	1986
<p>1003.20.14</p> 	<p>22" Straight Table W 22 D 25¹/₄ H 16 43 lbs.</p>	1850	2806

OPTIONS		
-PFW04	Premium Wood Finish	44
-PX3-()	Power Matrix 3 (one power, one USB-A, one USB-C)	514
-PX4-()	Power Matrix 4 (dual power, one USB-A, one USB-C)	538
-NS04	Non-Skid Glides	29
-GC01 (ordered separately)	Ganging Connector	69



Note: For power matrix faceplate, please specify black (-B) or white (-W) finish.

ACHELLA MODULAR // DESIGNED BY CHRIS PANICHELLA

ORDERING REQUIREMENTS:

- » Model number
- » Wood finish
- » Metal leg finish
- » Options, as applicable

Note: Table with laminate or Corian top, finish selection for table body must be specified.

MODEL NUMBER	PRODUCT SPECIFICATIONS	TABLE TOP FINISH	
		VENEER OR LAMINATE	CORIAN (-CO)
1003.20.15 	30-Degree Narrow Table W 20 D 25 ¹ / ₂ H 16 28 lbs.	1776	2727
1003.20.16 	30-Degree Wide Table W 28 D 25 ¹ / ₂ H 16 37 lbs.	2106	3302
1003.20.17 	90-Degree Table W 43 D 23 H 16 47 lbs.	2299	4299

OPTIONS		
-PFW04	Premium Wood Finish	44
-PX3(-)	Power Matrix 1 (one power, one USB-A, one USB-C)	514
-PX4(-)	Power Matrix 2 (dual power, one USB-A, one USB-C)	538
-NS04	Non-Skid Glides	29
-GC01 (ordered separately)	Ganging Connector	69

Note: For power matrix faceplate, please specify black (-B) or white (-W) finish.

ACHELLA MODULAR // DESIGNED BY CHRIS PANICHELLA

CONFIGURATION EXAMPLES:

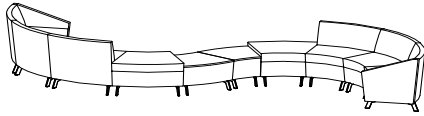

Qty	Model #	Description	COM List
2	1003.11.04.ALA	Lounge Chair, Left Arm, 30-Degree Inside Wedge (\$2,204 each)	\$4,408
4	1003.11.04.ANA	Lounge Chair, Armless, 30-Degree Inside Wedge (\$1,895 each)	\$7,580
2	1003.11.11	Bench, 30-Degree Wedge (\$1,711 each)	\$3,422
2	1003.20.16	Table, 30-Degree Wide (\$2,106 each)	\$4,212
<u>10</u>			<u>\$19,622</u>

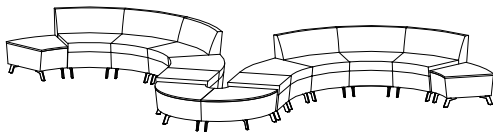

Qty	Model #	Description	COM List
2	1003.20.16	Table, 30-Degree Wide (\$2,106 each)	\$4,212
8	1003.11.04.ANA	Lounge Chair, Armless, 30-Degree Inside Wedge (\$1,895 each)	\$15,160
2	1003.11.11	Bench, 30-Degree Wedge (\$1,711 each)	\$3,422
2	1003.11.10	Bench, Straight (\$1,509 each)	\$3,018
2	1003.20.17	Table, 90-Degree (\$2,299 each)	\$4,598
<u>16</u>			<u>\$30,410</u>

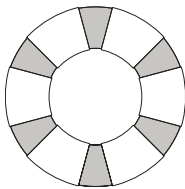

Qty	Model #	Description	COM List
6	1003.11.11	Bench, 30-Degree Wedge (\$1,711 each)	\$10,266
6	1003.20.15	Table, 30-Degree Narrow (\$1,776 each)	\$10,656
<u>12</u>			<u>\$20,922</u>

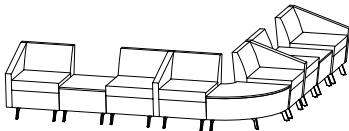

Qty	Model #	Description	COM List
3	1003.11.06.ARA	Lounge Chair, Right Arm, Straight (\$2,123 each)	\$6,369
2	1003.20.14	Table, 22" Straight (\$1,850 each)	\$3,700
2	1003.06.ANA	Lounge Chair, Armless, Straight (\$1,814 each)	\$3,628
1	1003.20.17	Table, 90-Degree, Outside Wedge	\$2,299
1	1003.11.06.ALA	Lounge Chair, Left Arm, Straight	\$2,123
<u>9</u>			<u>\$18,119</u>

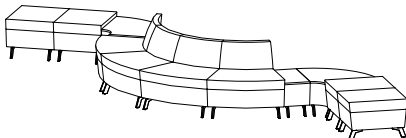

Qty	Model #	Description	COM List
4	1003.11.10	Bench, Straight (\$1,509 each)	\$6,036
2	1003.11.12	Bench, 90-Degree (\$2,117 each)	\$4,234
2	1003.20.13	Table, 12" Straight (\$1,521 each)	\$3,042
4	1003.11.05.ANA	Lounge Chair, Armless, 30-Degree Outside Wedge (\$1,969 each)	\$7,876
<u>12</u>			<u>\$21,188</u>

Note: Achella ganging connectors not included in pricing examples as shown above.

ACHELLA MODULAR // DESIGNED BY CHRIS PANICHELLA

UPHOLSTERY COMBINATIONS:

- » When combining two COM/COV/COL fabrics, or fabrics with the same grade, add \$120 List per unit.
- » When combining three COM/COV/COL fabrics, or fabrics with the same grade, add \$150 List per unit.
- » When combining different grades of fabric, price will be based on the highest grade specified.
- » Two-tone upholstery examples and yardage requirements for the most common combinations are listed below. Additional combinations available, please contact client services for yardage requirements and pricing.
- » Note: Yardage amounts are based on fabric which is plain (i.e. non-directional) and a full 54" wide.
- » Appropriate upholstery code must be included.



Code AM1

Model COM Requirement
2751 Seat Cushion Only = 1¹/₄ yds.
Balance of Chair = 2¹/₂ yds.



Code AM2

Model COM Requirement
2752 Seat Cushion Only = 1¹/₄ yds.
2753 Balance of Chair = 3¹/₂ yds.

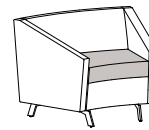

Code AM3

Model COM Requirement
2754 Seat Cushion Only = 1¹/₄ yds.
Balance of Chair = 4¹/₂ yds.



Code AM4

Model COM Requirement
2761 Seat Cushion Only = 1³/₄ yds.
Balance of Chair = 2 yds.

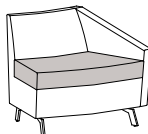

Code AM5

Model COM Requirement
2762 Seat Cushion Only = 1¹/₄ yds.
2763 Balance of Chair = 3 yds.

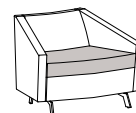

Code AM6

Model COM Requirement
2764 Seat Cushion Only = 1¹/₄ yds.
Balance of Chair = 4 yds.



Code AM7

Model COM Requirement
2771 Seat Cushion Only = 1 yd.
Balance of Chair = 1³/₄ yds.

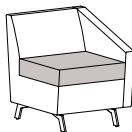

Code AM8

Model COM Requirement
2772 Seat Cushion Only = 1 yd.
2773 Balance of Chair = 2³/₄ yds.

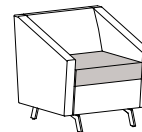

Code AM9

Model COM Requirement
2774 Seat Cushion Only = 1 yd.
Balance of Chair = 3³/₄ yds.



Code AM10

Model COM Requirement
2751 Inside Back/ Seat Cushion = 1¹/₂ yds.
Balance of Chair = 2 yds.

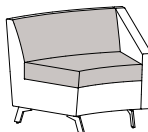

Code AM11

Model COM Requirement
2752 Inside Back/ Seat Cushion = 1¹/₂ yds.
2753 Balance of Chair = 3 yds.

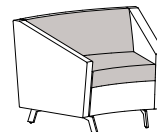

Code AM12

Model COM Requirement
2754 Inside Back/ Seat Cushion = 1¹/₂ yds.
Balance of Chair = 4¹/₄ yds.



Code AM13

Model COM Requirement
2761 Inside Back/ Seat Cushion = 1³/₄ yds.
Balance of Chair = 1³/₄ yds.

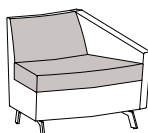

Code AM14

Model COM Requirement
2762 Inside Back/ Seat Cushion = 1³/₄ yds.
2763 Balance of Chair = 2³/₄ yds.

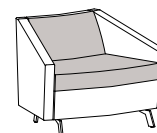

Code AM15

Model COM Requirement
2764 Inside Back/ Seat Cushion = 1³/₄ yds.
Balance of Chair = 3³/₄ yds.

ACHELLA MODULAR // DESIGNED BY CHRIS PANICHELLA

UPHOLSTERY COMBINATIONS:

- » When combining two COM/COV/COL fabrics, or fabrics with the same grade, add \$120 List per unit.
- » When combining three COM/COV/COL fabrics, or fabrics with the same grade, add \$150 List per unit.
- » When combining different grades of fabric, price will be based on the highest grade specified.
- » Two-tone upholstery examples and yardage requirements for the most common combinations are listed below. Additional combinations available, please contact client services for yardage requirements and pricing.
- » Note: Yardage amounts are based on fabric which is plain (i.e. non-directional) and a full 54" wide.
- » Appropriate upholstery code must be included.

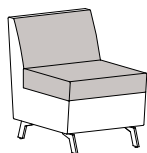

Code AM16
Model COM Requirement
 2771 Inside Back/ Seat Cushion = 1¹/₄ yds.
 Balance of Chair = 1³/₄ yds.

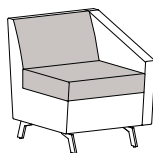

Code AM17
Model COM Requirement
 2772 Inside Back/Seat Cushion = 1¹/₄ yds.
 2773 Balance of Chair = 2³/₄ yds.

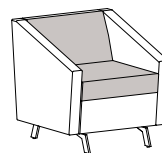

Code AM18
Model COM Requirement
 2774 Inside Back/Seat Cushion = 1¹/₄ yds.
 Balance of Chair = 3³/₄ yds.

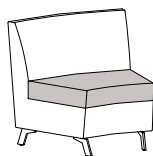

Code AH1
Model COM Requirement
 2751-H Seat Cushion Only = 1¹/₄ yds.
 Balance of Chair = 3 yds.

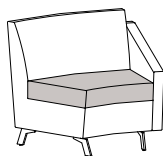

Code AH2
Model COM Requirement
 2752-H Seat Cushion Only = 1¹/₄ yds.
 2753-H Balance of Chair = 3³/₄ yds.

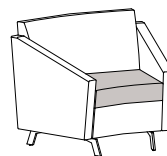

Code AH3
Model COM Requirement
 2754-H Seat Cushion Only = 1¹/₄ yds.
 Balance of Chair = 4¹/₄ yds.

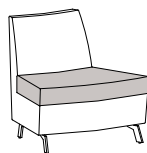

Code AH4
Model COM Requirement
 2761-H Seat Cushion Only = 1¹/₄ yds.
 Balance of Chair = 2³/₄ yds.



Code AH5
Model COM Requirement
 2762-H Seat Cushion Only = 1¹/₄ yds.
 2763-H Balance of Chair = 3¹/₄ yds.

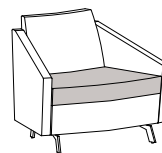

Code AH6
Model COM Requirement
 2764-H Seat Cushion Only = 1¹/₄ yds.
 Balance of Chair = 4¹/₄ yds.



Code AH7
Model COM Requirement
 2771-H Seat Cushion Only = 1 yd.
 Balance of Chair = 2 yds.



Code AH8
Model COM Requirement
 2772-H Seat Cushion Only = 1 yd.
 2773-H Balance of Chair = 3¹/₄ yds.

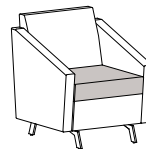

Code AH9
Model COM Requirement
 2774-H Seat Cushion Only = 1 yd.
 Balance of Chair = 4¹/₄ yds.

ACHELLA MODULAR // DESIGNED BY CHRIS PANICHELLA

UPHOLSTERY COMBINATIONS:

- » When combining two COM/COV/COL fabrics, or fabrics with the same grade, add \$120 List per unit.
- » When combining three COM/COV/COL fabrics, or fabrics with the same grade, add \$150 List per unit.
- » When combining different grades of fabric, price will be based on the highest grade specified.
- » Two-tone upholstery examples and yardage requirements for the most common combinations are listed below. Additional combinations available, please contact client services for yardage requirements and pricing.
- » Note: Yardage amounts are based on fabric which is plain (i.e. non-directional) and a full 54" wide.
- » Appropriate upholstery code must be included.

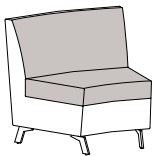

Code AH10
Model COM Requirement
 2751-H Inside Back/Seat Cushion = 1³/₄ yds.
 Balance of Chair = 2¹/₄ yds.

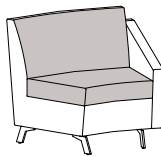

Code AH11
Model COM Requirement
 2752-H Inside Back/Seat Cushion = 1³/₄ yds.
 2753-H Balance of Chair = 3¹/₄ yds.

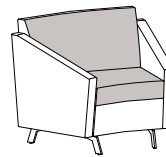

Code AH12
Model COM Requirement
 2754-H Inside Back/Seat Cushion = 1³/₄ yds.
 Balance of Chair = 4¹/₄ yds.



Code AH13
Model COM Requirement
 2761-H Inside Back/Seat Cushion = 1³/₄ yds.
 Balance of Chair = 2¹/₄ yds.

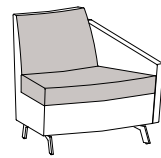

Code AH14
Model COM Requirement
 2762-H Inside Back/Seat Cushion = 1³/₄ yds.
 Balance of Chair = 3¹/₄ yds.

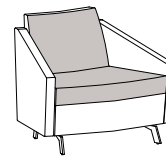

Code AH15
Model COM Requirement
 2764-H Inside Back/Seat Cushion = 1³/₄ yds.
 Balance of Chair = 4¹/₄ yds.



Code AH16
Model COM Requirement
 2771-H Inside Back/Seat Cushion = 1¹/₄ yds.
 Balance of Chair = 2 yds.

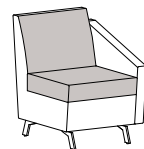

Code AH17
Model COM Requirement
 2772 Inside Back/Seat Cushion = 1¹/₄ yds.
 2773 Balance of Chair = 3³/₄ yds.

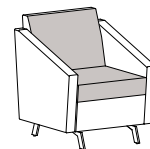

Code AH18
Model COM Requirement
 2774-H Inside Back/Seat Cushion = 1¹/₄ yds.
 Balance of Chair = 3³/₄ yds.

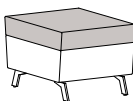

Code AM19
Model COM Requirement
 2780 Top of Seat = 1 yd.
 Balance of Seat = 1 yd.

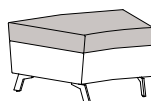

Code AM20
Model COM Requirement
 2785 Top of Seat = 1¹/₂ yds.
 Balance of Seat = 1¹/₄ yds.

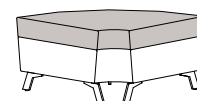

Code AM21
Model COM Requirement
 2786 Top of Seat = 1³/₄ yds.
 Balance of Seat = 1¹/₄ yds.

ACHELLA TABLES



arcadia

MARCH 1, 2026
VA IDIQ CONTRACT (FY26)
(DEALER HELD)

ACHELLA OCCASIONAL TABLES // DESIGNED BY CHRIS PANICHELLA



PRODUCT FEATURES/SPECIFICATIONS:

- » Tables manufactured in maple.
- » Custom sizes available, contact client services for pricing.
- » All tables feature veneer tops as standard. Laminate and Corian tops available.
- » For custom laminates, add \$642 List per color per order. Pre-approval required, please contact client services.
- » For Corian top, specify “-CO” next to model number. Corian top is affixed to table top surface increasing overall table height by 1/2". Please note that a 1/8" reveal will be present. For non-standard colors, please contact client services for pricing.
- » **Table with laminate or Corian top, finish selection for table body must be specified.**
- » All standard wood finishes available on maple.
- » For Super Matte Sable Maple, premium wood finish upcharge applies. Refer to options section for pricing.
- » For custom wood finishes, please add one-time upcharge of \$514 List per color per order.
- » 5" high cast aluminum leg available in three finishes.
- » All dimensions are nominal.

CORIAN® COLORS:

- » CWN Designer White
- » CLN Linen
- » CTD Witch Hazel
- » CRC Rain Cloud
- » CGQ Grey Onyx
- » CSQ Stonique

METAL LEG FINISHES:

- » 0299 Polished Aluminum
- » 0535 Metallic Silver
- » 0630 Satin Black

ACHELLA OCCASIONAL TABLES // DESIGNED BY CHRIS PANICHELLA

POWER UNITS:

- » Placement will be in the center of tops, unless otherwise specified.
- » Black or white finish with 120" electrical cord (no hardwire option available for this series).
- » UL listed.



PX3
5⁷/₈" W x 2⁷/₈" D
One outlet, one USB-A and one USB-C charging port

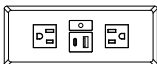

PX4
7¹/₄" W x 2⁷/₈" D
Two outlets, one USB-A and one USB-C charging port

ORDERING REQUIREMENTS:



- » Model number
- » Top finish
- » Body finish, as applicable
- » Metal leg finish
- » Options, as applicable

ACHELLA OCCASIONAL TABLES // DESIGNED BY CHRIS PANICHELLA

ORDERING REQUIREMENTS:

- » Model number
- » Metal leg finish
- » Top finish
- » Options, as applicable
- » Body finish, as applicable

Note: Table with laminate or Corian top, finish selection for table body must be specified.

		MODEL NUMBER	VENEER OR LAMINATE	CORIAN (-CO)	WEIGHT (Veneer/Laminate Top)
320	Achella Square/Rectangle Table				
	18" W x 18" L x 18" H	320-181818	1906	2312	53
	22" W x 22" L x 20" H	320-222220	2075	2699	87
	30" W x 30" L x 18" H	320-303018	2473	3660	107
	36" W x 36" L x 18" H	320-363618	2857	5066	115
325	Achella Round Table				
	18" Dia. x 18" H	325-1818	1956	2343	40
	22" Dia. x 20" H	325-2220	2251	2852	46
	30" Dia. x 18" H	325-3018	2665	3824	53
	36" Dia. x 18" H	325-3618	3225	5395	60
	42" Dia. x 18" H	325-4218	3653	6656	72

OPTIONS

-PFW04	Premium Wood Finish	44
-PX3-()	Power Matrix 3 (one power, one USB-A, one USB-C)	514
-PX4-()	Power Matrix 4 (dual power, one USB-A, one USB-C)	538

Note: For power matrix faceplate, please specify black (-B) or white (-W) finish.

ARCHETYPE TABLES



arcadia

MARCH 1, 2026
VA IDIQ CONTRACT (FY26)
(DEALER HELD)

ARCHETYPE OCCASIONAL TABLES // DESIGNED BY QDESIGN



PRODUCT FEATURES/SPECIFICATIONS:

- » Square tables offered in 36" and 42" sizes.
- » Open interior for storage or accessory display.
- » Tables available in walnut or white oak veneer and laminate, in all standard and custom finishes.
- » For Alabaster and Super Matte Sable Oak, premium wood finish upcharge applies. Refer to options section for pricing.
- » For custom wood finishes, please add one-time upcharge of \$514 List per color per order.
- » For custom laminates, add \$642 List per color per order. Pre-approval required, please contact client services.
- » Tops available in single-tone and split finish options.
- » For split tops, two different finishes within the same material can be selected (cannot combine veneer with laminate). Specify as primary and secondary top panels together with inset body finish. Bottom of the table will match primary top finish as standard, unless otherwise specified.
- » For veneer tops/bottoms, wood edge finish will match corresponding top finish color, unless otherwise specified.
- » For laminate tops/bottoms, self edge is standard, unless otherwise specified (laminate applied to edge).
- » Inset body for both top selections (single-tone and split) can be specified with a different material (e.g. veneer top/bottom with a laminate body). Please specify accordingly and add upcharge of \$220 per unit.
- » For additional finish combinations, contact client services.
- » Tables feature low-profile black feet with adjustable glides as standard.
- » All dimensions are nominal.

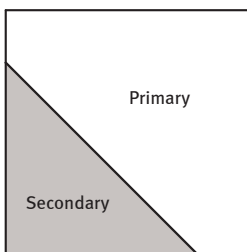

SPLIT TOP

ARCHETYPE OCCASIONAL TABLES // DESIGNED BY QDESIGN

POWER UNITS:

- » Unit will be centered vertically and horizontally on front inset as standard. For custom placement, please contact client services and add \$100 upcharge per location.
- » Black or white finish with 120" electrical cord (no hardwire option available for this series).
- » UL listed.

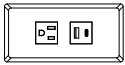

PX3
5⁷/₈" W x 2⁷/₈" D
One outlet, one USB-A and one USB-C charging port



PX4
7¹/₄" W x 2⁷/₈" D
Two outlets, one USB-A and one USB-C charging port

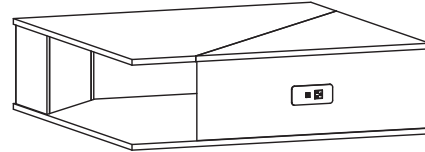

ORDERING REQUIREMENTS:

- » Model number
- » Top/bottom finish
- » Body finish
- » Options, as applicable

ARCHETYPE OCCASIONAL TABLES // DESIGNED BY QDESIGN

ORDERING REQUIREMENTS:

- » Model number
- » Top/bottom finish
- » Inset body finish
- » Options, as applicable

SINGLE-TONE TOP FINISH	MODEL NUMBER	VENEER OR LAMINATE	WEIGHT
4830 	Square Table 36" W x 36" D x 13" H 42" W x 42" D x 13" H	4142 4250	52 63

OPTIONS

-PFW04	Premium Wood Finish	44
-MM01	Mixed Materials (veneer/laminate)	220
-NS04	Non-Skid Glides	29
-PX3-()	Power Matrix 3 (one power, one USB-A, one USB-C)	514
-PX4-()	Power Matrix 4 (dual power, one USB-A, one USB-C)	538

Note: for power matrix faceplate, please specify black (-B) or white (-W) finish.

ARCHETYPE OCCASIONAL TABLES // DESIGNED BY QDESIGN

ORDERING REQUIREMENTS:

- » Model number
- » Primary top/bottom finish
- » Secondary top finish
- » Inset body finish
- » Options, as applicable

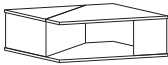
SPLIT TOP FINISH	MODEL NUMBER	VENEER OR LAMINATE	WEIGHT
4840 	Square Table 36" W x 36" D x 13" H 42" W x 42" D x 13" H	5198 5306	52 63
	4840-363613 4840-424213		

OPTIONS

-PFW04	Premium Wood Finish	44
-MM01	Mixed Materials (veneer/laminate)	220
-NS04	Non-Skid Glides	29
-PX3-()	Power Matrix 3 (one power, one USB-A, one USB-C)	514
-PX4-()	Power Matrix 4 (dual power, one USB-A, one USB-C)	538

Note: for power matrix faceplate, please specify black (-B) or white (-W) finish.

FLIPSIDE SEATING



arcadia

MARCH 1, 2026
VA IDIQ CONTRACT (FY26)
(DEALER HELD)

FLIPSIDE MODULAR BENCHES // DESIGNED BY GEMMA BERNAL



PRODUCT FEATURES:

- » Two, three and four-unit combinations for stand-alone and modular configurations.
- » Units are built as modules starting with the frame size, then adding seats and tables from left-to-right as facing.
- » Seating units offered with or without backrest and are available in two styles:



- Outside back accent offered in white oak veneer, laminate or Fenix, with solid wood accent on seat/backrest ends.
- Fully upholstered.
- » Accents on seat/backrest ends will always match outside back accent as standard.
- » Passive-flex backrest and suspension webbing in seat cushions provide continuous comfort.
- » Metal frame/leg available in standard and premium metal finishes.
- » Rear legs feature anti-tip device for added stability therefore, benches will always be directional.
- » Standard with black glides.
- » Backrest attachment will match metal frame finish as standard, unless specified otherwise.
- » Four-unit spans include center base.
- » Layout or drawing must be included for modular configurations.
- » Maximum weight capacity is 350 lbs. per seat.
- » Tamper-resistant floor mount hardware available.
- » All dimensions are nominal.



Anti-Tip Device

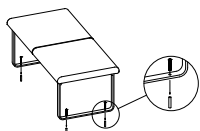

Floor Mount (FM01) - Concrete Application

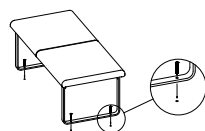

Floor Mount (FM02) - Wood Application

FLIPSIDE MODULAR BENCHES // DESIGNED BY GEMMA BERNAL

OPTIONAL CLEAN-OUT:

- » Fully upholstered seat cushions available with optional clean-out feature at no charge for maintenance ease.
- » Cushion width will be $\frac{3}{4}$ " less wide than standard seat but overall frame dimensions will remain the same.
- » Clean-out not available when units are specified with arms.

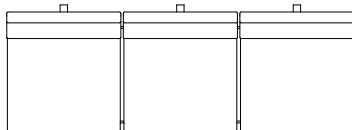

STANDARD METAL FRAME FINISHES:

- » 0405 Charcoal Grey
- » 0535 Metallic Silver
- » 0630 Satin Black

PREMIUM METAL FRAME FINISHES:

- » 0605 Matte Black
- » 0705 Matte Cotton
- » 0788 Glossy Cotton
- » 0805 Oasis
- » 0905 Mint
- » 1005 Mercury
- » 1105 Canary
- » 1205 Stone
- » 1305 Sage
- » 1405 Ice Blue
- » 1505 Clay

INTEGRATED TABLE (WITHIN MODULES), END AND CONNECTING TABLE SPECIFICATIONS:

- » 24" wide integrated table can be specified in any position.
- » 12" wide end table also available and is attached separately to the frame.
- » Connecting tables offered in corner, 12" wide and 24" wide models. These are ordered separately and require in-field installation.
- » End and connecting tables cannot gang next to another table.
- » All tables available in white oak veneer, laminate, Corian and Fenix.
- » 1" top thickness with bullnose edge at front and back of table.
- » All standard and custom wood finishes available.
- » For Alabaster and Super Matte Sable Oak, premium wood finish upcharge applies. Refer to options section for pricing.
- » For custom wood finishes, please add \$514 List per color per order.
- » For custom laminates, add \$642 List per color per order. Pre-approval required, please contact client services.
- » For laminate and Fenix specifications, please note that a $\frac{1}{16}$ " black reveal will be present in front and back.
- » For non-standard Fenix or Corian colors, please contact client services for pricing.

TABLE EDGE SPECIFICATIONS:

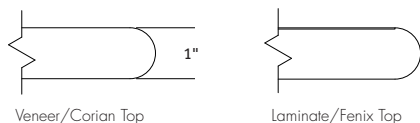

- » Table with veneer, standard wood grain laminate, solid white or solid black laminate, as well as Fenix Bianco Kos (white) and Fenix Nero Ingo (black), wood edge finish will match top finish color, unless otherwise specified.
- » For all other standard solid color laminates and Fenix options, wood edge finish must be specified.

FENIX® COLORS:

- » FJ0032 Bianco Kos
- » FJ0724 Grigio Bromo
- » FJ0725 Grigio Efeso
- » FJ0718 Grigio Londra
- » FJ0720 Nero Ingo

CORIAN® COLORS:

- » CWN Designer White
- » CLN Linen
- » CTD Witch Hazel
- » CRC Rain Cloud
- » CGQ Grey Onyx
- » CSQ Stonique

FLIPSIDE MODULAR BENCHES // DESIGNED BY GEMMA BERNAL

ARM FEATURES:

- » Available at seat ends, between seats as well as between a seat and table.
- » Ganging arm also available to connect two seating units together for continuous arm placement.
- » Metal arm with $\frac{3}{16}$ " thick Corian arm caps.
- » Arm to match metal bench frame finish as standard, unless otherwise specified.
- » Arms do not allow for clean-out option between fully upholstered seat cushions.
- » Arms ordered separately, with accompanying drawing or sketch required.
- » Arms will be attached to bench models prior to shipping, with the exception of ganging arms.

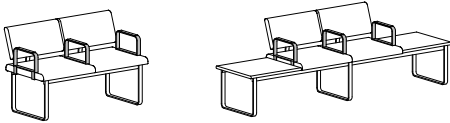

GANGING BRACKET:

- » One bracket connects two units together.
- » Not applicable for table-to-table ganging connections.
- » Field assembly required.



POWER UNITS:

- » Select models available for placement between modules as well as surface mounted on tables.
- » For table placement, please note that due to the thin top profile, electrical units will be visible from below.
- » Refer to pages 6-7 for power unit options and standard placement locations.

ORDERING REQUIREMENTS

- » Model number
- » Wood accent finish, as applicable
- » Metal frame finish
- » Upholstery selection
- » Options, as applicable

FLIPSIDE MODULAR BENCHES // DESIGNED BY GEMMA BERNAL

ORDERING INSTRUCTIONS

STEP 1: Select bench frame size as starting model number.



STEP 2: Build configuration with modules on next page, from left-to-right as facing. Cannot combine wood accent and fully upholstered seating models together on one frame.

24" wide integrated table can be specified in any position.

Refer to page 8 for ordering examples.

Ganging bracket connects two units together and is ordered separately. For end and connecting tables, refer to page 5.

Include layout drawing for modular configurations.

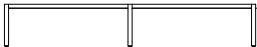
MODEL NUMBER	PRODUCT SPECIFICATIONS	LIST
7602-()-() 	Two-Unit Frame W 48 D 24 Seated Height 18 35 lbs.	973
7603-()-()-() 	Three-Unit Frame W 72 D 24 Seated Height 18 44 lbs.	1148
7604-()-()-()-() 	Four-Unit Frame (includes center base) Seated Height 18 W 96 D 24 61 lbs.	1444

OPTIONS		
-PFM03	Premium Metal Finish (Two and Three-Unit Frames)	152
-PFM05	Premium Metal Finish (Four-Unit Frame)	221
-NS06	Non-Skid Glides	41
-FM01	Tamper-Resistant Concrete Floor Mount	275
-FM02	Tamper-Resistant Wood Floor Mount	275
GC11	Ganging Bracket (ordered separately)	102

FLIPSIDE MODULAR BENCHES // DESIGNED BY GEMMA BERNAL

ORDERING INSTRUCTIONS

STEP 1: Select bench frame size as starting model number.



7602-(-)-(-)
Two-Unit Frame





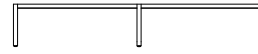

7603-(-)-(-)-(-)
Three-Unit Frame

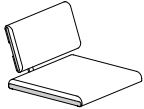
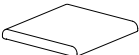

7604-(-)-(-)-(-)-(-)
Four-Unit Frame

STEP 2: Build configuration with options below, from left-to-right as facing. Cannot combine wood accent and fully upholstered seating models together on one frame. 24" wide tables can be specified in any position.

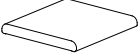
Refer to page 6 for connecting table and arm options, and page 9 for ordering examples.

MODEL NUMBER	PRODUCT SPECIFICATIONS	FABRIC GRADES										LEATHER		
		COM	A	1	2	3	4	5	6	7	8	L1	L2	
-SW 	Seat Only, Wood Accent W 24 D 24 1 yd. 8 lbs. COL 20 sq. ft.	637	702	734	754	786	821	854	887	918	955	1106	1221	
-BW 	Seat with Backrest, Wood or Laminate* Accent W 24 D 25 ³ / ₄ 1 ³ / ₄ yds. 17 lbs. COL 35 sq. ft.	Wood/Laminate	1167	1281	1337	1372	1428	1489	1547	1605	1659	1724	1988	2189
		Fenix (-FE)	1257	1371	1427	1462	1518	1579	1637	1695	1749	1814	2078	2279
-SU 	Seat Only, Fully Upholstered W 24 D 24 1 yd. 8 lbs. COL 20 sq. ft.	568	633	665	685	717	752	785	818	849	886	1037	1152	
-BU 	Seat with Backrest, Fully Upholstered W 24 D 25 ³ / ₄ 1 ³ / ₄ yds. 17 lbs. COL 35 sq. ft.	1021	1135	1191	1226	1282	1343	1401	1459	1513	1578	1842	2043	
-SUV 	Seat Only, Fully Upholstered with Clean-Out W 23 ¹ / ₄ D 24 1 yd. 8 lbs. COL 20 sq. ft.	568	633	665	685	717	752	785	818	849	886	1037	1152	
-BUV 	Seat with Backrest, Fully Upholstered with Clean-Out W 23 ¹ / ₄ D 25 ³ / ₄ 1 ³ / ₄ yds. 17 lbs. COL 35 sq. ft.	1021	1135	1191	1226	1282	1343	1401	1459	1513	1578	1842	2043	

INTEGRATED TABLE

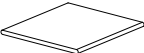
MODEL NUMBER	PRODUCT SPECIFICATIONS	TABLE TOP FINISH		
		VENEER OR LAMINATE	FENIX (-FE)	CORIAN (-CO)
-24T 	24" Wide Integrated Table W 24 D 24 14 lbs.	796	886	1144

OPTIONS

-PFW01	Premium Wood Finish, Wood Accent	12
-PFW04	Premium Wood Finish, Tables	44
-MB01	Moisture Barrier (seat only), per seat	69



*Please note that laminate only applies to outside back. Seat/backrest ends are solid wood and will match outside back as standard.

FLIPSIDE MODULAR BENCHES // DESIGNED BY GEMMA BERNAL

ORDERING REQUIREMENTS:

- » End and connecting tables ordered separately and cannot be ganged next to another table.
- » Specify table top finish.

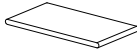
Field-installation required. Please provide layout drawings for modular configurations.

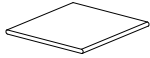
MODEL NUMBER	PRODUCT SPECIFICATIONS	TABLE TOP FINISH		
		VENEER OR LAMINATE	FENIX (-FE)	CORIAN (-CO)
END & CONNECTING TABLES - HARDWARE INCLUDED				
7609	12" Wide End Table W 12 D 24 12 lbs.	723	768	980
				
7610	Corner Connecting Table W 41 ³ / ₄ D 24 ¹ / ₂ 19 lbs.	909	1089	1605
				
7612	12" Wide Connecting Table W 12 D 24 12 lbs.	636	681	810
				
7624	24" Wide Connecting Table W 24 D 24 18 lbs.	806	896	1154
				
OPTIONS				
-PFW04	Table Premium Wood Finish	44		

ARMS - CORIAN ARM CAPS

- » Arm finish will match frame finish as standard. Corian arm cap color must be specified.
- » Please note arms cannot be specified with clean-out seat options.
- » Order quantity of arms required with layout drawing included.

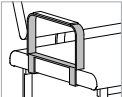
MODEL NUMBER	PRODUCT SPECIFICATIONS	LIST
7650	Individual Arm with Corian Arm Cap For placement at the end of a seat, between seats, between seat and table, as well as to gang seating units together (for continuous arm placement)	426
		

FLIPSIDE MODULAR BENCHES // DESIGNED BY GEMMA BERNAL

POWER UNITS:

- » Specify power unit model number after applicable bench configuration model number.
- » Frame-mounted units are attached below the metal frame and cannot be affixed where a base is positioned.
- » For table placement, please note that due to the thin top profile, electrical units will be visible from below.

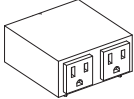
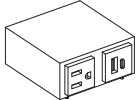
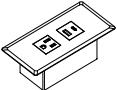
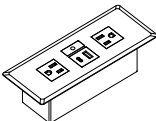
MODEL NUMBER	PRODUCT SPECIFICATIONS	LIST
FRAME MOUNTED		
USB3-B (BLACK FINISH) 	USB Charging Dock 3 <ul style="list-style-type: none"> » Dimensions: 2¹/₂" W x 1¹/₂" D x 3³/₄" H » Black finish » One (1) USB-A and one (1) USB-C charging ports with blue LED back lighting » 96" electrical cord (only length available) » UL listed 	179
MT2-B (BLACK FINISH) MT2-W (WHITE FINISH) 	Mini-Tap 2 <ul style="list-style-type: none"> » Dimensions: 3" W x 3" D x 1³/₄" H » Black or white finish » Two (2) simplex outlets » 72" electrical cord (only length available) 	367
MT3-B (BLACK FINISH) MT3-W (WHITE FINISH) 	Mini-Tap 3 <ul style="list-style-type: none"> » Dimensions: 3" W x 3" D x 1³/₄" H » Black or white finish » One (1) simplex outlet, one (1) USB-A and one (1) USB-C charging port » 72" electrical cord (only length available) » UL listed 	399
MODEL NUMBER	PRODUCT SPECIFICATIONS	LIST
TABLE MOUNTED		
PX3-B (BLACK FINISH) PX3-W (WHITE FINISH) 	Power Matrix 3 <ul style="list-style-type: none"> » Dimensions: 5⁷/₈" W x 2⁷/₈" D » Black or white finish » One (1) outlet, one (1) USB-A and one (1) USB-C charging port » 120" electrical cord (only length available) » UL listed 	514
PX4-B (BLACK FINISH) PX4-W (WHITE FINISH) 	Power Matrix 4 <ul style="list-style-type: none"> » Dimensions: 7¹/₄" W x 2⁷/₈" D » Black or white finish » Two (2) outlets, one (1) USB-A and one (1) USB-C charging port » 120" electrical cord (only length available) » UL listed 	538

FLIPSIDE MODULAR BENCHES // DESIGNED BY GEMMA BERNAL

POWER UNIT STANDARD PLACEMENT (PRE-INSTALLED TO THE FRAME):

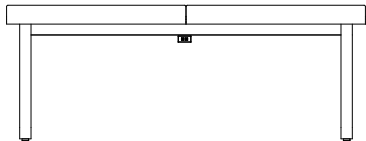

TWO-UNIT BENCHES: Center placement as standard.



THREE-UNIT BENCHES:
One Power Unit - Please specify location.
Two Power Units - Placement between modules.

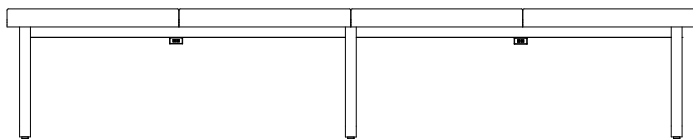

FOUR-UNIT BENCHES:
One Power Unit - Please specify location.
Two Power Units - Centered between bases.

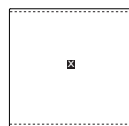

ALL TABLES: Center placement as standard.

For specific placement requirements, please contact client services for assistance.

Power units also available separately for placement anywhere along the bench frame (with the exception of where legs are positioned). Installation required. Please specify and power unit, together with mounting hardware, will ship independent of the bench.

FLIPSIDE MODULAR BENCHES // DESIGNED BY GEMMA BERNAL

CONFIGURATION EXAMPLES:

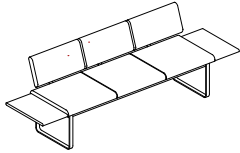

Model #
7603-BW-BW-BW

7609

Description (Left-to-Right as Facing)
Three-Unit Bench
Seats with Backrest and Wood Accents, qty. 3 (\$1,167 each)
12" End Tables, qty. 2 (\$723 each)

COM List
\$1,148
\$3,501
\$1,446
\$6,095

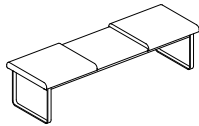

Model #
7603-SU-24T-SU

Description (Left-to-Right as Facing)
Three-Unit Bench
Seat Only, Fully Upholstered
24" Integrated Table
Seat Only, Fully Upholstered

COM List
\$1,148
\$568
\$796
\$568
\$3,080

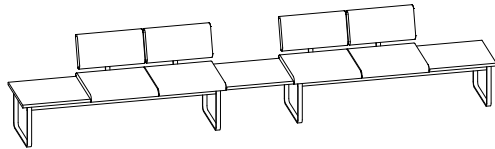

Model #
7603-24T-BW-BW

7624
7603-BW-BW-24T

Description (Left-to-Right as Facing)
Three-Unit Bench: 24" Integrated Table,
Seat with Backrest x 2, Wood Accents
24" Connecting Table
Three-Unit: Seat with Backrest x 2,
24" Table, Wood Accents

COM List
\$4,278
\$806
\$4,278
\$9,362

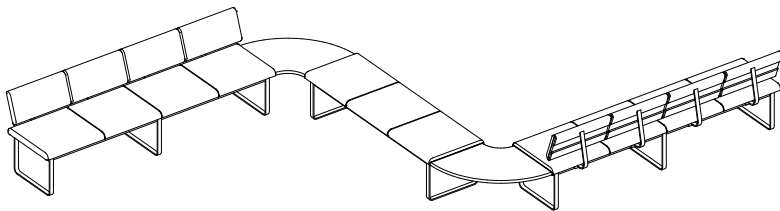

<u>Qty</u>	<u>Model #</u>	<u>Description (Left-to-Right as Facing)</u>	<u>COM List</u>
2	7604-BW-BW-BW-BW	Four Unit Bench: Seats with Backrest and Wood Accents (\$6,112 each)	\$12,224
1	7603-SW-SW-SW	Three Unit Bench: Seats Only with Wood Accents	\$3,059
2	7610	Corner Table (\$909 each)	<u>\$1,818</u>
5			\$17,101

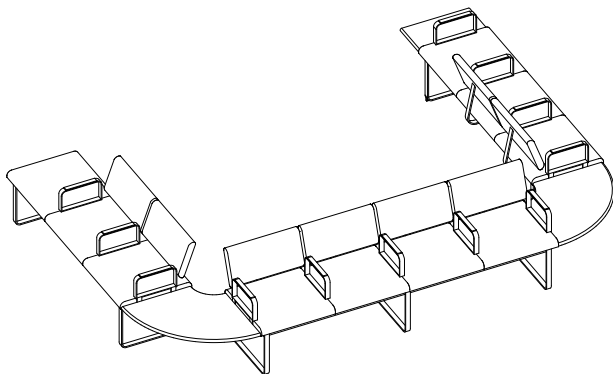

<u>Qty</u>	<u>Model #</u>	<u>Description (Left-to-Right as Facing)</u>	<u>COM List</u>
1	7603-SU-BU-BU	Three-Unit Bench: Seat Only, Seat w/Backrest, Seat w/Backrest, Fully Upholstered	\$3,758
2	7610	Corner Table (\$909 each)	\$1,818
1	7604-BU-BU-BU-BU	Four-Unit Bench: Seats with Backrest, Fully Upholstered	\$5,528
1	7603-BU-BU-SU	Three-Unit Bench: Seat w/Backrest, Seat w/Backrest, Seat Only	\$3,758
1	7609	12" Wide End Table	\$723
12	7650	Individual Arms (\$426 each)	<u>\$5,112</u>
18			\$20,697

FLIPSIDE MODULAR BENCHES // DESIGNED BY GEMMA BERNAL

UPHOLSTERY COMBINATIONS:

- » When combining two COM/COV/COL fabrics, or fabrics with the same grade, add \$120 List per unit.
- » When combining three COM/COV/COL fabrics, or fabrics with the same grade, add \$150 List per unit.
- » When combining different grades of fabric, price will be based on the highest grade specified.
- » Two-tone upholstery examples and yardage requirements for the most common combinations are listed below. Additional combinations available, please contact client services for yardage requirements and pricing.
- » Note: Yardage amounts are based on fabric which is plain (i.e. non-directional) and a full 54" wide.
- » Appropriate upholstery code must be included.

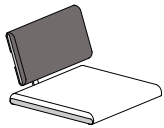

Code

Model

-BW
-BU
-BUV

FB1

COM Requirement

Back Cushion = $\frac{3}{4}$ yd.
Seat Cushion = 1 yd.

FLIRT SEATING



MARCH 1, 2026
VA IDIQ CONTRACT (FY26)
(DEALER HELD)

FLIRT® GUEST // DESIGNED BY 5D STUDIO



PRODUCT FEATURES:

- » 4-leg and swivel base models available.
- » 4-leg base available with chrome casters or on glides (chrome finish only).
- » Casters suitable for carpet or hard-surface floors.
- » Flip-up or fixed seat options.
- » Swivel base model features auto-return as standard. Fixed seat only.
- » Swivel base model not available with casters.
- » Optional contrasting stitch thread available in 12 colors. Please refer to listing on following page, add "-CS00" after model number and specify color.
- » Maximum weight capacity is 350 lbs.
- » All dimensions are nominal.

FLIP-UP ROTATING TABLET:

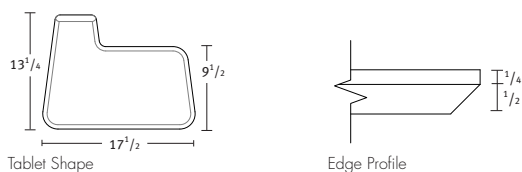

- » Tablet features flip-up capability in addition to 120-degree turning radius.
- » Nesting chairs with tablets maintain nesting capability.
- » Tablet dimensions: 17¹/₂" W x 13³/₄" D x 3³/₄" thick.

SPECIFICATIONS:

- » Metal base available in standard and premium finishes.
- » Tablet available in veneer and laminate surface options.
- » Veneer offered in maple, walnut and white oak, in all standard and custom wood finishes. Edge will always match the top finish color, unless otherwise specified.
- » Premium wood finish upcharge applies to the following wood finishes. Refer to options section for pricing.
 - Super Matte Sable Maple
 - Alabaster Oak
 - Super Matte Sable Oak

FLIRT® GUEST // DESIGNED BY 5D STUDIO

SPECIFICATIONS CONTINUED:

- » For custom wood finishes, please add one-time upcharge of \$514 List per color per order.
- » Laminate is applied to tablet top surface only.
- » For custom laminates, add \$642 List per color per order. Pre-approval required, please contact client services.
- » For standard wood grain and solid black laminates, edge finish will match the laminate top color, unless otherwise specified.
- » For all other standard solid color laminates, edge finish will be natural (clear coat) as standard, unless otherwise specified.
- » Tablet mounting bracket finish will be as follows:
 - For bases specified with 0535 Metallic Silver finish, tablet bracket will be 0535 Metallic Silver.
 - For bases specified with 0299 Polished Aluminum, tablet bracket will be 0299 Polished Aluminum.
 - For bases specified in 0405 Charcoal Grey or 0630 Satin Black, tablet bracket will be 0299 Polished Aluminum as standard. If matching finish is required, please specify and add \$137 to List Price per unit.
 - For bases specified in premium finish colors, tablet bracket will match as standard, unless otherwise specified.

STANDARD METAL BASE FINISHES:

- » 0299 Polished Aluminum
- » 0405 Charcoal Grey
- » 0535 Metallic Silver
- » 0630 Satin Black

PREMIUM METAL BASE FINISHES:

- » 0605 Matte Black
- » 0705 Matte Cotton
- » 0788 Glossy Cotton
- » 0805 Oasis
- » 0905 Mint
- » 1005 Mercury
- » 1105 Canary
- » 1205 Stone
- » 1305 Sage
- » 1405 Ice Blue
- » 1505 Clay

ORDERING REQUIREMENTS:

- » Model number
- » Metal base finish
- » Upholstery selection
- » Options, as applicable

CONTRASTING THREAD COLORS:



White



Black



Omni Gray
PMS Cool Gray 10 C



Pale Blue
PMS 278 C



Navy
PMS 534 C



Hunter
PMS 560 C



Seaglass
PMS 2234 C



String
PMS 2310 C



Goldfinch
PMS 122 C



Cardinal
PMS 200 C



Tinsel
PMS 7543 C



Citron
PMS 2404 C

While the images and PMS colors above are close representations, please note that the actual thread color may vary slightly.

FLIRT® GUEST // DESIGNED BY 5D STUDIO

NESTING DIMENSIONS:

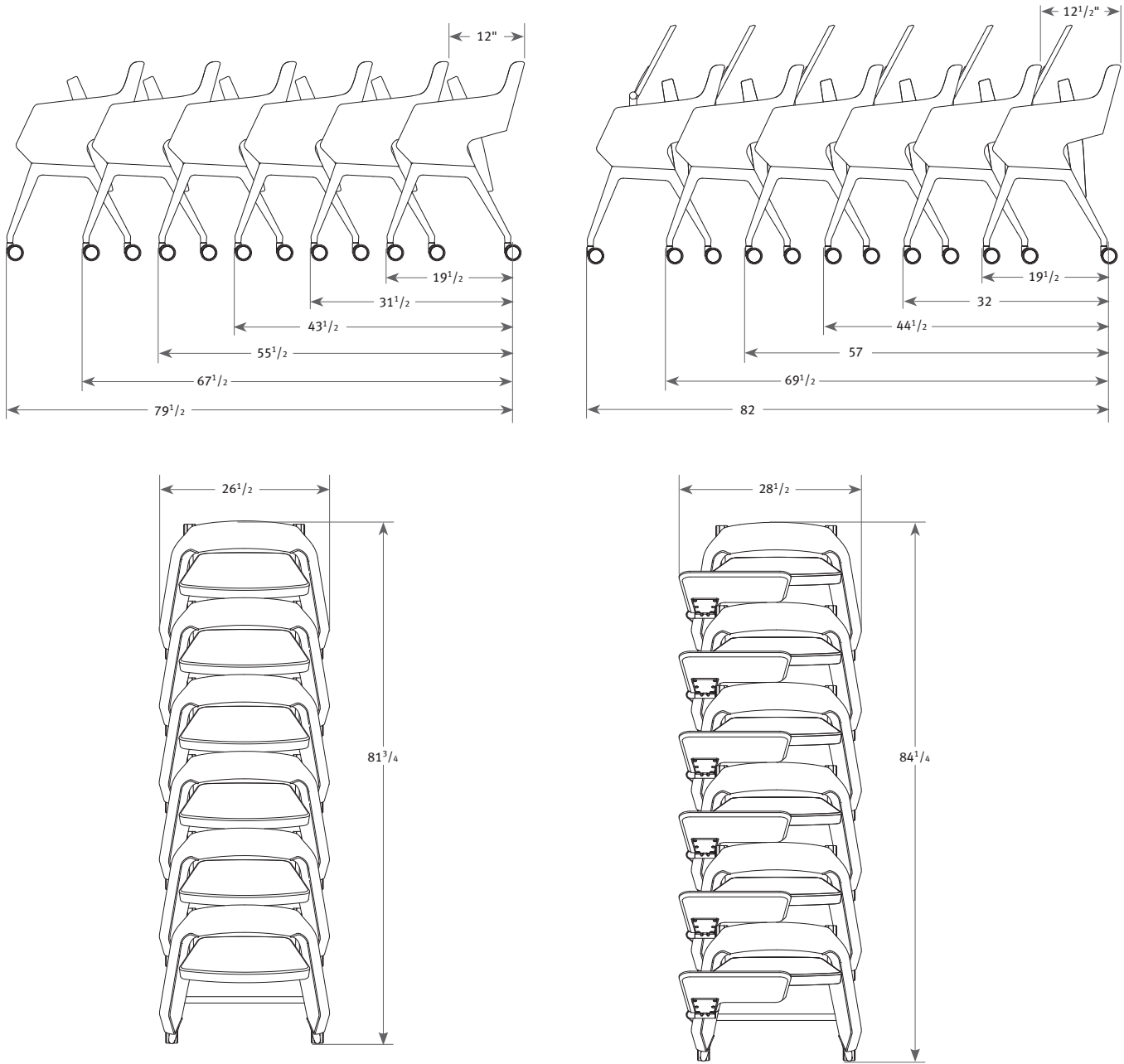



*Dimensions are nominal and based on the average distance between nested chairs.

FLIRT® GUEST // DESIGNED BY 5D STUDIO

ORDERING REQUIREMENTS:

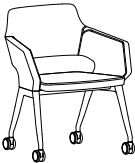
- » Model number
- » Metal base finish
- » Upholstery selection
- » Options, as applicable

MODEL NUMBER	PRODUCT SPECIFICATIONS	FABRIC GRADES										LEATHER			
		COM	A	1	2	COL		3	4	5	6	7	8	L1	L2
6910	 <p> 4-Leg Guest Chair, Flip-Up Seat, Casters W 27 D 24 H 31 Seat Height 18 Inside Seat Width 19 Inside Seat Depth 19 Arm Height 25 2¹/₄ yds. 34 lbs. COL 45 sq. ft. </p>	2113	2260	2332	2377	2449	2527	2602	2676	2746	2829	3169	3427		
6915	 <p> Swivel Base Guest Chair, Fixed Seat W 27 D 24 H 31 Seat Height 18 Inside Seat Width 19 Inside Seat Depth 19 Arm Height 25 2¹/₄ yds. 34 lbs. COL 45 sq. ft. </p>	2119	2266	2338	2383	2455	2533	2608	2682	2752	2835	3175	3433		

OPTIONS		
-FS01	Fixed Seat, 4-Leg Base Model Only	37
-GD00	Glides, 4-Leg Base (Chrome finish only)	n/c
-NS04	Non-Skid Glides, Swivel Base	29
-TAR06	Veneer/Laminate Rotating Tablet, Right (as seated)	616
-TAL06	Veneer/Laminate Rotating Tablet, Left (as seated)	616
-TBF01	Charcoal Grey and Satin Black Tablet Bracket	137
-PFM06	Premium Metal Finish, Base and Tablet Bracket	303
-PFW03	Premium Wood Finish, Rotating Tablet	34

☼ = Available on quick-ship program (polished aluminum or metallic silver base finish only).

FLIRT® GUEST // DESIGNED BY 5D STUDIO

UPHOLSTERY COMBINATIONS:

- » When combining two COM/COV/COL fabrics, or fabrics with the same grade, add \$120 List per unit.
- » When combining three COM/COV/COL fabrics, or fabrics with the same grade, add \$150 List per unit.
- » When combining different grades of fabric, price will be based on the highest grade specified.
- » Two-tone upholstery examples and yardage requirements for the most common combinations are listed below. Additional combinations available, please contact client services for yardage requirements and pricing.
- » Note: Yardage amounts are based on fabric which is plain (i.e. non-directional) and a full 54" wide.
- » Appropriate upholstery code must be included.



Code	FL1
<u>Models</u>	<u>COM Requirement</u>
6910	Back and Arm Panels = 1 ¹ / ₄ yds.
6915	Seat = 1 yd.

FLIRT TABLES



MARCH 1, 2026
VA IDIQ CONTRACT (FY26)
(DEALER HELD)

FLIRT® MEETING TABLES // DESIGNED BY 5D STUDIO



PRODUCT FEATURES:

- » Round and arc square top shapes.
- » 26", 29" and 42" table heights.
- » Custom heights between 26" - 42" available, please specify and add \$253 List upcharge per unit. Price is based on the higher standard table height (e.g. 32" custom height, price is based on the 42" standard height plus \$253).
- » Table column diameter: 2 $\frac{3}{4}$ ".
- » Base standard with adjustable glides and facilitates wire management for through-the-surface electrical and/or data capability.
- » Please note that Canadian shipments are unable to be shipped blanket-wrapped and a 10% cartoning surcharge will always apply.
- » All dimensions are nominal.

SPECIFICATIONS:

- » Five table surface options: veneer, laminate, Fenix, Corian or back-painted glass.
- » Veneer offered in maple, walnut and white oak wood species.
- » All standard and custom wood finishes available.
- » Premium wood finish upcharge applies to the following wood finishes. Refer to options section for pricing.
 - Super Matte Sable Maple
 - Alabaster Oak
 - Super Matte Sable Oak
- » For custom wood finishes, please add one-time upcharge of \$514 List per color per order.
- » Laminate tops available in all standard laminates.
- » For custom laminates, add \$642 List per color per order. Pre-approval required, please contact client services.
- » Unless specified, veneer and laminate wood grain direction will run lengthwise on all rectangle top sizes.
- » Fenix offered in five standard colorways.
- » Glass is back-painted white as standard and may be used as a writable surface with dry-erase markers.
- » For non-standard Fenix, Corian or back-painted glass colors, please contact client services for pricing.
- » Metal pedestal base manufactured in aluminum and offered in standard as well as premium finish selections.

EDGE FINISH SPECIFICATIONS:

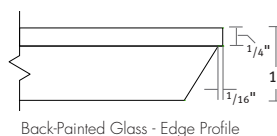
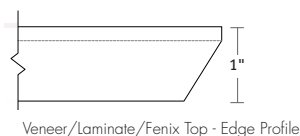

FLIRT® MEETING TABLES // DESIGNED BY 5D STUDIO

EDGE FINISH SPECIFICATIONS CONTINUED:

- » Beveled edge detail.
- » Table with veneer, standard wood grain or solid black laminate, and Fenix Nero Ingo (black), edge finish will match top finish color, unless otherwise specified.
- » For all other standard solid color laminates and Fenix options, as well as Corian and back-painted glass, edge will be natural exposed plywood with a clear coat finish as standard, unless otherwise specified.

FENIX® COLORS:

- » FJ0032 Bianco Kos
- » FJ0720 Nero Ingo
- » FJ0725 Grigio Efeso
- » FJ0718 Grigio Londra
- » FJ0724 Grigio Bromo

CORIAN® COLORS:

- » CWN Designer White
- » CLN Linen
- » CTD Witch Hazel
- » CRC Rain Cloud
- » CGQ Grey Onyx
- » CSQ Stonique

STANDARD METAL LEG FINISHES:

- » 0299 Polished Aluminum
- » 0405 Charcoal Grey
- » 0535 Metallic Silver
- » 0630 Satin Black

PREMIUM METAL LEG FINISHES:

- » 0605 Matte Black
- » 0705 Matte Cotton
- » 0788 Glossy Cotton
- » 0805 Oasis
- » 0905 Mint
- » 1005 Mercury
- » 1105 Canary
- » 1205 Stone
- » 1305 Sage
- » 1405 Ice Blue
- » 1505 Clay

POWER UNITS:

- » Available on all table sizes and heights.
- » Touch latch lid provides easy access to data and electrical features.
- » Metallic silver finish with 72" electrical cord (no hardwire option available for this series).
- » UL listed.

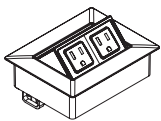

PP2
5¹/₄" W x 4¹/₄" L
Two outlets

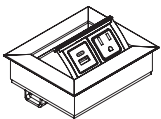

PP3
5¹/₄" W x 4¹/₄" L
One outlet, one USB-A and one USB-C charging port



ORDERING REQUIREMENTS:

- » Model number
- » Wood species, as applicable
- » Wood finish, as applicable
- » Metal base finish
- » Options, as applicable

FLIRT® MEETING TABLES // DESIGNED BY 5D STUDIO

ORDERING REQUIREMENTS:

- » Model number
- » Wood species, as applicable
- » Wood finish, as applicable
- » Metal base finish
- » Options, as applicable

		MODEL NUMBER	VENEER OR LAMINATE	FENIX (-FE)	CORIAN (-CO)	BACK-PAINTED GLASS (-PG)	WEIGHT <small>(Veneer/Lam/FE Top)</small>
 <p>Round Top, 26" Height</p> <p>29" Dia. x 26" H 36" Dia. x 26" H 42" Dia. x 26" H</p>		FX8-2926-BV	2213	2475	3541	2916	33
		FX8-3626-BV	2531	2935	4757	3299	43
		FX8-4226-BV	2992	3541	6036	3852	54
 <p>Round Top, 29" Height</p> <p>29" Dia. x 29" H 36" Dia. x 29" H 42" Dia. x 29" H</p>		FX8-2929-BV	2290	2552	3613	2989	34
		FX8-3629-BV	2607	3011	4827	3375	44
		FX8-4229-BV	3070	3619	6110	3925	55
 <p>Round Top, 42" Height</p> <p>29" Dia. x 42" H 36" Dia. x 42" H</p>		FX8-2942-BV	2533	2795	3852	3232	37
		FX8-3642-BV	2848	3252	5064	3618	47



OPTIONS		
-PFM03	Premium Metal Finish	152
-PFW04	Premium Wood Finish	44
-NS04	Non-Skid Glides	29
-PP2	Portal Power 2 (Dual Power)	730
-PP3	Portal Power 3 (1 Power, 2 USB)	862
-PC01	Glass Top Electrical Unit Cut-Out	87

☉ = Available on quick-ship program, all sizes and standard surface materials (polished aluminum or metallic silver base finishes only).

FLIRT® MEETING TABLES // DESIGNED BY 5D STUDIO

ORDERING REQUIREMENTS:

- » Model number
- » Wood species, as applicable
- » Wood finish, as applicable
- » Metal base finish
- » Options, as applicable

	MODEL NUMBER	VENEER OR LAMINATE	FENIX (-FE)	CORIAN (-CO)	BACK-PAINTED GLASS (-PG)	WEIGHT <small>(Veneer/Lam/FE Top)</small>
 <p>Arc-Square Top, 26" Height</p> <p>30" W x 30" L x 26" H 36" W x 36" L x 26" H 42" W x 42" L x 26" H</p>	FX9-303026-BV	2233	2513	3560	3136	33
	FX9-363626-BV	2550	2954	4777	3553	43
	FX9-424226-BV	3023	3572	6065	4151	54
 <p>Arc-Square Top, 29" Height</p> <p>30" W x 30" L x 29" H 36" W x 36" L x 29" H 42" W x 42" L x 29" H</p>	FX9-303029-BV	2309	2589	3632	3217	34
	FX9-363629-BV	2628	3032	4851	3635	44
	FX9-424229-BV	3096	3645	6138	4231	55
 <p>Arc-Square Top, 42" Height</p> <p>30" W x 30" L x 42" H 36" W x 36" L x 42" H</p>	FX9-303042-BV	2550	2830	3866	3480	37
	FX9-363642-BV	2871	3275	5088	3897	47

OPTIONS

-PFM03	Premium Metal Finish	152
-PFW04	Premium Wood Finish	44
-NS04	Non-Skid Glides	29
-PP2	Portal Power 2 (Dual Power)	730
-PP3	Portal Power 3 (1 Power, 2 USB)	862
-PC01	Glass Top Electrical Unit Cut-Out	87

 = Available on quick-ship program, all sizes and standard surface materials (polished aluminum or metallic silver base finishes only).

FLIRT® MULTI-PURPOSE MEETING TABLES // DESIGNED BY 5D STUDIO



TABLE TOP FEATURES/SPECIFICATIONS:

- » Fixed and flip-up tables available.
- » Flip-up tables feature a single-lever release mechanism for quick and easy set-up and storage.
- » Table tops offered in maple, walnut and white oak veneer, as well as laminate and Fenix selections.
- » All standard wood finishes, excluding MA0915 Ebony Maple, available on selected wood species.
- » Premium wood finish upcharge applies to the following wood finishes. Refer to options section for pricing.
 - Super Matte Sable Maple
 - Alabaster Oak
 - Super Matte Sable Oak
- » For custom wood finishes, please add one-time upcharge of \$514 List per color per order.
- » Laminate tops available in all standard laminates.
- » For custom laminates, add \$642 List per color per order. Pre-approval required, please contact client services.
- » Unless specified, wood grain direction will run lengthwise on all tables.
- » Fenix offered in five standard colorways.

FENIX COLORS:

- » FJ0032 Bianco Kos
- » FJ0720 Nero Ingo
- » FJ0725 Grigio Efeso
- » FJ0718 Grigio Londra
- » FJ0724 Grigio Bromo

TABLE EDGE FEATURES/SPECIFICATIONS:



- » All edges are 1" thick.
- » Eased and Beveled edge styles available on all tables.
- » Waterfall edge available in veneer or laminate finishes only (excludes Fenix). Offered on one or two sides, with Beveled edge featured on remaining sides.

FLIRT® MULTI-PURPOSE MEETING TABLES // DESIGNED BY 5D STUDIO

TABLE EDGE FEATURES/SPECIFICATIONS (CONTINUED):

- » Eased and Beveled edge finish will match veneer, standard wood grain or solid black laminate, and Fenix Nero Ingo (black) table top finish color, unless otherwise specified.
- » For all other standard solid color laminates and Fenix, Eased and Beveled edge will be natural exposed plywood with a clear coat finish, as standard.
- » For waterfall edge finish, laminate tops are post-formed to deliver a seamless finish from the top surface to the edge underside.

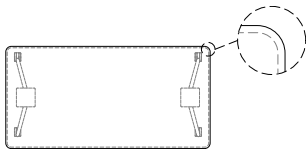

Beveled edge tables will have radiused corners

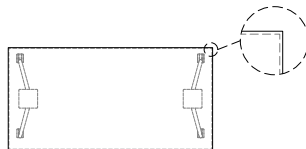

Eased edge tables will have 90-degree corners

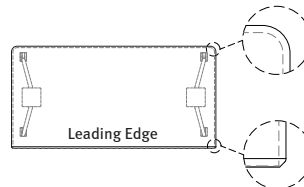

One-sided waterfall edge tables will have 90-degree corner on leading edge and radiused corner on opposing side

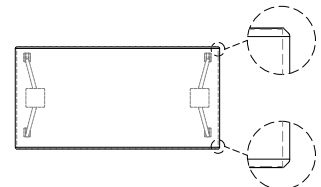

Two-sided waterfall edge tables will have 90-degree corners on all sides

BASE FEATURES/SPECIFICATIONS:

- » Die-cast aluminum legs available in standard and premium metal finishes.
- » Interior leg column features removable cover for vertical wire management.
- » Mobile version standard with 4 locking chrome casters that are suitable for carpet and hard-surface floors.
- » Glides presented in chrome finish and are non-adjustable.
- » Non-skid glides available for hard-surface floors.
- » Fixed top tables 78" in length and greater, as well as all 42" high tables, feature a stretcher bar for added stability. Stretcher bar will match leg finish as standard, unless otherwise specified.
- » Edge mount bases are positioned 3" from table edge for additional leg space.
- » Inset mount bases are positioned 15" from table edge to provide seating on all sides.

STANDARD METAL LEG FINISHES:

- » 0299 Polished Aluminum
- » 0405 Charcoal Grey
- » 0535 Metallic Silver
- » 0630 Satin Black

PREMIUM METAL LEG FINISHES:

- » 0605 Matte Black
- » 0705 Matte Cotton
- » 0788 Glossy Cotton
- » 0805 Oasis
- » 0905 Mint
- » 1005 Mercury
- » 1105 Canary
- » 1205 Stone
- » 1305 Sage
- » 1405 Ice Blue
- » 1505 Clay

CONNECTING TABLE MECHANISM FEATURES:

- » Ordered separately, ganging mechanism comes two per set to connect two tables together (end-to-end, side-to-side, end-to-side, etc.).
- » **Please include layout drawings or sketch with each order to ensure proper ganging bracket placement location.**

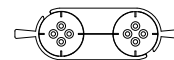
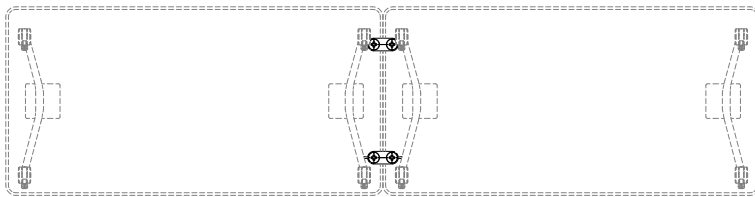

Ganging mechanism, locked
(2 units above are included per set).

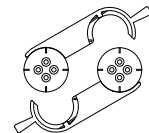

Ganging mechanism, unlocked.

FLIRT® MULTI-PURPOSE MEETING TABLES // DESIGNED BY 5D STUDIO

MODESTY PANEL PRODUCT FEATURES:

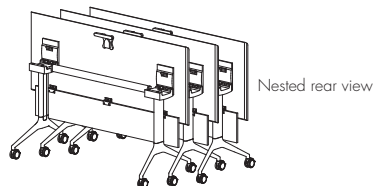
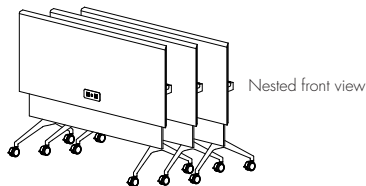
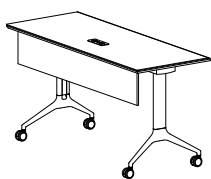

- » 8" high x 1/2" thick panels available on fixed or flip-up tables.
- » Offered in maple, walnut and white oak, in all standard and custom wood finishes, as well as laminate and Fenix selections.
- » Panels specified with veneer, standard wood grain or solid black laminate, and Fenix Nero Ingo (black), edge finish will match, unless otherwise specified.
- » Panels specified with all other standard solid color laminates and Fenix options, edge finish will be natural exposed plywood with a clear coat finish, as standard.
- » Finish is applied to both sides of modesty panel.
- » Panels flip downward when applied to flip-up tables to maintain nesting capability.
- » In-field installation required.

POWER UNITS:

- » Available on all flip-up and fixed tables.
- » Black or white finish with 120" electrical cord (no hardwire option available for this series).
- » UL listed.

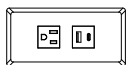

PX3
5 7/8" W x 2 7/8" D
One outlet, one USB-A and one USB-C charging port



PX4
7 1/4" W x 2 7/8" D
Two outlets, one USB-A and one USB-C charging port

- » Clips for horizontal wire management affixed to underside of table tops for convenient accessibility (included only when power is specified).
- » **For daisy chain requirements and pricing, please refer to pages 4-5.**

ORDERING REQUIREMENTS:

- » Model number
- » Wood species
- » Wood finish
- » Edge detail
- » Leg placement
- » Metal leg finish
- » Options, as applicable

FLIRT® MULTI-PURPOSE MEETING TABLES // DESIGNED BY 5D STUDIO

POWER UNIT STANDARD LOCATIONS (FOR CUSTOM PLACEMENT, PLEASE CONTACT CLIENT SERVICES):

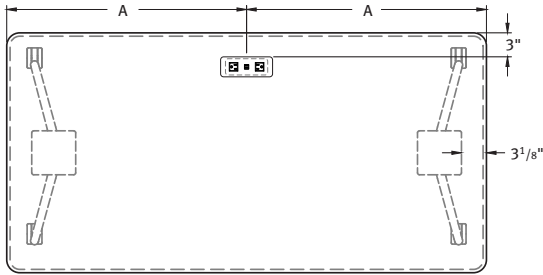

Rectangle Table - 1 Power Unit

LENGTH	A
48"	24"
60"	30"
66"	33"
72"	36"
78"	39"
84"	42"

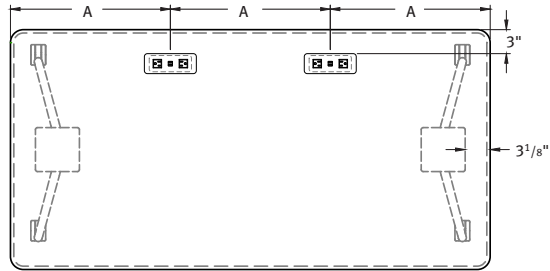

Rectangle Table - 2 Power Units

LENGTH	A
48"	16"
60"	20"
66"	22"
72"	24"
78"	26"
84"	28"

GROMMET:



- » Available on all flip-up and fixed tables, excluding corner connecting table.
- » Dimensions: 2" outer diameter x 1⁵/₈" inner diameter x 5⁵/₈" deep.
- » 5⁵/₈" cord slot.
- » Available in black and chrome finishes.
- » Please specify location on table surface.



DAISY CHAIN ELECTRICAL SPECIFICATIONS:

- » Daisy chain units are required for end-to-end or ganging connections, as well as when two electrical units are specified on one top.
- » To determine jumper cable length, measure length from edge of electrical unit to end of table.
- » **Ganging connectors are required for all daisy chain applications.**
- » Note: Always disconnect cables prior to separating tables.

FLIRT® MULTI-PURPOSE MEETING TABLES // DESIGNED BY 5D STUDIO

DAISY CHAIN ELECTRICAL UNIT NOTES:

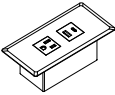
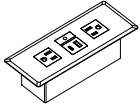
- » Daisy chain units are required when more than one electrical unit is specified on one top.
- » To determine jumper cable length, measure length from edge of electrical unit to end of table.

MODEL NUMBER	PRODUCT SPECIFICATIONS	LIST												
PX3-DC-B (BLACK FINISH) PX3-DC-W (WHITE FINISH) 	Power Matrix 3 Daisy Chain <ul style="list-style-type: none"> » Dimensions: 5⁷/₈" W x 2⁷/₈" D » One (1) outlet, one (1) USB-A and one (1) USB-C charging port » Includes splitter for connection with starter cable and jumper cables » UL listed 	554												
PX4-DC-B (BLACK FINISH) PX4-DC-W (WHITE FINISH) 	Power Matrix 4 Daisy Chain <ul style="list-style-type: none"> » Dimensions: 7¹/₄" W x 2⁷/₈" D » Two (2) outlets, one (1) USB-A and one (1) USB-C charging port » Includes splitter for connection with starter cable and jumper cables » UL listed 	580												
ST-DC 	Starter Cable, 124" Total Length <ul style="list-style-type: none"> » Corded plug infeed » Connects from power source in wall or floor to first PX3-DC or PX4-DC unit » Includes convenience outlet 	184												
JC-DC-() 	Jumper Cables <ul style="list-style-type: none"> » Typically used to connect two (2) units together <table border="1" style="margin-top: 10px;"> <thead> <tr> <th>MODEL</th> <th>LENGTH</th> <th>LIST</th> </tr> </thead> <tbody> <tr> <td>JC-DC-48</td> <td>48"</td> <td>112</td> </tr> <tr> <td>JC-DC-60</td> <td>60"</td> <td>120</td> </tr> <tr> <td>JC-DC-72</td> <td>72"</td> <td>126</td> </tr> </tbody> </table>	MODEL	LENGTH	LIST	JC-DC-48	48"	112	JC-DC-60	60"	120	JC-DC-72	72"	126	SEE TABLE
MODEL	LENGTH	LIST												
JC-DC-48	48"	112												
JC-DC-60	60"	120												
JC-DC-72	72"	126												

FLIRT® MULTI-PURPOSE MEETING TABLES // DESIGNED BY 5D STUDIO



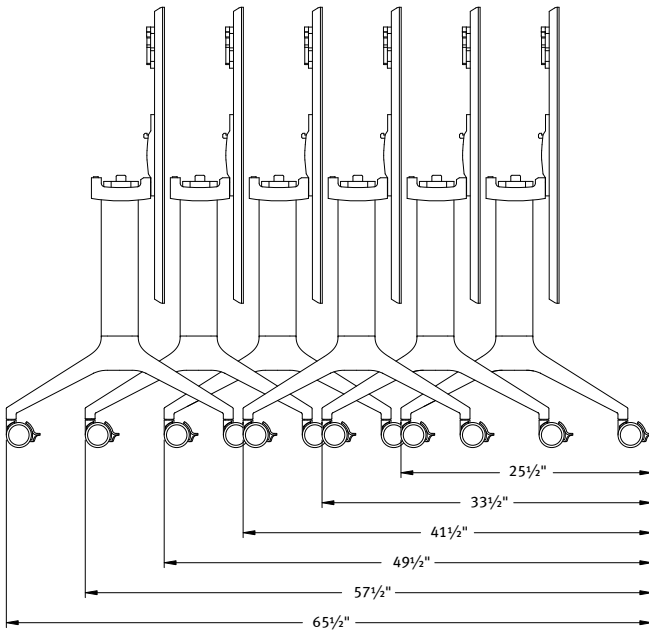
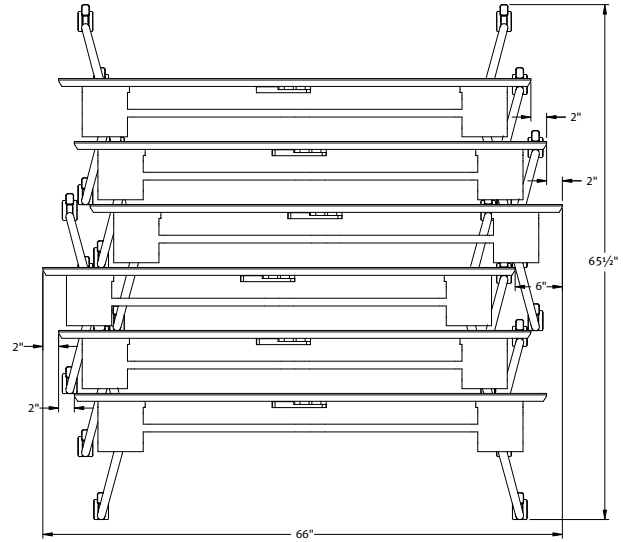
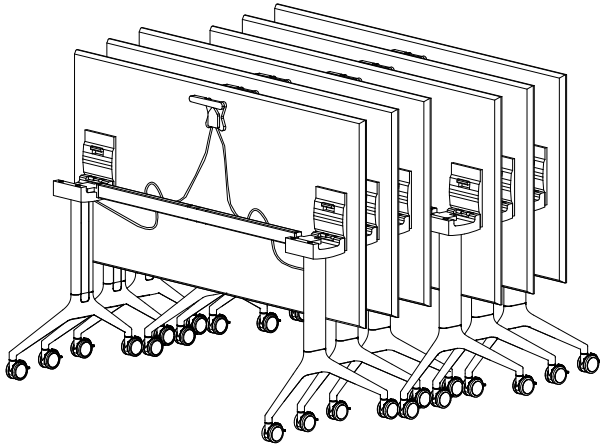

NESTING DIMENSIONS (BASED ON 66" TABLE LENGTH):



FLIRT® MULTI-PURPOSE MEETING TABLES // DESIGNED BY 5D STUDIO

ORDERING REQUIREMENTS:

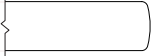
- » Model number
- » Wood species
- » Wood finish
- » Edge detail
- » Leg placement
- » Leg finish
- » Options, as applicable

	MODEL NUMBER	VENEER/LAMINATE EASED, BEVELED AND ONE-SIDED WATERFALL (-WF1)	VENEER OR LAMINATE TWO-SIDED WATERFALL (-WF2)	FENIX (-FE) EASED OR BEVELED EDGE	WEIGHT
FX1 SERIES					
Rectangle Fixed Top 27" High, Casters					
 Edge Mount Leg Placement	24" W x 48" L x 27" H	FX1-244827-(-)(-)	2661	N/A	46
	24" W x 60" L x 27" H	FX1-246027-(-)(-)	3430	N/A	53
	24" W x 66" L x 27" H	FX1-246627-(-)(-)	3515	N/A	56
	24" W x 72" L x 27" H	FX1-247227-(-)(-)	3596	N/A	59
	24" W x 78" L x 27" H	FX1-247827-(-)(-)	4180	N/A	62
	24" W x 84" L x 27" H	FX1-248427-(-)(-)	4248	N/A	66
 Inset Mount Leg Placement (not available on 48" length)	30" W x 48" L x 27" H	FX1-304827-(-)(-)	3291	N/A	53
	30" W x 60" L x 27" H	FX1-306027-(-)(-)	3840	N/A	61
	30" W x 66" L x 27" H	FX1-306627-(-)(-)	4160	N/A	65
	30" W x 72" L x 27" H	FX1-307227-(-)(-)	4313	N/A	69
	30" W x 78" L x 27" H	FX1-307827-(-)(-)	5471	N/A	73
	30" W x 84" L x 27" H	FX1-308427-(-)(-)	5553	N/A	77
Specify Leg Placement					
Edge Mount (-EM)	36" W x 48" L x 27" H	FX1-364827-(-)(-)	3443	3659	61
Inset Mount (-IM)	36" W x 60" L x 27" H	FX1-366027-(-)(-)	4196	4460	71
	36" W x 66" L x 27" H	FX1-366627-(-)(-)	4320	4606	76
	36" W x 72" L x 27" H	FX1-367227-(-)(-)	4472	4778	81
	36" W x 78" L x 27" H	FX1-367827-(-)(-)	5633	5958	85
	36" W x 84" L x 27" H	FX1-368427-(-)(-)	5717	6064	90
Specify Edge Style					
 Eased (-ES)	42" W x 60" L x 27" H	FX1-426027-(-)(-)	4237	4501	80
	42" W x 66" L x 27" H	FX1-426627-(-)(-)	4451	4737	86
 Beveled (-BV)	42" W x 72" L x 27" H	FX1-427227-(-)(-)	4602	4908	91
	42" W x 78" L x 27" H	FX1-427827-(-)(-)	5765	6090	97
	42" W x 84" L x 27" H	FX1-428427-(-)(-)	5852	6199	97
					6950
 Waterfall (-WF1/-WF2)					

OPTIONS

-GD00	Glides	n/c
-NS04	Non-Skid Glides	29
-PFM06	Premium Metal Leg Finish	303
-PFW05	Premium Wood Finish	83
-GR01	2" Diameter Grommet, Black	91
-GR02	2" Diameter Grommet, Chrome	121
-PX3-(-)	Power Matrix 3 (one power, one USB-A, one USB-C)	514
-PX4-(-)	Power Matrix 4 (dual power, one USB-A, one USB-C)	538
GC05 (order separately)	Flirt Ganging Connector (per table joint)	133





Please refer to pages 4-5 for daisy chain electrical requirements.

Note: For power matrix faceplate, please specify black (-B) or white (-W) finish.

FLIRT® MULTI-PURPOSE MEETING TABLES // DESIGNED BY 5D STUDIO

ORDERING REQUIREMENTS:

- » Model number
- » Wood species
- » Wood finish
- » Edge detail
- » Leg placement
- » Leg finish
- » Options, as applicable

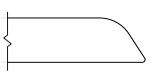
		MODEL NUMBER	VENEER/LAMINATE EASED, BEVELED AND ONE-SIDED WATERFALL (-WF1)	VENEER OR LAMINATE TWO-SIDED WATERFALL (-WF2)	FENIX (-FE) EASED OR BEVELED EDGE	WEIGHT
FX1 SERIES						
Rectangle Fixed Top 29" High, Casters						
 <p>Edge Mount Leg Placement</p>	24" W x 48" L x 29" H	FX1-244829-(-)(-)	2742	N/A	3101	48
	24" W x 60" L x 29" H	FX1-246029-(-)(-)	3511	N/A	3959	55
	24" W x 66" L x 29" H	FX1-246629-(-)(-)	3594	N/A	4087	58
	24" W x 72" L x 29" H	FX1-247229-(-)(-)	3676	N/A	4214	61
	24" W x 78" L x 29" H	FX1-247829-(-)(-)	4260	N/A	4843	64
	24" W x 84" L x 29" H	FX1-248429-(-)(-)	4327	N/A	4955	68
 <p>Inset Mount Leg Placement (not available on 48" length)</p>	30" W x 48" L x 29" H	FX1-304829-(-)(-)	3370	N/A	3818	55
	30" W x 60" L x 29" H	FX1-306029-(-)(-)	3918	N/A	4478	63
	30" W x 66" L x 29" H	FX1-306629-(-)(-)	4321	N/A	4937	67
	30" W x 72" L x 29" H	FX1-307229-(-)(-)	4614	N/A	5286	71
	30" W x 78" L x 29" H	FX1-307829-(-)(-)	5552	N/A	6280	75
	30" W x 84" L x 29" H	FX1-308429-(-)(-)	5632	N/A	6416	79
Specify Leg Placement						
Edge Mount (-EM)						
Inset Mount (-IM)						
Specify Edge Style						
 <p>Eased (-ES)</p>	36" W x 48" L x 29" H	FX1-364829-(-)(-)	3524	3740	4062	63
	36" W x 60" L x 29" H	FX1-366029-(-)(-)	4282	4546	4954	73
	36" W x 66" L x 29" H	FX1-366629-(-)(-)	4488	4774	4937	78
	36" W x 72" L x 29" H	FX1-367229-(-)(-)	4554	4860	5361	83
	36" W x 78" L x 29" H	FX1-367829-(-)(-)	5715	6040	6589	87
	36" W x 84" L x 29" H	FX1-368429-(-)(-)	5796	6143	6737	92
 <p>Beveled (-BV)</p>	42" W x 60" L x 29" H	FX1-426029-(-)(-)	4320	4584	5104	82
	42" W x 66" L x 29" H	FX1-426629-(-)(-)	4619	4905	5482	88
	42" W x 72" L x 29" H	FX1-427229-(-)(-)	4685	4991	5626	93
	42" W x 78" L x 29" H	FX1-427829-(-)(-)	5845	6170	6864	99
	42" W x 84" L x 29" H	FX1-428429-(-)(-)	5933	6280	7031	105
	 <p>Waterfall (-WF1/-WF2)</p>					

OPTIONS

-GD00	Glides	n/c
-NS04	Non-Skid Glides	29
-PFM06	Premium Metal Leg Finish	303
-PFW05	Premium Wood Finish	83
-GR01	2" Diameter Grommet, Black	91
-GR02	2" Diameter Grommet, Chrome	121
-PX3(-)	Power Matrix 3 (one power, one USB-A, one USB-C)	514
-PX4(-)	Power Matrix 4 (dual power, one USB-A, one USB-C)	538
GC05 (order separately)	Flirt Ganging Connector (per table joint)	133



Please refer to pages 4-5 for daisy chain electrical requirements.

Note: For power matrix faceplate, please specify black (-B) or white (-W) finish.

FLIRT® MULTI-PURPOSE MEETING TABLES // DESIGNED BY 5D STUDIO

ORDERING REQUIREMENTS:

- » Model number
- » Wood species
- » Wood finish
- » Edge detail
- » Leg placement
- » Leg finish
- » Options, as applicable

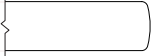
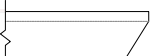
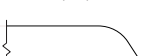
		MODEL NUMBER	VENEER/LAMINATE EASED, BEVELED AND ONE-SIDED WATERFALL (-WF1)	VENEER OR LAMINATE TWO-SIDED WATERFALL (-WF2)	FENIX (-FE) EASED OR BEVELED EDGE	WEIGHT
FX1 SERIES						
Rectangle Fixed Top 42" High, Casters						
 <p>Edge Mount Leg Placement</p>	24" W x 60" L x 42" H	FX1-246042(-)-(-)	4459	N/A	4907	61
	24" W x 72" L x 42" H	FX1-247242(-)-(-)	4599	N/A	5137	67
	24" W x 84" L x 42" H	FX1-248442(-)-(-)	4851	N/A	5479	74
 <p>Inset Mount Leg Placement (not available on 48" length)</p>	30" W x 60" L x 42" H	FX1-306042(-)-(-)	4865	N/A	5425	69
	30" W x 72" L x 42" H	FX1-307242(-)-(-)	5422	N/A	6094	77
	30" W x 84" L x 42" H	FX1-308442(-)-(-)	6156	N/A	6940	85
Specify Leg Placement Edge Mount (-EM) Inset Mount (-IM)	42" W x 60" L x 42" H	FX1-426042(-)-(-)	5294	5558	6078	91
	42" W x 72" L x 42" H	FX1-427242(-)-(-)	5720	6026	6661	102
	42" W x 84" L x 42" H	FX1-428442(-)-(-)	6453	6800	7551	114
Specify Edge Style						
 <p>Eased (-ES)</p>						
 <p>Beveled (-BV)</p>						
 <p>Waterfall (-WF1/-WF2)</p>						

OPTIONS

-GD00	Glides	n/c
-NS04	Non-Skid Glides	29
-PFM06	Premium Metal Leg Finish	303
-PFW05	Premium Wood Finish	83
-GR01	2" Diameter Grommet, Black	91
-GR02	2" Diameter Grommet, Chrome	121
-PX3(-)	Power Matrix 3 (one power, one USB-A, one USB-C)	514
-PX4(-)	Power Matrix 4 (dual power, one USB-A, one USB-C)	538
GC05 (order separately)	Flirt Ganging Connector (per table joint)	133

Please refer to pages 4-5 for daisy chain electrical requirements.

Note: For power matrix faceplate, please specify black (-B) or white (-W) finish.

FLIRT® MULTI-PURPOSE MEETING TABLES // DESIGNED BY 5D STUDIO

ORDERING REQUIREMENTS:

- » Model number
- » Wood species
- » Wood finish
- » Edge detail
- » Leg placement
- » Leg finish
- » Options, as applicable

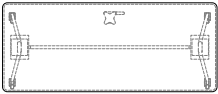
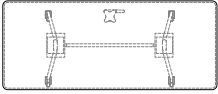
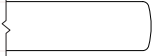
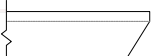
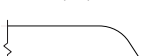
		MODEL NUMBER	VENEER/LAMINATE EASED, BEVELED AND ONE-SIDED WATERFALL (-WF1)	VENEER OR LAMINATE TWO-SIDED WATERFALL (-WF2)	FENIX (-FE) EASED OR BEVELED EDGE	WEIGHT
FP1 SERIES						
Rectangle Flip-Up Top, 27" High, Casters						
 <p>Edge Mount Leg Placement</p>	24" W x 48" L x 27" H	FP1-244827-(-)(-)	3743	N/A	4102	49
	24" W x 60" L x 27" H	FP1-246027-(-)(-)	4432	N/A	4880	56
	24" W x 66" L x 27" H	FP1-246627-(-)(-)	4560	N/A	5053	59
	24" W x 72" L x 27" H	FP1-247227-(-)(-)	4642	N/A	5180	62
	24" W x 78" L x 27" H	FP1-247827-(-)(-)	5315	N/A	5898	65
	24" W x 84" L x 27" H	FP1-248427-(-)(-)	5382	N/A	6010	69
 <p>Inset Mount Leg Placement (not available on 48" length)</p>	30" W x 48" L x 27" H	FP1-304827-(-)(-)	4427	N/A	4875	56
	30" W x 60" L x 27" H	FP1-306027-(-)(-)	4838	N/A	5398	64
	30" W x 66" L x 27" H	FP1-306627-(-)(-)	5221	N/A	5837	68
	30" W x 72" L x 27" H	FP1-307227-(-)(-)	5359	N/A	6031	72
	30" W x 78" L x 27" H	FP1-307827-(-)(-)	6607	N/A	7335	76
	30" W x 84" L x 27" H	FP1-308427-(-)(-)	6687	N/A	7471	80
Specify Leg Placement						
Edge Mount (-EM)	36" W x 48" L x 27" H	FP1-364827-(-)(-)	4892	5108	5430	64
Inset Mount (-IM)	36" W x 60" L x 27" H	FP1-366027-(-)(-)	5342	5606	6014	74
	36" W x 66" L x 27" H	FP1-366627-(-)(-)	5381	5667	6121	79
	36" W x 72" L x 27" H	FP1-367227-(-)(-)	5517	5823	6324	84
	36" W x 78" L x 27" H	FP1-367827-(-)(-)	6768	7093	7642	88
	36" W x 84" L x 27" H	FP1-368427-(-)(-)	6851	7198	7792	93
Specify Edge Style						
 <p>Eased (-ES)</p>						
 <p>Beveled (-BV)</p>						
 <p>Waterfall (-WF1/-WF2)</p>						

OPTIONS

-GD00	Glides	n/c
-NS04	Non-Skid Glides	29
-PFM06	Premium Metal Leg Finish	303
-PFW05	Premium Wood Finish	83
-GR01	2" Diameter Grommet, Black	91
-GR02	2" Diameter Grommet, Chrome	121
-PX3-()	Power Matrix 3 (one power, one USB-A, one USB-C)	514
-PX4-()	Power Matrix 4 (dual power, one USB-A, one USB-C)	538
GC05 (order separately)	Flirt Ganging Connector (per table joint)	133



Please refer to pages 4-5 for daisy chain electrical requirements.

Note: For power matrix faceplate, please specify black (-B) or white (-W) finish.

FLIRT® MULTI-PURPOSE MEETING TABLES // DESIGNED BY 5D STUDIO

ORDERING REQUIREMENTS:

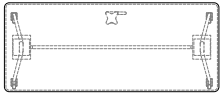
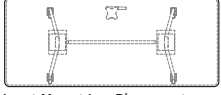
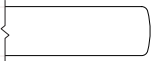
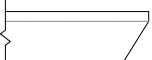
- » Model number
- » Wood species
- » Wood finish
- » Edge detail
- » Leg placement
- » Leg finish
- » Options, as applicable

		MODEL NUMBER	VENEER/LAMINATE EASED, BEVELED AND ONE-SIDED WATERFALL (-WF1)	VENEER OR LAMINATE TWO-SIDED WATERFALL (-WF2)	FENIX (-FE) EASED OR BEVELED EDGE	WEIGHT	
FP1 SERIES							
Rectangle Flip-Up Top, 29" High, Casters							
 <p>Edge Mount Leg Placement</p>	24" W x 48" L x 29" H	FP1-244829-(-)(-)	3823	N/A	4182	51	
	24" W x 60" L x 29" H	FP1-246029-(-)(-)	4510	N/A	4958	58	
	24" W x 66" L x 29" H	FP1-246629-(-)(-)	4638	N/A	5131	61	
	24" W x 72" L x 29" H	FP1-247229-(-)(-)	5150	N/A	5688	64	
	24" W x 78" L x 29" H	FP1-247829-(-)(-)	5882	N/A	6465	67	
	24" W x 84" L x 29" H	FP1-248429-(-)(-)	5957	N/A	6585	71	
 <p>Inset Mount Leg Placement (not available on 48" length)</p>	30" W x 48" L x 29" H	FP1-304829-(-)(-)	4507	N/A	4955	58	
	30" W x 60" L x 29" H	FP1-306029-(-)(-)	4919	N/A	5479	66	
	30" W x 66" L x 29" H	FP1-306629-(-)(-)	5301	N/A	5917	70	
	30" W x 72" L x 29" H	FP1-307229-(-)(-)	5592	N/A	6264	74	
	30" W x 78" L x 29" H	FP1-307829-(-)(-)	6684	N/A	7412	79	
	30" W x 84" L x 29" H	FP1-308429-(-)(-)	6766	N/A	7550	82	
Specify Leg Placement							
Edge Mount (-EM)							
Inset Mount (-IM)		36" W x 48" L x 29" H	FP1-364829-(-)(-)	4660	4876	5198	66
		36" W x 60" L x 29" H	FP1-366029-(-)(-)	5427	5691	6099	76
		36" W x 66" L x 29" H	FP1-366629-(-)(-)	5464	5750	6204	81
		36" W x 72" L x 29" H	FP1-367229-(-)(-)	5599	5905	6406	86
		36" W x 78" L x 29" H	FP1-367829-(-)(-)	6847	7172	7721	90
		36" W x 84" L x 29" H	FP1-368429-(-)(-)	6932	7279	7873	95
Specify Edge Style							
 <p>Eased (-ES)</p>							
 <p>Beveled (-BV)</p>							
 <p>Waterfall (-WF1/-WF2)</p>							

OPTIONS

-GD00	Glides	n/c
-NS04	Non-Skid Glides	29
-PFM06	Premium Metal Leg Finish	303
-PFW05	Premium Wood Finish	83
-GR01	2" Diameter Grommet, Black	91
-GR02	2" Diameter Grommet, Chrome	121
-PX3-(-)	Power Matrix 3 (one power, one USB-A, one USB-C)	514
-PX4-(-)	Power Matrix 4 (dual power, one USB-A, one USB-C)	538
GC05 (order separately)	Flirt Ganging Connector (per table joint)	133

Please refer to pages 4-5 for daisy chain electrical requirements.

Note: For power matrix faceplate, please specify black (-B) or white (-W) finish.



FLIRT® MULTI-PURPOSE MEETING TABLES // DESIGNED BY 5D STUDIO

MODESTY PANEL NOTES:

- » 8" high x 1/2" thick panels available on fixed or flip-up rectangle tables.
- » Power units not available on tables specified with modesty panels and inset mount bases.
- » Bottom of the panel from the floor dimension is as follows:
 - 27" high tables - 16 1/4"
 - 29" high tables - 19 1/4"
 - 42" high tables - 31 1/2"

ORDERING REQUIREMENTS:

- » Model number
- » Wood species
- » Wood finish

		MODEL NUMBER	PANEL LENGTH	VENEER OR LAMINATE	FENIX (-FE)	WEIGHT	
MODESTY PANELS 	Rectangle Top Edge Mount Table Bases Table Length 48" 60" 66" 72" 78" 84"	MP42 MP54 MP60 MP66 MP72 MP78	42" 54" 60" 66" 72" 78"	777 948 1036 1123 1210 1292	882 1083 1186 1288 1390 1487	5 6 7 8 9 10	
		Rectangle Top Inset Mount Table Bases Table Length 60" 66" 72" 78" 84"	MP30 MP36 MP42 MP48 MP54	30" 36" 42" 48" 54"	602 688 777 862 948	677 778 882 982 1083	3 5 6 7 8

OPTIONS

-PFW05	Premium Wood Finish	83
--------	---------------------	----

HAVEN GUEST SEATING



arcadia

MARCH 1, 2026
VA IDIQ CONTRACT (FY26)
(DEALER HELD)

HAVEN GUEST + TANDEM // DESIGNED BY DAVID DAHL



PRODUCT FEATURES:



ARM CAP:

- Radiused edges for smooth surface contact.
- Finger-grip design for added stability.
- Generously proportioned to provide greater support.
- Field-replaceable arm caps featured on all open arm models only.



FLEX BACK:

- Featured on all models.
- Passive flex back motion provides long-term seated comfort.



CLEAN-OUT PORTAL:

- Featured on all models.
- Clean-out area between seat and back enables crumbs and debris to fall through for maintenance ease.



METAL SEAT FRAME:

- Metal seat frame construction ensures durability and allows in-field component replacement as well as add-on capability for tandem units.



OPTIONAL REPLACEABLE UPHOLSTERY:

- Replaceable seat cover available on all models.
- Replaceable back cover available on all models, excluding the patient chair.
- Replacement seat and back covers can be easily field installed on previously ordered Haven models that were manufactured with replaceable seat and back covers. Contact client services for instructions.

HAVEN GUEST + TANDEM // DESIGNED BY DAVID DAHL

PRODUCT FEATURES CONTINUED:

- » Armless, open arm and inset panel arm options.
- » Frame available in beech wood or metal.
- » Wall-saver leg design.
- » All dimensions are nominal.

TANDEM + MODULAR FEATURES:

- » To build tandem configurations, always specify units from left-to-right, as facing.
- » Available in two and three-seat combinations or as reconfigurable modular units.
- » Bariatric settee and inline bench seats available in two sizes.
- » Multiple sizes of end, inline and corner tables available in beech veneer, laminate or with a Corian top.
- » Beech veneer and laminate tables are 3/4" thick with solid wood edge.
- » Corian tops are 1/2" thick.
- » **Note: Please include layout drawings or sketch with each order.**
- » Arcadia will pre-assemble units at the factory to maximize shipping allowances and minimize field assembly.

WEIGHT CAPACITY:

- » Guest Chair 350 lbs.
- » Reconfigurable Tandem 350 lbs. per seat
- » Bariatric Chairs 750 lbs.
- » Patient Chair 350 lbs.
- » Easy Access/Hip Chair 350 lbs.

SPECIFICATIONS:

- » All standard and custom wood finishes available on beech.
- » For Super Matte Sable Beech, premium wood finish upcharge applies. Refer to options section for pricing.
- » For custom wood finishes, please add one-time upcharge of \$514 List per color per order.
- » Metal frame available in two standard finishes. For non-standard options, please contact client services.
- » Four arm cap options: beech wood, black urethane or Corian.
- » Corian arm caps and inline tables available in six standard colors. For non-standard colors, please contact client services for pricing.
- » For custom laminates (applies to connecting tables only), add \$642 List per color per order. Pre-approval required, please contact client services.

CORIAN® COLORS:

- » CWN Designer White
- » CLN Linen
- » CTD Witch Hazel
- » CRC Rain Cloud
- » CGQ Grey Onyx
- » CSQ Stonique

METAL FRAME FINISHES:

- » 0405 Charcoal Grey
- » 0535 Metallic Silver

ORDERING REQUIREMENTS:





- » Model number
- » Frame finish
- » Arm cap finish, as applicable
- » Upholstery selection
- » Options, as applicable

HAVEN GUEST + TANDEM // DESIGNED BY DAVID DAHL

ORDERING REQUIREMENTS:

- » Model number
- » Upholstery selection
- » Frame finish
- » Options, as applicable
- » Arm cap finish, as applicable

Note: For Corian arm caps, specify '-CO' in place of '-W' after model number and refer to options below for upcharge.

MODEL NUMBER	PRODUCT SPECIFICATIONS	FABRIC GRADES										LEATHER				
		COM	A	1	2	COL					3	4	5	6	7	8
4910-W M4910-W (METAL FRAME) 	☼ Guest Chair, Open Arm Wood Arm Caps W 25 D 25 ³ / ₄ H 34 Seat Height 18 Inside Seat Width 21 Inside Seat Depth 18 ¹ / ₂ Arm Height 25 ³ / ₄ 1 ³ / ₄ yds. 39 lbs. COL 35 sq. ft.	Wood Frame	1789	1903	1959	1994	2050	2111	2169	2227	2281	2346	2610	2811		
		Metal Frame	1735	1849	1905	1940	1996	2057	2115	2173	2227	2292	2556	2757		
4910-W-PA M4910-W-PA (METAL FRAME) 	☼ Guest Chair, Panel Arm Wood Arm Caps W 25 D 25 ³ / ₄ H 34 Seat Height 18 Inside Seat Width 21 Inside Seat Depth 18 ¹ / ₂ Arm Height 25 ³ / ₄ 2 ³ / ₄ yds. 45 lbs. COL 55 sq. ft.	Wood Frame	2089	2268	2356	2411	2499	2595	2686	2777	2862	2964	3379	3695		
		Metal Frame	2035	2214	2302	2357	2445	2541	2632	2723	2808	2910	3325	3641		
4910-U M4910-U (METAL FRAME) 	☼ Guest Chair, Open Arm Black Urethane Arm Caps W 25 D 25 ³ / ₄ H 34 Seat Height 18 Inside Seat Width 21 Inside Seat Depth 18 ¹ / ₂ Arm Height 25 ³ / ₄ 1 ³ / ₄ yds. 39 lbs. COL 35 sq. ft.	Wood Frame	1789	1903	1959	1994	2050	2111	2169	2227	2281	2346	2610	2811		
		Metal Frame	1735	1849	1905	1940	1996	2057	2115	2173	2227	2292	2556	2757		
4910-U-PA M4910-U-PA (METAL FRAME) 	☼ Guest Chair, Panel Arm Black Urethane Arm Caps W 25 D 25 ³ / ₄ H 34 Seat Height 18 Inside Seat Width 21 Inside Seat Depth 18 ¹ / ₂ Arm Height 25 ³ / ₄ 2 ³ / ₄ yds. 45 lbs. COL 55 sq. ft.	Wood Frame	2089	2268	2356	2411	2499	2595	2686	2777	2862	2964	3379	3695		
		Metal Frame	2035	2214	2302	2357	2445	2541	2632	2723	2808	2910	3325	3641		

OPTIONS

-PFW01	Premium Wood Finish, Arm Cap (per arm)	12
-PFW04	Premium Wood Finish, Frame	34
-CO01	Corian Arm Cap (per arm)	84
-SC01	Replaceable Seat Cover	64
-BC01	Replaceable Back Cover	42
-MB01	Moisture Barrier (seat only)	69
-NS04	Non-Skid Glides	29

☼ = Available on quick-ship program, wood (all standard finishes) or metal frame (metallic silver finish only).

HAVEN GUEST + TANDEM // DESIGNED BY DAVID DAHL

ORDERING REQUIREMENTS:

- » Model number » Upholstery selection
- » Frame finish » Options, as applicable
- » Arm cap finish, as applicable

Note: For Corian arm caps, specify '-CO' in place of '-W' after model number and refer to options below for upcharge.

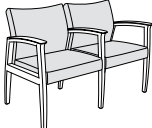
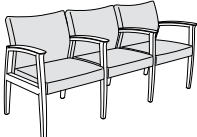
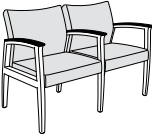
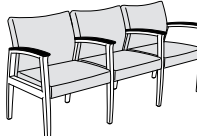
MODEL NUMBER	PRODUCT SPECIFICATIONS	FABRIC GRADES										LEATHER				
		COM	A	1	2	COL			3	4	5	6	7	8	L1	L2
4910-2-W M4910-2-W (METAL FRAME) 	Two-Seater, Wood Arm Caps W 48 D 25 ³ / ₄ H 34 Seat Height 18 Inside Seat Width 21 Inside Seat Depth 18 ¹ / ₂ Arm Height 25 ³ / ₄ 3 ¹ / ₂ yds. 73 lbs. COL 70 sq. ft.	Wood Frame	3118	3346	3458	3528	3640	3762	3878	3993	4102	4231	4760	5162		
		Metal Frame	2937	3165	3277	3347	3459	3581	3697	3812	3921	4050	4579	4981		
4910-3-W M4910-3-W (METAL FRAME) 	Three-Seater, Wood Arm Caps W 72 D 25 ³ / ₄ H 34 Seat Height 18 Inside Seat Width 21 Inside Seat Depth 18 ¹ / ₂ Arm Height 25 ³ / ₄ 5 ¹ / ₄ yds. 107 lbs. COL 105 sq. ft.	Wood Frame	4314	4656	4824	4929	5097	5280	5454	5627	5790	5984	6777	7380		
		Metal Frame	4187	4529	4697	4802	4970	5153	5327	5500	5663	5857	6650	7253		
4910-2-U M4910-2-U (METAL FRAME) 	Two-Seater, Black Urethane Arm Caps W 48 D 25 ³ / ₄ H 34 Seat Height 18 Inside Seat Width 21 Inside Seat Depth 18 ¹ / ₂ Arm Height 25 ³ / ₄ 3 ¹ / ₂ yds. 73 lbs. COL 70 sq. ft.	Wood Frame	3118	3346	3458	3528	3640	3762	3878	3993	4102	4231	4760	5162		
		Metal Frame	2937	3165	3277	3347	3459	3581	3697	3812	3921	4050	4579	4981		
4910-3-U M4910-3-U (METAL FRAME) 	Three-Seater, Black Urethane Arm Caps W 72 D 25 ³ / ₄ H 34 Seat Height 18 Inside Seat Width 21 Inside Seat Depth 18 ¹ / ₂ Arm Height 25 ³ / ₄ 5 ¹ / ₄ yds. 107 lbs. COL 105 sq. ft.	Wood Frame	4314	4656	4824	4929	5097	5280	5454	5627	5790	5984	6777	7380		
		Metal Frame	4187	4529	4697	4802	4970	5153	5327	5500	5663	5857	6650	7253		
-PA	Upholstered Inset Panel Arm (wood or metal frame, per arm) 1/2 yd.		150	183	199	209	225	242	259	275	291	309	385	442		

OPTIONS

-PFW01	Premium Wood Finish, Arm Cap (per arm)	12
-PFW04	Premium Wood Finish, Frame	34
-CO01	Corian Arm Cap (per arm)	84
-SC01	Replaceable Seat Cover (per seat)	64
-BC01	Replaceable Back Cover (per back)	42
-MB01	Moisture Barrier (seat only, per seat)	69
-NS02	Non-Skid Glides (per arm frame)	15

HAVEN GUEST + TANDEM // DESIGNED BY DAVID DAHL

ORDERING REQUIREMENTS:

- » Model number
- » Frame finish
- » Upholstery selection
- » Options, as applicable

MODEL NUMBER	PRODUCT SPECIFICATIONS		FABRIC GRADES										LEATHER	
			COM	A	1	2	COL		3	4	5	6	7	8
4915 M4915 (METAL FRAME) 	Guest Chair, Armless W 24 ¹ / ₂ D 25 ³ / ₄ H 34 Seat Height 18 Inside Seat Width 21 Inside Seat Depth 18 ¹ / ₂ 1 ³ / ₄ yds. 34 lbs. COL 35 sq. ft.	Wood Frame	1629	1743	1799	1834	1890	1951	2009	2067	2121	2186	2450	2651
		Metal Frame	1551	1665	1721	1756	1812	1873	1931	1989	2043	2108	2372	2573

OPTIONS







-PFW04	Premium Wood Finish, Frame	34
-SC01	Replaceable Seat Cover	64
-BC01	Replaceable Back Cover	42
-MB01	Moisture Barrier (seat only)	69
-NS04	Non-Skid Glides	29

HAVEN GUEST + TANDEM // DESIGNED BY DAVID DAHL

ORDERING REQUIREMENTS:

- » Model number
- » Table top finish
- » Leg finish, as applicable
- » Options, as applicable

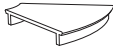
Note: All tables are field installed.

MODEL NUMBER	PRODUCT SPECIFICATIONS	TABLE TOP FINISH		
		VENEER OR LAMINATE	CORIAN (-CO)	
4917-15 M4917-15 (METAL FRAME UNITS) 	15" Center Table Inline Add-On W 15 D 21 13 lbs.	Wood Frame	899	1512
		Metal Frame	882	1487
4917-22 M4917-22 (METAL FRAME UNITS) 	22" Center Table Inline Add-On W 22 D 21 14 lbs.	Wood Frame	1062	1831
		Metal Frame	1065	1800
4918-15 M4918-15 (METAL LEGS) 	15" Wide End Table W 15 D 21 17 lbs.	Wood Frame	1095	1708
		Metal Frame	1063	1676
4918-22 M4918-22 (METAL LEGS) 	22" Wide End Table W 22 D 21 18 lbs.	Wood Frame	1192	1956
		Metal Frame	1176	1922
4919-45 M4919-45 (METAL FRAME UNITS) 	45-Degree Corner Table W 20 D 21 11 lbs.	Wood Frame	1094	1797
		Metal Frame	1095	1766
4919-90 M4919-90 (METAL FRAME UNITS) 	90-Degree Corner Table W 40 D 21 16 lbs.	Wood Frame	1261	2452
		Metal Frame	1267	2416

OPTIONS

-PFW04	Premium Wood Finish	44
-NS02	Non-Skid Glides	15

HAVEN GUEST + TANDEM // DESIGNED BY DAVID DAHL

ORDERING GUIDELINES:

- » To build tandem configurations, always specify units from left-to-right as facing.
- » Starter units ('-ST') represent the first seating model in a configuration with subsequent modular units building onto them towards the right.
- » Add-On units ('-AO') can only be added next to Starter units or other Add-On units.
- » End-units ('-EU') represent the final seating model in a configuration.
- » Center and corner tables are for inline placement only (cannot start or end a configuration) and for specification purposes, will always come before a Starter unit or after an End unit (i.e. Add-On units cannot be specified next to connecting tables).
- » End tables can only start or end a configuration, therefore they will always come before a Starter unit or after an End unit (i.e. Add-On units cannot be specified next to connecting tables).
- » For Corian arm caps, specify '-CO' in place of '-W' after model number and refer to options below for upcharge.

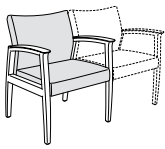
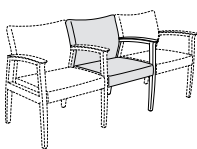
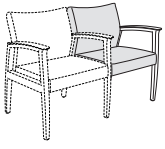
MODEL NUMBER	PRODUCT SPECIFICATIONS	FABRIC GRADES										LEATHER		
		COM	A	1	2	COL					L1	L2		
4920-ST-W M4920-ST-W (METAL FRAME) 	Tandem Starter Unit Wood Arm Caps W 25 D 25 ³ / ₄ H 34 Seat Height 18 Inside Seat Width 21 Inside Seat Depth 18 ¹ / ₂ Arm Height 25 ³ / ₄ 1 ³ / ₄ yds. 39 lbs. COL 35 sq. ft.	Wood Frame	1842	1956	2012	2047	2103	2164	2222	2280	2334	2399	2663	2864
		Metal Frame	1719	1833	1889	1924	1980	2041	2099	2157	2211	2276	2540	2741
4920-AO-W M4920-AO-W (METAL FRAME) 	Tandem Add-On Unit Wood Arm Cap W 23 D 25 ³ / ₄ H 34 Seat Height 18 Inside Seat Width 21 Inside Seat Depth 18 ¹ / ₂ Arm Height 25 ³ / ₄ 1 ³ / ₄ yds. 34 lbs. COL 35 sq. ft.	Wood Frame	1512	1626	1682	1717	1773	1834	1892	1950	2004	2069	2333	2534
		Metal Frame	1441	1555	1611	1646	1702	1763	1821	1879	1933	1998	2262	2463
4920-EU-W M4920-EU-W (METAL FRAME) 	Tandem End Unit Wood Arm Cap W 23 ¹ / ₂ D 25 ³ / ₄ H 34 Seat Height 18 Inside Seat Width 21 Inside Seat Depth 18 ¹ / ₂ Arm Height 25 ³ / ₄ 1 ³ / ₄ yds. 34 lbs. COL 35 sq. ft.	Wood Frame	1512	1626	1682	1717	1773	1834	1892	1950	2004	2069	2333	2534
		Metal Frame	1441	1555	1611	1646	1702	1763	1821	1879	1933	1998	2262	2463
-PA	Upholstered Inset Panel Arm (wood or metal frame, per arm) 1 ¹ / ₂ yd. COL 10 sq. ft.		150	183	199	209	225	242	259	275	291	309	385	442
	Connecting Tables Page 6 Inline Benches Page 11 Bariatric Models Pages 12-16													

OPTIONS

-PFW01	Premium Wood Finish, Arm Cap (per arm)	12
-PFW04	Premium Wood Finish, Frame	34
-CO01	Corian Arm Cap (per arm)	84
-SC01	Replaceable Seat Cover (per seat)	64
-BC01	Replaceable Back Cover (per back)	42
-MB01	Moisture Barrier (seat only, per seat)	69
-NS02	Non-Skid Glides (per arm frame)	15

HAVEN GUEST + TANDEM // DESIGNED BY DAVID DAHL

ORDERING GUIDELINES:

- » To build tandem configurations, always specify units from left-to-right as facing.
- » Starter units ('-ST') represent the first seating model in a configuration with subsequent modular units building onto them towards the right.
- » Add-On units ('-AO') can only be added next to Starter units or other Add-On units.
- » End-units ('-EU') represent the final seating model in a configuration.
- » Center and corner tables are for inline placement only (cannot start or end a configuration) and for specification purposes, will always come before a Starter unit or after an End unit (i.e. Add-On units cannot be specified next to connecting tables).
- » End tables can only start or end a configuration, therefore they will always come before a Starter unit or after an End unit (i.e. Add-On units cannot be specified next to connecting tables).

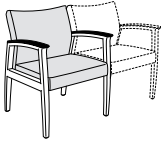
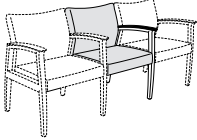
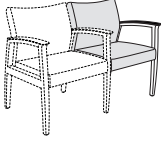
MODEL NUMBER	PRODUCT SPECIFICATIONS	FABRIC GRADES										LEATHER		
		COM	A	1	2	COL		3	4	5	6	7	8	L1
4920-ST-U M4920-ST-U (METAL FRAME) 	Tandem Starter Unit Black Urethane Arm Caps W 25 D 25 ³ / ₄ H 34 Seat Height 18 Inside Seat Width 21 Inside Seat Depth 18 ¹ / ₂ Arm Height 25 ³ / ₄ 1 ³ / ₄ yds. 39 lbs. COL 35 sq. ft.	Wood Frame	1842	1956	2012	2047	2103	2164	2222	2280	2334	2399	2663	2864
		Metal Frame	1719	1833	1889	1924	1980	2041	2099	2157	2211	2276	2540	2741
4920-AO-U M4920-AO-U (METAL FRAME) 	Tandem Add-On Unit Black Urethane Arm Cap W 23 D 25 ³ / ₄ H 34 Seat Height 18 Inside Seat Width 21 Inside Seat Depth 18 ¹ / ₂ Arm Height 25 ³ / ₄ 1 ³ / ₄ yds. 34 lbs. COL 35 sq. ft.	Wood Frame	1512	1626	1682	1717	1773	1834	1892	1950	2004	2069	2333	2534
		Metal Frame	1441	1555	1611	1646	1702	1763	1821	1879	1933	1998	2262	2463
4920-EU-U M4920-EU-U (METAL FRAME) 	Tandem End Unit Black Urethane Arm Cap W 23 ¹ / ₂ D 25 ³ / ₄ H 34 Seat Height 18 Inside Seat Width 21 Inside Seat Depth 18 ¹ / ₂ Arm Height 25 ³ / ₄ 1 ³ / ₄ yds. 34 lbs. COL 35 sq. ft.	Wood Frame	1512	1626	1682	1717	1773	1834	1892	1950	2004	2069	2333	2534
		Metal Frame	1441	1555	1611	1646	1702	1763	1821	1879	1933	1998	2262	2463
-PA	Upholstered Inset Panel Arm (wood or metal frame, per arm) 1/2 yd. COL 10 sq. ft.		150	183	199	209	225	242	259	275	291	309	385	442
	Connecting Tables Page 6 Inline Benches Page 11 Bariatric Models Pages 12-16													

OPTIONS		
-PFW04	Premium Wood Finish, Frame	34
-SC01	Replaceable Seat Cover (per seat)	64
-BC01	Replaceable Back Cover (per back)	42
-MB01	Moisture Barrier (seat only, per seat)	69
-NS02	Non-Skid Glides (per arm frame)	15

HAVEN GUEST + TANDEM // DESIGNED BY DAVID DAHL

ORDERING GUIDELINES:

- » To build tandem configurations, always specify units from left-to-right as facing.
- » Starter units ('-ST') represent the first seating model in a configuration with subsequent modular units building onto them towards the right.
- » Add-On units ('-AO') can only be added next to Starter units or other Add-On units.
- » End-units ('-EU') represent the final seating model in a configuration.
- » Center and corner tables are for inline placement only (cannot start or end a configuration) and for specification purposes, will always come before a Starter unit or after an End unit (i.e. Add-On units cannot be specified next to connecting tables).
- » End tables can only start or end a configuration, therefore they will always come before a Starter unit or after an End unit (i.e. Add-On units cannot be specified next to connecting tables).
- » For Corian arm caps, specify '-CO' in place of '-W' after model number and refer to options below for upcharge.

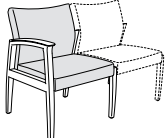
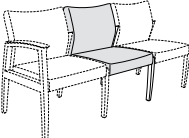
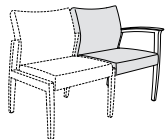
MODEL NUMBER	PRODUCT SPECIFICATIONS	FABRIC GRADES										LEATHER		
		COM	A	1	2	COL					L1	L2		
4925-ST-W M4925-ST-W (METAL FRAME) 	Tandem Starter Unit Wood Arm Cap/Armless W 24 ¹ / ₂ D 25 ³ / ₄ H 34 Seat Height 18 Inside Seat Width 21 Inside Seat Depth 18 ¹ / ₂ Arm Height 25 ³ / ₄ 1 ³ / ₄ yds. 35 lbs. COL 35 sq. ft.	Wood Frame	1683	1797	1853	1888	1944	2005	2063	2121	2175	2240	2504	2705
		Metal Frame	1618	1732	1788	1823	1879	1940	1998	2056	2110	2175	2439	2640
4925-AO M4925-AO (METAL FRAME) 	Tandem Add-On Unit Armless/Armless W 23 D 25 ³ / ₄ H 34 Seat Height 18 Inside Seat Width 21 Inside Seat Depth 18 ¹ / ₂ 1 ³ / ₄ yds. 33 lbs. COL 35 sq. ft.	Wood Frame	1344	1458	1514	1549	1605	1666	1724	1782	1836	1901	2165	2366
		Metal Frame	1268	1382	1438	1473	1529	1590	1648	1706	1760	1825	2089	2290
4925-EU-W M4925-EU-W (METAL FRAME) 	Tandem End Unit Armless/Wood Arm Cap W 24 ¹ / ₂ D 25 ³ / ₄ H 34 Seat Height 18 Inside Seat Width 21 Inside Seat Depth 18 ¹ / ₂ Arm Height 25 ³ / ₄ 1 ³ / ₄ yds. 35 lbs. COL 35 sq. ft.	Wood Frame	1667	1781	1837	1872	1928	1989	2047	2105	2159	2224	2488	2689
		Metal Frame	1618	1732	1788	1823	1879	1940	1998	2056	2110	2175	2439	2640
-PA	Upholstered Inset Panel Arm (wood or metal frame, per arm) 1 ¹ / ₂ yd. COL 10 sq. ft.		150	183	199	209	225	242	259	275	291	309	385	442
	Connecting Tables Page 6 Inline Benches Page 11 Bariatric Models Pages 12-16													

OPTIONS		
-PFW01	Premium Wood Finish, Arm Cap (per arm)	12
-PFW04	Premium Wood Finish, Frame	34
-CO01	Corian Arm Cap (per arm)	84
-SC01	Replaceable Seat Cover (per seat)	64
-BC01	Replaceable Back Cover (per back)	42
-MB01	Moisture Barrier (seat only, per seat)	69
-NS02	Non-Skid Glides (per arm frame)	15

HAVEN GUEST + TANDEM // DESIGNED BY DAVID DAHL

ORDERING GUIDELINES:

- » To build tandem configurations, always specify units from left-to-right as facing.
- » Starter units ('-ST') represent the first seating model in a configuration with subsequent modular units building onto them towards the right.
- » Add-On units ('-AO') can only be added next to Starter units or other Add-On units.
- » End-units ('-EU') represent the final seating model in a configuration.
- » Center and corner tables are for inline placement only (cannot start or end a configuration) and for specification purposes, will always come before a Starter unit or after an End unit (i.e. Add-On units cannot be specified next to connecting tables).
- » End tables can only start or end a configuration, therefore they will always come before a Starter unit or after an End unit (i.e. Add-On units cannot be specified next to connecting tables).

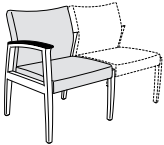
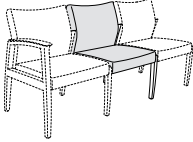
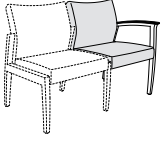
MODEL NUMBER	PRODUCT SPECIFICATIONS	FABRIC GRADES										LEATHER		
		COM	A	1	2	COL					8	L1	L2	
4925-ST-U M4925-ST-U (METAL FRAME) 	Tandem Starter Unit Black Urethane Arm Cap/Armless W 24 ¹ / ₂ D 25 ³ / ₄ H 34 Seat Height 18 Inside Seat Width 21 Inside Seat Depth 18 ¹ / ₂ Arm Height 25 ³ / ₄ 1 ³ / ₄ yds. 35 lbs. COL 35 sq. ft.	Wood Frame	1667	1781	1837	1872	1928	1989	2047	2105	2159	2224	2488	2689
		Metal Frame	1618	1732	1788	1823	1879	1940	1998	2056	2110	2175	2439	2640
4925-AO M4925-AO (METAL FRAME) 	Tandem Add-On Unit Armless/Armless W 23 D 25 ³ / ₄ H 34 Seat Height 18 Inside Seat Width 21 Inside Seat Depth 18 ¹ / ₂ 1 ³ / ₄ yds. 33 lbs. COL 35 sq. ft.	Wood Frame	1344	1458	1514	1549	1605	1666	1724	1782	1836	1901	2165	2366
		Metal Frame	1268	1382	1438	1473	1529	1590	1648	1706	1760	1825	2089	2290
4925-EU-U M4925-EU-U (METAL FRAME) 	Tandem End Unit Armless/Black Urethane Arm Cap W 24 ¹ / ₂ D 25 ³ / ₄ H 34 Seat Height 18 Inside Seat Width 21 Inside Seat Depth 18 ¹ / ₂ Arm Height 25 ³ / ₄ 1 ³ / ₄ yds. 35 lbs. COL 35 sq. ft.	Wood Frame	1667	1781	1837	1872	1928	1989	2047	2105	2159	2224	2488	2689
		Metal Frame	1618	1732	1788	1823	1879	1940	1998	2056	2110	2175	2439	2640
-PA	Upholstered Inset Panel Arm (wood or metal frame, per arm) 1 ¹ / ₂ yd. COL 10 sq. ft.		150	183	199	209	225	242	259	275	291	309	385	442
	Connecting Tables Page 6 Inline Benches Page 11 Bariatric Models Pages 12-16													

OPTIONS		
-PFW04	Premium Wood Finish, Frame	34
-SC01	Replaceable Seat Cover (per seat)	64
-BC01	Replaceable Back Cover (per back)	42
-MB01	Moisture Barrier (seat only, per seat)	69
-NS02	Non-Skid Glides (per arm frame)	15

HAVEN GUEST + TANDEM // DESIGNED BY DAVID DAHL

ORDERING GUIDELINES:

- » To build tandem configurations, always specify units from left-to-right as facing.
- » Starter units ('-ST') represent the first seating model in a configuration with subsequent modular units building onto them towards the right.
- » Add-On units ('-AO') can only be added next to Starter units or other Add-On units.
- » End-units ('-EU') represent the final seating model in a configuration.
- » Center and corner tables are for inline placement only (cannot start or end a configuration) and for specification purposes, will always come before a Starter unit or after an End unit (i.e. Add-On units cannot be specified next to connecting tables).
- » End tables can only start or end a configuration, therefore they will always come before a Starter unit or after an End unit (i.e. Add-On units cannot be specified next to connecting tables).
- » For Corian arm caps, specify '-CO' in place of '-W' after model number and refer to options below for upcharge.

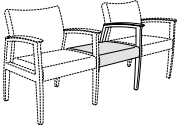
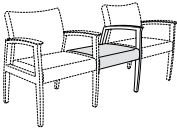
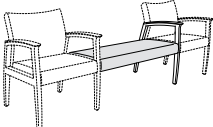
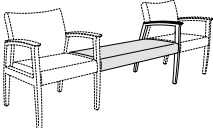
MODEL NUMBER	PRODUCT SPECIFICATIONS	FABRIC GRADES										LEATHER				
		COM	A	1	2	COL					3	4	5	6	7	8
4927-AO-W M4927-AO-W (METAL FRAME) 	21" Wide Inline Bench Single Arm, Wood Arm Cap W 21 D 18 Seat Height 18 Inside Seat Width 21 Inside Seat Depth 18 ¹ / ₂ Arm Height 25 ³ / ₄ 1 yd. 25 lbs. COL 20 sq. ft.	Wood Frame	1106	1171	1203	1223	1255	1290	1323	1356	1387	1424	1575	1690		
		Metal Frame	1063	1128	1160	1180	1212	1247	1280	1313	1344	1381	1532	1647		
4927-AO-U M4927-AO-U (METAL FRAME) 	21" Wide Inline Bench Single Arm, Urethane Arm Cap W 21 D 18 Seat Height 18 Inside Seat Width 21 Inside Seat Depth 18 ¹ / ₂ Arm Height 25 ³ / ₄ 1 yd. 25 lbs. COL 20 sq. ft.	Wood Frame	1106	1171	1203	1223	1255	1290	1323	1356	1387	1424	1575	1690		
		Metal Frame	1063	1128	1160	1180	1212	1247	1280	1313	1344	1381	1532	1647		
4928-AO-W M4928-AO-W (METAL FRAME) 	42" Wide Inline Bench Single Arm, Wood Arm Cap W 42 D 18 Seat Height 18 Inside Seat Width 42 Inside Seat Depth 18 ¹ / ₂ Arm Height 25 ³ / ₄ 1 ¹ / ₂ yds. 42 lbs. COL 30 sq. ft.	Wood Frame	1412	1510	1558	1588	1636	1688	1738	1787	1834	1889	2116	2288		
		Metal Frame	1372	1470	1518	1548	1596	1648	1698	1747	1794	1849	2076	2248		
4928-AO-U M4928-AO-U (METAL FRAME) 	42" Wide Inline Bench Single Arm, Urethane Arm Cap W 42 D 18 Seat Height 18 Inside Seat Width 42 Inside Seat Depth 18 ¹ / ₂ Arm Height 25 ³ / ₄ 1 ¹ / ₂ yds. 42 lbs. COL 30 sq. ft.	Wood Frame	1412	1510	1558	1588	1636	1688	1738	1787	1834	1889	2116	2288		
		Metal Frame	1372	1470	1518	1548	1596	1648	1698	1747	1794	1849	2076	2248		
	Tandem Seating	Pages 7-10														
	Connecting Tables	Page 6														
	Bariatric Models	Pages 12-16														





OPTIONS		
-PFW01	Premium Wood Finish, Arm Cap (per arm)	12
-PFW04	Premium Wood Finish, Frame	34
-CO01	Corian Arm Cap (per arm)	84
-SC01	Replaceable Seat Cover (21" bench)	64
-SC02	Replaceable Seat Cover (42" bench)	84
-MB01	Moisture Barrier (21" bench)	69
-MB02	Moisture Barrier (42" bench)	133
-NS02	Non-Skid Glides (per arm frame)	15

HAVEN GUEST + TANDEM // DESIGNED BY DAVID DAHL

ORDERING REQUIREMENTS:

- » Model number » Upholstery selection
- » Frame finish » Options, as applicable
- » Arm cap finish, as applicable

Note: For Corian arm caps, specify '-CO' in place of '-W' after model number and refer to options below for upcharge.

MODEL NUMBER	PRODUCT SPECIFICATIONS	FABRIC GRADES										LEATHER				
		COM	A	1	2	COL					3	4	5	6	7	8
4940-W M4940-W (METAL FRAME) 	Bariatric Settee, 34" Wide Wood Arm Caps W 34 D 25 ³ / ₄ H 34 Seat Height 18 Inside Seat Width 30 Inside Seat Depth 18 Arm Height 26 ¹ / ₂ 2 ¹ / ₂ yds. 51 lbs. COL 50 sq. ft.	Wood Frame	2281	2444	2524	2574	2654	2741	2824	2906	2984	3076	3454	3741		
		Metal Frame	2211	2374	2454	2504	2584	2671	2754	2836	2914	3006	3384	3671		
4940-U M4940-U (METAL FRAME) 	Bariatric Settee, 34" Wide Black Urethane Arm Caps W 34 D 25 ³ / ₄ H 34 Seat Height 18 Inside Seat Width 30 Inside Seat Depth 18 Arm Height 26 ¹ / ₂ 2 ¹ / ₂ yds. 51 lbs. COL 50 sq. ft.	Wood Frame	2281	2444	2524	2574	2654	2741	2824	2906	2984	3076	3454	3741		
		Metal Frame	2211	2374	2454	2504	2584	2671	2754	2836	2914	3006	3384	3671		
4945-W M4945-W (METAL FRAME) 	Bariatric Settee, 40" Wide Wood Arm Caps W 40 D 25 ³ / ₄ H 34 Seat Height 18 Inside Seat Width 36 Inside Seat Depth 18 Arm Height 26 ¹ / ₂ 3 yds. 75 lbs. COL 60 sq. ft.	Wood Frame	2609	2804	2900	2960	3056	3161	3260	3359	3452	3563	4016	4361		
		Metal Frame	2532	2727	2823	2883	2979	3084	3183	3282	3375	3486	3939	4284		
4945-U M4945-U (METAL FRAME) 	Bariatric Settee, 40" Wide Black Urethane Arm Caps W 40 D 25 ³ / ₄ H 34 Seat Height 18 Inside Seat Width 36 Inside Seat Depth 18 Arm Height 26 ¹ / ₂ 3 yds. 75 lbs. COL 60 sq. ft.	Wood Frame	2609	2804	2900	2960	3056	3161	3260	3359	3452	3563	4016	4361		
		Metal Frame	2532	2727	2823	2883	2979	3084	3183	3282	3375	3486	3939	4284		

OPTIONS

-PFW01	Premium Wood Finish, Arm Cap (per arm)	12
-PFW04	Premium Wood Finish, Frame	34
-CO01	Corian Arm Cap (per arm)	84
-SC02	Replaceable Seat Cover	84
-BC02	Replaceable Back Cover	64
-MB02	Moisture Barrier (seat only)	133
-NS04	Non-Skid Glides	29

HAVEN GUEST + TANDEM // DESIGNED BY DAVID DAHL

ORDERING GUIDELINES:

- » To build tandem configurations, always specify units from left-to-right as facing.
- » Starter units ('-ST') represent the first seating model in a configuration with subsequent modular units building onto them towards the right.
- » Add-On units ('-AO') can only be added next to Starter units or other Add-On units.
- » End-units ('-EU') represent the final seating model in a configuration.
- » Center and corner tables are for inline placement only (cannot start or end a configuration) and for specification purposes, will always come before a Starter unit or after an End unit (i.e. Add-On units cannot be specified next to connecting tables).
- » End tables can only start or end a configuration, therefore they will always come before a Starter unit or after an End unit (i.e. Add-On units cannot be specified next to connecting tables).
- » **Bariatric tandem chairs cannot be adjoined together side-by-side.**
- » For Corian arm caps, specify '-CO' in place of '-W' after model number and refer to options below for upcharge.

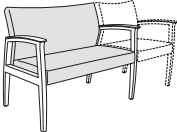
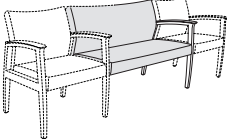
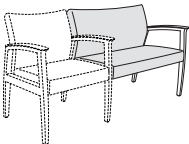
MODEL NUMBER	PRODUCT SPECIFICATIONS	FABRIC GRADES										LEATHER				
		COM	A	1	2	COL					3	4	5	6	7	8
4940-ST-W M4940-ST-W (METAL FRAME) 	Tandem Bariatric Starter Unit 34" Wide, Wood Arm Caps W 34 D 25 ³ / ₄ H 34 Seat Height 18 Inside Seat Width 30 Inside Seat Depth 18 Arm Height 26 ¹ / ₂ 2 ¹ / ₂ yds. 51 lbs. COL 50 sq. ft.	Wood Frame	2309	2472	2552	2602	2682	2769	2852	2934	3012	3104	3482	3769		
		Metal Frame	2242	2405	2485	2535	2615	2702	2785	2867	2945	3037	3415	3702		
4940-AO-W M4940-AO-W (METAL FRAME) 	Tandem Bariatric Add-On Unit 34" Wide, Wood Arm Cap W 32 D 25 ³ / ₄ H 34 Seat Height 18 Inside Seat Width 30 Inside Seat Depth 18 Arm Height 26 ¹ / ₂ 2 ¹ / ₂ yds. 47 lbs. COL 50 sq. ft.	Wood Frame	1974	2137	2217	2267	2347	2434	2517	2599	2677	2769	3147	3434		
		Metal Frame	1915	2078	2158	2208	2288	2375	2458	2540	2618	2710	3088	3375		
4940-EU-W M4940-EU-W (METAL FRAME) 	Tandem Bariatric End Unit 34" Wide, Wood Arm Cap W 32 ¹ / ₂ D 25 ³ / ₄ H 34 Seat Height 18 Inside Seat Width 30 Inside Seat Depth 18 Arm Height 26 ¹ / ₂ 2 ¹ / ₂ yds. 47 lbs. COL 50 sq. ft.	Wood Frame	1974	2137	2217	2267	2347	2434	2517	2599	2677	2769	3147	3434		
		Metal Frame	1915	2078	2158	2208	2288	2375	2458	2540	2618	2710	3088	3375		
-PA	Upholstered Inset Panel Arm (wood or metal frame, per arm) 1/2 yd.		150	183	199	209	225	242	259	275	291	309	385	442		
	Connecting Tables Page 6 Tandem Seating Pages 7-10 Inline Benches Page 11															

OPTIONS		
-PFW01	Premium Wood Finish, Arm Cap (per arm)	12
-PFW04	Premium Wood Finish, Frame	34
-CO01	Corian Arm Cap (per arm)	84
-SC02	Replaceable Seat Cover	84
-BC02	Replaceable Back Cover	64
-MB02	Moisture Barrier (seat only)	133
-NS04	Non-Skid Glides	29

HAVEN GUEST + TANDEM // DESIGNED BY DAVID DAHL

ORDERING GUIDELINES:

- » To build tandem configurations, always specify units from left-to-right as facing.
- » Starter units ('-ST') represent the first seating model in a configuration with subsequent modular units building onto them towards the right.
- » Add-On units ('-AO') can only be added next to Starter units or other Add-On units.
- » End-units ('-EU') represent the final seating model in a configuration.
- » Center and corner tables are for inline placement only (cannot start or end a configuration) and for specification purposes, will always come before a Starter unit or after an End unit (i.e. Add-On units cannot be specified next to connecting tables).
- » End tables can only start or end a configuration, therefore they will always come before a Starter unit or after an End unit (i.e. Add-On units cannot be specified next to connecting tables).
- » **Bariatric tandem chairs cannot be adjoined together side-by-side.**

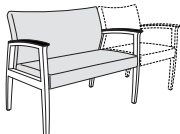
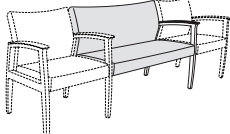
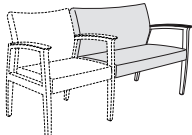
MODEL NUMBER	PRODUCT SPECIFICATIONS	FABRIC GRADES										LEATHER		
		COM	A	1	2	COL					L1	L2		
4940-ST-U M4940-ST-U (METAL FRAME) 	Tandem Bariatric Starter Unit 34" Wide, Black Urethane Arm Caps W 34 D 25 ³ / ₄ H 34 Seat Height 18 Inside Seat Width 30 Inside Seat Depth 18 Arm Height 26 ¹ / ₂ 2 ¹ / ₂ yds. 51 lbs. COL 50 sq. ft.	Wood Frame	2309	2472	2552	2602	2682	2769	2852	2934	3012	3104	3482	3769
		Metal Frame	2242	2405	2485	2535	2615	2702	2785	2867	2945	3037	3415	3702
4940-AO-U M4940-AO-U (METAL FRAME) 	Tandem Bariatric Add-On Unit 34" Wide, Black Urethane Arm Cap W 32 D 25 ³ / ₄ H 34 Seat Height 18 Inside Seat Width 30 Inside Seat Depth 18 Arm Height 26 ¹ / ₂ 2 ¹ / ₂ yds. 47 lbs. COL 50 sq. ft.	Wood Frame	1974	2137	2217	2267	2347	2434	2517	2599	2677	2769	3147	3434
		Metal Frame	1915	2078	2158	2208	2288	2375	2458	2540	2618	2710	3088	3375
4940-EU-U M4940-EU-U (METAL FRAME) 	Tandem Bariatric End Unit 34" Wide, Black Urethane Arm Cap W 32 ¹ / ₂ D 25 ³ / ₄ H 34 Seat Height 18 Inside Seat Width 30 Inside Seat Depth 18 Arm Height 26 ¹ / ₂ 2 ¹ / ₂ yds. 47 lbs. COL 50 sq. ft.	Wood Frame	1974	2137	2217	2267	2347	2434	2517	2599	2677	2769	3147	3434
		Metal Frame	1915	2078	2158	2208	2288	2375	2458	2540	2618	2710	3088	3375
-PA	Upholstered Inset Panel Arm (wood or metal frame, per arm) 1 ¹ / ₂ yd. COL 10 sq. ft.		150	183	199	209	225	242	259	275	291	309	385	442
	Connecting Tables Page 6 Tandem Seating Pages 7-10 Inline Benches Page 11													

OPTIONS		
-PFW04	Premium Wood Finish, Frame	34
-SC02	Replaceable Seat Cover (per seat)	84
-BC02	Replaceable Back Cover (per back)	64
-MB02	Moisture Barrier (seat only, per seat)	133
-NS02	Non-Skid Glides (per arm frame)	15

HAVEN GUEST + TANDEM // DESIGNED BY DAVID DAHL

ORDERING GUIDELINES:

- » To build tandem configurations, always specify units from left-to-right as facing.
- » Starter units ('-ST') represent the first seating model in a configuration with subsequent modular units building onto them towards the right.
- » Add-On units ('-AO') can only be added next to Starter units or other Add-On units.
- » End-units ('-EU') represent the final seating model in a configuration.
- » Center and corner tables are for inline placement only (cannot start or end a configuration) and for specification purposes, will always come before a Starter unit or after an End unit (i.e. Add-On units cannot be specified next to connecting tables).
- » End tables can only start or end a configuration, therefore they will always come before a Starter unit or after an End unit (i.e. Add-On units cannot be specified next to connecting tables).
- » **Bariatric tandem chairs cannot be adjoined together side-by-side.**
- » For Corian arm caps, specify '-CO' in place of '-W' after model number and refer to options below for upcharge.

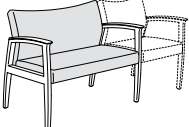
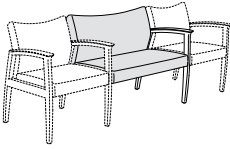
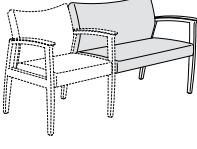
MODEL NUMBER	PRODUCT SPECIFICATIONS	FABRIC GRADES										LEATHER		
		COM	A	1	2	COL					L1	L2		
4945-ST-W M4945-ST-W (METAL FRAME) 	Tandem Bariatric Starter Unit 40" Wide, Wood Arm Caps W 40 D 25 ³ / ₄ H 34 Seat Height 18 Inside Seat Width 36 Inside Seat Depth 18 Arm Height 26 ¹ / ₂ 3 yds. 75 lbs. COL 60 sq. ft.	Wood Frame	2613	2808	2904	2964	3060	3165	3264	3363	3456	3567	4020	4365
		Metal Frame	2534	2729	2825	2885	2981	3086	3185	3284	3377	3488	3941	4286
4945-AO-W M4945-AO-W (METAL FRAME) 	Tandem Bariatric Add-On Unit 40" Wide, Wood Arm Cap W 38 D 25 ³ / ₄ H 34 Seat Height 18 Inside Seat Width 36 Inside Seat Depth 18 Arm Height 26 ¹ / ₂ 3 yds. 71 lbs. COL 60 sq. ft.	Wood Frame	2296	2491	2587	2647	2743	2848	2947	3046	3139	3250	3703	4048
		Metal Frame	2228	2423	2519	2579	2675	2780	2879	2978	3071	3182	3635	3980
4945-EU-W M4945-EU-W (METAL FRAME) 	Tandem Bariatric End Unit 40" Wide, Wood Arm Cap W 38 ¹ / ₂ D 25 ³ / ₄ H 34 Seat Height 18 Inside Seat Width 36 Inside Seat Depth 18 Arm Height 26 ¹ / ₂ 3 yds. 71 lbs. COL 60 sq. ft.	Wood Frame	2296	2491	2587	2647	2743	2848	2947	3046	3139	3250	3703	4048
		Metal Frame	2228	2423	2519	2579	2675	2780	2879	2978	3071	3182	3635	3980
-PA	Upholstered Inset Panel Arm (wood or metal frame, per arm) 1/2 yd. COL 10 sq. ft.		150	183	199	209	225	242	259	275	291	309	385	442

Connecting Tables Page 6
 Tandem Seating Pages 7-10
 Inline Benches Page 11

OPTIONS		
-PFW01	Premium Wood Finish, Arm Cap (per arm)	12
-PFW04	Premium Wood Finish, Frame	34
-CO01	Corian Arm Cap (per arm)	84
-SC02	Replaceable Seat Cover (per seat)	84
-BC02	Replaceable Back Cover (per back)	64
-MB02	Moisture Barrier (seat only, per seat)	133
-NS02	Non-Skid Glides (per arm frame)	15

HAVEN GUEST + TANDEM // DESIGNED BY DAVID DAHL

ORDERING GUIDELINES:

- » To build tandem configurations, always specify units from left-to-right as facing.
- » Starter units ('-ST') represent the first seating model in a configuration with subsequent modular units building onto them towards the right.
- » Add-On units ('-AO') can only be added next to Starter units or other Add-On units.
- » End-units ('-EU') represent the final seating model in a configuration.
- » Center and corner tables are for inline placement only (cannot start or end a configuration) and for specification purposes, will always come before a Starter unit or after an End unit (i.e. Add-On units cannot be specified next to connecting tables).
- » End tables can only start or end a configuration, therefore they will always come before a Starter unit or after an End unit (i.e. Add-On units cannot be specified next to connecting tables).
- » **Bariatric tandem chairs cannot be adjoined together side-by-side.**

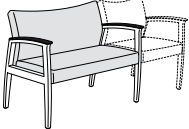
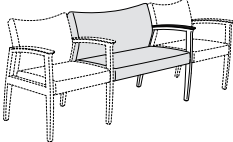
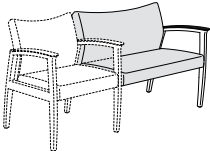
MODEL NUMBER	PRODUCT SPECIFICATIONS	FABRIC GRADES										LEATHER		
		COM	A	1	2	COL					L1	L2		
4945-ST-U M4945-ST-U (METAL FRAME) 	Tandem Bariatric Starter Unit 40" Wide, Black Urethane Arm Caps W 40 D 25 ³ / ₄ H 34 Seat Height 18 Inside Seat Width 36 Inside Seat Depth 18 Arm Height 26 ¹ / ₂ 3 yds. 75 lbs. COL 60 sq. ft.	Wood Frame	2613	2808	2904	2964	3060	3165	3264	3363	3456	3567	4020	4365
		Metal Frame	2534	2729	2825	2885	2981	3086	3185	3284	3377	3488	3941	4286
4945-AO-U M4945-AO-U (METAL FRAME) 	Tandem Bariatric Add-On Unit 40" Wide, Black Urethane Arm Cap W 38 D 25 ³ / ₄ H 34 Seat Height 18 Inside Seat Width 36 Inside Seat Depth 18 Arm Height 26 ¹ / ₂ 3 yds. 71 lbs. COL 60 sq. ft.	Wood Frame	2296	2491	2587	2647	2743	2848	2947	3046	3139	3250	3703	4048
		Metal Frame	2228	2423	2519	2579	2675	2780	2879	2978	3071	3182	3635	3980
4945-EU-U M4945-EU-U (METAL FRAME) 	Tandem Bariatric End Unit 40" Wide, Black Urethane Arm Cap W 38 ¹ / ₂ D 25 ³ / ₄ H 34 Seat Height 18 Inside Seat Width 36 Inside Seat Depth 18 Arm Height 26 ¹ / ₂ 3 yds. 71 lbs. COL 60 sq. ft.	Wood Frame	2296	2491	2587	2647	2743	2848	2947	3046	3139	3250	3703	4048
		Metal Frame	2228	2423	2519	2579	2675	2780	2879	2978	3071	3182	3635	3980
-PA	Upholstered Inset Panel Arm (wood or metal frame, per arm) 1/2 yd. COL 10 sq. ft.		150	183	199	209	225	242	259	275	291	309	385	442
	Connecting Tables Page 6 Tandem Seating Pages 7-10 Inline Benches Page 11													

OPTIONS		
-PFW04	Premium Wood Finish, Frame	34
-SC02	Replaceable Seat Cover (per seat)	84
-BC02	Replaceable Back Cover (per back)	64
-MB02	Moisture Barrier (seat only, per seat)	133
-NS02	Non-Skid Glides (per arm frame)	15

HAVEN GUEST + TANDEM // DESIGNED BY DAVID DAHL

CONFIGURATION EXAMPLES:

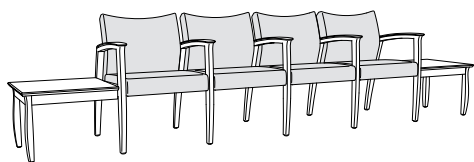

Qty	Model #	Description	COM List
2	4918-22	22" Wide End Table (\$1,192 List each)	\$2,384
1	4920-ST-W	Tandem Starter Unit, Wood Arm Caps	\$1,842
2	4920-AO-W	Tandem Add-On Unit, Wood Arm Cap (\$1,512 List each)	\$3,024
1	4920-EU-W	Tandem End Unit, Wood Arm Cap	\$1,512
6			\$8,762

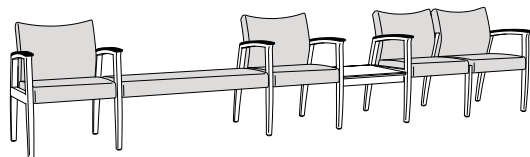

Qty	Model #	Description	COM List
1	4920-ST-U	Tandem Starter Unit, Urethane Arm Caps	\$1,842
1	4928-AO-U	42" Wide Inline Bench, Urethane Arm Cap	\$1,412
1	4920-EU-U	Tandem End Unit, Urethane Arm Cap	\$1,512
1	4917-22	22" Center Table	\$1,062
1	4925-ST-U	Tandem Starter Unit, Urethane Arm Cap/Armless	\$1,667
1	4925-EU-U	Tandem End Unit, Armless/Urethane Arm Cap	\$1,667
6			\$9,162

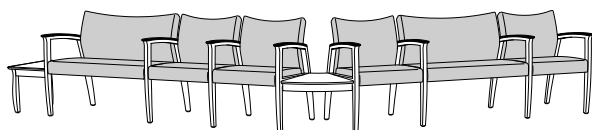



Qty	Model #	Description	COM List
1	M4918-15	15" Wide End Table	\$1,063
1	M4945-ST-U	Tandem 40" W Bariatric Starter Unit, Urethane Arm Caps	\$2,534
1	M4920-AO-U	Tandem Add-On Unit, Urethane Arm Cap	\$1,441
2	M4920-EU-U	Tandem End Units, Urethane Arm Cap (\$1,441 List each)	\$2,882
1	M4919-45	45-Degree Corner Table	\$1,095
1	M4920-ST-U	Tandem Starter Unit, Urethane Arm Cap	\$1,719
1	M4945-AO-U	Tandem 40" W Bariatric Add-On Unit, Urethane Arm Cap	\$2,228
8			\$12,962

HAVEN GUEST + TANDEM // DESIGNED BY DAVID DAHL

ORDERING REQUIREMENTS:

- » Model number
- » Upholstery selection
- » Frame finish
- » Options, as applicable
- » Arm cap finish, as applicable

Note: For Corian arm caps, specify '-CO' in place of '-W' after model number and refer to options below for upcharge.

MODEL NUMBER	PRODUCT SPECIFICATIONS	FABRIC GRADES										LEATHER		
		COM	A	1	2	COL					L1	L2		
4950-W M4950-W (METAL FRAME) 	Patient Chair Wood Arm Caps W 25 D 25 ³ / ₄ H 44 Seat Height 18 Inside Seat Width 21 Inside Seat Depth 19 Arm Height 26 ¹ / ₂ 2 yds. 41 lbs. COL 40 sq. ft.	Wood Frame	2000	2130	2194	2234	2298	2368	2434	2500	2562	2636	2938	3168
		Metal Frame	1922	2052	2116	2156	2220	2290	2356	2422	2484	2558	2860	3090
4950-U M4950-U (METAL FRAME) 	Patient Chair Black Urethane Arm Caps W 25 D 25 ³ / ₄ H 44 Seat Height 18 Inside Seat Width 21 Inside Seat Depth 19 Arm Height 26 ¹ / ₂ 2 yds. 41 lbs. COL 40 sq. ft.	Wood Frame	2000	2130	2194	2234	2298	2368	2434	2500	2562	2636	2938	3168
		Metal Frame	1922	2052	2116	2156	2220	2290	2356	2422	2484	2558	2860	3090
-PA	Upholstered Inset Panel Arm (wood or metal frame, per arm) 1/2 yd. COL 10 sq. ft.		150	183	199	209	225	242	259	275	291	309	385	442

OPTIONS



-PFW01	Premium Wood Finish, Arm Cap (per arm)	12
-PFW04	Premium Wood Finish, Frame	34
-CO01	Corian Arm Cap (per arm)	84
-SC01	Replaceable Seat Cover	64
-BC01	Replaceable Back Cover	42
-MB01	Moisture Barrier (seat only)	69
-NS04	Non-Skid Glides	29

HAVEN GUEST + TANDEM // DESIGNED BY DAVID DAHL

ORDERING REQUIREMENTS:

- » Model number » Upholstery selection
- » Frame finish » Options, as applicable
- » Arm cap finish, as applicable

Note: For Corian arm caps, specify '-CO' in place of '-W' after model number and refer to options below for upcharge.

MODEL NUMBER	PRODUCT SPECIFICATIONS	FABRIC GRADES										LEATHER				
		COM	A	1	2	COL					3	4	5	6	7	8
4957-W M4957-W (METAL FRAME)	 <p>Easy Access/Hip Chair, Open Arm Wood Arm Caps W 25 D 25³/₄ H 40 Seat Height 24¹/₂ Inside Seat Width 21 Inside Seat Depth 18¹/₂ Arm Height 32³/₄ 1³/₄ yds. 45 lbs. COL 35 sq. ft.</p>	Wood Frame	2369	2483	2539	2574	2630	2691	2749	2807	2861	2926	3190	3391		
		Metal Frame	2298	2412	2468	2503	2559	2620	2678	2736	2790	2855	3119	3320		
4957-U M4957-U (METAL FRAME)	 <p>Easy Access/Hip Chair, Open Arm Black Urethane Arm Caps W 25 D 25³/₄ H 40 Seat Height 24¹/₂ Inside Seat Width 21 Inside Seat Depth 18¹/₂ Arm Height 32³/₄ 1³/₄ yds. 45 lbs. COL 35 sq. ft.</p>	Wood Frame	2369	2483	2539	2574	2630	2691	2749	2807	2861	2926	3190	3391		
		Metal Frame	2298	2412	2468	2503	2559	2620	2678	2736	2790	2855	3119	3320		
-PA	<p>Upholstered Inset Panel Arm (wood or metal frame, per arm) 1/2 yd. COL 10 sq. ft.</p>		150	183	199	209	225	242	259	275	291	309	385	442		



OPTIONS

-PFW01	Premium Wood Finish, Arm Cap (per arm)	12
-PFW04	Premium Wood Finish, Frame	34
-CO01	Corian Arm Cap (per arm)	84
-SC01	Replaceable Seat Cover	64
-BC01	Replaceable Back Cover	42
-MB01	Moisture Barrier (seat only)	69
-NS04	Non-Skid Glides	29

HAVEN GUEST + TANDEM // DESIGNED BY DAVID DAHL

PRODUCT FEATURES:





- » Concealed velcro attachment.
- » Replacement seat and back covers can be easily field installed on previously ordered Haven models with replaceable cover option.
- » Haven models originally ordered with standard fixed upholstery can utilize replacement seat and/or back covers, however some upholstery work will be required to remove original upholstery covers.

MODEL NUMBER	PRODUCT SPECIFICATIONS	FABRIC GRADES										LEATHER	
		COM	A	1	2	COL		3	4	5	6	7	8
RSC-4910 	Replacement Upholstered Seat Cover 3/4 yd. COL 15 sq. ft. Applies to: 4910/M4910 Guest, Arm 4910/M4910 Tandem 4915/M4915 Guest, Armless 4920/M4920 Tandem 4925/M4925 Tandem 4930/M4930 Tandem 4935/M4935 Tandem 4950/M4950 Patient Chair 4957/M4957 Easy Access/Hip Chair	165	214	238	253	277	303	328	353	376	404	517	603
RBC-4910 	Replacement Upholstered Back Cover 1 1/4 yds. COL 25 sq. ft. Applies to: 4910/M4910 Guest, Arm 4910/M4910 Tandem 4915/M4915 Guest, Armless 4920/M4920 Tandem 4925/M4925 Tandem 4930/M4930 Tandem 4935/M4935 Tandem 4957/M4957 Easy Access/Hip Chair	187	269	309	334	374	417	459	500	539	585	774	917
OPTIONS													
-MB01	Moisture Barrier (seat only)	69											

HAVEN GUEST + TANDEM // DESIGNED BY DAVID DAHL

PRODUCT FEATURES:

- » Concealed velcro attachment.
- » Replacement seat and back covers can be easily field installed on previously ordered Haven models with replaceable cover option.
- » Haven models originally ordered with standard fixed upholstery can utilize replacement seat and/or back covers, however some upholstery work will be required to remove original upholstery covers.

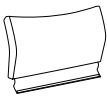
MODEL NUMBER	PRODUCT SPECIFICATIONS	FABRIC GRADES										LEATHER	
		COM	A	1	2	COL		3	4	5	6	7	8
RSC-4927 	21" Wide Inline Bench Replacement Upholstered Seat Cover 1 yd. COL 20 sq. ft.	165	230	262	282	314	349	382	415	446	483	634	749
RSC-4928 	42" Wide Inline Bench Replacement Upholstered Seat Cover 1 1/2 yds. COL 30 sq. ft.	187	285	333	363	411	463	513	562	609	664	891	1063
RSC-4940 	34" Wide Bariatric Settee Replacement Upholstered Seat Cover 1 1/4 yds. COL 25 sq. ft.	256	338	378	403	443	486	528	569	608	654	843	986
RBC-4940 	34" Wide Bariatric Settee Replacement Upholstered Back Cover 1 3/4 yds. COL 35 sq. ft.	256	370	426	461	517	578	636	694	748	813	1077	1278
RSC-4945 	40" Wide Bariatric Settee Replacement Upholstered Seat Cover 1 1/2 yds. COL 30 sq. ft.	256	354	402	432	480	532	582	631	678	733	960	1132
RBC-4945 	40" Wide Bariatric Settee Replacement Upholstered Back Cover 1 3/4 yds. COL 35 sq. ft.	256	370	426	461	517	578	636	694	748	813	1077	1278







OPTIONS

-MB01	Moisture Barrier (RSC-4927 only)	69
-MB02	Moisture Barrier (RSC-4928, RSC-4940 and RSC-4945)	133

HAVEN GUEST + TANDEM // DESIGNED BY DAVID DAHL

PRODUCT FEATURES:

- » Replacement hardware included with replacement frames.

MODEL NUMBER	PRODUCT SPECIFICATIONS	LIST
<p>4910-05R (WOOD RIGHT ARM, AS SEATED) 4910-05C (WOOD CENTER ARM, AS SEATED) 4910-05L (WOOD LEFT ARM, AS SEATED)</p> 	<p>Replacement Guest Chair Wood Frame, No Arm Cap 9 lbs.</p>	304
<p>4915-05R (WOOD RIGHT ARM, AS SEATED) 4915-05C (WOOD CENTER ARM, AS SEATED) 4915-05L (WOOD LEFT ARM, AS SEATED)</p> 	<p>Replacement Guest Chair Wood Frame, Armless, Center 7 lbs.</p>	280
<p>M4910-05R (METAL RIGHT ARM, AS SEATED) M4910-05C (METAL CENTER ARM, AS SEATED) M4910-05L (METAL LEFT ARM, AS SEATED)</p> 	<p>Replacement Guest Chair Metal Frame, No Arm Cap 9 lbs.</p>	297
<p>M4915-05R (METAL RIGHT ARM, AS SEATED) M4915-05C (METAL CENTER ARM, AS SEATED) M4915-05L (METAL LEFT ARM, AS SEATED)</p> 	<p>Replacement Guest Chair Metal Frame, Armless, Center 7 lbs.</p>	268
<p>4910-07W (WOOD)</p> 	<p>Replacement Wood Arm Cap 2 lbs.</p>	119
<p>4910-07U (URETHANE)</p> 	<p>Replacement Black Urethane Arm Cap 2 lbs.</p>	119
<p>4910-07C (CORIAN)</p> 	<p>Replacement Corian Arm Cap (standard colors only) 2 lbs.</p>	241

OPTIONS

-PFW01	Premium Wood Finish, Arm Cap (per arm)	12
-PFW04	Premium Wood Finish, Frame	34

HAVEN GUEST + TANDEM // DESIGNED BY DAVID DAHL

UPHOLSTERY COMBINATIONS:

- » When combining two COM/COV/COL fabrics, or fabrics with the same grade, add \$120 List per unit.
- » When combining three COM/COV/COL fabrics, or fabrics with the same grade, add \$150 List per unit.
- » When combining different grades of fabric, price will be based on the highest grade specified.
- » Two-tone upholstery examples and yardage requirements for the most common combinations are listed below. Additional combinations available, please contact client services for yardage requirements and pricing.
- » Note: Yardage amounts are based on fabric which is plain (i.e. non-directional) and a full 54" wide.
- » Appropriate upholstery code must be included.



Code	HA1
<u>Models</u>	<u>COM Requirement</u>
All Guest & Easy Access/Hip Units	Seat = $\frac{3}{4}$ yd. Back = $1\frac{1}{4}$ yds.



Code	HA2
<u>Models</u>	<u>COM Requirement</u>
All 34" W Bariatric Units	Seat = $1\frac{1}{4}$ yds. Back = $1\frac{3}{4}$ yds.

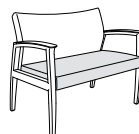

Code	HA3
<u>Models</u>	<u>COM Requirement</u>
All 40" W Bariatric Units	Seat = $1\frac{1}{2}$ yds. Back = $1\frac{3}{4}$ yds.



Code	HA4
<u>Models</u>	<u>COM Requirement</u>
4950-W 4950-U	Seat = $\frac{3}{4}$ yd. Back = 2 yds.

HAVEN LOUNGE SEATING



arcadia

MARCH 1, 2026
VA IDIQ CONTRACT (FY26)
(DEALER HELD)

HAVEN LOUNGE // DESIGNED BY DAVID DAHL



PRODUCT FEATURES:



ARM CAP:

- Radiused edges for smooth surface contact.
- Finger-grip design for added stability.
- Generously proportioned to provide greater support.
- Field-replaceable arm caps featured on all open arm models only.



FLEX BACK:

- Featured on all lounge models (love seats and sofas not applicable).
- Passive flex back motion provides long-term seated comfort.



CLEAN-OUT PORTAL:

- Featured on all models including love seat and sofa.
- Clean-out area between seat and back enables crumbs and debris to fall through for maintenance ease.



METAL SEAT FRAME:

- Metal seat frame construction ensures durability and allows in-field component replacement as well as add-on capability for tandem units.



OPTIONAL REPLACEABLE UPHOLSTERY:

- Replaceable seat cover available on all models.
- Replaceable back cover available on all lounge models (love seats and sofas not applicable).

HAVEN LOUNGE // DESIGNED BY DAVID DAHL

PRODUCT FEATURES CONTINUED:

- » Four arm options: open arm, inset panel arm, upholstered arm or fully upholstered.
- » Open arm, inset panel arm and upholstered arm models available in three arm cap options: beech wood, black urethane or Corian.
- » All models feature wood or metal frame with 6" height clearance for floor maintenance ease.
- » Wall-saver leg design.
- » Optional silver casters available on panel arm and fully upholstered lounge models only, at no upcharge. Black casters also available, please specify.
- » Please note that when casters are specified, wall-saver capability no longer applies.
- » Optional pull available on back of lounge chair with casters only. Satin nickel finish.
- » Maximum weight capacity is 400 lbs. for lounge chairs, 700 lbs. for love seats and 900 lbs. for sofas.
- » All dimensions are nominal.

ROTATING TABLET:

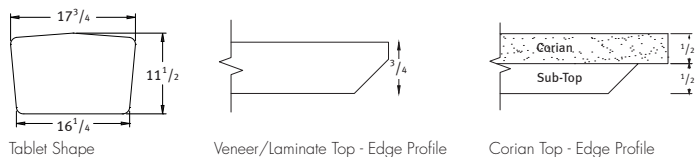

- » Available on select upholstered arm options and fully upholstered models only.
- » Tablet size is 17³/₄" W x 11¹/₂" D x 3³/₄" thick with 360-degree turning radius.
- » Three tablet surface options: beech veneer, laminate or Corian.
- » For maximum durability, a laminate or Corian surface with a clear coat edge finish is recommended.
- » Refer to Terms and Conditions for edge finish details.

CUP HOLDER:

- » Dimensions: 5" diameter.
- » Cup holder will be mounted to right side, as seated, unless otherwise specified.
- » If specified in conjunction with a tablet, cup holder will be mounted to opposite side, unless otherwise specified.
- » Cup holder finish is 0299 Polished Aluminum, with black laminate insert.

POWER UNITS:

- » Unit affixed to right side of seating units, as seated, unless otherwise specified.
- » If specified in conjunction with a tablet, power unit will be mounted to same side as tablet unless otherwise specified.
- » Black or white finish with 120" electrical cord (no hardwire option available for this series).
- » Power units not available on units with casters.
- » UL listed.



PX1
5¹/₄" W x 2¹/₂" D
One outlet, one USB-A and one USB-C charging port



PX2
6⁵/₈" W x 2¹/₂" D
Two outlets, one USB-A and one USB-C charging port

HAVEN LOUNGE // DESIGNED BY DAVID DAHL

SPECIFICATIONS:

- » Wood frame, arm caps and tablet available in all standard and custom finishes on beech.
- » For Super Matte Sable Beech, premium wood finish upcharge applies. Refer to options section for pricing.
- » For custom wood finishes to frame, arm caps, legs and/or tablet, please add one-time upcharge of \$514 List per color per order.
- » For custom laminates (tablet only), add \$642 List per color per order. Pre-approval required, please contact client services.
- » Metal frame available in two finishes. For non-standard options, please contact client services.

CORIAN® COLORS:

- » CWN Designer White
- » CLN Linen
- » CTD Witch Hazel
- » CRC Rain Cloud
- » CGQ Grey Onyx
- » CSQ Stonique

METAL FRAME FINISHES:

- » 0405 Charcoal Grey
- » 0535 Metallic Silver

ORDERING REQUIREMENTS:

- » Model number
- » Frame finish
- » Arm cap finish
- » Upholstery selection
- » Options, as applicable

HAVEN LOUNGE // DESIGNED BY DAVID DAHL

ORDERING REQUIREMENTS:

- » Model number
- » Upholstery selection
- » Frame finish
- » Options, as applicable
- » Arm cap finish

Note: For Corian arm caps, specify '-CO' in place of '-W' after model number and refer to options below for upcharge.

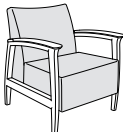
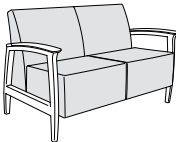
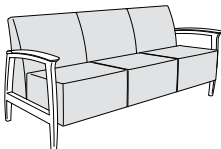
MODEL NUMBER	PRODUCT SPECIFICATIONS	FABRIC GRADES										LEATHER				
		COM	A	1	2	COL					3	4	5	6	7	8
4961-W M4961-W (METAL FRAME) 	Lounge Chair, Open Arm Wood Arm Caps W 28 D 30 ¹ / ₂ H 34 ¹ / ₂ Seat Height 18 Inside Seat Width 23 Inside Seat Depth 18 ¹ / ₂ Arm Height 25 ³ / ₄ 3 yds. 59 lbs. COL 60 sq. ft.	Wood Frame	2649	2844	2940	3000	3096	3201	3300	3399	3492	3603	4056	4401		
		Metal Frame	2570	2765	2861	2921	3017	3122	3221	3320	3413	3524	3977	4322		
4962-W M4962-W (METAL FRAME) 	Love Seat, Open Arm Wood Arm Caps W 51 ¹ / ₄ D 30 ¹ / ₂ H 34 ¹ / ₂ Seat Height 18 Inside Seat Width 46 Inside Seat Depth 18 ¹ / ₂ Arm Height 25 ³ / ₄ 5 yds. 81 lbs. COL 100 sq. ft.	Wood Frame	3353	3678	3838	3938	4098	4273	4438	4603	4758	4943	5698	6273		
		Metal Frame	3256	3581	3741	3841	4001	4176	4341	4506	4661	4846	5601	6176		
4963-W M4963-W (METAL FRAME) 	Sofa, Open Arm Wood Arm Caps W 75 ¹ / ₄ D 30 ¹ / ₂ H 34 ¹ / ₂ Seat Height 18 Inside Seat Width 69 Inside Seat Depth 18 ¹ / ₂ Arm Height 25 ³ / ₄ 7 yds. 119 lbs. COL 140 sq. ft.	Wood Frame	4239	4694	4918	5058	5282	5527	5758	5989	6206	6465	7522	8327		
		Metal Frame	4114	4569	4793	4933	5157	5402	5633	5864	6081	6340	7397	8202		
-PA	Upholstered Inset Panel Arm (wood or metal frame, per arm) 1 ¹ / ₂ yds. COL 30 sq. ft.		245	343	391	421	469	521	571	620	667	722	949	1121		

OPTIONS		
-PFW01	Premium Wood Finish, Arm Cap (per arm)	12
-PFW03	Premium Wood Finish, Frame	34
-CO05	Corian Arm Cap (per arm)	232
-SC02	Replaceable Seat Cover (all models, per seat)	84
-BC02	Replaceable Back Cover (lounge model only)	64
-MB02	Moisture Barrier, Lounge (seat only)	133
-MB03	Moisture Barrier, Love Seat (seat only)	201
-MB05	Moisture Barrier, Sofa (seat only)	297
-NS04	Non-Skid Glides	29

HAVEN LOUNGE // DESIGNED BY DAVID DAHL

ORDERING REQUIREMENTS:

- » Model number
- » Frame finish
- » Upholstery selection
- » Options, as applicable

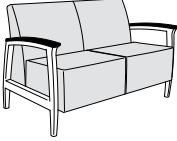
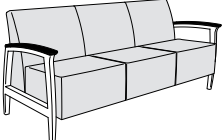
MODEL NUMBER	PRODUCT SPECIFICATIONS	FABRIC GRADES										LEATHER		
		COM	A	1	2	COL					L1	L2		
4961-U M4961-U (METAL FRAME) 	Lounge Chair, Open Arm Black Urethane Arm Caps W 28 D 30 ¹ / ₂ H 34 ¹ / ₂ Seat Height 18 Inside Seat Width 23 Inside Seat Depth 18 ¹ / ₂ Arm Height 25 ³ / ₄ 3 yds. 59 lbs. COL 60 sq. ft.	Wood Frame	2649	2844	2940	3000	3096	3201	3300	3399	3492	3603	4056	4401
		Metal Frame	2570	2765	2861	2921	3017	3122	3221	3320	3413	3524	3977	4322
4962-U M4962-U (METAL FRAME) 	Love Seat, Open Arm Black Urethane Arm Caps W 51 ¹ / ₄ D 30 ¹ / ₂ H 34 ¹ / ₂ Seat Height 18 Inside Seat Width 46 Inside Seat Depth 18 ¹ / ₂ Arm Height 25 ³ / ₄ 5 yds. 81 lbs. COL 100 sq. ft.	Wood Frame	3353	3678	3838	3938	4098	4273	4438	4603	4758	4943	5698	6273
		Metal Frame	3256	3581	3741	3841	4001	4176	4341	4506	4661	4846	5601	6176
4963-U M4963-U (METAL FRAME) 	Sofa, Open Arm Black Urethane Arm Caps W 75 ¹ / ₄ D 30 ¹ / ₂ H 34 ¹ / ₂ Seat Height 18 Inside Seat Width 69 Inside Seat Depth 18 ¹ / ₂ Arm Height 25 ³ / ₄ 7 yds. 119 lbs. COL 140 sq. ft.	Wood Frame	4239	4694	4918	5058	5282	5527	5758	5989	6206	6465	7522	8327
		Metal Frame	4114	4569	4793	4933	5157	5402	5633	5864	6081	6340	7397	8202
-PA	Upholstered Inset Panel Arm (wood or metal frame, per arm) 1 ¹ / ₂ yds. COL 30 sq. ft.		245	343	391	421	469	521	571	620	667	722	949	1121

OPTIONS		
-PFW01	Premium Wood Finish, Arm Cap (per arm)	12
-PFW03	Premium Wood Finish, Frame	34
-CO05	Corian Arm Cap (per arm)	232
-SC02	Replaceable Seat Cover (all models, per seat)	84
-BC02	Replaceable Back Cover (lounge model only)	64
-MB02	Moisture Barrier, Lounge (seat only)	133
-MB03	Moisture Barrier, Love Seat (seat only)	201
-MB05	Moisture Barrier, Sofa (seat only)	297
-NS04	Non-Skid Glides	29

HAVEN LOUNGE // DESIGNED BY DAVID DAHL

ORDERING REQUIREMENTS:

- » Model number
- » Leg finish
- » Upholstery selection
- » Options, as applicable

Note: Panel arm thickness with urethane arm caps is 1" less than with wood or Corian arm caps.

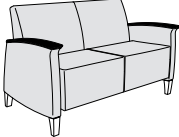
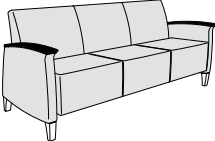
MODEL NUMBER	PRODUCT SPECIFICATIONS	FABRIC GRADES										LEATHER		
		COM	A	1	2	COL		3	4	5	6	7	8	L1
4965-U M4965-U (METAL LEGS) 	Lounge Chair, Upholstered Arm Black Urethane Arm Caps W 27 ¹ / ₂ D 30 ¹ / ₂ H 34 ¹ / ₂ Seat Height 18 Inside Seat Width 23 Inside Seat Depth 18 ¹ / ₂ Arm Height 25 ³ / ₄ 5 ¹ / ₂ yds. 84 lbs. COL 110 sq. ft.	Wood Legs	2726	3084	3260	3370	3546	3738	3920	4101	4272	4475	5306	5938
		Metal Legs	2450	2808	2984	3094	3270	3462	3644	3825	3996	4199	5030	5662
4966-U M4966-U (METAL LEGS) 	Love Seat, Upholstered Arm Black Urethane Arm Caps W 51 ¹ / ₄ D 30 ¹ / ₂ H 34 ¹ / ₂ Seat Height 18 Inside Seat Width 47 Inside Seat Depth 18 ¹ / ₂ Arm Height 25 ³ / ₄ 7 ¹ / ₂ yds. 118 lbs. COL 150 sq. ft.	Wood Legs	3403	3891	4131	4281	4521	4783	5031	5278	5511	5788	6921	7783
		Metal Legs	3144	3632	3872	4022	4262	4524	4772	5019	5252	5529	6662	7524
4967-U M4967-U (METAL LEGS) 	Sofa, Upholstered Arm Black Urethane Arm Caps W 74 ³ / ₄ D 30 ¹ / ₂ H 34 ¹ / ₂ Seat Height 18 Inside Seat Width 70 ¹ / ₂ Inside Seat Depth 18 ¹ / ₂ Arm Height 25 ³ / ₄ 9 ¹ / ₂ yds. 150 lbs. COL 190 sq. ft.	Wood Legs	4827	5445	5749	5939	6243	6575	6889	7202	7497	7848	9283	10375
		Metal Legs	4463	5081	5385	5575	5879	6211	6525	6838	7133	7484	8919	10011

OPTIONS		
-PFW01	Premium Wood Finish, Legs	12
-SC02	Replaceable Seat Cover (all models, per seat)	84
-BC02	Replaceable Back Cover (lounge model only)	64
-MB02	Moisture Barrier, Lounge (seat only)	133
-MB03	Moisture Barrier, Love Seat (seat only)	201
-MB05	Moisture Barrier, Sofa (seat only)	297
-NS04	Non-Skid Glides	29
-C02	Casters (lounge model only)	67
-P01	Pull (lounge model only, when specified with casters)	69
-PX1(-)	Power Matrix 1 (one power, one USB-A, one USB-C)	514
-PX2(-)	Power Matrix 2 (dual power, one USB-A, one USB-C)	538

HAVEN LOUNGE // DESIGNED BY DAVID DAHL

ORDERING REQUIREMENTS:

- » Model number » Upholstery selection
- » Frame finish » Options, as applicable
- » Arm cap finish

Note: For Corian arm caps, specify '-CO' in place of '-W' after model number and refer to options below for upcharge.

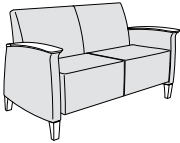
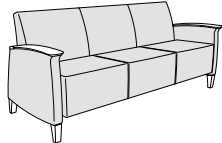
MODEL NUMBER	PRODUCT SPECIFICATIONS	FABRIC GRADES										LEATHER				
		COM	A	1	2	COL			3	4	5	6	7	8	L1	L2
4971-W M4971-W (METAL LEGS) 	Lounge Chair, Upholstered Arm Wood Arm Caps W 29 ¹ / ₂ D 30 ¹ / ₂ H 34 ¹ / ₂ Seat Height 18 Inside Seat Width 23 Inside Seat Depth 18 ¹ / ₂ Arm Height 25 ³ / ₄ 5 ¹ / ₂ yds. 84 lbs. COL 110 sq. ft.	Wood Frame	2651	3009	3185	3295	3471	3663	3845	4026	4197	4400	5231	5863		
		Metal Frame	2572	2930	3106	3216	3392	3584	3766	3947	4118	4321	5152	5784		
4972-W M4972-W (METAL LEGS) 	Love Seat, Upholstered Arm Wood Arm Caps W 53 ¹ / ₄ D 30 ¹ / ₂ H 34 ¹ / ₂ Seat Height 18 Inside Seat Width 47 Inside Seat Depth 18 ¹ / ₂ Arm Height 25 ³ / ₄ 7 ¹ / ₂ yds. 118 lbs. COL 150 sq. ft.	Wood Frame	3403	3891	4131	4281	4521	4783	5031	5278	5511	5788	6921	7783		
		Metal Frame	3302	3790	4030	4180	4420	4682	4930	5177	5410	5687	6820	7682		
4973-W M4973-W (METAL LEGS) 	Sofa, Upholstered Arm Wood Arm Caps W 76 ³ / ₄ D 30 ¹ / ₂ H 34 ¹ / ₂ Seat Height 18 Inside Seat Width 70 ¹ / ₂ Inside Seat Depth 18 ¹ / ₂ Arm Height 25 ³ / ₄ 9 ¹ / ₂ yds. 150 lbs. COL 190 sq. ft.	Wood Frame	4597	5215	5519	5709	6013	6345	6659	6972	7267	7618	9053	10145		
		Metal Frame	4463	5081	5385	5575	5879	6211	6525	6838	7133	7484	8919	10011		

OPTIONS		
-PFW01	Premium Wood Finish, Arm Cap (per arm)	12
-PFW02	Premium Wood Finish, Rotating Tablet	22
-PFW03	Premium Wood Finish, Frame	34
-CO05	Corian Arm Cap (per arm)	232
-SC02	Replaceable Seat Cover (all models, per seat)	84
-BC02	Replaceable Back Cover (lounge model only, per back)	64
-MB02	Moisture Barrier, Lounge (seat only)	133
-MB03	Moisture Barrier, Love Seat (seat only)	201
-MB05	Moisture Barrier, Sofa (seat only)	297
-NS04	Non-Skid Glides (per chair)	29
-C02	Casters (lounge model only)	67
-CHR02	Cup Holder (polished aluminum)	263
-P01	Pull (lounge model only, when specified with casters)	69
-TAR08	Veneer/Laminate Rotating Tablet, Right (as seated)	531
-TAL08	Veneer/Laminate Rotating Tablet, Left (as seated)	531
-TAR08-CO	Corian Rotating Tablet, Right (as seated)	896
-TAL08-CO	Corian Rotating Tablet, Left (as seated)	896
-PX1(-)	Power Matrix 1 (one power, one USB-A, one USB-C)	514
-PX2(-)	Power Matrix 2 (dual power, one USB-A, one USB-C)	538

Note: for power matrix faceplate, please specify black (-B) or white (-W) finish.

HAVEN LOUNGE // DESIGNED BY DAVID DAHL

ORDERING REQUIREMENTS:

- » Model number
- » Leg finish
- » Upholstery selection
- » Options, as applicable

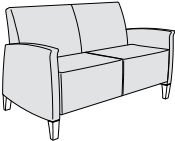
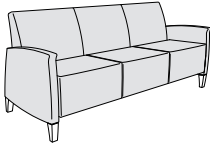
MODEL NUMBER	PRODUCT SPECIFICATIONS	FABRIC GRADES										LEATHER		
		COM	A	1	2	COL					L1	L2		
4975 M4975 (METAL LEGS) 	Lounge Chair, Fully Upholstered W 28 ¹ / ₂ D 30 ¹ / ₂ H 34 ¹ / ₂ Seat Height 18 Inside Seat Width 23 Inside Seat Depth 18 ¹ / ₂ Arm Height 25 ³ / ₄ 5 ³ / ₄ yds. 84 lbs. COL 115 sq. ft.	Wood Legs	2510	2884	3068	3183	3367	3568	3758	3948	4126	4339	5207	5868
		Metal Legs	2437	2811	2995	3110	3294	3495	3685	3875	4053	4266	5134	5795
4976 M4976 (METAL LEGS) 	Love Seat, Fully Upholstered W 52 ¹ / ₄ D 30 ¹ / ₂ H 34 ¹ / ₂ Seat Height 18 Inside Seat Width 47 Inside Seat Depth 18 ¹ / ₂ Arm Height 25 ³ / ₄ 7 ³ / ₄ yds. 118 lbs. COL 155 sq. ft.	Wood Legs	3190	3694	3942	4097	4345	4616	4872	5128	5368	5655	6825	7716
		Metal Legs	3095	3599	3847	4002	4250	4521	4777	5033	5273	5560	6730	7621
4977 M4977 (METAL LEGS) 	Sofa, Fully Upholstered W 75 ³ / ₄ D 30 ¹ / ₂ H 34 ¹ / ₂ Seat Height 18 Inside Seat Width 70 ¹ / ₂ Inside Seat Depth 18 ¹ / ₂ Arm Height 25 ³ / ₄ 9 ³ / ₄ yds. 150 lbs. COL 195 sq. ft.	Wood Legs	4141	4775	5087	5282	5594	5935	6257	6579	6881	7242	8714	9835
		Metal Legs	4018	4652	4964	5159	5471	5812	6134	6456	6758	7119	8591	9712



OPTIONS

-PFW01	Premium Wood Finish, Legs	12
-PFW02	Premium Wood Finish, Rotating Tablet	22
-CO05	Corian Arm Cap (per arm)	232
-SC02	Replaceable Seat Cover (all models, per seat)	84
-BC02	Replaceable Back Cover (lounge model only, per back)	64
-MB02	Moisture Barrier, Lounge (seat only)	133
-MB03	Moisture Barrier, Love Seat (seat only)	201
-MB05	Moisture Barrier, Sofa (seat only)	297
-NS04	Non-Skid Glides (per chair)	29
-C02	Casters (lounge model only)	67
-CHR02	Cup Holder (polished aluminum)	263
-P01	Pull (lounge model only, when specified with casters)	69
-TAR08	Veneer/Laminate Rotating Tablet, Right (as seated)	531
-TAL08	Veneer/Laminate Rotating Tablet, Left (as seated)	531
-TAR08-CO	Corian Rotating Tablet, Right (as seated)	896
-TAL08-CO	Corian Rotating Tablet, Left (as seated)	896
-PX1(-)	Power Matrix 1 (one power, one USB-A, one USB-C)	514
-PX2(-)	Power Matrix 2 (dual power, one USB-A, one USB-C)	538

HAVEN LOUNGE // DESIGNED BY DAVID DAHL

ORDERING REQUIREMENTS:









- » Model number
- » Upholstery selection

MODEL NUMBER	PRODUCT SPECIFICATIONS	FABRIC GRADES										LEATHER	
		COM	A	1	2	COL		3	4	5	6	7	8
RSC-4961 	Lounge Replacement Upholstered Seat Cover 1 ¹ / ₄ yds. COL 25 sq. ft. Applies to: 4961/M4961 Lounge 4965/M4965 Lounge 4971/M4971 Lounge 4975/M4975 Lounge	274	356	396	421	461	504	546	587	626	672	861	1004
RBC-4961 	Lounge Replacement Upholstered Back Cover 1 ³ / ₄ yds. COL 35 sq. ft. Applies to: 4961/M4961 Lounge 4965/M4965 Lounge 4971/M4971 Lounge 4975/M4975 Lounge	274	388	444	479	535	596	654	712	766	831	1095	1296

HAVEN LOUNGE // DESIGNED BY DAVID DAHL

ORDERING REQUIREMENTS:

- » Model number
- » Frame finish
- » Arm cap finish, as applicable

MODEL NUMBER	PRODUCT SPECIFICATIONS	LIST
<p>4961-05R (WOOD RIGHT ARM, AS SEATED) 4961-05C (WOOD CENTER ARM, AS SEATED) 4961-05L (WOOD LEFT ARM, AS SEATED)</p> 	<p>Open Arm Models - Replacement Wood Frame No Arm Cap 11 lbs.</p>	<p>387</p>
<p>M4961-05R (METAL RIGHT ARM, AS SEATED) M4961-05C (METAL CENTER ARM, AS SEATED) M4961-05L (METAL LEFT ARM, AS SEATED)</p> 	<p>Open Arm Models - Replacement Metal Frame No Arm Cap 11 lbs.</p>	<p>384</p>
<p>4961-07W (WOOD)</p> 	<p>Open Arm Models - Replacement Wood Arm Cap 2 lbs.</p>	<p>135</p>
<p>4961-07U (URETHANE)</p> 	<p>Open Arm Models - Replacement Black Urethane Arm Cap 2 lbs.</p>	<p>135</p>
<p>4961-07C (CORIAN)</p> 	<p>Open Arm Models - Corian Replacement Arm Cap (standard colors only) 2 lbs.</p>	<p>299</p>
<p>4965-07U (URETHANE)</p> 	<p>Upholstered Arm Models - Replacement Black Urethane Arm Cap (specific to models on page 6) 2 lbs.</p>	<p>135</p>
<p>4971-07W (WOOD)</p> 	<p>Upholstered Arm Models - Replacement Wood Arm Cap 2 lbs.</p>	<p>135</p>
<p>4971-07C (CORIAN)</p> 	<p>Upholstered Arm Models - Replacement Corian Arm Cap (standard colors only) 2 lbs.</p>	<p>299</p>

HAVEN LOUNGE // DESIGNED BY DAVID DAHL

UPHOLSTERY COMBINATIONS:

- » When combining two COM/COV/COL fabrics, or fabrics with the same grade, add \$120 List per unit.
- » When combining three COM/COV/COL fabrics, or fabrics with the same grade, add \$150 List per unit.
- » When combining different grades of fabric, price will be based on the highest grade specified.
- » Two-tone upholstery examples and yardage requirements for the most common combinations are listed below. Additional combinations available, please contact client services for yardage requirements and pricing.
- » Note: Yardage amounts are based on fabric which is plain (i.e. non-directional) and a full 54" wide.
- » Appropriate upholstery code must be included.

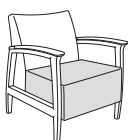

Code
Models
4961-W/M4961-W
4961-U/M4961-U
4980-ST/AO/EU
M4980-ST/AO/EU

HA5
COM Requirement
Seat Cushion Only = $1\frac{1}{4}$ yds.
Balance of Chair = $1\frac{3}{4}$ yds.

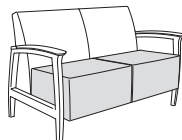

Code
Model
4962-W/M4962-W
4962-U/M4962-U

HA6
COM Requirement
Seat Cushion Only = $2\frac{1}{2}$ yds.
Balance of Love Seat = $3\frac{1}{2}$ yds.

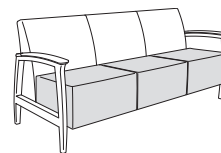

Code
Model
4963-W/M4963-W
4963-U/M4963-U

HA7
COM Requirement
Seat Cushion Only = $3\frac{1}{2}$ yds.
Balance of Sofa = 5 yds.



Code
Model
4965-U/M4965-U
4971-W/M4971-W

HA8
COM Requirement
Seat Cushion Only = $1\frac{1}{4}$ yds.
Balance of Chair = $4\frac{3}{4}$ yds.

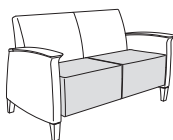

Code
Model
4966-U/M4966-U
4972-W/M4972-W

HA9
COM Requirement
Seat Cushion Only = $2\frac{1}{2}$ yds.
Balance of Love Seat = $5\frac{3}{4}$ yds.

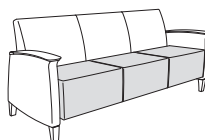

Code
Model
4967-U/M4967-U
4973-W/M4973-W

HA10
COM Requirement
Seat Cushion Only = $3\frac{1}{2}$ yds.
Balance of Sofa = 7 yds.

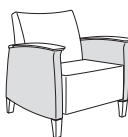

Code
Model
4965-U/M4965-U
4971-W/M4971-W

HA11
COM Requirement
Arm Panels = $2\frac{3}{4}$ yds.
Balance of Chair = 3 yds.

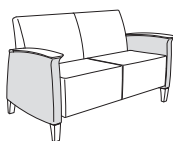

Code
Model
4966-U/M4966-U
4972-W/M4972-W

HA12
COM Requirement
Arm Panels = $2\frac{3}{4}$ yds.
Balance of Love Seat = 6 yds.

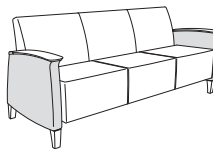

Code
Model
4967-U/M4967-U
4973-W/M4973-W

HA13
COM Requirement
Arm Panels = $2\frac{3}{4}$ yds.
Balance of Sofa = $8\frac{1}{2}$ yds.



Code
Model
4975/M4975

HA14
COM Requirement
Seat Cushion Only = $1\frac{1}{4}$ yds.
Balance of Chair = 4 yds.

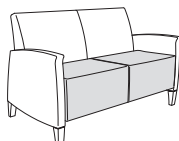

Code
Model
4976/M4976

HA15
COM Requirement
Seat Cushion Only = $2\frac{1}{2}$ yds.
Balance of Love Seat = $5\frac{3}{4}$ yds.

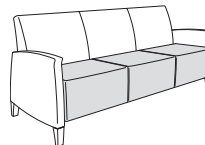

Code
Model
4977/M4977

HA16
COM Requirement
Seat Cushion Only = $3\frac{1}{2}$ yds.
Balance of Sofa = 7 yds.

HAVEN LOUNGE // DESIGNED BY DAVID DAHL

UPHOLSTERY COMBINATIONS:

- » When combining two COM/COV/COL fabrics, or fabrics with the same grade, add \$120 List per unit.
- » When combining three COM/COV/COL fabrics, or fabrics with the same grade, add \$150 List per unit.
- » When combining different grades of fabric, price will be based on the highest grade specified.
- » Two-tone upholstery examples and yardage requirements for the most common combinations are listed below. Additional combinations available, please contact client services for yardage requirements and pricing.
- » Note: Yardage amounts are based on fabric which is plain (i.e. non-directional) and a full 54" wide.
- » Appropriate upholstery code must be included.



Code **HA17**
Models COM Requirement
 4975/M4975 Arms = 2³/₄ yds.
 Balance of Chair = 3 yds.

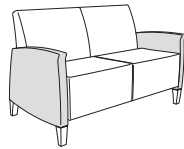

Code **HA18**
Model COM Requirement
 4976/M4976 Arms = 2³/₄ yds.
 Balance of Love Seat = 6 yds.

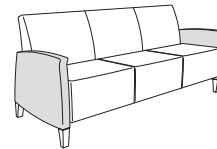

Code **HA19**
Model COM Requirement
 4977/M4977 Arms = 2³/₄ yds.
 Balance of Sofa = 8¹/₂ yds.



Code **HA20**
Model COM Requirement
 4961-W/M4961-W Inside Back/Top of Seat = 1 yd.
 4961-U/M4961-U Balance of Chair = 2 yds.

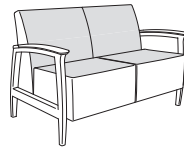

Code **HA21**
Model COM Requirement
 4962-W/M4962-W Inside Back/Top of Seat = 2 yds.
 4962-U/M4962-U Balance of Love Seat = 3¹/₂ yds.

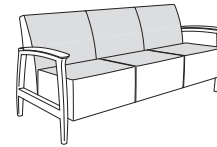

Code **HA22**
Model COM Requirement
 4963-W/M4963-W Inside Back/Top of Seat = 3 yds.
 4963-U/M4963-U Balance of Sofa = 5 yds.



Code **HA23**
Model COM Requirement
 4965-U/M4965-U Inside Back/Top of Seat = 1 yd.
 4971-W/M4971-W Balance of Chair = 4 yds.

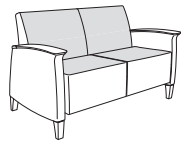

Code **HA24**
Model COM Requirement
 4966-U/M4966-U Inside Back/Top of Seat = 2 yds.
 4972-W/M4972-W Balance of Love Seat = 6¹/₂ yds.

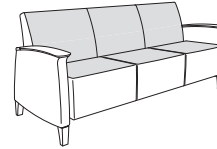

Code **HA25**
Model COM Requirement
 4967-U/M4967-U Inside Back/Top of Seat = 3 yds.
 4973-W/M4973-W Balance of Sofa = 7¹/₂ yds.



Code **HA26**
Model COM Requirement
 4975/M4975 Inside Back/Top of Seat = 1 yd.
 Balance of Chair = 4 yds.

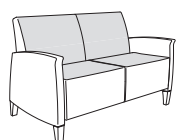

Code **HA27**
Model COM Requirement
 4976/M4976 Inside Back/Top of Seat = 2 yds.
 Balance of Love Seat = 6 yds.

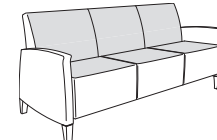

Code **HA28**
Model COM Requirement
 4977/M4977 Inside Back/Top of Seat = 3 yds.
 Balance of Sofa = 8 yds.

HAVEN BENCHES // DESIGNED BY DAVID DAHL



PRODUCT FEATURES/SPECIFICATIONS:

- » Benches available in 2-seat, 2-seat with center table and 3-seat options.
- » Beech wood or metal legs.
- » Wood legs and center table available in all standard and custom wood finishes on beech.
- » For Super Matte Sable Beech, premium wood finish upcharge applies. Refer to options section for pricing.
- » For custom wood finishes, please add one-time upcharge of \$514 List per color per order.
- » Metal legs available in two finishes.
- » Maximum weight capacity is 800 lbs. for two-seat benches and 1200 lbs. for three-seat benches.
- » All dimensions are nominal.

METAL LEG FINISHES:

- » 0405 Charcoal Grey
- » 0535 Metallic Silver

ORDERING REQUIREMENTS:

- » Model number
- » Leg finish
- » Upholstery selection
- » Table finish, as applicable
- » Options, as applicable

HAVEN BENCHES // DESIGNED BY DAVID DAHL

ORDERING REQUIREMENTS:

- » Model number
- » Leg finish
- » Upholstery selection
- » Table finish, as applicable
- » Options, as applicable

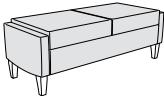
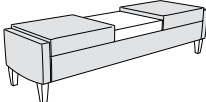
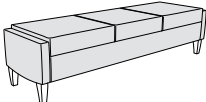
MODEL NUMBER	PRODUCT SPECIFICATIONS		FABRIC GRADES										LEATHER	
			COM	A	1	2	COL		3	4	5	6	7	8
4992 (WOOD LEGS) M4992 (METAL LEGS) 	Two-Seat Bench W 50 ¹ / ₂ D 21 H 18 Seat Height 18 3 yds. 66 lbs. COL 60 sq. ft.	Wood Legs	2123	2318	2414	2474	2570	2675	2774	2873	2966	3077	3530	3875
		Metal Legs	2062	2257	2353	2413	2509	2614	2713	2812	2905	3016	3469	3814
4992-CT (WOOD LEGS) M4992-CT (METAL LEGS) 	Two-Seat Bench with Center Table W 72 D 21 H 18 Seat Height 18 3 ¹ / ₂ yds. 98 lbs. COL 70 sq. ft.	Wood Legs	2951	3179	3291	3361	3473	3595	3711	3826	3935	4064	4593	4995
		Metal Legs	2866	3094	3206	3276	3388	3510	3626	3741	3850	3979	4508	4910
4993 (WOOD LEGS) M4993 (METAL LEGS) 	Three-Seat Bench W 72 D 21 H 18 Seat Height 18 4 ¹ / ₄ yds. 98 lbs. COL 85 sq. ft.	Wood Legs	2711	2988	3124	3209	3345	3493	3634	3774	3906	4063	4705	5193
		Metal Legs	2630	2907	3043	3128	3264	3412	3553	3693	3825	3982	4624	5112

OPTIONS		
-PFW01	Premium Wood Finish, Legs	12
-PFW04	Premium Wood Finish, Inline Table	44
-MB03	Moisture Barrier, Two-Seat Benches	201
-MB04	Moisture Barrier, Three-Seat Benches	234
-NS04	Non-Skid Glides	29

HAVEN BENCHES // DESIGNED BY DAVID DAHL

UPHOLSTERY COMBINATIONS:

- » When combining two COM/COV/COL fabrics, or fabrics with the same grade, add \$120 List per unit.
- » When combining three COM/COV/COL fabrics, or fabrics with the same grade, add \$150 List per unit.
- » When combining different grades of fabric, price will be based on the highest grade specified.
- » Two-tone upholstery examples and yardage requirements for the most common combinations are listed below. Additional combinations available, please contact client services for yardage requirements and pricing.
- » Note: Yardage amounts are based on fabric which is plain (i.e. non-directional) and a full 54" wide.
- » Appropriate upholstery code must be included.

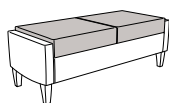

Code HA42

<u>Models</u>	<u>COM Requirement</u>
4992	Seat Cushion Only = 2 yds.
M4992	Balance of Bench = 2 yds.

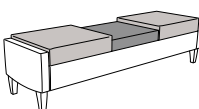

Code HA43

<u>Models</u>	<u>COM Requirement</u>
4992-CT	Seat Cushion Only = 2 yds.
M4992-CT	Balance of Bench = 2 ¹ / ₄ yds.

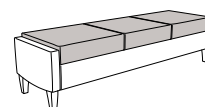

Code HA44

<u>Models</u>	<u>COM Requirement</u>
4993	Seat Cushion Only = 3 yds.
M4993	Balance of Bench = 2 ¹ / ₄ yds.

HAVEN TABLES



MARCH 1, 2026
VA IDIQ CONTRACT (FY26)
(DEALER HELD)

HAVEN OCCASIONAL TABLES // DESIGNED BY DAVID DAHL



PRODUCT FEATURES/SPECIFICATIONS:

- » Tables available with beech wood or metal legs.
- » All tables feature veneer tops as standard. Laminate and Corian tops available.
- » For custom laminates, add \$642 List per color per order. Pre-approval required, please contact client services.
- » For Corian top, specify “-CO” next to model number. Corian top is affixed to table top surface increasing overall table height by 1/2”.
- » All standard wood finishes available on beech.
- » For Super Matte Sable Beech, premium wood finish upcharge applies. Refer to options section for pricing.
- » For custom wood finishes, please add one-time upcharge of \$514 List per color per order.
- » Two-tone wood finishing available at no upcharge.
- » Metal legs available in two finishes.
- » For non-standard Corian and metal finishes, please contact client services.
- » All dimensions are nominal.

CORIAN® COLORS:

- » CWN Designer White
- » CLN Linen
- » CTD Witch Hazel
- » CRC Rain Cloud
- » CGQ Grey Onyx
- » CSQ Stonique

METAL LEG FINISHES:

- » 0405 Charcoal Grey
- » 0535 Metallic Silver





ORDERING REQUIREMENTS:

- » Model number
- » Top finish
- » Wood or metal leg finish

HAVEN OCCASIONAL TABLES // DESIGNED BY DAVID DAHL

ORDERING REQUIREMENTS:

- » Model number
- » Top finish
- » Wood or metal leg finish

		MODEL NUMBER	VENEER OR LAMINATE	CORIAN (-CO)	WEIGHT (Veneer/Laminate Top)
490 (WOOD SERIES) 	Haven Round Table, Wood Legs 18" Dia. x 18" H 24" Dia. x 20" H 30" Dia. x 20" H 36" Dia. x 20" H	490-1818	1773	2164	15
		490-2420	1878	2608	18
		490-3020	2108	3272	27
		490-3620	2567	4663	32
495 (WOOD SERIES) 	Haven Square/Rectangle Table Wood Legs 18" W x 18" L x 20" H 24" W x 24" L x 20" H 30" W x 30" L x 20" H 36" W x 36" L x 20" H 48" W x 20" L x 16" H	495-181820	1684	2077	17
		495-242420	1788	2518	20
		495-303020	2022	3189	30
		495-363620	2443	4544	35
		495-482016	2351	3850	42
M490 (METAL SERIES) 	Haven Round Table, Metal Legs 18" Dia. x 18" H 24" Dia. x 20" H 30" Dia. x 20" H 36" Dia. x 20" H	M490-1818	1720	2111	20
		M490-2420	1825	2555	23
		M490-3020	2044	3209	32
		M490-3620	2490	4591	37
M495 (METAL SERIES) 	Haven Square/Rectangle Table Metal Legs 18" W x 18" L x 20" H 24" W x 24" L x 20" H 30" W x 30" L x 20" H 36" W x 36" L x 20" H 48" W x 20" L x 16" H	M495-181820	1635	2028	22
		M495-242420	1735	2470	25
		M495-303020	1962	3131	35
		M495-363620	2370	4472	40
		M495-482016	2281	3782	47

OPTIONS

-PFW04	Premium Wood Finish	44
--------	---------------------	----

LEAF SEATING



LEAF BENCHES // DESIGNED BY DAVID DAHL



PRODUCT FEATURES/SPECIFICATIONS:

- » Bench units available individually or in modular combinations with connecting tables.
- » Mid-size benches and connecting tables available in five sizes to enable straight or curved configurations. Full-size bench offered in one size only.
- » All models come standard with four (4) 5¹/₂" high beech wood or metal legs.
- » All standard and custom wood finishes available on beech.
- » For Super Matte Sable Beech, premium wood finish upcharge applies. Refer to options section for pricing.
- » For custom finishes to legs, tables and/or rotating tablet, please add one-time upcharge of \$514 List per color per order.
- » Metal legs available in three finishes.
- » Maximum weight capacity is 750 lbs.
- » Models can join together as is, or to reduce the amount of legs as well as provide a more permanent connection, a ganging leg option is also available.
- » All dimensions are nominal.

METAL LEG FINISHES:

- » 0299 Polished Aluminum
- » 0405 Charcoal Grey
- » 0535 Metallic Silver

CONNECTING TABLE SPECIFICATIONS:

- » Available in maple, walnut and white oak, in all standard and custom wood finishes.
- » Premium wood finish upcharge applies to the following wood finishes. Refer to options section for pricing.
 - Super Matte Sable Maple
 - Alabaster Oak
 - Super Matte Sable Oak
- » For custom finishes to tables, legs and/or rotating tablet, please add one-time upcharge of \$514 List per color per order.
- » Laminate top standard with laminate body, unless otherwise advised.
- » For Corian top, body will be veneer as standard, finish must be specified. For a laminate body, please contact client services for pricing.
- » Corian top is affixed to table surface increasing overall table height by 1/2". Please note that a 1/8" reveal will be present.
- » Tables join together with all lounge, bench and mid-size bench models as well as Leaflette lounge and bench units.

LEAF BENCHES // DESIGNED BY DAVID DAHL

CORIAN® COLORS:

- » CWN Designer White
- » CLN Linen
- » CTD Witch Hazel
- » CRC Rain Cloud
- » CGQ Grey Onyx
- » CSQ Stonique



MODULAR ARRANGEMENTS:

- » Ganging leg connects two units together and reduces the overall quantity of legs.
- » To specify, please refer to units with “-G” in the model number.
- » **Note: Please include layout drawings or sketch with each order.**
- » Field assembly required.

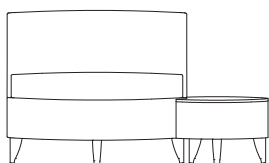

Standard Leg - Front View

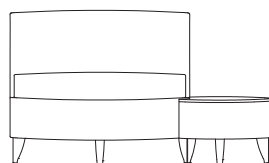

Ganging Leg - Front View

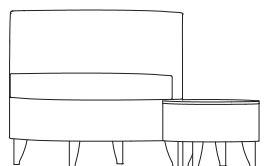

Standard Leg - Side View

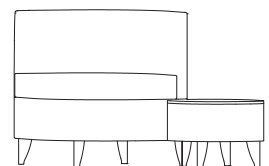

Ganging Leg - Side View





ORDERING REQUIREMENTS:

- » **Model number**
- » **Leg finish**
- » **Upholstery selection**
- » **Options, as applicable**

LEAF BENCHES // DESIGNED BY DAVID DAHL

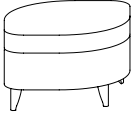
ORDERING REQUIREMENTS:

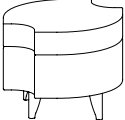
- » Model number
- » Leg finish
- » Upholstery selection
- » Options, as applicable

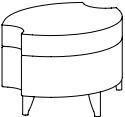
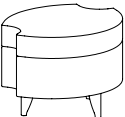
MODEL NUMBER	PRODUCT SPECIFICATIONS	FABRIC GRADES										LEATHER	
		COM	A	1	2	COL		3	4	5	6	7	8
3705 	Full Size Bench W 37 D 27 ¹ / ₄ H 18 ¹ / ₂ Seat Height 18 ¹ / ₂ 2 yds. 30 lbs. COL 40 sq. ft.	1808	1938	2002	2042	2106	2176	2242	2308	2370	2444	2746	2976
3710 	Mid-Size Bench W 28 ³ / ₄ D 21 ¹ / ₂ H 18 ¹ / ₂ Seat Height 18 ¹ / ₂ 1 ³ / ₄ yds. 28 lbs. COL 35 sq. ft.	1799	1913	1969	2004	2060	2121	2179	2237	2291	2356	2620	2821
3715 	Mid-Size Inline Bench W 23 ¹ / ₂ D 21 ¹ / ₂ H 18 ¹ / ₂ Seat Height 18 ¹ / ₂ 1 ³ / ₄ yds. 27 lbs. COL 35 sq. ft.	1731	1845	1901	1936	1992	2053	2111	2169	2223	2288	2552	2753
3720 	Mid-Size Inline/End Bench W 26 D 21 ¹ / ₂ H 18 ¹ / ₂ Seat Height 18 ¹ / ₂ 1 ³ / ₄ yds. 27 lbs. COL 35 sq. ft.	1755	1869	1925	1960	2016	2077	2135	2193	2247	2312	2576	2777
3730 	Mid-Size 30-Degree Bench W 27 ¹ / ₄ D 21 ¹ / ₂ H 18 ¹ / ₂ Seat Height 18 ¹ / ₂ 1 ¹ / ₂ yds. 27 lbs. COL 30 sq. ft.	1774	1872	1920	1950	1998	2050	2100	2149	2196	2251	2478	2650
3745 	Mid-Size 45-Degree Bench W 28 D 22 H 18 ¹ / ₂ Seat Height 18 ¹ / ₂ 1 ¹ / ₂ yds. 27 lbs. COL 30 sq. ft.	1801	1899	1947	1977	2025	2077	2127	2176	2223	2278	2505	2677

OPTIONS			
-PFW01	Premium Wood Finish		12
-NS04	Non-Skid Glides		29

LEAF BENCHES // DESIGNED BY DAVID DAHL

ORDERING REQUIREMENTS:

- » Model number
- » Wood species
- » Wood finish
- » Leg finish
- » Options, as applicable

Note: For Corian top, specify '-CO' after model number and select color. Body is veneer as standard, finish must be specified.

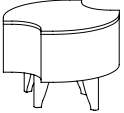
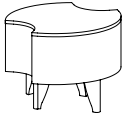
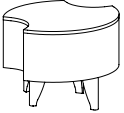
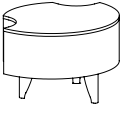
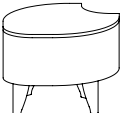
MODEL NUMBER	PRODUCT SPECIFICATIONS	TABLE TOP FINISH	
		VENEER OR LAMINATE	CORIAN (-CO)
3750 	Inline Table W 16 ³ / ₄ D 16 ¹ / ₂ H 13 ¹ / ₄ 15 lbs.	1576	2150
3750-30 	30-Degree Table W 18 ¹ / ₄ D 16 ¹ / ₂ H 13 ¹ / ₄ 15 lbs.	1576	2150
3750-45 	45-Degree Table W 19 D 16 ³ / ₄ H 13 ¹ / ₄ 15 lbs.	1576	2150
3750-90 	90-Degree Table W 23 D 19 H 13 ¹ / ₄ 15 lbs.	1691	2310
3755 	Inline/End Table W 19 D 16 ¹ / ₂ H 13 ¹ / ₄ 15 lbs.	1588	2650





OPTIONS		
-PFW04	Premium Wood Finish	44
-NS04	Non-Skid Glides	29

LEAF BENCHES // DESIGNED BY DAVID DAHL

ORDERING REQUIREMENTS:

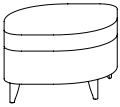
- » Model number
- » Leg finish
- » Upholstery selection
- » Options, as applicable

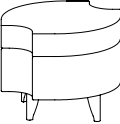
Note: Models below feature ganging leg (-G) to connect units together. Please include layout drawings or sketch with each order.

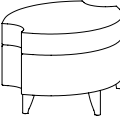
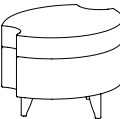
MODEL NUMBER	PRODUCT SPECIFICATIONS	FABRIC GRADES										LEATHER			
		COM	A	1	2	COL			3	4	5	6	7	8	L1
3705-G 	Full Size Bench, Ganging W 37 D 27 ¹ / ₄ H 18 ¹ / ₂ Seat Height 18 ¹ / ₂ 2 yds. 30 lbs. COL 40 sq. ft.	1908	2038	2102	2142	2206	2276	2342	2408	2470	2544	2846	3076		
3710-G 	Mid-Size Bench, Ganging W 28 ¹ / ₄ D 21 ¹ / ₂ H 18 ¹ / ₂ Seat Height 18 ¹ / ₂ 1 ³ / ₄ yds. 26 lbs. COL 35 sq. ft.	1899	2013	2069	2104	2160	2221	2279	2337	2391	2456	2720	2921		
3715-G 	Mid-Size In-Line Bench, Ganging W 23 ¹ / ₂ D 21 ¹ / ₂ H 18 ¹ / ₂ Seat Height 18 ¹ / ₂ 1 ³ / ₄ yds. 25 lbs. COL 35 sq. ft.	1831	1945	2001	2036	2092	2153	2211	2269	2323	2388	2652	2853		
3720-G 	Mid-Size In-Line/End Bench, Ganging W 26 D 21 ¹ / ₂ H 18 ¹ / ₂ Seat Height 18 ¹ / ₂ 1 ³ / ₄ yds. 25 lbs. COL 35 sq. ft.	1855	1969	2025	2060	2116	2177	2235	2293	2347	2412	2676	2877		
3730-G 	Mid-Size 30-Degree Bench, Ganging W 27 ¹ / ₄ D 21 ¹ / ₂ H 18 ¹ / ₂ Seat Height 18 ¹ / ₂ 1 ¹ / ₂ yds. 25 lbs. COL 30 sq. ft.	1874	1972	2020	2050	2098	2150	2200	2249	2296	2351	2578	2750		
3745-G 	Mid-Size 45-Degree Bench, Ganging W 28 D 22 H 18 ¹ / ₂ Seat Height 18 ¹ / ₂ 1 ¹ / ₂ yds. 25 lbs. COL 30 sq. ft.	1901	1999	2047	2077	2125	2177	2227	2276	2323	2378	2605	2777		

OPTIONS		
-PFW01	Premium Wood Finish	12
-NS04	Non-Skid Glides	29



LEAF BENCHES // DESIGNED BY DAVID DAHL

ORDERING REQUIREMENTS:

- » Model number
- » Wood species
- » Wood finish
- » Leg finish
- » Options, as applicable

Note: For Corian top, specify '-CO' after model number and select color. Body is veneer as standard, finish must be specified.

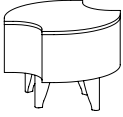
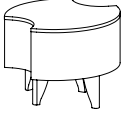
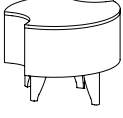
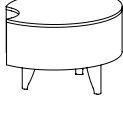
Note: Models below feature ganging leg (-G) to connect units together. Please include layout drawings or sketch with each order.

MODEL NUMBER	PRODUCT SPECIFICATIONS	TABLE TOP FINISH	
		VENEER OR LAMINATE	CORIAN (-CO)
3750-G 	Inline Table, Ganging W 16 ³ / ₄ D 16 ¹ / ₂ H 13 ¹ / ₄ 15 lbs.	1676	2250
3750-30-G 	30-Degree Table, Ganging W 18 ¹ / ₄ D 16 ¹ / ₂ H 13 ¹ / ₄ 15 lbs.	1676	2250
3750-45-G 	45-Degree Table, Ganging W 19 D 16 ³ / ₄ H 13 ¹ / ₄ 15 lbs.	1676	2250
3750-90-G 	90-Degree Table, Ganging W 23 D 19 H 13 ¹ / ₄ 15 lbs.	1791	2410
3755-G 	Inline/End Table, Ganging W 19 D 16 ¹ / ₂ H 13 ¹ / ₄ 15 lbs.	1688	2750

OPTIONS		
-PFW04	Premium Wood Finish	44
-NS04	Non-Skid Glides	29

LEAF BENCHES // DESIGNED BY DAVID DAHL

UPHOLSTERY COMBINATIONS:

- » When combining two COM/COV/COL fabrics, or fabrics with the same grade, add \$120 List per unit.
- » When combining three COM/COV/COL fabrics, or fabrics with the same grade, add \$150 List per unit.
- » When combining different grades of fabric, price will be based on the highest grade specified.
- » Two-tone upholstery examples and yardage requirements for the most common combinations are listed below. Additional combinations available, please contact client services for yardage requirements and pricing.
- » Note: Yardage amounts are based on fabric which is plain (i.e. non-directional) and a full 54" wide.
- » Appropriate upholstery code must be included.

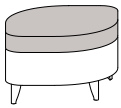

Code LM13

Model COM Requirement
 3705 Seat Cushion = 1¹/₄ yds.
 3705-G Seat Box = ³/₄ yd.

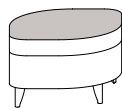

Code LM14

Model COM Requirement
 3705 Top of Seat Only = 1 yd.
 3705-G Balance of Bench = 1 yd.

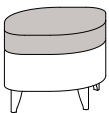

Code LM15

Model COM Requirement
 3710 Seat Cushion = 1¹/₄ yds.
 3710-G Seat Box = ³/₄ yd.

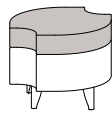

Code LM16

Model COM Requirement
 3715 Seat Cushion = 1¹/₄ yds.
 3715-G Seat Box = ³/₄ yd.

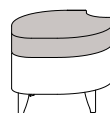

Code LM17

Model COM Requirement
 3720 Seat Cushion = 1¹/₄ yds.
 3720-G Seat Box = ³/₄ yd.



Code LM18

Model COM Requirement
 3730 Seat Cushion = 1¹/₄ yds.
 3730-G Seat Box = ³/₄ yd.



Code LM19

Model COM Requirement
 3745 Seat Cushion = 1¹/₄ yds.
 3745-G Seat Box = ³/₄ yd.



Code LM20

Model COM Requirement
 3710 Top of Seat Only = ³/₄ yd.
 3710-G Balance of Bench = 1¹/₄ yds.

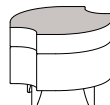

Code LM21

Model COM Requirement
 3715 Top of Seat Only = ³/₄ yd.
 3715-G Balance of Bench = 1¹/₄ yds.

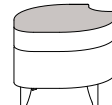

Code LM22

Model COM Requirement
 3720 Top of Seat Only = ³/₄ yd.
 3720-G Balance of Bench = 1¹/₄ yds.



Code LM23

Model COM Requirement
 3730 Top of Seat Only = ³/₄ yd.
 3730-G Balance of Bench = 1¹/₄ yds.



Code LM24

Model COM Requirement
 3745 Top of Seat Only = ³/₄ yd.
 3745-G Balance of Bench = 1¹/₄ yds.

LEAF LOUNGE // DESIGNED BY DAVID DAHL



PRODUCT FEATURES/SPECIFICATIONS:

- » Each unit comes standard with four (4) 5¹/₂" high beech wood or metal legs.
- » All standard and custom wood finishes available on beech.
- » For Super Matte Sable Beech, premium wood finish upcharge applies. Refer to options section for pricing.
- » For custom finishes to legs and/or rotating tablet, please add one-time upcharge of \$514 List per color per order.
- » Metal legs available in 0299 Polished Aluminum and the following finishes: 0405 Charcoal Grey and 0535 Metallic Silver.
- » Available with optional clean-out feature between seat and back for maintenance ease (model number designated with a -V).
- » Maximum weight capacity is 750 lbs. for lounge chair and 1000 lbs. for love seat.
- » All dimensions are nominal.

METAL LEG FINISHES:

- » 0299 Polished Aluminum
- » 0405 Charcoal Grey
- » 0535 Metallic Silver

ROTATING TABLET:

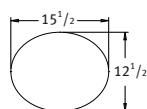

Tablet Shape

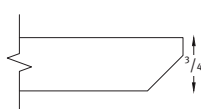

Veneer/Laminate Top - Edge Profile

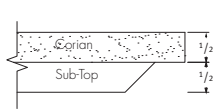

Corian Top - Edge Profile

- » Affixed to right or left side, as specified.
- » Tablet size is 15¹/₂" W x 12¹/₂" D x 3/4" thick with 360-degree turning radius.
- » Surface finish options: veneer, laminate or Corian.
- » Veneer offered in maple, walnut and white oak, in all standard and custom wood finishes.
- » Premium wood finish upcharge applies to the following wood finishes. Refer to options section for pricing.
 - Super Matte Sable Maple
 - Alabaster Oak
 - Super Matte Sable Oak
- » For custom wood finishes, please add one-time upcharge of \$514 List per color per order.
- » Laminate is applied to tablet top surface only.
- » For custom laminates, add \$642 List per color per order. Pre-approval required, please contact client services.
- » Refer to Terms and Conditions for edge finish details.

LEAF LOUNGE // DESIGNED BY DAVID DAHL

ROTATING TABLET CONTINUED:

- » For maximum durability, a Corian tablet or laminate surface with a clear coat edge finish is recommended.
- » Tablet mounting post available in 0199 Chrome and the following finishes: 0405 Charcoal Grey and 0535 Metallic Silver.
- » Tablet mounting post will match leg finish unless otherwise specified. For legs finished in 0299 Polished Aluminum, tablet mounting post will be 0199 Chrome as standard.

CORIAN® COLORS:

- » CWN Designer White
- » CLN Linen
- » CTD Witch Hazel
- » CRC Rain Cloud
- » CGQ Grey Onyx
- » CSQ Stonique

ORDERING REQUIREMENTS:

- » Model number
- » Leg finish
- » Upholstery selection
- » Options, as applicable

LEAF LOUNGE // DESIGNED BY DAVID DAHL

ORDERING REQUIREMENTS:

- » Model number
- » Leg finish
- » Upholstery selection
- » Options, as applicable

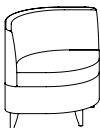
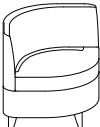
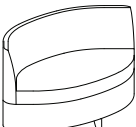
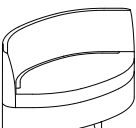
MODEL NUMBER	PRODUCT SPECIFICATIONS	FABRIC GRADES										LEATHER			
		COM	A	1	2	COL		3	4	5	6	7	8	L1	L2
3700 	Lounge Chair W 37 D 27 ¹ / ₄ H 31 Seat Height 18 ¹ / ₂ Inside Seat Width 33 Inside Seat Depth 22 3 yds. 45 lbs. COL 60 sq. ft.	2257	2452	2548	2608	2704	2809	2908	3007	3100	3211	3664	4009		
3700-V 	Lounge Chair with Clean-Out W 37 D 27 ¹ / ₄ H 31 Seat Height 18 ¹ / ₂ Inside Seat Width 33 Inside Seat Depth 23 ¹ / ₄ 3 ³ / ₄ yds. 45 lbs. COL 75 sq. ft.	2391	2635	2755	2830	2950	3081	3205	3329	3445	3584	4150	4581		
3702 	Love Seat W 55 D 29 ¹ / ₄ H 31 Seat Height 18 ¹ / ₂ Inside Seat Width 48 Inside Seat Depth 22 5 yds. 55 lbs. COL 100 sq. ft.	3283	3608	3768	3868	4028	4203	4368	4533	4688	4873	5628	6203		
3702-V 	Love Seat with Clean-Out W 55 D 29 ¹ / ₄ H 31 Seat Height 18 ¹ / ₂ Inside Seat Width 48 Inside Seat Depth 23 ¹ / ₄ 5 ¹ / ₂ yds. 55 lbs. COL 110 sq. ft.	3406	3764	3940	4050	4226	4418	4600	4781	4952	5155	5986	6618		

OPTIONS

-PFW01	Premium Wood Finish	12
-TAR03	Veneer/Laminate Rotating Tablet, Right (as seated)	544
-TAL03	Veneer/Laminate Rotating Tablet, Left (as seated)	544
-TAR03-CO	Corian Rotating Tablet, Right (as seated)	896
-TAL03-CO	Corian Rotating Tablet, Left (as seated)	896
-NS04	Non-Skid Glides	29

LEAF LOUNGE // DESIGNED BY DAVID DAHL

UPHOLSTERY COMBINATIONS:

- » When combining two COM/COV/COL fabrics, or fabrics with the same grade, add \$120 List per unit.
- » When combining three COM/COV/COL fabrics, or fabrics with the same grade, add \$150 List per unit.
- » When combining different grades of fabric, price will be based on the highest grade specified.
- » Two-tone upholstery examples and yardage requirements for the most common combinations are listed below. Additional combinations available, please contact client services for yardage requirements and pricing.
- » Note: Yardage amounts are based on fabric which is plain (i.e. non-directional) and a full 54" wide.
- » Appropriate upholstery code must be included.

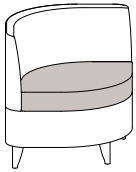

Code LM1

Model COM Requirement
3700 Seat Cushion Only = 1 yd.
Balance of Chair = 2¹/₂ yds.

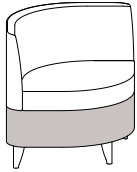

Code LM2

Model COM Requirement
3700 Seat Box Only = ³/₄ yd.
Balance of Chair = 2¹/₂ yds.

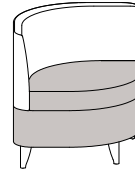

Code LM3

Model COM Requirement
3700 Seat Cushion & Seat Box = 1³/₄ yds.
Balance of Chair = 1³/₄ yds.

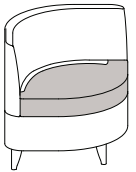

Code LM4

Models COM Requirement
3700-V Seat Cushion Only = 1¹/₄ yd.
Balance of Chair = 2¹/₂ yds.

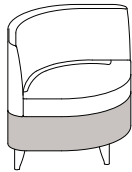

Code LM5

Models COM Requirement
3700-V Seat Box Only = 1 yd.
Balance of Chair = 2³/₄ yds.

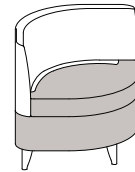

Code LM6

Models COM Requirement
3700-V Seat Cushion & Seat Box = 2¹/₄ yds.
Balance of Chair = 2 yds.

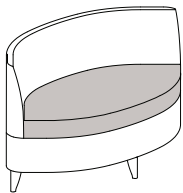

Code LM7

Models COM Requirement
3702 Seat Cushion Only = 1¹/₂ yds.
Balance of Love Seat = 3¹/₂ yds.

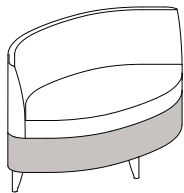

Code LM8

Models COM Requirement
3702 Seat Box Only = 1¹/₂ yds.
Balance of Love Seat = 3¹/₂ yds.

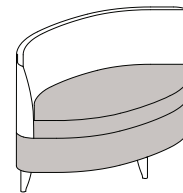

Code LM9

Models COM Requirement
3702 Seat Cushion & Seat Box = 3 yds.
Balance of Love Seat = 2¹/₂ yds.

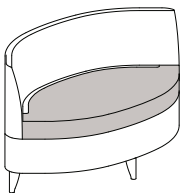

Code LM10

Models COM Requirement
3702-V Seat Cushion Only = 2 yds.
Balance of Love Seat = 3³/₄ yds.

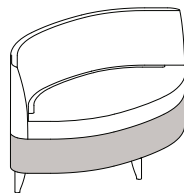

Code LM11

Models COM Requirement
3702-V Seat Box Only = 1³/₄ yds.
Balance of Love Seat = 4¹/₄ yds.

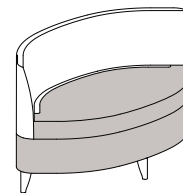

Code LM12

Models COM Requirement
3702-V Seat Cushion & Seat Box = 3¹/₄ yds.
Balance of Love Seat = 2³/₄ yds.

LEAF MODULAR // DESIGNED BY DAVID DAHL



PRODUCT FEATURES/SPECIFICATIONS:

- » Models include lounge chair, love seat, mid-size benches, a full-size bench and connecting tables.
- » Mid-size benches and connecting tables available in five sizes to enable straight or curved configurations. Full-size bench offered in one size only.
- » All models come standard with four (4) 5¹/₂" high beech wood or metal legs.
- » All standard and custom wood finishes available on beech.
- » For Super Matte Sable Beech, premium wood finish upcharge applies. Refer to options section for pricing.
- » For custom finishes to legs, tables and/or rotating tablet, please add one-time upcharge of \$514 List per color per order.
- » Metal legs available in three finishes.
- » Lounge and love seat models available with optional clean-out feature between seat and back for maintenance ease (model number designated with a -V).
- » Maximum weight capacity is 750 lbs. for lounge chair and 1000 lbs. for love seat.
- » Models can join together as is, or to reduce the amount of legs as well as provide a more permanent connection, a ganging leg option is also available.
- » All dimensions are nominal.

METAL LEG FINISHES:

- » 0299 Polished Aluminum
- » 0405 Charcoal Grey
- » 0535 Metallic Silver

CONNECTING TABLE SPECIFICATIONS:

- » Available in maple, walnut and white oak, in all standard and custom wood finishes.
- » Premium wood finish upcharge applies to the following wood finishes. Refer to options section for pricing.
 - Super Matte Sable Maple
 - Alabaster Oak
 - Super Matte Sable Oak
- » For custom finishes to tables, legs and/or rotating tablet, please add one-time upcharge of \$514 List per color per order.
- » Laminate top standard with laminate body, unless otherwise advised.
- » For Corian top, body will be veneer as standard, finish must be specified. For a laminate body, please contact client services for pricing.
- » Corian top is affixed to table surface increasing overall table height by 1/2". Please note that a 1/8" reveal will be present.
- » Tables join together with all lounge, bench and mid-size bench models as well as Leaflette lounge and bench units.

LEAF MODULAR // DESIGNED BY DAVID DAHL

CORIAN® COLORS:

- » CWN Designer White » CRC Rain Cloud
- » CLN Linen » CGQ Grey Onyx
- » CTD Witch Hazel » CSQ Stonique

ROTATING TABLET FEATURES/SPECIFICATIONS:

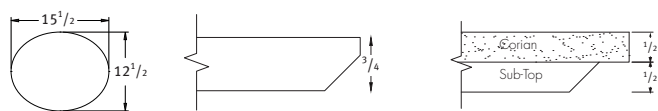

Tablet Shape

Veneer/Laminate Top - Edge Profile

Corian Top - Edge Profile

- » Available on lounge and love seat models and is affixed to right or left arm/side, as specified.
- » Tablet size is 15¹/₂" W x 12¹/₂" D x 3³/₄" thick with 360-degree turning radius.
- » Surface finish options: veneer, laminate or Corian.
- » Veneer offered in maple, walnut and white oak, in all standard and custom wood finishes.
- » Premium wood finish upcharge applies to the following wood finishes. Refer to options section for pricing.
 - Super Matte Sable Maple
 - Alabaster Oak
 - Super Matte Sable Oak
- » For custom wood finishes, please add one-time upcharge of \$514 List per color per order.
- » Laminate is applied to tablet top surface only.
- » For custom laminates, add \$642 List per color per order. Pre-approval required, please contact client services.
- » Refer to Terms and Conditions for edge finish details.
- » For maximum durability, a Corian tablet or laminate surface with a clear coat edge finish is recommended.
- » Mounting post available in 0199 Chrome and the following finishes: 0405 Charcoal Grey and 0535 Metallic Silver.
- » Mounting post will match leg finish unless otherwise specified. For legs finished in 0299 Polished Aluminum, tablet mounting post will be 0199 Chrome as standard.

MODULAR ARRANGEMENTS:

- » Ganging leg connects two units together and reduces the overall quantity of legs.
- » To specify, please refer to units with "-G" in the model number.
- » **Note: Please include layout drawings or sketch with each order.**
- » Field assembly required.

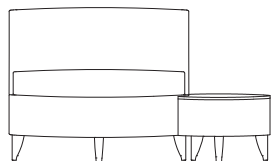

Standard Leg - Front View

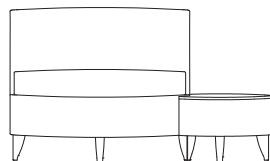

Ganging Leg - Front View

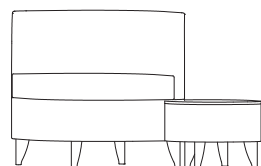

Standard Leg - Side View

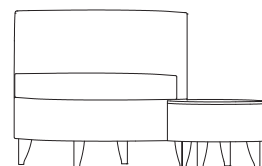

Ganging Leg - Side View

ORDERING REQUIREMENTS:

- » Model number
- » Leg finish
- » Upholstery selection
- » Options, as applicable

LEAF MODULAR // DESIGNED BY DAVID DAHL

ORDERING REQUIREMENTS:

- » Model number
- » Leg finish
- » Upholstery selection
- » Options, as applicable

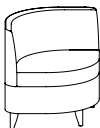
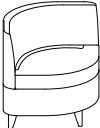
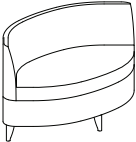
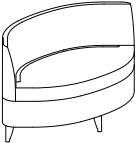
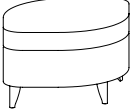

MODEL NUMBER	PRODUCT SPECIFICATIONS	FABRIC GRADES										LEATHER	
		COM	A	1	2	COL					L1	L2	
3700 	Lounge Chair W 37 D 27 ¹ / ₄ H 31 Seat Height 18 ¹ / ₂ Inside Seat Width 33 Inside Seat Depth 22 3 yds. 45 lbs. COL 60 sq. ft.	2257	2452	2548	2608	2704	2809	2908	3007	3100	3211	3664	4009
3700-V 	Lounge Chair with Clean-Out W 37 D 27 ¹ / ₄ H 31 Seat Height 18 ¹ / ₂ Inside Seat Width 33 Inside Seat Depth 23 ¹ / ₄ 3 ³ / ₄ yds. 45 lbs. COL 75 sq. ft.	2391	2635	2755	2830	2950	3081	3205	3329	3445	3584	4150	4581
3702 	Love Seat W 55 D 29 ¹ / ₄ H 31 Seat Height 18 ¹ / ₂ Inside Seat Width 48 Inside Seat Depth 22 5 yds. 55 lbs. COL 100 sq. ft.	3283	3608	3768	3868	4028	4203	4368	4533	4688	4873	5628	6203
3702-V 	Love Seat with Clean-Out W 55 D 29 ¹ / ₄ H 31 Seat Height 18 ¹ / ₂ Inside Seat Width 48 Inside Seat Depth 23 ¹ / ₄ 5 ¹ / ₂ yds. 55 lbs. COL 110 sq. ft.	3406	3764	3940	4050	4226	4418	4600	4781	4952	5155	5986	6618
3705 	Full Size Bench W 37 D 27 ¹ / ₄ H 18 ¹ / ₂ Seat Height 18 ¹ / ₂ 2 yds. 30 lbs. COL 40 sq. ft.	1808	1938	2002	2042	2106	2176	2242	2308	2370	2444	2746	2976

OPTIONS		
-PFW01	Premium Wood Finish	12
-TAR03	Veneer/Laminate Rotating Tablet, Right (as seated)	544
-TAL03	Veneer/Laminate Rotating Tablet, Left (as seated)	544
-TAR03-CO	Corian Rotating Tablet, Right (as seated)	896
-TAL03-CO	Corian Rotating Tablet, Left (as seated)	896
-MB02	Moisture Barrier, Lounge Chair (with or without clean-out)	133
-MB03	Moisture Barrier, Love Seat (with or without clean-out)	201
-NS04	Non-Skid Glides	29

LEAF MODULAR // DESIGNED BY DAVID DAHL

ORDERING REQUIREMENTS:

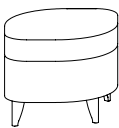
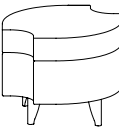
- » Model number
- » Leg finish
- » Upholstery selection
- » Options, as applicable

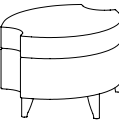
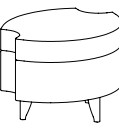



MODEL NUMBER	PRODUCT SPECIFICATIONS	FABRIC GRADES										LEATHER	
		COM	A	1	2	COL		3	4	5	6	7	8
3710 	Mid-Size Bench W 28 ¹ / ₄ D 21 ¹ / ₂ H 18 ¹ / ₂ Seat Height 18 ¹ / ₂ 1 ³ / ₄ yds. 28 lbs. COL 35 sq. ft.	1799	1913	1969	2004	2060	2121	2179	2237	2291	2356	2620	2821
3715 	Mid-Size In-Line Bench W 23 ¹ / ₂ D 21 ¹ / ₂ H 18 ¹ / ₂ Seat Height 18 ¹ / ₂ 1 ³ / ₄ yds. 27 lbs. COL 35 sq. ft.	1731	1845	1901	1936	1992	2053	2111	2169	2223	2288	2552	2753
3720 	Mid-Size In-Line/End Bench W 26 D 21 ¹ / ₂ H 18 ¹ / ₂ Seat Height 18 ¹ / ₂ 1 ³ / ₄ yds. 27 lbs. COL 35 sq. ft.	1755	1869	1925	1960	2016	2077	2135	2193	2247	2312	2576	2777
3730 	Mid-Size 30-Degree Bench W 27 ¹ / ₄ D 21 ¹ / ₂ H 18 ¹ / ₂ Seat Height 18 ¹ / ₂ 1 ¹ / ₂ yds. 27 lbs. COL 30 sq. ft.	1774	1872	1920	1950	1998	2050	2100	2149	2196	2251	2478	2650
3745 	Mid-Size 45-Degree Bench W 28 D 22 H 18 ¹ / ₂ Seat Height 18 ¹ / ₂ 1 ¹ / ₂ yds. 27 lbs. COL 30 sq. ft.	1801	1899	1947	1977	2025	2077	2127	2176	2223	2278	2505	2677
OPTIONS													
-PFW01	Premium Wood Finish	12											
-NS04	Non-Skid Glides	29											

LEAF MODULAR // DESIGNED BY DAVID DAHL

ORDERING REQUIREMENTS:

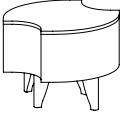
- » Model number
- » Wood species
- » Wood finish
- » Leg finish
- » Options, as applicable

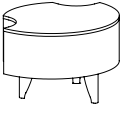
Note: For Corian top, specify '-CO' after model number and select color. Body is veneer as standard, finish must be specified.

MODEL NUMBER	PRODUCT SPECIFICATIONS	TABLE TOP FINISH	
		VENEER OR LAMINATE	CORIAN (-CO)
3750 	Inline Table W 16 ³ / ₄ D 16 ¹ / ₂ H 13 ¹ / ₄ 15 lbs.	1576	2150
3750-30 	30-Degree Table W 18 ¹ / ₄ D 16 ¹ / ₂ H 13 ¹ / ₄ 15 lbs.	1576	2150
3750-45 	45-Degree Table W 19 D 16 ³ / ₄ H 13 ¹ / ₄ 15 lbs.	1576	2150
3750-90 	90-Degree Table W 23 D 19 H 13 ¹ / ₄ 15 lbs.	1691	2310
3755 	Inline/End Table W 19 D 16 ¹ / ₂ H 13 ¹ / ₄ 15 lbs.	1588	2650

OPTIONS		
-PFW04	Premium Wood Finish	44
-NS04	Non-Skid Glides	29

LEAF MODULAR // DESIGNED BY DAVID DAHL

ORDERING REQUIREMENTS:

- » Model number
- » Leg finish
- » Upholstery selection
- » Options, as applicable

Note: Models below feature ganging leg (-G) to connect units together. Please include layout drawings or sketch with each order.

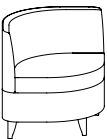
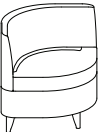
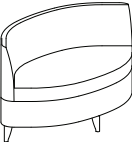
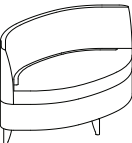
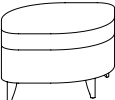
MODEL NUMBER	PRODUCT SPECIFICATIONS	FABRIC GRADES										LEATHER			
		COM	A	1	2	COL		3	4	5	6	7	8	L1	L2
3700-G 	Lounge Chair, Ganging W 37 D 27 ¹ / ₄ H 31 Seat Height 18 ¹ / ₂ Inside Seat Width 33 Inside Seat Depth 22 3 yds. 45 lbs. COL 60 sq. ft.	2357	2552	2648	2708	2804	2909	3008	3107	3200	3311	3764	4109		
3700-V-G 	Lounge Chair with Clean-Out, Ganging W 37 D 27 ¹ / ₄ H 31 Seat Height 18 ¹ / ₂ Inside Seat Width 33 Inside Seat Depth 23 ¹ / ₄ 3 ³ / ₄ yds. 45 lbs. COL 75 sq. ft.	2491	2735	2855	2930	3050	3181	3305	3429	3545	3684	4250	4681		
3702-G 	Love Seat, Ganging W 55 D 29 ¹ / ₄ H 31 Seat Height 18 ¹ / ₂ Inside Seat Width 48 Inside Seat Depth 22 5 yds. 55 lbs. COL 100 sq. ft.	3383	3708	3868	3968	4128	4303	4468	4633	4788	4973	5728	6303		
3702-V-G 	Love Seat with Clean-Out, Ganging W 55 D 29 ¹ / ₄ H 31 Seat Height 18 ¹ / ₂ Inside Seat Width 48 Inside Seat Depth 23 ¹ / ₄ 5 ¹ / ₂ yds. 55 lbs. COL 110 sq. ft.	3506	3864	4040	4150	4326	4518	4700	4881	5052	5255	6086	6718		
3705-G 	Full Size Bench, Ganging W 37 D 27 ¹ / ₄ H 18 ¹ / ₂ Seat Height 18 ¹ / ₂ 2 yds. 30 lbs. COL 40 sq. ft.	1908	2038	2102	2142	2206	2276	2342	2408	2470	2544	2846	3076		



OPTIONS		
-PFW01	Premium Wood Finish	12
-TAR03	Veneer/Laminate Rotating Tablet, Right (as seated)	544
-TAL03	Veneer/Laminate Rotating Tablet, Left (as seated)	544
-TAR03-CO	Corian Rotating Tablet, Right (as seated)	896
-TAL03-CO	Corian Rotating Tablet, Left (as seated)	896
-MB02	Moisture Barrier, Lounge Chair (with or without clean-out)	133
-MB03	Moisture Barrier, Love Seat (with or without clean-out)	201
-NS04	Non-Skid Glides	29

LEAF MODULAR // DESIGNED BY DAVID DAHL

ORDERING REQUIREMENTS:

- » Model number
- » Leg finish
- » Upholstery selection
- » Options, as applicable

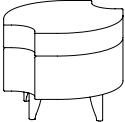
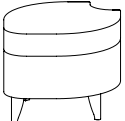
Note: Models below feature ganging leg (-G) to connect units together. Please include layout drawings or sketch with each order.

MODEL NUMBER	PRODUCT SPECIFICATIONS	FABRIC GRADES										LEATHER			
		COM	A	1	2	COL		3	4	5	6	7	8	L1	L2
3710-G 	Mid-Size Bench, Ganging W 28 ¹ / ₄ D 21 ¹ / ₂ H 18 ¹ / ₂ Seat Height 18 ¹ / ₂ 1 ³ / ₄ yds. 26 lbs. COL 35 sq. ft.	1899	2013	2069	2104	2160	2221	2279	2337	2391	2456	2720	2921		
3715-G 	Mid-Size Inline Bench, Ganging W 23 ¹ / ₂ D 21 ¹ / ₂ H 18 ¹ / ₂ Seat Height 18 ¹ / ₂ 1 ³ / ₄ yds. 25 lbs. COL 35 sq. ft.	1831	1945	2001	2036	2092	2153	2211	2269	2323	2388	2652	2853		
3720-G 	Mid-Size Inline/End Bench, Ganging W 26 D 21 ¹ / ₂ H 18 ¹ / ₂ Seat Height 18 ¹ / ₂ 1 ³ / ₄ yds. 25 lbs. COL 35 sq. ft.	1855	1969	2025	2060	2116	2177	2235	2293	2347	2412	2676	2877		
3730-G 	Mid-Size 30-Degree Bench, Ganging W 27 ¹ / ₄ D 21 ¹ / ₂ H 18 ¹ / ₂ Seat Height 18 ¹ / ₂ 1 ¹ / ₂ yds. 25 lbs. COL 30 sq. ft.	1874	1972	2020	2050	2098	2150	2200	2249	2296	2351	2578	2750		
3745-G 	Mid-Size 45-Degree Bench, Ganging W 28 D 22 H 18 ¹ / ₂ Seat Height 18 ¹ / ₂ 1 ¹ / ₂ yds. 25 lbs. COL 30 sq. ft.	1901	1999	2047	2077	2125	2177	2227	2276	2323	2378	2605	2777		
OPTIONS															
-PFW01	Premium Wood Finish	12													
-NS04	Non-Skid Glides	29													



LEAF MODULAR // DESIGNED BY DAVID DAHL

ORDERING REQUIREMENTS:

- » Model number
- » Wood species
- » Wood finish
- » Leg finish
- » Options, as applicable

Note: For Corian top, specify '-CO' after model number and select color. Body is veneer as standard, finish must be specified.

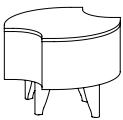
Note: Models below feature ganging leg (-G) to connect units together. Please include layout drawings or sketch with each order.

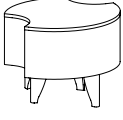
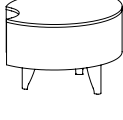
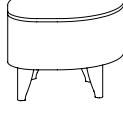
MODEL NUMBER	PRODUCT SPECIFICATIONS	TABLE TOP FINISH	
		VENEER OR LAMINATE	CORIAN (-CO)
3750-G 	Inline Table, Ganging W 16 ³ / ₄ D 16 ¹ / ₂ H 13 ¹ / ₄ 15 lbs.	1676	2250
3750-30-G 	30-Degree Table, Ganging W 18 ¹ / ₄ D 16 ¹ / ₂ H 13 ¹ / ₄ 15 lbs.	1676	2250
3750-45-G 	45-Degree Table, Ganging W 19 D 16 ³ / ₄ H 13 ¹ / ₄ 15 lbs.	1676	2250
3750-90-G 	90-Degree Table, Ganging W 23 D 19 H 13 ¹ / ₄ 15 lbs.	1791	2410
3755-G 	Inline/End Table, Ganging W 19 D 16 ¹ / ₂ H 13 ¹ / ₄ 15 lbs.	1688	2750

OPTIONS		
-PFW04	Premium Wood Finish	44
-NS04	Non-Skid Glides	29

LEAF MODULAR // DESIGNED BY DAVID DAHL

CONFIGURATION EXAMPLES:

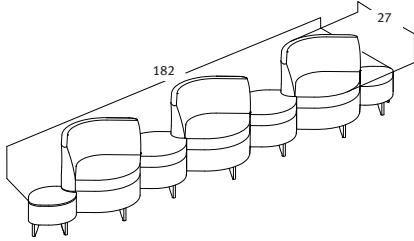

<u>Qty</u>	<u>Model #</u>	<u>Description</u>	<u>COM List</u>
3	3700-G	Lounge Chairs (\$2,351 each)	\$7,593
2	3755-G	Inline/End Tables (\$1,688 each)	\$3,376
2	3715-G	Inline Benches (\$1,831 each)	\$3,662
7			\$14,631

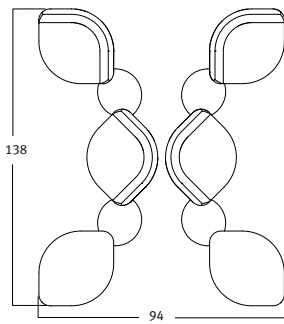

<u>Qty</u>	<u>Model #</u>	<u>Description</u>	<u>COM List</u>
4	3700-G	Lounge Chairs (\$2,351 each)	\$10,124
2	3705-G	Full Size Benches (\$1,908 each)	\$3,816
4	3750-45-G	45-Degree Tables (\$1,576 each)	\$6,304
10			\$20,244

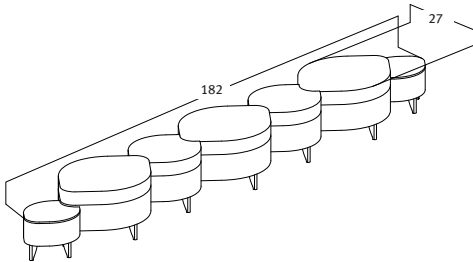

<u>Qty</u>	<u>Model #</u>	<u>Description</u>	<u>COM List</u>
3	3705-G	Full Size Benches (\$1,908 each)	\$5,724
2	3715-G	Mid-Size Inline Benches (\$1,831 each)	\$3,662
2	3755-G	Inline/End Tables (\$1,688 each)	\$3,376
7			\$12,762

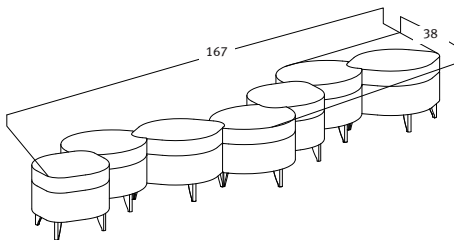

<u>Qty</u>	<u>Model #</u>	<u>Description</u>	<u>COM List</u>
4	3710-G	Mid-Size Benches (\$1,899 each)	\$7,596
3	3745-G	Mid-Size 45-Degree Benches (\$1,901 each)	\$5,703
7			\$13,299

LEAF MODULAR // DESIGNED BY DAVID DAHL

UPHOLSTERY COMBINATIONS:

- » When combining two COM/COV/COL fabrics, or fabrics with the same grade, add \$120 List per unit.
- » When combining three COM/COV/COL fabrics, or fabrics with the same grade, add \$150 List per unit.
- » When combining different grades of fabric, price will be based on the highest grade specified.
- » Two-tone upholstery examples and yardage requirements for the most common combinations are listed below. Additional combinations available, please contact client services for yardage requirements and pricing.
- » Note: Yardage amounts are based on fabric which is plain (i.e. non-directional) and a full 54" wide.
- » Appropriate upholstery code must be included.

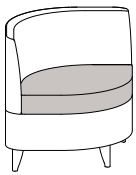

Code LM1

Model COM Requirement
3700 Seat Cushion Only = 1 yd.
Balance of Chair = 2¹/₂ yds.

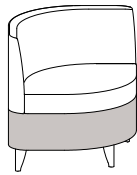

Code LM2

Model COM Requirement
3700 Seat Box Only = 3³/₄ yd.
Balance of Chair = 2¹/₂ yds.

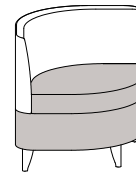

Code LM3

Model COM Requirement
3700 Seat Cushion & Seat Box = 1³/₄ yds.
Balance of Chair = 1³/₄ yds.

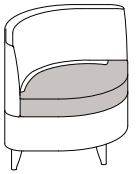

Code LM4

Models COM Requirement
3700-V Seat Cushion Only = 1¹/₄ yd.
Balance of Chair = 2¹/₂ yds.

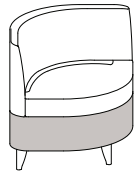

Code LM5

Models COM Requirement
3700-V Seat Box Only = 1 yd.
Balance of Chair = 2³/₄ yds.

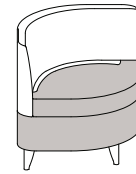

Code LM6

Models COM Requirement
3700-V Seat Cushion & Seat Box = 2¹/₄ yds.
Balance of Chair = 2 yds.

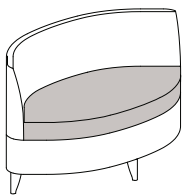

Code LM7

Models COM Requirement
3702 Seat Cushion Only = 1¹/₂ yds.
Balance of Love Seat = 3¹/₂ yds.

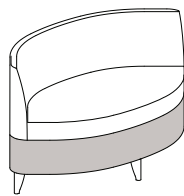

Code LM8

Models COM Requirement
3702 Seat Box Only = 1¹/₂ yds.
Balance of Love Seat = 3¹/₂ yds.

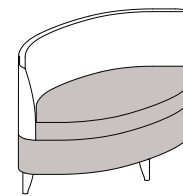

Code LM9

Models COM Requirement
3702 Seat Cushion & Seat Box = 3 yds.
Balance of Love Seat = 2¹/₂ yds.

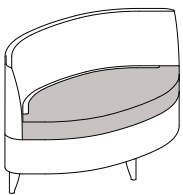

Code LM10

Models COM Requirement
3702-V Seat Cushion Only = 2 yds.
Balance of Love Seat = 3³/₄ yds.

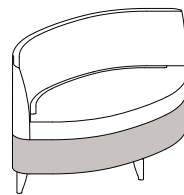

Code LM11

Models COM Requirement
3702-V Seat Box Only = 1³/₄ yds.
Balance of Love Seat = 4¹/₄ yds.

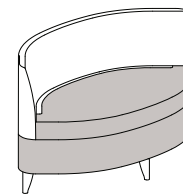

Code LM12

Models COM Requirement
3702-V Seat Cushion & Seat Box = 3¹/₄ yds.
Balance of Love Seat = 2³/₄ yds.

LEAF MODULAR // DESIGNED BY DAVID DAHL

UPHOLSTERY COMBINATIONS:

- » When combining two COM/COV/COL fabrics, or fabrics with the same grade, add \$120 List per unit.
- » When combining three COM/COV/COL fabrics, or fabrics with the same grade, add \$150 List per unit.
- » When combining different grades of fabric, price will be based on the highest grade specified.
- » Two-tone upholstery examples and yardage requirements for the most common combinations are listed below. Additional combinations available, please contact client services for yardage requirements and pricing.
- » Note: Yardage amounts are based on fabric which is plain (i.e. non-directional) and a full 54" wide.
- » Appropriate upholstery code must be included.

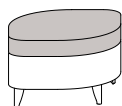

Code LM13

Model COM Requirement
 3705 Seat Cushion = 1¹/₄ yds.
 3705-G Seat Box = 3/4 yd.

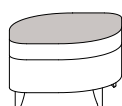

Code LM14

Model COM Requirement
 3705 Top of Seat Only = 1 yd.
 3705-G Balance of Bench = 1 yd.

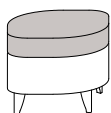

Code LM15

Model COM Requirement
 3710 Seat Cushion = 1¹/₄ yds.
 3710-G Seat Box = 3/4 yd.

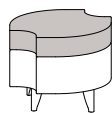

Code LM16

Model COM Requirement
 3715 Seat Cushion = 1¹/₄ yds.
 3715-G Seat Box = 3/4 yd.

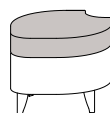

Code LM17

Model COM Requirement
 3720 Seat Cushion = 1¹/₄ yds.
 3720-G Seat Box = 3/4 yd.

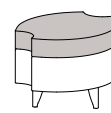

Code LM18

Model COM Requirement
 3730 Seat Cushion = 1¹/₄ yds.
 3730-G Seat Box = 3/4 yd.

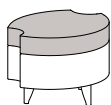

Code LM19

Model COM Requirement
 3745 Seat Cushion = 1¹/₄ yds.
 3745-G Seat Box = 3/4 yd.



Code LM20

Model COM Requirement
 3710 Top of Seat Only = 3/4 yd.
 3710-G Balance of Bench = 1¹/₄ yds.

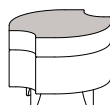

Code LM21

Model COM Requirement
 3715 Top of Seat Only = 3/4 yd.
 3715-G Balance of Bench = 1¹/₄ yds.

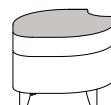

Code LM22

Model COM Requirement
 3720 Top of Seat Only = 3/4 yd.
 3720-G Balance of Bench = 1¹/₄ yds.

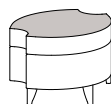

Code LM23

Model COM Requirement
 3730 Top of Seat Only = 3/4 yd.
 3730-G Balance of Bench = 1¹/₄ yds.



Code LM24

Model COM Requirement
 3745 Top of Seat Only = 3/4 yd.
 3745-G Balance of Bench = 1¹/₄ yds.

LINEUP SEATING



arcadia

MARCH 1, 2026
VA IDIQ CONTRACT (FY26)
(DEALER HELD)

LINEUP LOUNGE + MODULAR // DESIGNED BY IDA DESIGN



PRODUCT FEATURES:

- » Lounge, modular and pre-configured booth models.
- » Stand-alone lounge, love seat and sofa models available in three heights.
- » Modular configurations available in five heights for privacy preferences.
- » Pre-configured booths will always be at the maximum height and include slat canopy.
- » Large booth models also include vertical wood panels.
- » Upholstered trim detail below seats will always match seat cushions as standard, unless otherwise specified.
- » **Panels can only be specified in solid color fabrics.**
- » Steel tube legs feature non-skid adjustable glides.
- » Optional power units can be mounted anywhere below the seating units for maximum convenience. Mounting hardware included for in-field attachment. Refer to page 15 for options.
- » Maximum weight capacity is 350 lbs. for lounge chairs, 700 lbs. for love seats and 1000 lbs. for sofas.
- » Collection also includes meeting and occasional tables as well as planters.
- » All dimensions are nominal.

SPECIFICATIONS:

- » Upholstery direction must be specified on corner units when patterned fabrics are selected (seat and/or back cushions only). In the absence of specific instructions, Arcadia reserves the right to upholster units at our discretion.

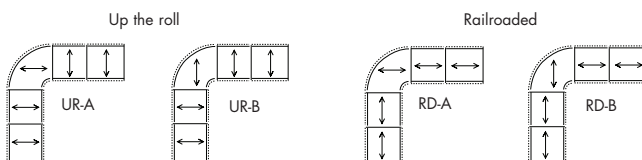

- » Please note that leather is not available on this series.

STANDARD METAL LEG FINISHES:

- » 0405 Charcoal Grey
- » 0535 Metallic Silver
- » 0630 Satin Black

PREMIUM METAL LEG FINISHES:

- » 0605 Matte Black
- » 0705 Matte Cotton
- » 0788 Glossy Cotton
- » 0805 Oasis
- » 0905 Mint
- » 1005 Mercury
- » 1105 Canary
- » 1205 Stone
- » 1305 Sage
- » 1405 Ice Blue
- » 1505 Clay

LINEUP LOUNGE + MODULAR // DESIGNED BY IDA DESIGN

MODULAR ARRANGEMENTS:

- » Build configurations from left-to-right, as facing.
- » Units are comprised of pre-built 2 and 3-seat modules.
- » Starter units (-ST) represent the first seating model in a configuration, with subsequent modular units building from there.
- » Add-on units (-AO) can only be added next to starter units or other add-on units.
- » End units (-EU) represent the final seating model in a configuration.
- » Corner unit can only be used after any starter or add-on unit.
- » **Note: Please include layout drawings or sketch with order.**
- » Field-assembly required.

LOUNGE/MODULAR ORDERING REQUIREMENTS:

- » Model number
- » Leg finish
- » Upholstery selection
- » Options, as applicable

BOOTH:

- » Stand-alone booths available in small and large configurations, all at 5-panels high.
- » Small booth includes two love seats.
- » Large booth includes a two-seat starter, corner and three-seat end unit.
- » Canopy features wood frame and PET acoustical slats.
- » Vertical wood panels available only on large booth models.
- » Canopy frame and vertical panels available in ash veneer.
- » For Super Matte Sable Ash, premium wood finish upcharge applies. Refer to options section for pricing.
- » Please note that Alabaster Ash finish is not available on booth models.
- » For custom wood finishes, please add one-time upcharge of \$514 List per color per order.
- » Canopy features metal rods that will match the leg finish as standard.
- » Blanket-wrap shipping only.
- » Field-assembly required.

PET ACOUSTICAL SLAT COLORS:

- » Frost
- » Pewter
- » Slate

BOOTH ORDERING REQUIREMENTS:

- » Model number
- » Leg finish
- » Wood canopy frame finish
- » Acoustical slat color
- » Vertical wood slat finish, as applicable
- » Upholstery selection
- » Options, as applicable

LINEUP LOUNGE + MODULAR // DESIGNED BY IDA DESIGN

ORDERING REQUIREMENTS:

- » Model number
- » Metal leg finish
- » Upholstery selection
- » Options, as applicable

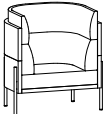
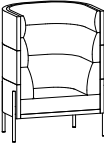
MODEL NUMBER	PRODUCT SPECIFICATIONS	FABRIC GRADES										LEATHER				
		COM	A	1	2	COL					3	4	5	6	7	8
8901-1P 	Lounge Chair 1 Panel & 1 Back Cushion W 39 ¹ / ₄ D 29 H 29 ³ / ₄ Seat Height 16 ³ / ₄ Inside Seat Width 22 Inside Seat Depth 20 ¹ / ₂ 6 yds. 76 lbs. COL 120 sq. ft.	3131	3521	3713	3833	4025	4235	4433	4631	4817	5039	5945	6635			
8901-2P 	Lounge Chair 2 Panels & 2 Back Cushions W 39 ¹ / ₄ D 29 H 41 ³ / ₄ Seat Height 16 ³ / ₄ Inside Seat Width 22 Inside Seat Depth 20 ¹ / ₂ 8 ³ / ₄ yds. 97 lbs. COL 175 sq. ft.	3846	4415	4695	4870	5150	5456	5745	6034	6305	6629	7950	8956			
8901-3P 	Lounge Chair 3 Panels & 3 Back Cushions W 39 ¹ / ₄ D 29 H 50 ⁵ / ₈ Seat Height 16 ³ / ₄ Inside Seat Width 22 Inside Seat Depth 20 ¹ / ₂ 10 yds. 115 lbs. COL 200 sq. ft.	4626	5276	5596	5796	6116	6466	6796	7126	7436	7806	9316	10466			

OPTIONS

-PFM01	Premium Metal Finish	78
--------	----------------------	----

LINEUP LOUNGE + MODULAR // DESIGNED BY IDA DESIGN

ORDERING REQUIREMENTS:

- » Model number
- » Metal leg finish
- » Upholstery selection
- » Options, as applicable

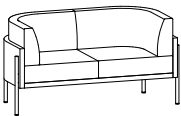
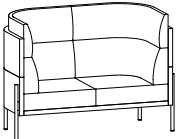
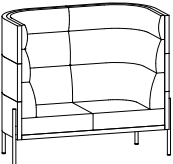
MODEL NUMBER	PRODUCT SPECIFICATIONS	FABRIC GRADES										LEATHER			
		COM	A	1	2	COL		3	4	5	6	7	8	L1	L2
8902-1P 	Love Seat 1 Panel & 1 Back Cushion W 59 ¹ / ₂ D 29 H 29 ³ / ₄ Seat Height 16 ³ / ₄ Inside Seat Width 48 Inside Seat Depth 20 ¹ / ₂ 8 ³ / ₄ yds. 103 lbs. COL 175 sq. ft.	4813	5382	5662	5837	6117	6423	6712	7001	7272	7596	8917	9923		
8902-2P 	Love Seat 2 Panels & 2 Back Cushions W 59 ¹ / ₂ D 29 H 41 ³ / ₄ Seat Height 16 ³ / ₄ Inside Seat Width 48 Inside Seat Depth 20 ¹ / ₂ 12 ¹ / ₄ yds. 140 lbs. COL 245 sq. ft.	5724	6521	6913	7158	7550	7978	8383	8787	9167	9620	11470	12878		
8902-3P 	Love Seat 3 Panels & 3 Back Cushions W 59 ¹ / ₂ D 29 H 50 ⁵ / ₈ Seat Height 16 ³ / ₄ Inside Seat Width 48 Inside Seat Depth 20 ¹ / ₂ 12 ¹ / ₂ yds. 177 lbs. COL 250 sq. ft.	6842	7655	8055	8305	8705	9142	9555	9967	10355	10817	12705	14142		

OPTIONS

-PFM01	Premium Metal Finish	78
--------	----------------------	----

LINEUP LOUNGE + MODULAR // DESIGNED BY IDA DESIGN

ORDERING REQUIREMENTS:

- » Model number
- » Metal leg finish
- » Upholstery selection
- » Options, as applicable

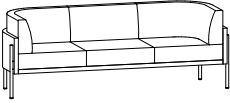
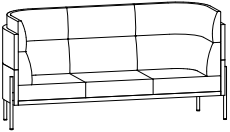
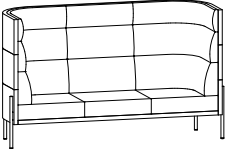
MODEL NUMBER	PRODUCT SPECIFICATIONS	FABRIC GRADES										LEATHER			
		COM	A	1	2	COL		3	4	5	6	7	8	L1	L2
8903-1P 	Sofa 1 Panel & 1 Back Cushion W 86 ¹ / ₂ D 29 H 29 ³ / ₄ Seat Height 16 ³ / ₄ Inside Seat Width 70 Inside Seat Depth 20 ¹ / ₂ 11 ³ / ₄ yds. 129 lbs. COL 235 sq. ft.	6334	7098	7474	7709	8085	8496	8884	9272	9636	10071	11845	13196		
8903-2P 	Sofa 2 Panels & 2 Back Cushions W 86 ¹ / ₂ D 29 H 41 ³ / ₄ Seat Height 16 ³ / ₄ Inside Seat Width 70 Inside Seat Depth 20 ¹ / ₂ 14 ¹ / ₄ yds. 171 lbs. COL 285 sq. ft.	7920	8847	9303	9588	10044	10542	11013	11483	11925	12452	14604	16242		
8903-3P 	Sofa 3 Panels & 3 Back Cushions W 86 ¹ / ₂ D 29 H 50 ⁵ / ₈ Seat Height 16 ³ / ₄ Inside Seat Width 70 Inside Seat Depth 20 ¹ / ₂ 15 ³ / ₄ yds. 214 lbs. COL 315 sq. ft.	9249	10273	10777	11092	11596	12147	12667	13187	13675	14258	16636	18447		
OPTIONS															
-PFM01	Premium Metal Finish														78

LINEUP LOUNGE + MODULAR // DESIGNED BY IDA DESIGN

ORDERING REQUIREMENTS:

- » Model number
- » Metal leg finish
- » Upholstery selection
- » Options, as applicable

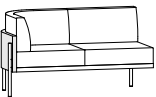
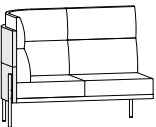
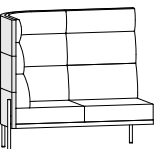
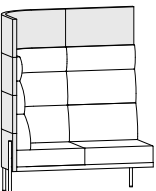
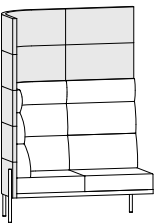
MODEL NUMBER	PRODUCT SPECIFICATIONS	FABRIC GRADES									
		COM	A	1	2	3	4	5	6	7	8
2-Seat Starter Units											
8932-ST-1P 	1 Panel & 1 Back Cushion W 55 ³ / ₈ D 29 H 29 ³ / ₄ Seat Height 16 ³ / ₄ Inside Seat Width 48 ¹ / ₂ Inside Seat Depth 20 ¹ / ₂ 7 ¹ / ₂ yds. 77 lbs.	4644	5132	5372	5522	5762	6024	6272	6519	6752	7029
8932-ST-2P 	2 Panels & 2 Back Cushions W 55 ³ / ₈ D 29 H 41 ³ / ₄ Seat Height 16 ³ / ₄ Inside Seat Width 48 ¹ / ₂ Inside Seat Depth 20 ¹ / ₂ 9 ¹ / ₄ yds. 109 lbs.	5569	6171	6467	6652	6948	7271	7577	7882	8169	8511
8932-ST-3P 	3 Panels & 3 Back Cushions W 55 ³ / ₈ D 29 H 50 ⁵ / ₈ Seat Height 16 ³ / ₄ Inside Seat Width 48 ¹ / ₂ Inside Seat Depth 20 ¹ / ₂ 11 ¹ / ₄ yds. 138 lbs.	6700	7432	7792	8017	8377	8770	9142	9513	9862	10278
8932-ST-4P 	4 Panels & 3 Back Cushions W 55 ³ / ₈ D 29 H 64 ³ / ₄ Seat Height 16 ³ / ₄ Inside Seat Width 48 ¹ / ₂ Inside Seat Depth 20 ¹ / ₂ 11 ³ / ₄ yds. 156 lbs.	7391	8155	8531	8766	9142	9553	9941	10329	10693	11128
8932-ST-5P 	5 Panels & 3 Back Cushions W 55 ³ / ₈ D 29 H 78 ³ / ₈ Seat Height 16 ³ / ₄ Inside Seat Width 48 ¹ / ₂ Inside Seat Depth 20 ¹ / ₂ 13 ³ / ₄ yds. 174 lbs.	8032	8926	9366	9641	10081	10562	11016	11470	11896	12405
OPTIONS											
-PFM01	Premium Metal Finish	78									

LINEUP LOUNGE + MODULAR // DESIGNED BY IDA DESIGN

ORDERING REQUIREMENTS:

- » Model number
- » Metal leg finish
- » Upholstery selection
- » Options, as applicable

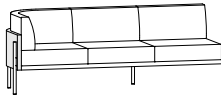
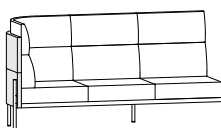
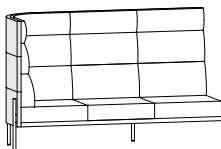
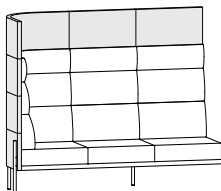
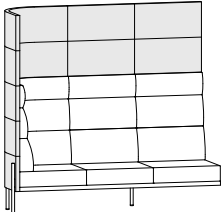
MODEL NUMBER	PRODUCT SPECIFICATIONS	FABRIC GRADES									
		COM	A	1	2	3	4	5	6	7	8
3-Seat Starter Units											
8933-ST-1P 	1 Panel & 1 Back Cushion W 82 ⁵ / ₈ D 29 H 29 ³ / ₄ Seat Height 16 ³ / ₄ Inside Seat Width 75 ¹ / ₂ Inside Seat Depth 20 ¹ / ₂ 9 ¹ / ₂ yds. 98 lbs.	6255	6873	7177	7367	7671	8003	8317	8630	8925	9276
8933-ST-2P 	2 Panels & 2 Back Cushions W 82 ⁵ / ₈ D 29 H 41 ³ / ₄ Seat Height 16 ³ / ₄ Inside Seat Width 75 ¹ / ₂ Inside Seat Depth 20 ¹ / ₂ 12 ¹ / ₂ yds. 134 lbs.	7548	8361	8761	9011	9411	9848	10261	10673	11061	11523
8933-ST-3P 	3 Panels & 3 Back Cushions W 82 ⁵ / ₈ D 29 H 50 ⁵ / ₈ Seat Height 16 ³ / ₄ Inside Seat Width 75 ¹ / ₂ Inside Seat Depth 20 ¹ / ₂ 14 yds. 186 lbs.	9107	10017	10465	10745	11193	11683	12145	12607	13041	13559
8933-ST-4P 	4 Panels & 3 Back Cushions W 82 ⁵ / ₈ D 29 H 64 ³ / ₄ Seat Height 16 ³ / ₄ Inside Seat Width 75 ¹ / ₂ Inside Seat Depth 20 ¹ / ₂ 16 ¹ / ₄ yds. 191 lbs.	10008	11065	11585	11910	12430	12998	13535	14071	14575	15176
8933-ST-5P 	5 Panels & 3 Back Cushions W 82 ⁵ / ₈ D 29 H 78 ³ / ₈ Seat Height 16 ³ / ₄ Inside Seat Width 75 ¹ / ₂ Inside Seat Depth 20 ¹ / ₂ 18 ¹ / ₂ yds. 214 lbs.	10827	12030	12622	12992	13584	14231	14842	15452	16026	16710

OPTIONS

-PFM01	Premium Metal Finish	78
--------	----------------------	----

LINEUP LOUNGE + MODULAR // DESIGNED BY IDA DESIGN

ORDERING REQUIREMENTS:

- » Model number
- » Metal leg finish
- » Upholstery selection
- » Options, as applicable

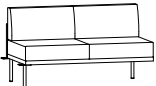
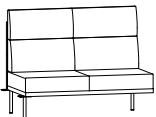
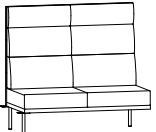
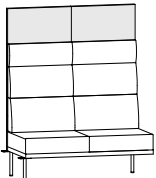
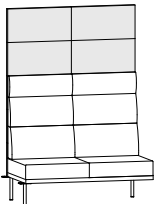
MODEL NUMBER	PRODUCT SPECIFICATIONS	FABRIC GRADES									
		COM	A	1	2	3	4	5	6	7	8
2-Seat Add-On Units											
8932-AO-1P	 <p>1 Panel & 1 Back Cushion W 54 D 29 H 29³/₄ Seat Height 16³/₄ Inside Seat Width 54 Inside Seat Depth 20¹/₂ 6³/₄ yds. 62 lbs.</p>	4618	5057	5273	5408	5624	5860	6083	6306	6515	6765
8932-AO-2P	 <p>2 Panels & 2 Back Cushions W 54 D 29 H 41³/₄ Seat Height 16³/₄ Inside Seat Width 54 Inside Seat Depth 20¹/₂ 8¹/₂ yds. 88 lbs.</p>	5509	6062	6334	6504	6776	7073	7354	7634	7898	8212
8932-AO-3P	 <p>3 Panels & 3 Back Cushions W 54 D 29 H 50⁵/₈ Seat Height 16³/₄ Inside Seat Width 54 Inside Seat Depth 20¹/₂ 9¹/₂ yds. 114 lbs.</p>	6603	7221	7525	7715	8019	8351	8665	8978	9273	9624
8932-AO-4P	 <p>4 Panels & 3 Back Cushions W 54 D 29 H 64³/₄ Seat Height 16³/₄ Inside Seat Width 54 Inside Seat Depth 20¹/₂ 10¹/₄ yds. 127 lbs.</p>	7286	7953	8281	8486	8814	9172	9511	9849	10167	10546
8932-AO-5P	 <p>5 Panels & 3 Back Cushions W 54 D 29 H 78³/₈ Seat Height 16³/₄ Inside Seat Width 54 Inside Seat Depth 20¹/₂ 11¹/₄ yds. 140 lbs.</p>	7922	8654	9014	9239	9599	9992	10364	10735	11084	11500
OPTIONS											
-PFM01	Premium Metal Finish	78									

LINEUP LOUNGE + MODULAR // DESIGNED BY IDA DESIGN

ORDERING REQUIREMENTS:

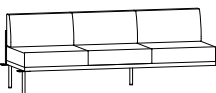
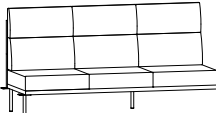
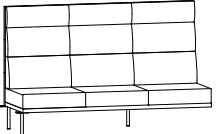
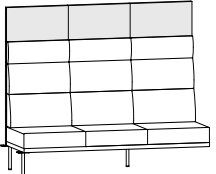
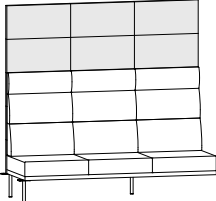

- » Model number
- » Metal leg finish
- » Upholstery selection
- » Options, as applicable

MODEL NUMBER	PRODUCT SPECIFICATIONS	FABRIC GRADES									
		COM	A	1	2	3	4	5	6	7	8
3-Seat Add-On Units											
8933-AO-1P 	1 Panel & 1 Back Cushion W 81 D 29 H 29 ³ / ₄ Seat Height 16 ³ / ₄ Inside Seat Width 81 Inside Seat Depth 20 ¹ / ₂ 10 yds. 83 lbs.	6230	6880	7200	7400	7720	8070	8400	8730	9040	9410
8933-AO-2P 	2 Panels & 2 Back Cushions W 81 D 29 H 41 ³ / ₄ Seat Height 16 ³ / ₄ Inside Seat Width 81 Inside Seat Depth 20 ¹ / ₂ 12 ¹ / ₄ yds. 122 lbs.	7486	8283	8675	8920	9312	9740	10145	10549	10929	11382
8933-AO-3P 	3 Panels & 3 Back Cushions W 81 D 29 H 50 ⁵ / ₈ Seat Height 16 ³ / ₄ Inside Seat Width 81 Inside Seat Depth 20 ¹ / ₂ 13 ¹ / ₄ yds. 161 lbs.	9009	9871	10295	10560	10984	11447	11885	12322	12733	13223
8933-AO-4P 	4 Panels & 3 Back Cushions W 81 D 29 H 64 ³ / ₄ Seat Height 16 ³ / ₄ Inside Seat Width 81 Inside Seat Depth 20 ¹ / ₂ 15 yds. 181 lbs.	9904	10879	11359	11659	12139	12664	13159	13654	14119	14674
8933-AO-5P 	5 Panels & 3 Back Cushions W 81 D 29 H 78 ³ / ₈ Seat Height 16 ³ / ₄ Inside Seat Width 81 Inside Seat Depth 20 ¹ / ₂ 16 ³ / ₄ yds. 201 lbs.	10913	12002	12538	12873	13409	13995	14548	15101	15620	16240
OPTIONS											
-PFM01	Premium Metal Finish	78									

LINEUP LOUNGE + MODULAR // DESIGNED BY IDA DESIGN

ORDERING REQUIREMENTS:

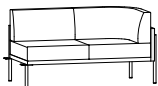
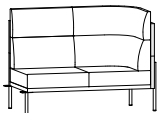
- » Model number
- » Metal leg finish
- » Upholstery selection
- » Options, as applicable

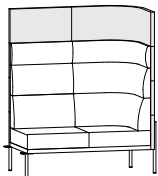
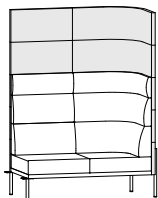
MODEL NUMBER	PRODUCT SPECIFICATIONS	FABRIC GRADES									
		COM	A	1	2	3	4	5	6	7	8
2-Seat End Units											
8932-EU-1P	1 Panel & 1 Back Cushion W 55 ³ / ₈ D 29 H 29 ³ / ₄ Seat Height 16 ³ / ₄ Inside Seat Width 48 ¹ / ₂ Inside Seat Depth 20 ¹ / ₂ 7 ¹ / ₂ yds. 77 lbs.	4759	5247	5487	5637	5877	6139	6387	6634	6867	7144
											
8932-EU-2P	2 Panels & 2 Back Cushions W 55 ³ / ₈ D 29 H 41 ³ / ₄ Seat Height 16 ³ / ₄ Inside Seat Width 48 ¹ / ₂ Inside Seat Depth 20 ¹ / ₂ 9 ¹ / ₄ yds. 109 lbs.	5685	6287	6583	6768	7064	7387	7693	7998	8285	8627
											
8932-EU-3P	3 Panels & 3 Back Cushions W 55 ³ / ₈ D 29 H 50 ⁵ / ₈ Seat Height 16 ³ / ₄ Inside Seat Width 48 ¹ / ₂ Inside Seat Depth 20 ¹ / ₂ 11 ¹ / ₄ yds. 138 lbs.	6818	7550	7910	8135	8495	8888	9260	9631	9980	10396
											
8932-EU-4P	4 Panels & 3 Back Cushions W 55 ³ / ₈ D 29 H 64 ³ / ₄ Seat Height 16 ³ / ₄ Inside Seat Width 48 ¹ / ₂ Inside Seat Depth 20 ¹ / ₂ 11 ³ / ₄ yds. 156 lbs.	7509	8273	8649	8884	9260	9671	10059	10447	10811	11246
											
8932-EU-5P	5 Panels & 3 Back Cushions W 55 ³ / ₈ D 29 H 78 ³ / ₈ Seat Height 16 ³ / ₄ Inside Seat Width 48 ¹ / ₂ Inside Seat Depth 20 ¹ / ₂ 13 ³ / ₄ yds. 174 lbs.	8151	9045	9485	9760	10200	10681	11135	11589	12015	12524
											

OPTIONS											
-PFM01	Premium Metal Finish	78									

LINEUP LOUNGE + MODULAR // DESIGNED BY IDA DESIGN

ORDERING REQUIREMENTS:

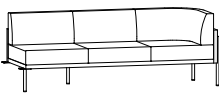
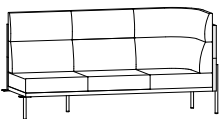
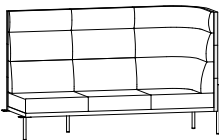
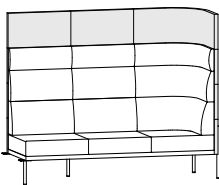
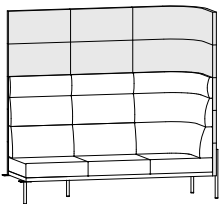

- » Model number
- » Metal leg finish
- » Upholstery selection
- » Options, as applicable

MODEL NUMBER	PRODUCT SPECIFICATIONS	FABRIC GRADES									
		COM	A	1	2	3	4	5	6	7	8
3-Seat End Units											
8933-EU-1P	 <p>1 Panel & 1 Back Cushion W 82⁵/₈ D 29 H 29³/₄ Seat Height 16³/₄ Inside Seat Width 75¹/₂ Inside Seat Depth 20¹/₂ 9¹/₂ yds. 98 lbs.</p>	6370	6988	7292	7482	7786	8118	8432	8745	9040	9391
8933-EU-2P	 <p>2 Panels & 2 Back Cushions W 82⁵/₈ D 29 H 41³/₄ Seat Height 16³/₄ Inside Seat Width 75¹/₂ Inside Seat Depth 20¹/₂ 12¹/₂ yds. 134 lbs.</p>	7663	8476	8876	9126	9526	9963	10376	10788	11176	11638
8933-EU-3P	 <p>3 Panels & 3 Back Cushions W 82⁵/₈ D 29 H 50⁵/₈ Seat Height 16³/₄ Inside Seat Width 75¹/₂ Inside Seat Depth 20¹/₂ 14 yds. 186 lbs.</p>	9226	10136	10584	10864	11312	11802	12264	12726	13160	13678
8933-EU-4P	 <p>4 Panels & 3 Back Cushions W 82⁵/₈ D 29 H 64³/₄ Seat Height 16³/₄ Inside Seat Width 75¹/₂ Inside Seat Depth 20¹/₂ 16¹/₄ yds. 191 lbs.</p>	10126	11183	11703	12028	12548	13116	13653	14189	14693	15294
8933-EU-5P	 <p>5 Panels & 3 Back Cushions W 82⁵/₈ D 29 H 78³/₈ Seat Height 16³/₄ Inside Seat Width 75¹/₂ Inside Seat Depth 20¹/₂ 22¹/₂ yds. 214 lbs.</p>	10945	12148	12740	13110	13702	14349	14960	15570	16144	16828
OPTIONS											
-PFM01	Premium Metal Finish	78									

LINEUP LOUNGE + MODULAR // DESIGNED BY IDA DESIGN

ORDERING REQUIREMENTS:

- » Model number
- » Metal leg finish
- » Upholstery selection
- » Options, as applicable

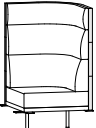
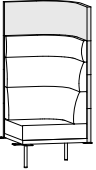
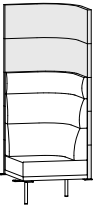
MODEL NUMBER	PRODUCT SPECIFICATIONS	FABRIC GRADES									
		COM	A	1	2	3	4	5	6	7	8
Corner Units											
8934-1P 	1 Panel & 1 Back Cushion W 28 ⁵ / ₈ D 28 ⁵ / ₈ H 29 ³ / ₄ Seat Height 16 ³ / ₄ Inside Seat Width 21 ¹ / ₂ Inside Seat Depth 21 ¹ / ₂ 5 ¹ / ₄ yds. 55 lbs.	2967	3309	3477	3582	3750	3933	4107	4280	4443	4637
8934-2P 	2 Panels & 2 Back Cushions W 28 ⁵ / ₈ D 28 ⁵ / ₈ H 41 ³ / ₄ Seat Height 16 ³ / ₄ Inside Seat Width 21 ¹ / ₂ Inside Seat Depth 21 ¹ / ₂ 6 ¹ / ₂ yds. 72 lbs.	3526	3949	4157	4287	4495	4722	4937	5151	5353	5593
8934-3P 	3 Panels & 3 Back Cushions W 28 ⁵ / ₈ D 28 ⁵ / ₈ H 50 ⁵ / ₈ Seat Height 16 ³ / ₄ Inside Seat Width 21 ¹ / ₂ Inside Seat Depth 21 ¹ / ₂ 8 yds. 89 lbs.	4226	4746	5002	5162	5418	5698	5962	6226	6474	6770
8934-4P 	4 Panels & 3 Back Cushions W 28 ⁵ / ₈ D 28 ⁵ / ₈ H 64 ³ / ₄ Seat Height 16 ³ / ₄ Inside Seat Width 21 ¹ / ₂ Inside Seat Depth 21 ¹ / ₂ 8 ¹ / ₂ yds. 100 lbs.	4706	5259	5531	5701	5973	6270	6551	6831	7095	7409
8934-5P 	5 Panels & 3 Back Cushions W 28 ⁵ / ₈ D 28 ⁵ / ₈ H 78 ³ / ₈ Seat Height 16 ³ / ₄ Inside Seat Width 21 ¹ / ₂ Inside Seat Depth 21 ¹ / ₂ 9 ¹ / ₂ yds. 111 lbs.	5103	5721	6025	6215	6519	6851	7165	7478	7773	8124
OPTIONS											
-PFM01	Premium Metal Finish	78									

LINEUP LOUNGE + MODULAR // DESIGNED BY IDA DESIGN

ORDERING REQUIREMENTS:

- » Model number
- » Metal leg finish
- » Wood canopy frame finish
- » Acoustical slat color
- » Vertical wood slat finish, as applicable
- » Upholstery selection
- » Options, as applicable

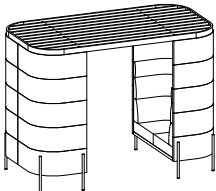
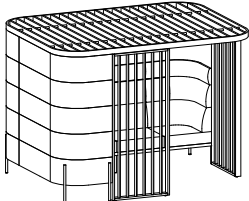
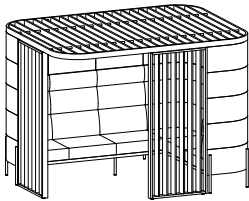
MODEL NUMBER	PRODUCT SPECIFICATIONS	FABRIC GRADES									
		COM	A	1	2	3	4	5	6	7	8
Booth Units											
8911-22	 <p>Small Booth Configuration, Wood Canopy Frame with Acoustical Slats W 109 D 59¹/₂ H 81³/₈ Seat Height 16³/₄ Inside Seat Width 48¹/₂ Inside Seat Depth 20¹/₂ 35 yds. 450 lbs.</p>	19991	22266	23386	24086	25206	26431	27586	28741	29826	31121
8911-43R	 <p>Large Booth Configuration, Right, Vertical Wood Slats, Wood Canopy Frame with Acoustical Slats W 112¹/₂ D 86¹/₂ H 81³/₈ Seat Height 16³/₄ Inside Seat Width 96³/₄ Inside Seat Depth 20¹/₂ 37³/₄ yds. 680 lbs.</p>	34591	37045	38253	39008	40216	41537	42783	44029	45199	46596
8911-43L	 <p>Large Booth Configuration, Left, Vertical Wood Slats, Wood Canopy Frame with Acoustical Slats W 112¹/₂ D 86¹/₂ H 81³/₈ Seat Height 16³/₄ Inside Seat Width 96³/₄ Inside Seat Depth 20¹/₂ 37³/₄ yds. 680 lbs.</p>	34591	37045	38253	39008	40216	41537	42783	44029	45199	46596

OPTIONS		
-PFW05	Premium Wood Finish, Canopy Frame	83
-PFW06	Premium Wood Finish, Canopy Frame/Vertical Slats	300
-PFM03	Premium Metal Leg Finish	152

LINEUP LOUNGE + MODULAR // DESIGNED BY IDA DESIGN

CONFIGURATION EXAMPLES:

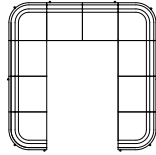
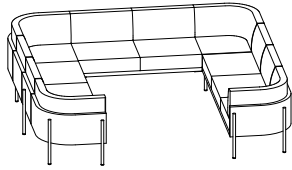

Qty	Model #	Description (Left-to-Right as Facing)	COM List
1	8933-ST-1P	Three-Seat Starter Unit, 1 Panel/Cushion	\$6,255
2	8934-1P	Corner Unit, 1 Panel/Cushion (\$2,967 each)	\$5,934
1	8932-AO-1P	2-Seat Add-On Unit, 1 Panel/Cushion	\$4,618
1	8933-EU-1P	Three-Seat End Unit, 1 Panel/Cushion	\$6,370
5			\$23,177

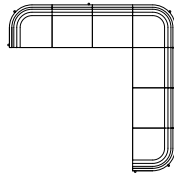
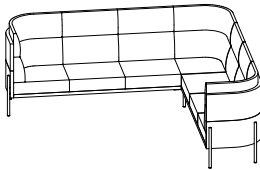

Qty	Model #	Description (Left-to-Right as Facing)	COM List
1	8933-ST-2P	Three-Seat Starter Unit, 2 Panels/Cushions	\$7,548
1	8934-2P	Corner Unit, 2 Panels/Cushions	\$3,526
1	8933-EU-2P	Three-Seat End Unit, 2 Panels/Cushions	\$7,663
4			\$18,737

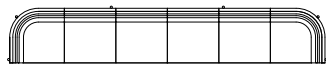
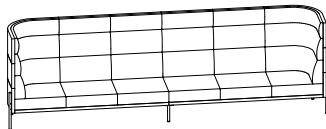

Qty	Model #	Description (Left-to-Right as Facing)	COM List
1	8933-ST-3P	Three-Seat Starter Unit, 3 Panels/Cushions	\$9,107
1	8933-EU-3P	Three-Seat End Unit, 3 Panels/Cushions	\$9,226
2			\$18,333

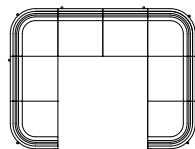
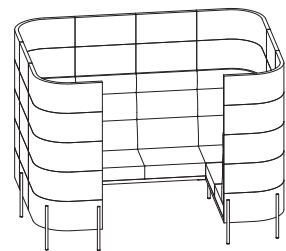

Qty	Model #	Description (Left-to-Right as Facing)	COM List
1	8932-ST-5P	Two-Seat Starter Unit, 5 Panels/Cushions	\$8,032
2	8934-5P	Corner Unit, 5 Panels/Cushions (\$5,103 each)	\$10,206
1	8932-AO-5P	Two-Seat Add-On Unit, 5 Panels/Cushions	\$7,922
1	8932-EU-5P	Two-Seat End Unit, 5 Panels/Cushions	\$8,151
5			\$34,311

LINEUP LOUNGE + MODULAR // DESIGNED BY IDA DESIGN

POWER UNITS:

- » Power unit model number should follow applicable seating model number.
- » Optional power units can be mounted anywhere below the seating units for maximum convenience. Mounting hardware included for in-field attachment.

Note: No hardwire option available for this series.

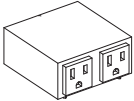
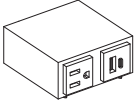
MODEL NUMBER	PRODUCT SPECIFICATIONS	LIST
<p>(-)-USB3-B (BLACK FINISH)</p> 	<p>USB Charging Dock 3</p> <ul style="list-style-type: none"> » Dimensions: 2¹/₂" W x 1¹/₂" D x 3³/₄" H » Black finish » One (1) USB-A and one (1) USB-C charging ports with blue LED back lighting » 96" electrical cord (only length available) » UL listed 	<p>179</p>
<p>(-)-MT2-B (BLACK FINISH) (-)-MT2-W (WHITE FINISH)</p> 	<p>Mini-Tap 2</p> <ul style="list-style-type: none"> » Dimensions: 3" W x 3" D x 1³/₄" H » Black or white finish » Two (2) simplex outlets » 72" electrical cord (only length available) 	<p>367</p>
<p>(-)-MT3-B (BLACK FINISH) (-)-MT3-W (WHITE FINISH)</p> 	<p>Mini-Tap 3</p> <ul style="list-style-type: none"> » Dimensions: 3" W x 3" D x 1³/₄" H » Black or white finish » One (1) simplex outlet, one (1) USB-A and one (1) USB-C charging port » 72" electrical cord (only length available) » UL listed 	<p>399</p>





PILLOWS (also featured in the Uptown Social Collection)

ORDERING REQUIREMENTS:

- » Model number
- » Upholstery selection

Note: Pillows are upholstered on both sides, with concealed zipper enclosure.

Note: Vinyl, polyurethane and leather upholstery not available.

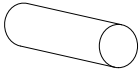
MODEL NUMBER	PRODUCT SPECIFICATIONS	FABRIC GRADES									
		COM	A	1	2	3	4	5	6	7	8
5118-1616 	16" Square Pillow W 16 D 3 H 16 3/4 yd. 1 lb.	172	221	245	260	284	310	335	360	383	411
5118-1818 	18" Square Pillow W 18 D 3 H 18 3/4 yd. 1 lb.	178	227	251	266	290	316	341	366	389	417
5118-2020 	20" Square Pillow W 20 D 3 H 20 3/4 yd. 1 lb.	188	237	261	276	300	326	351	376	399	427
5118-1018 	10" x 18" Rectangle Pillow W 18 D 3 H 10 1/2 yd. 1 lb.	176	209	225	235	251	268	285	301	317	335
5119 	6" x 18" Bolster Pillow Dia. 6 L 18 3/4 yd. 1 lb.	223	272	296	311	335	361	386	411	434	462

LINEUP LOUNGE + MODULAR // DESIGNED BY IDA DESIGN

UPHOLSTERY COMBINATIONS:

- » Two-tone upholstery examples and yardage requirements for the most common combination is listed below. Please refer to the Lineup fabric calculator located on the Arcadia website to determine applicable upcharges.
- » For multiple seating models, please contact client services for assistance with exact yardage requirements.
- » Leather not available on modular seating units.
- » Note: Yardage amounts are based on fabric which is plain (i.e. non-directional/non-patterned) and a full 54" wide.



Code LU1

Model COM Requirement
8901-1P Inside/Outside Panel = 2 yds.
Balance of Unit = 4 yds.

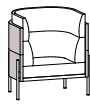

Code LU2

Model COM Requirement
8901-2P Inside/Outside Panel = $3\frac{1}{4}$ yds.
Balance of Unit = $5\frac{1}{2}$ yds.

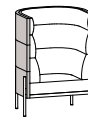

Code LU3

Model COM Requirement
8901-3P Inside/Outside Panel = $4\frac{1}{2}$ yds.
Balance of Unit = $5\frac{1}{2}$ yds.



Code LU4

Model COM Requirement
8902-1P Inside/Outside Panel = $3\frac{1}{4}$ yds.
Balance of Unit = $5\frac{1}{2}$ yds.

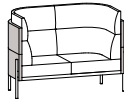

Code LU5

Model COM Requirement
8902-2P Inside/Outside Panel = 5 yds.
Balance of Unit = $7\frac{1}{4}$ yds.



Code LU6

Model COM Requirement
8902-3P Inside/Outside Panel = $5\frac{1}{4}$ yds.
Balance of Unit = $7\frac{1}{4}$ yds.

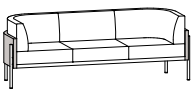

Code LU7

Model COM Requirement
8903-1P Inside/Outside Panel = 4 yds.
Balance of Unit = $7\frac{3}{4}$ yds.

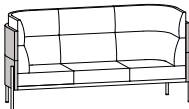

Code LU8

Model COM Requirement
8903-2P Inside/Outside Panel = $5\frac{1}{4}$ yds.
Balance of Unit = 9 yds.

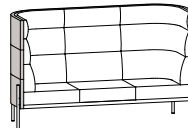

Code LU9

Model COM Requirement
8903-3P Inside/Outside Panel = 6 yds.
Balance of Unit = $9\frac{3}{4}$ yds.

LINEUP LOUNGE + MODULAR // DESIGNED BY IDA DESIGN

UPHOLSTERY COMBINATIONS:

- » Two-tone upholstery examples and yardage requirements for the most common combination is listed below. Please refer to the Lineup fabric calculator located on the Arcadia website to determine applicable upcharges.
- » For multiple seating models, please contact client services for assistance with exact yardage requirements.
- » Leather not available on modular seating units.
- » Note: Yardage amounts are based on fabric which is plain (i.e. non-directional/non-patterned) and a full 54" wide.

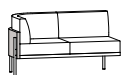

Code LU10
Model COM Requirement
 8932-ST-1P Inside/Outside Panel = 1³/₄ yds.
 8932-EU-1P Balance of Unit = 5³/₄ yds.

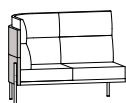

Code LU11
Model COM Requirement
 8932-ST-2P Inside/Outside Panel = 2³/₄ yds.
 8932-EU-2P Balance of Unit = 6¹/₂ yds.



Code LU12
Model COM Requirement
 8932-ST-3P Inside/Outside Panel = 4¹/₂ yds.
 8932-EU-3P Balance of Unit = 6³/₄ yds.

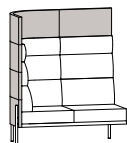

Code LU13
Model COM Requirement
 8932-ST-4P Inside/Outside Panel = 5 yds.
 8932-EU-4P Balance of Unit = 6³/₄ yds.

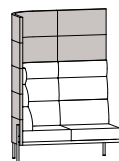

Code LU14
Model COM Requirement
 8932-ST-5P Inside/Outside Panel = 7 yds.
 8932-EU-5P Balance of Unit = 6³/₄ yds.

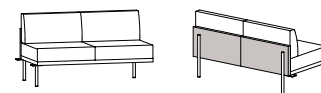

Code LU15
Model COM Requirement
 8932-AO-1P Inside/Outside Panel = 1¹/₂ yds.
 Balance of Unit = 5¹/₄ yds.

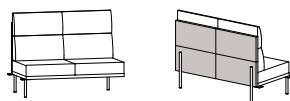

Code LU16
Model COM Requirement
 8932-AO-2P Inside/Outside Panel = 2 yds.
 Balance of Unit = 6¹/₂ yds.

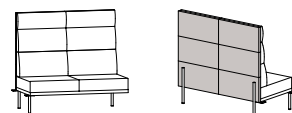

Code LU17
Model COM Requirement
 8932-AO-3P Inside/Outside Panel = 3 yds.
 Balance of Unit = 6¹/₂ yds.

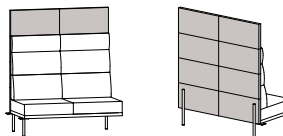

Code LU18
Model COM Requirement
 8932-AO-4P Inside/Outside Panel = 3³/₄ yds.
 Balance of Unit = 6¹/₂ yds.

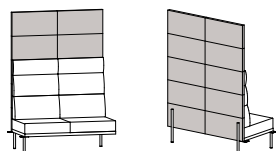

Code LU19
Model COM Requirement
 8932-AO-5P Inside/Outside Panel = 4³/₄ yds.
 Balance of Unit = 6¹/₂ yds.

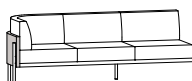

Code LU20
Model COM Requirement
 8933-ST-1P Inside/Outside Panel = 2¹/₄ yds.
 8933-EU-1P Balance of Unit = 7¹/₄ yds.

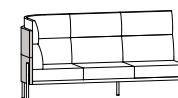

Code LU21
Model COM Requirement
 8933-ST-2P Inside/Outside Panel = 3¹/₂ yds.
 8933-EU-2P Balance of Unit = 9 yds.

LINEUP LOUNGE + MODULAR // DESIGNED BY IDA DESIGN

UPHOLSTERY COMBINATIONS:

- » Two-tone upholstery examples and yardage requirements for the most common combination is listed below. Please refer to the Lineup fabric calculator located on the Arcadia website to determine applicable upcharges.
- » For multiple seating models, please contact client services for assistance with exact yardage requirements.
- » Leather not available on modular seating units.
- » Note: Yardage amounts are based on fabric which is plain (i.e. non-directional/non-patterned) and a full 54" wide.

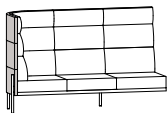

Code LU22
Model COM Requirement
 8933-ST-3P Inside/Outside Panel = 4³/₄ yds.
 8933-EU-3P Balance of Unit = 10¹/₂ yds.

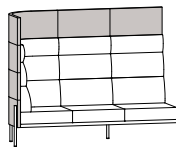

Code LU23
Model COM Requirement
 8933-ST-4P Inside/Outside Panel = 7 yds.
 8933-EU-4P Balance of Unit = 9¹/₄ yds.

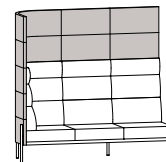

Code LU24
Model COM Requirement
 8933-ST-5P Inside/Outside Panel = 9¹/₄ yds.
 8933-EU-5P Balance of Unit = 9¹/₄ yds.

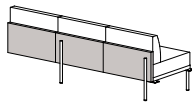
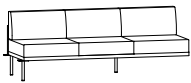

Code LU25
Model COM Requirement
 8933-AO-1P Inside/Outside Panel = 2 yds.
 Balance of Unit = 8 yds.

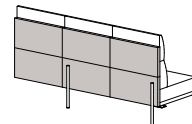
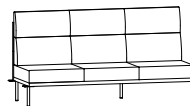

Code LU26
Model COM Requirement
 8933-AO-2P Inside/Outside Panel = 3 yds.
 Balance of Unit = 9¹/₄ yds.

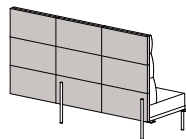
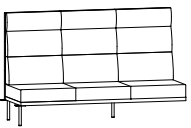

Code LU27
Model COM Requirement
 8933-AO-3P Inside/Outside Panel = 3³/₄ yds.
 Balance of Unit = 9¹/₂ yds.

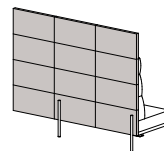
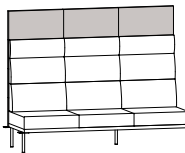

Code LU28
Model COM Requirement
 8933-AO-4P Inside/Outside Panel = 5¹/₂ yds.
 Balance of Unit = 9¹/₂ yds.

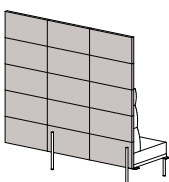
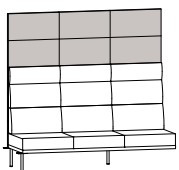

Code LU29
Model COM Requirement
 8933-AO-5P Inside/Outside Panel = 7¹/₄ yds.
 Balance of Unit = 9¹/₂ yds.

LINEUP LOUNGE + MODULAR // DESIGNED BY IDA DESIGN

UPHOLSTERY COMBINATIONS:

- » Two-tone upholstery examples and yardage requirements for the most common combination is listed below. Please refer to the Lineup fabric calculator located on the Arcadia website to determine applicable upcharges.
- » For multiple seating models, please contact client services for assistance with exact yardage requirements.
- » Leather not available on modular seating units.
- » Note: Yardage amounts are based on fabric which is plain (i.e. non-directional/non-patterned) and a full 54" wide.



Code LU30
Model 8934-1P
COM Requirement
 Inside/Outside Panel = 2 yds.
 Balance of Unit = 3¹/₄ yds.



Code LU31
Model 8934-2P
COM Requirement
 Inside/Outside Panel = 2 yds.
 Balance of Unit = 4¹/₂ yds.



Code LU32
Model 8934-3P
COM Requirement
 Inside/Outside Panel = 3¹/₂ yds.
 Balance of Unit = 4¹/₂ yds.

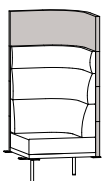

Code LU33
Model 8934-4P
COM Requirement
 Inside/Outside Panel = 4 yds.
 Balance of Unit = 4¹/₂ yds.

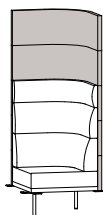

Code LU34
Model 8934-5P
COM Requirement
 Inside/Outside Panel = 5 yds.
 Balance of Unit = 4¹/₂ yds.

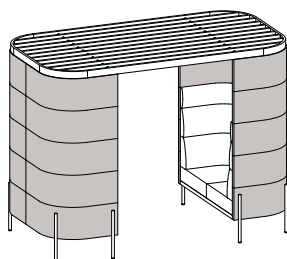

Code LU35
Model 8911-22
COM Requirement
 Inside/Outside Panel = 22 yds.
 Balance of Unit = 13 yds.

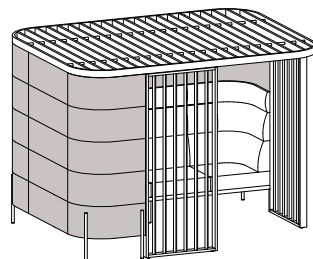

Code LU36
Model 8911-43R
COM Requirement
 Inside/Outside Panel = 19¹/₄ yds.
 Balance of Unit = 18¹/₂ yds.

NIOS TABLES



arcadia

MARCH 1, 2026
VA IDIQ CONTRACT (FY26)
(DEALER HELD)

NIOS® OCCASIONAL TABLES // DESIGNED BY 5D STUDIO



PRODUCT FEATURES:

- » Round and arc-square top shapes.
- » 15" table height. Custom heights below 15" available, please specify and add \$253 List upcharge per unit.
- » Table column diameter: 2 1/4".
- » Base standard with adjustable glides and facilitates wire management for through-the-surface electrical and/or data capability.
- » All dimensions are nominal.

SPECIFICATIONS:

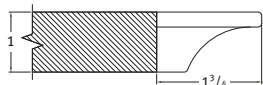

Veneer Top/Wood Edge

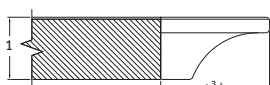

Laminate/Fenix Top/Exposed Wood Edge

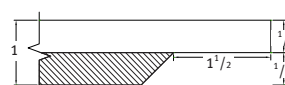

Corian Top/Exposed Wood Edge

- » Five table surface options: veneer, laminate, Fenix, Corian or back-painted glass.
- » Veneer offered in maple, walnut and white oak wood species.
- » All standard and custom wood finishes available.
- » Premium wood finish upcharge applies to the following wood finishes. Refer to options section for pricing.
 - Super Matte Sable Maple
 - Alabaster Oak
 - Super Matte Sable Oak
- » For custom wood finishes, please add one-time upcharge of \$514 List per color per order.
- » Laminate tops available in all standard laminates.
- » For custom laminates, add \$642 List per color per order. Pre-approval required, please contact client services.
- » Glass is back-painted white as standard and may be used as a writable surface with dry-erase markers.
- » Fenix offered in five standard colorways.
- » Refer to Terms and Conditions for edge finish details.
- » For non-standard Fenix, Corian or back-painted glass colors, please contact client services for pricing.
- » Metal pedestal base manufactured in aluminum and offered in standard as well as premium finish selections.

NIOS® OCCASIONAL TABLES // DESIGNED BY 5D STUDIO

CORIAN® COLORS

- » CWN Designer White
- » CLN Linen
- » CTD Witch Hazel
- » CRC Rain Cloud
- » CGQ Grey Onyx
- » CSQ Stonique

FENIX COLORS:

- » FJ0032 Bianco Kos
- » FJ0720 Nero Ingo
- » FJ0725 Grigio Efeso
- » FJ0718 Grigio Londra
- » FJ0724 Grigio Bromo

STANDARD METAL BASE FINISHES:

- » 0299 Polished Aluminum
- » 0405 Charcoal Grey
- » 0535 Metallic Silver
- » 0630 Satin Black

PREMIUM METAL BASE FINISHES:

- » 0605 Matte Black
- » 0705 Matte Cotton
- » 0788 Glossy Cotton
- » 0805 Oasis
- » 0905 Mint
- » 1005 Mercury
- » 1105 Canary
- » 1205 Stone
- » 1305 Sage
- » 1405 Ice Blue
- » 1505 Clay

POWER UNITS:

- » Available on all table sizes and heights.
- » Touch latch lid provides easy access to data and electrical features.
- » Metallic silver finish with 72" electrical cord (no hardwire option available for this series).
- » UL listed.

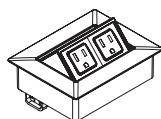

PP2
5¹/₄" W x 4¹/₄" L
Two outlets

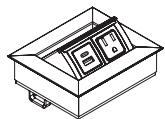

PP3
5¹/₄" W x 4¹/₄" L
One outlet, one USB-A and one USB-C charging port



ORDERING REQUIREMENTS:

- » Model number
- » Wood species, as applicable
- » Wood finish, as applicable
- » Metal base finish
- » Options, as applicable

NIOS® OCCASIONAL TABLES // DESIGNED BY 5D STUDIO

ORDERING REQUIREMENTS:

- » Model number
- » Wood species, as applicable
- » Table top finish
- » Edge finish, as applicable
- » Metal base finish
- » Options, as applicable

		MODEL NUMBER	VENEER OR LAMINATE	FENIX (-FE)	CORIAN (-CO)	BACK-PAINTED GLASS (-PG)	WEIGHT <small>(Veneer/Laminate Top)</small>
251 	Arc-Square Top, 15" Height						
	20" W x 20" L x 15" H	251-202015	1457	1582	2109	1895	18
	24" W x 24" L x 15" H	251-242415	1617	1797	2502	2211	24
	30" W x 30" L x 15" H	251-303015	2091	2371	3406	2771	32
	36" W x 36" L x 15" H	251-363615	2570	2974	4669	3317	42
	42" W x 42" L x 15" H	251-424215	2952	2359	5769	3787	53
	Arc-Rectangle Top, 15" Height						
	42" W x 24" L x 15" H	251-422415	2045	2359	3506	2725	35
	48" W x 28" L x 15" H	251-482815	2675	3094	4707	3404	43
252 	Round Top, 15" Height						
	20" Dia. x 15" H	252-2015	1598	1723	2251	2036	18
	24" Dia. x 15" H	252-2415	1778	1958	2662	2373	24
	30" Dia. x 15" H	252-3015	2298	2578	3611	2980	32
	36" Dia. x 15" H	252-3615	2828	3232	4919	3574	42
	42" Dia. x 15" H	252-4215	3248	3797	6058	4081	53

OPTIONS

-PFM03	Premium Metal Finish	152
-PFW04	Premium Wood Finish	44
-NS04	Non-Skid Glides	29
-PP2	Portal Power 2 (Dual Power)	730
-PP3	Portal Power 3 (1 Power, 2 USB)	862
-PC01	Glass Top Electrical Unit Cut-Out	87

☉ = Available on quick-ship program, models #251-202015, #251-242415, #251-303015 and #251-363615 (polished aluminum or metallic silver base finishes only).

OVATE TABLES

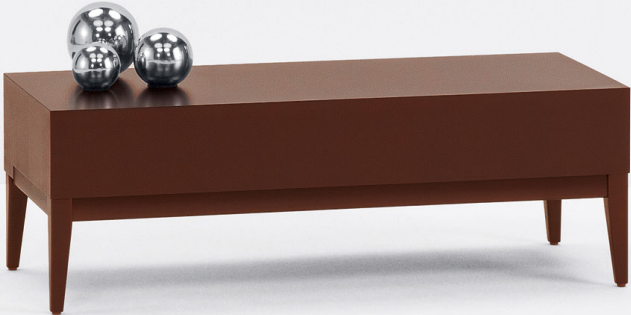

OVATE® OCCASIONAL TABLES // DESIGNED BY CHRIS PANICHELLA



PRODUCT FEATURES/SPECIFICATIONS:

- » Tables manufactured in beech, walnut and white oak.
- » All tables feature veneer tops as standard. Laminate and Corian tops available.
- » All standard wood finishes available on beech, walnut and white oak.
- » Premium wood finish upcharge applies to the following wood finishes. Refer to options section for pricing.
 - Super Matte Sable Beech
 - Alabaster Oak
 - Super Matte Sable Oak
- » For custom wood finishes, please add one-time upcharge of \$514 List per color per order.
- » For custom laminates, add \$642 List per color per order. Pre-approval required, please contact client services.
- » For Corian top, specify “-CO” next to model number. Corian top is affixed to table top surface increasing overall table height by 1/2". For non-standard colors, please contact client services for pricing.
- » **Table with laminate or Corian top, finish selection for table body must be specified.**
- » Platform base features 7" height clearance for floor maintenance ease. Base will match body finish as standard, unless otherwise specified.
- » Custom sizes available, contact client services for pricing.
- » All dimensions are nominal.

CORIAN® COLORS:

- » CWN Designer White
- » CLN Linen
- » CTD Witch Hazel
- » CRC Rain Cloud
- » CGQ Grey Onyx
- » CSQ Stonique

OVATE® OCCASIONAL TABLES // DESIGNED BY CHRIS PANICHELLA

POWER UNITS:

- » Placement will be in the center of tops, unless otherwise specified.
- » Black or white finish with 120" electrical cord (no hardwire option available for this series).
- » UL listed.

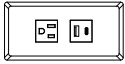

PX3
5⁷/₈" W x 2⁷/₈" D
One outlet, one USB-A and one USB-C charging port

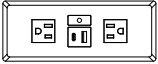

PX4
7¹/₄" W x 2⁷/₈" D
Two outlets, one USB-A and one USB-C charging port

ORDERING REQUIREMENTS:



- » Model number
- » Wood species
- » Wood finish
- » Options, as applicable

OVATE® OCCASIONAL TABLES // DESIGNED BY CHRIS PANICHELLA

ORDERING REQUIREMENTS:

- » Model number
- » Wood species
- » Wood finish
- » Options, as applicable

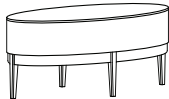
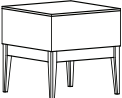
Note: Table with laminate or Corian top, finish selection for table body must be specified.

		MODEL NUMBER	VENEER OR LAMINATE	CORIAN (-CO)	WEIGHT (Veneer/Laminate Top)
536 	Ovate Round/Oval Table				
	22" Dia. x 16" H	536-2216	1928	2703	25
	22" Dia. x 20" H	536-2220	2021	2794	32
	30" Dia. x 16" H	536-3016	2675	3897	47
	36" Dia. x 16" H	536-3616	3302	5341	58
	44" W x 22" L x 16" H	536-442216	2696	4272	49
537 	Ovate Square/Rectangle Table				
	22" W x 22" L x 16" H	537-222216	1834	2614	37
	22" W x 22" L x 20" H	537-222220	1907	2684	39
	30" W x 30" L x 16" H	537-303016	2435	3662	55
	36" W x 36" L x 16" H	537-363616	2792	4843	64
	48" W x 20" L x 16" H	537-482016	2679	4256	60

OPTIONS

-PFW04	Premium Wood Finish	44
-NS04	Non-Skid Glides	29
-PX3-()	Power Matrix 3 (one power, one USB-A, one USB-C)	514
-PX4-()	Power Matrix 4 (dual power, one USB-A, one USB-C)	538

Note: For power matrix faceplate, please specify black (-B) or white (-W) finish.

REPRISE METAL SEATING



arcadia

MARCH 1, 2026
VA IDIQ CONTRACT (FY26)
(DEALER HELD)

REPRISE METAL GUEST + TANDEM // DESIGNED BY DAVID DAHL



PRODUCT FEATURES:

- » All models feature clean-outs on all sides, including between seat and back, for maintenance ease.
- » Radiused arm caps for smooth surface contact.
- » Wall-saver leg design.
- » Field-replaceable components available, refer to pages 17-19.
- » Optional replaceable seat upholstery available on all units.
- » Replacement seat and back covers (excluding patient chair) can be easily field-installed on previously ordered Reprise Metal models with standard fixed upholstery. Contact client services for instructions.
- » All dimensions are nominal.

TANDEM + MODULAR FEATURES:

- » To build tandem configurations, always specify units from left-to-right, as facing.
- » Available in two and three-seat combinations or as reconfigurable modular units.
- » Inline connecting tables available in 15" and 21" widths, with beech veneer, laminate or Corian tops. Custom sizes available, contact client services for pricing.
- » **Please include layout drawings or sketch with each order.**
- » Arcadia will pre-assemble units at the factory to maximize shipping allowances and minimize field assembly.

SPECIFICATIONS:

- » Frame comprised of glass-reinforced nylon arm and metal leg.
- » Nylon arm offered in two colors: black and grey.
- » Four arm cap options: beech wood, black urethane, grey urethane and Corian.
- » Metal frame standard with 0535 Metallic Silver finish. Other colors available, refer to individual pages for option code and upcharge.
- » For Corian arm caps, please specify '-CO' in place of the '-W' after model number with color selection and refer to options for upcharge.
- » Wood arm caps, as well as veneer connecting tables, available in all standard and custom wood finishes on beech.
- » For Super Matte Sable Beech, premium wood finish upcharge applies. Refer to options section for pricing.
- » For custom wood finishes to arm caps and/or inline table, please add one-time upcharge of \$514 List per color per order.
- » For custom laminates (applies to connecting tables only), add \$642 List per color per order. Pre-approval required, please contact client services.
- » Corian arm caps and inline tables available in six standard colors. For non-standard colors, please contact client services for pricing.

REPRISE METAL GUEST + TANDEM // DESIGNED BY DAVID DAHL

ALTERNATE METAL LEG FINISHES (UPCHARGE APPLIES):

- » 0405 Charcoal Grey
- » 0605 Matte Black
- » 0630 Satin Black
- » 0705 Matte Cotton
- » 0788 Glossy Cotton
- » 0805 Oasis
- » 0905 Mint
- » 1005 Mercury
- » 1105 Canary
- » 1205 Stone
- » 1305 Sage
- » 1405 Ice Blue
- » 1505 Clay

CORIAN® COLORS:

- » CWN Designer White
- » CLN Linen
- » CTD Witch Hazel
- » CRC Rain Cloud
- » CGQ Grey Onyx
- » CSQ Stonique

WEIGHT CAPACITY:

- » Guest Chair 350 lbs.
- » Preconfigured Tandem 350 lbs. per seat
- » Reconfigurable Tandem 350 lbs. per seat
- » Bariatric Chairs 750 lbs.
- » Patient Chair 350 lbs.
- » Easy Access/Hip Chair 350 lbs.



ORDERING REQUIREMENTS:

- » Model number
- » Nylon arm color
- » Arm cap selection and finish
- » Upholstery selection
- » Options, as applicable

REPRISE METAL GUEST + TANDEM // DESIGNED BY DAVID DAHL

ORDERING REQUIREMENTS:

- » Model number
- » Nylon arm color
- » Arm cap selection and finish
- » Upholstery selection
- » Options, as applicable

MODEL NUMBER	PRODUCT SPECIFICATIONS	FABRIC GRADES										LEATHER	
		COM	A	1	2	COL		3	4	5	6	7	8
M3410-(-)-UB (BLACK) M3410-(-)-UG (GREY) 	Single Guest Chair Urethane Arm Caps W 24 ¹ / ₂ D 25 ¹ / ₂ H 33 ¹ / ₂ Seat Height 18 Inside Seat Width 20 Inside Seat Depth 19 Arm Height 25 ¹ / ₂ 1 ¹ / ₂ yds. 37 lbs. COL 30 sq. ft.	1780	1878	1926	1956	2004	2056	2106	2155	2202	2257	2484	2656
M3410-2-(-)-UB (BLACK) M3410-2-(-)-UG (GREY) 	Two-Seat Tandem Urethane Arm Caps W 47 D 25 ¹ / ₂ H 33 ¹ / ₂ Seat Height 18 Inside Seat Width 20 Inside Seat Depth 19 Arm Height 25 ¹ / ₂ 3 yds. 66 lbs. COL 60 sq. ft.	3230	3425	3521	3581	3677	3782	3881	3980	4073	4184	4637	4982
M3410-3-(-)-UB (BLACK) M3410-3-(-)-UG (GREY) 	Three-Seat Tandem Urethane Arm Caps W 70 D 25 ¹ / ₂ H 33 ¹ / ₂ Seat Height 18 Inside Seat Width 20 Inside Seat Depth 19 Arm Height 25 ¹ / ₂ 4 ¹ / ₂ yds. 97 lbs. COL 90 sq. ft.	4688	4981	5125	5215	5359	5516	5665	5813	5953	6119	6799	7316
Specify Nylon Arm Color Black (-BN) Grey (-GN)													

OPTIONS



-SC01	Replaceable Seat Cover (per seat)	64
-BC01	Replaceable Back Cover (per back)	42
-MB01	Moisture Barrier (seat only, per seat)	69
-PFM01	Alternate Metal Leg Finish (per arm frame)	78
-NS02	Non-Skid Glides (per arm frame)	15

REPRISE METAL GUEST + TANDEM // DESIGNED BY DAVID DAHL

ORDERING REQUIREMENTS:

- » Model number
- » Nylon arm color
- » Arm cap selection and finish
- » Upholstery selection
- » Options, as applicable

Note: For Corian arm caps, specify '-CO' in place of '-W' after model number and refer to options below for upcharge.

MODEL NUMBER	PRODUCT SPECIFICATIONS	FABRIC GRADES										LEATHER			
		COM	A	1	2	COL		3	4	5	6	7	8	L1	L2
M3440-(-)W	 <p>Bariatric Chair, 34" Wide Wood Arm Caps W 34 D 25¹/₂ H 33¹/₂ Seat Height 18 Inside Seat Width 30 Inside Seat Depth 19 Arm Height 25¹/₂ 2¹/₂ yds. 48 lbs. COL 50 sq. ft.</p>	2000	2163	2243	2293	2373	2460	2543	2625	2703	2795	3173	3460		
M3445-(-)W	 <p>Bariatric Chair, 40" Wide Wood Arm Caps W 40 D 25¹/₂ H 33¹/₂ Seat Height 18 Inside Seat Width 33 Inside Seat Depth 19 Arm Height 25¹/₂ 2¹/₂ yds. 72 lbs. COL 50 sq. ft.</p>	2389	2552	2632	2682	2762	2849	2932	3014	3092	3184	3562	3849		



Specify Nylon Arm Color
 Black (-BN)
 Grey (-GN)

OPTIONS		
-PFW01	Premium Wood Finish, Arm Cap (per arm)	12
-CO01	Corian Arm Cap (per arm)	84
-SC02	Replaceable Seat Cover	84
-BC02	Replaceable Back Cover	64
-MB02	Moisture Barrier (seat only)	133
-PFM01	Alternate Metal Leg Finish (per arm frame)	78
-NS04	Non-Skid Glides	29

REPRISE METAL GUEST + TANDEM // DESIGNED BY DAVID DAHL

ORDERING REQUIREMENTS:

- » Model number
- » Nylon arm color
- » Arm cap selection and finish
- » Upholstery selection
- » Options, as applicable

MODEL NUMBER	PRODUCT SPECIFICATIONS	FABRIC GRADES										LEATHER			
		COM	A	1	2	COL		3	4	5	6	7	8	L1	L2
M3440-()-UB (BLACK) M3440-()-UG (GREY) 	Bariatric Chair, 34" Wide Urethane Arm Caps W 34 D 25 ¹ / ₂ H 33 ¹ / ₂ Seat Height 18 Inside Seat Width 30 Inside Seat Depth 19 Arm Height 25 ¹ / ₂ 2 ¹ / ₂ yds. 48 lbs. COL 50 sq. ft.	2064	2227	2307	2357	2437	2524	2607	2689	2767	2859	3237	3524		
M3445-()-UB (BLACK) M3445-()-UG (GREY) 	Bariatric Chair, 40" Wide Urethane Arm Caps W 40 D 25 ¹ / ₂ H 33 ¹ / ₂ Seat Height 18 Inside Seat Width 33 Inside Seat Depth 19 Arm Height 25 ¹ / ₂ 2 ¹ / ₂ yds. 72 lbs. COL 50 sq. ft.	2453	2616	2696	2746	2826	2913	2996	3078	3156	3248	3626	3913		

Specify Nylon Arm Color
 Black (-BN)
 Grey (-GN)

OPTIONS		
-SC02	Replaceable Seat Cover	84
-BC02	Replaceable Back Cover	64
-MB02	Moisture Barrier (seat only)	133
-PFM01	Alternate Metal Leg Finish (per arm frame)	78
-NS04	Non-Skid Glides	29



REPRISE METAL GUEST + TANDEM // DESIGNED BY DAVID DAHL

SPECIFICATIONS:

- » Includes arm frame for connecting purposes. To add seating units, subsequent chair will always be -AO (add-on) or -EU (end unit).
- » Tables are beech veneer or laminate with solid wood edge, 3/4" thick.
- » For Corian top, please specify '-CO' next to model number. Top will be 1 1/2" thick.

ORDERING REQUIREMENTS:

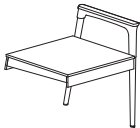
- » Model number
- » Nylon arm color
- » Arm cap selection and finish
- » Metal leg finish
- » Table top finish
- » Options, as applicable

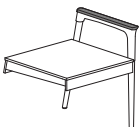
MODEL NUMBER	PRODUCT SPECIFICATIONS	TABLE TOP FINISH	
		VENEER OR LAMINATE	CORIAN (-CO)
M3417-15-()-W 	15" Inline Connecting Table Wood Arm Cap W 15 D 21 14 lbs. Field-Installed	1073	1685
M3417-21-()-W 	21" Inline Connecting Table Wood Arm Cap W 21 D 21 15 lbs. Field-Installed	1184	1949
M3417-15-()-UB (BLACK) M3417-15-()-UG (GREY) 	15" Inline Connecting Table Urethane Arm Cap W 15 D 21 14 lbs. Field-Installed	1105	1717
M3417-21-()-UB (BLACK) M3417-21-()-UG (GREY) 	21" Inline Connecting Table Urethane Arm Cap W 21 D 21 15 lbs. Field-Installed	1216	1981
Specify Nylon Arm Color Black (-BN) Grey (-GN)			



OPTIONS

-PFW01	Premium Wood Finish, Arm Cap (per arm)	12
-PFW04	Premium Wood Finish, Connecting Table	44
-CO	Corian Arm Cap (apply to wood arm cap List price)	84
-NS02	Non-Skid Glides	15
-PFM01	Alternate Metal Leg Finish (per arm frame)	78

REPRISE METAL GUEST + TANDEM // DESIGNED BY DAVID DAHL

PRODUCT FEATURES:

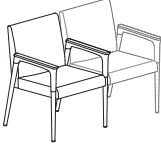
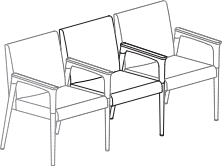
- » To build tandem configurations, always specify units from left-to-right as facing.
- » Starter units ('-ST') represent the first seating model in a configuration with subsequent modular units building onto them towards the right.
- » Add-On units ('-AO') can only be added next to Starter units or other Add-On units.
- » End-units ('-EU') represent the final seating model in a configuration.
- » Center tables are for inline placement only (cannot start or end a configuration) and includes arm frame for connecting purposes. To add seating units, subsequent chair will always be the 'AO' (add-on) or 'EU' (end unit).
- » Refer to page 3 for ordering requirements.

MODEL NUMBER	PRODUCT SPECIFICATIONS	FABRIC GRADES										LEATHER	
		COM	A	1	2	COL		3	4	5	6	7	8
M3420-ST-()-W 	Tandem Starter Unit Wood Arm Caps W 24 ¹ / ₂ D 25 ¹ / ₂ H 33 ¹ / ₂ Seat Height 18 Inside Seat Width 20 Inside Seat Depth 19 Arm Height 25 ¹ / ₂ 1 ¹ / ₂ yds. 37 lbs. COL 30 sq. ft.	1727	1825	1873	1903	1951	2003	2053	2102	2149	2204	2431	2603
M3420-AO-()-W 	Tandem Add-On Unit Wood Arm Cap W 22 ¹ / ₂ D 25 ¹ / ₂ H 33 ¹ / ₂ Seat Height 18 Inside Seat Width 20 Inside Seat Depth 19 Arm Height 25 ¹ / ₂ 1 ¹ / ₂ yds. 33 lbs. COL 30 sq. ft.	1505	1603	1651	1681	1729	1781	1831	1880	1927	1982	2209	2381
M3420-EU-()-W 	Tandem End Unit Wood Arm Cap W 22 ¹ / ₂ D 25 ¹ / ₂ H 33 ¹ / ₂ Seat Height 18 Inside Seat Width 20 Inside Seat Depth 19 Arm Height 25 ¹ / ₂ 1 ¹ / ₂ yds. 33 lbs. COL 30 sq. ft.	1505	1603	1651	1681	1729	1781	1831	1880	1927	1982	2209	2381
Specify Nylon Arm Color Black (-BN) Grey (-GN)	Connecting Tables Page 7 Bariatric Models Pages 10-13												



OPTIONS

-PFW01	Premium Wood Finish, Arm Cap (per arm)	12
-CO01	Corian Arm Cap (per arm)	84
-SC01	Replaceable Seat Cover (per seat)	64
-BC01	Replaceable Back Cover (per back)	42
-MB01	Moisture Barrier (seat only, per seat)	69
-PFM01	Alternate Metal Leg Finish (per arm frame)	78
-NS02	Non-Skid Glides (per arm frame)	15

REPRISE METAL GUEST + TANDEM // DESIGNED BY DAVID DAHL

PRODUCT FEATURES:

- » To build tandem configurations, always specify units from left-to-right as facing.
- » Starter units ('-ST') represent the first seating model in a configuration with subsequent modular units building onto them towards the right.
- » Add-On units ('-AO') can only be added next to Starter units or other Add-On units.
- » End-units ('-EU') represent the final seating model in a configuration.
- » Center tables are for inline placement only (cannot start or end a configuration) and include arm frame for connecting purposes. To add seating units, subsequent chair will always be the 'AO' (add-on) or 'EU' (end unit).
- » Refer to page 4 for ordering requirements.

MODEL NUMBER	PRODUCT SPECIFICATIONS	FABRIC GRADES										LEATHER		
		COM	A	1	2	COL		3	4	5	6	7	8	L1
M3420-ST(-)-UB (BLACK) M3420-ST(-)-UG (GREY)	Tandem Starter Unit Urethane Arm Caps W 24 ¹ / ₂ D 25 ¹ / ₂ H 33 ¹ / ₂ Seat Height 18 Inside Seat Width 20 Inside Seat Depth 19 Arm Height 25 ¹ / ₂ 1 ¹ / ₂ yds. 37 lbs. COL 30 sq. ft.	1791	1889	1937	1967	2015	2067	2117	2166	2213	2268	2495	2667	
														
M3420-AO(-)-UB (BLACK) M3420-AO(-)-UG (GREY)	Tandem Add-On Unit Urethane Arm Cap W 22 ¹ / ₂ D 25 ¹ / ₂ H 33 ¹ / ₂ Seat Height 18 Inside Seat Width 20 Inside Seat Depth 19 Arm Height 25 ¹ / ₂ 1 ¹ / ₂ yds. 33 lbs. COL 30 sq. ft.	1537	1635	1683	1713	1761	1813	1863	1912	1959	2014	2241	2413	
														
M3420-EU(-)-UB (BLACK) M3420-EU(-)-UG (GREY)	Tandem End Unit Urethane Arm Cap W 22 ¹ / ₂ D 25 ¹ / ₂ H 33 ¹ / ₂ Seat Height 18 Inside Seat Width 20 Inside Seat Depth 19 Arm Height 25 ¹ / ₂ 1 ¹ / ₂ yds. 33 lbs. COL 30 sq. ft.	1537	1635	1683	1713	1761	1813	1863	1912	1959	2014	2241	2413	
														
Specify Nylon Arm Color Black (-BN) Grey (-GN)	Connecting Tables Page 7 Bariatric Models Pages 10-13													

OPTIONS

-SC01	Replaceable Seat Cover (per seat)	64
-BC01	Replaceable Back Cover (per back)	42
-MB01	Moisture Barrier (seat only, per seat)	69
-PFM01	Alternate Metal Leg Finish (per arm frame)	78
-NS02	Non-Skid Glides (per arm frame)	15

REPRISE METAL GUEST + TANDEM // DESIGNED BY DAVID DAHL

PRODUCT FEATURES:

- » To build tandem configurations, always specify units from left-to-right as facing.
- » Starter units ('-ST') represent the first seating model in a configuration with subsequent modular units building onto them towards the right.
- » Add-On units ('-AO') can only be added next to Starter units or other Add-On units.
- » End-units ('-EU') represent the final seating model in a configuration.
- » Center tables are for inline placement only (cannot start or end a configuration) and include arm frame for connecting purposes. To add seating units, subsequent chair will always be the 'AO' (add-on) or 'EU' (end unit).
- » **Bariatric tandem chairs cannot be adjoined together side-by-side.**
- » Refer to page 3 for ordering requirements.

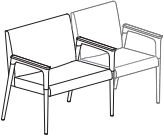
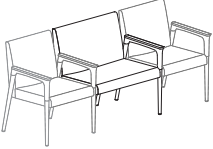
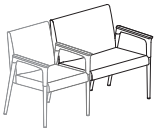
MODEL NUMBER	PRODUCT SPECIFICATIONS	FABRIC GRADES										LEATHER	
		COM	A	1	2	COL		3	4	5	6	7	8
M3440-ST(-)-W 	Tandem Bariatric Starter Unit 34" Wide, Wood Arm Caps W 34 D 25 ¹ / ₂ H 33 ¹ / ₂ Seat Height 18 Inside Seat Width 30 Inside Seat Depth 19 Arm Height 25 ¹ / ₂ 2 ¹ / ₂ yds. 48 lbs. COL 50 sq. ft.	2011	2174	2254	2304	2384	2471	2554	2636	2714	2806	3184	3471
M3440-AO(-)-W 	Tandem Bariatric Add-On Unit 34" Wide, Wood Arm Cap W 34 D 25 ¹ / ₂ H 33 ¹ / ₂ Seat Height 18 Inside Seat Width 30 Inside Seat Depth 19 Arm Height 25 ¹ / ₂ 2 ¹ / ₂ yds. 43 lbs. COL 50 sq. ft.	1788	1951	2031	2081	2161	2248	2331	2413	2491	2583	2961	3248
M3440-EU(-)-W 	Tandem Bariatric End Unit 34" Wide, Wood Arm Cap W 32 D 25 ¹ / ₂ H 33 ¹ / ₂ Seat Height 18 Inside Seat Width 30 Inside Seat Depth 19 Arm Height 25 ¹ / ₂ 2 ¹ / ₂ yds. 43 lbs. COL 50 sq. ft.	1788	1951	2031	2081	2161	2248	2331	2413	2491	2583	2961	3248
Specify Nylon Arm Color Black (-BN) Grey (-GN)	Connecting Tables Page 7 Tandem Seating Pages 8-9												

OPTIONS

-PFW01	Premium Wood Finish, Arm Cap (per arm)	12
-CO01	Corian Arm Cap (per arm)	84
-SC02	Replaceable Seat Cover (per seat)	84
-BC02	Replaceable Back Cover (per back)	64
-MB02	Moisture Barrier (seat only)	133
-PFM01	Alternate Metal Leg Finish (per arm frame)	78
-NS02	Non-Skid Glides (per arm frame)	15

REPRISE METAL GUEST + TANDEM // DESIGNED BY DAVID DAHL

PRODUCT FEATURES:

- » To build tandem configurations, always specify units from left-to-right as facing.
- » Starter units ('-ST') represent the first seating model in a configuration with subsequent modular units building onto them towards the right.
- » Add-On units ('-AO') can only be added next to Starter units or other Add-On units.
- » End-units ('-EU') represent the final seating model in a configuration.
- » Center tables are for inline placement only (cannot start or end a configuration) and include arm frame for connecting purposes. To add seating units, subsequent chair will always be the 'AO' (add-on) or 'EU' (end unit).
- » **Bariatric tandem chairs cannot be adjoined together side-by-side.**
- » Refer to page 4 for ordering requirements.

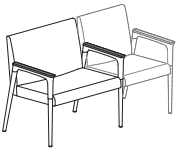
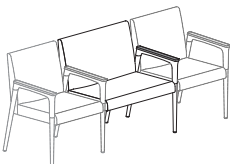
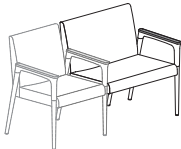
MODEL NUMBER	PRODUCT SPECIFICATIONS	FABRIC GRADES								LEATHER			
		COM	A	1	2	COL 3	4	5	6	7	8	L1	L2
M3440-ST(-)-UB (BLACK) M3440-ST(-)-UG (GREY) 	Tandem Bariatric Starter Unit 34" Wide, Urethane Arm Caps W 34 D 25 ¹ / ₂ H 33 ¹ / ₂ Seat Height 18 Inside Seat Width 30 Inside Seat Depth 19 Arm Height 25 ¹ / ₂ 2 ¹ / ₂ yds. 48 lbs. COL 50 sq. ft.	2075	2238	2318	2368	2448	2535	2618	2700	2778	2870	3248	3535
M3440-AO(-)-UB (BLACK) M3440-AO(-)-UG (GREY) 	Tandem Bariatric Add-On Unit 34" Wide, Urethane Arm Cap W 32 D 25 ¹ / ₂ H 33 ¹ / ₂ Seat Height 18 Inside Seat Width 30 Inside Seat Depth 19 Arm Height 25 ¹ / ₂ 2 ¹ / ₂ yds. 43 lbs. COL 50 sq. ft.	1820	1983	2063	2113	2193	2280	2363	2445	2523	2615	2993	3280
M3440-EU(-)-UB (BLACK) M3440-EU(-)-UG (GREY) 	Tandem Bariatric End Unit 34" Wide, Urethane Arm Cap W 32 D 25 ¹ / ₂ H 33 ¹ / ₂ Seat Height 18 Inside Seat Width 30 Inside Seat Depth 19 Arm Height 25 ¹ / ₂ 2 ¹ / ₂ yds. 43 lbs. COL 50 sq. ft.	1820	1983	2063	2113	2193	2280	2363	2445	2523	2615	2993	3280
Specify Nylon Arm Color Black (-BN) Grey (-GN)	Connecting Tables Page 7 Tandem Seating Pages 8-9												

OPTIONS		
-SC02	Replaceable Seat Cover (per seat)	84
-BC02	Replaceable Back Cover (per back)	64
-MB02	Moisture Barrier (seat only)	133
-PFM01	Alternate Metal Leg Finish (per arm frame)	78
-NS02	Non-Skid Glides (per arm frame)	15

REPRISE METAL GUEST + TANDEM // DESIGNED BY DAVID DAHL

PRODUCT FEATURES:

- » To build tandem configurations, always specify units from left-to-right as facing.
- » Starter units ('-ST') represent the first seating model in a configuration with subsequent modular units building onto them towards the right.
- » Add-On units ('-AO') can only be added next to Starter units or other Add-On units.
- » End-units ('-EU') represent the final seating model in a configuration.
- » Center tables are for inline placement only (cannot start or end a configuration) and include arm frame for connecting purposes. To add seating units, subsequent chair will always be the 'AO' (add-on) or 'EU' (end unit).
- » **Bariatric tandem chairs cannot be adjoined together side-by-side.**
- » Refer to page 3 for ordering requirements.

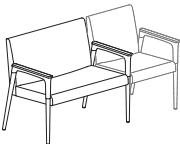
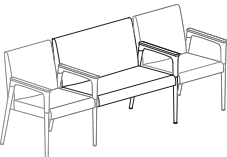
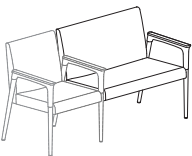
MODEL NUMBER	PRODUCT SPECIFICATIONS	FABRIC GRADES										LEATHER			
		COM	A	1	2	COL		3	4	5	6	7	8	L1	L2
M3445-ST(-)-W 	Tandem Bariatric Starter Unit 40" Wide, Wood Arm Caps W 40 D 25 ¹ / ₂ H 33 ¹ / ₂ Seat Height 18 Inside Seat Width 33 Inside Seat Depth 19 Arm Height 25 ¹ / ₂ 2 ¹ / ₂ yds. 72 lbs. COL 50 sq. ft.	2320	2483	2563	2613	2693	2780	2863	2945	3023	3115	3493	3780		
M3445-AO(-)-W 	Tandem Bariatric Add-On Unit 40" Wide, Wood Arm Cap W 38 D 25 ¹ / ₂ H 33 ¹ / ₂ Seat Height 18 Inside Seat Width 33 Inside Seat Depth 19 Arm Height 25 ¹ / ₂ 2 ¹ / ₂ yds. 66 lbs. COL 50 sq. ft.	2099	2262	2342	2392	2472	2559	2642	2724	2802	2894	3272	3559		
M3445-EU(-)-W 	Tandem Bariatric End Unit 40" Wide, Wood Arm Cap W 38 D 25 ¹ / ₂ H 33 ¹ / ₂ Seat Height 18 Inside Seat Width 33 Inside Seat Depth 19 Arm Height 25 ¹ / ₂ 2 ¹ / ₂ yds. 66 lbs. COL 50 sq. ft.	2099	2262	2342	2392	2472	2559	2642	2724	2802	2894	3272	3559		
Specify Nylon Arm Color Black (-BN) Grey (-GN)	Connecting Tables Page 7 Tandem Seating Pages 8-9														



OPTIONS

-PFW01	Premium Wood Finish, Arm Cap (per arm)	12
-CO01	Corian Arm Cap (per arm)	84
-SC02	Replaceable Seat Cover (per seat)	84
-BC02	Replaceable Back Cover (per back)	64
-MB02	Moisture Barrier (seat only)	133
-PFM01	Alternate Metal Leg Finish (per arm frame)	78
-NS02	Non-Skid Glides (per arm frame)	15

REPRISE METAL GUEST + TANDEM // DESIGNED BY DAVID DAHL

PRODUCT FEATURES:

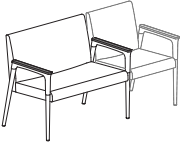
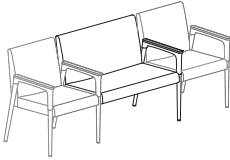
- » To build tandem configurations, always specify units from left-to-right as facing.
- » Starter units ('-ST') represent the first seating model in a configuration with subsequent modular units building onto them towards the right.
- » Add-On units ('-AO') can only be added next to Starter units or other Add-On units.
- » End-units ('-EU') represent the final seating model in a configuration.
- » Center tables are for inline placement only (cannot start or end a configuration) and include arm frame for connecting purposes. To add seating units, subsequent chair will always be the 'AO' (add-on) or 'EU' (end unit).
- » **Bariatric tandem chairs cannot be adjoined together side-by-side.**
- » Refer to page 4 for ordering requirements.

MODEL NUMBER	PRODUCT SPECIFICATIONS	FABRIC GRADES								LEATHER			
		COM	A	1	2	COL 3	4	5	6	7	8	L1	L2
M3445-ST-()-UB (BLACK) M3445-ST-()-UG (GREY)	Tandem Bariatric Starter Unit 40" Wide, Urethane Arm Caps W 40 D 25 ¹ / ₂ H 33 ¹ / ₂ Seat Height 18 Inside Seat Width 33 Inside Seat Depth 19 Arm Height 25 ¹ / ₂ 2 ¹ / ₂ yds. 72 lbs. COL 50 sq. ft.	2384	2547	2627	2677	2757	2844	2927	3009	3087	3179	3557	3844
													
M3445-AO-()-UB (BLACK) M3445-AO-()-UG (GREY)	Tandem Bariatric Add-On Unit 40" Wide, Urethane Arm Cap W 38 D 25 ¹ / ₂ H 33 ¹ / ₂ Seat Height 18 Inside Seat Width 33 Inside Seat Depth 19 Arm Height 25 ¹ / ₂ 2 ¹ / ₂ yds. 66 lbs. COL 50 sq. ft.	2131	2294	2374	2424	2504	2591	2674	2756	2834	2926	3304	3591
													
M3445-EU-()-UB (BLACK) M3445-EU-()-UG (GREY)	Tandem Bariatric End Unit 40" Wide, Urethane Arm Cap W 38 D 25 ¹ / ₂ H 33 ¹ / ₂ Seat Height 18 Inside Seat Width 33 Inside Seat Depth 19 Arm Height 25 ¹ / ₂ 2 ¹ / ₂ yds. 66 lbs. COL 50 sq. ft.	2131	2294	2374	2424	2504	2591	2674	2756	2834	2926	3304	3591
													
Specify Nylon Arm Color Black (-BN) Grey (-GN)	Connecting Tables Page 7 Tandem Seating Pages 8-9												

OPTIONS

-SC02	Replaceable Seat Cover (per seat)	84
-BC02	Replaceable Back Cover (per back)	64
-MB02	Moisture Barrier (seat only)	133
-PFM01	Alternate Metal Leg Finish (per arm frame)	78
-NS02	Non-Skid Glides (per arm frame)	15

REPRISE METAL GUEST + TANDEM // DESIGNED BY DAVID DAHL

CONFIGURATION EXAMPLES:

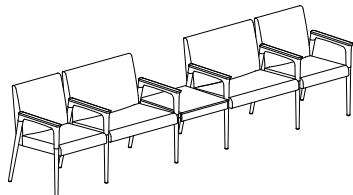

Qty	Model #	Description	COM List
1	M3420-ST-W	Tandem Starter Unit, Wood Arm Caps	\$1,727
1	M3440-EU-W	34" Wide Bariatric End Unit, Wood Arm Cap	\$1,788
1	M3417-21-W	21" Center Inline Table	\$1,184
1	M3440-ST-W	34" Wide Bariatric Starter Unit, Wood Arm Caps	\$2,011
1	M3420-EU-W	Tandem End Unit, Wood Arm Cap	\$1,505
			\$8,215

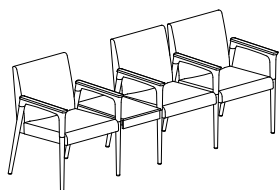

Qty	Model #	Description	COM List
1	M3420-ST-UG	Tandem Starter Unit, Urethane Arm Caps	\$1,791
1	M3417-15-UG	15" Center Inline Table	\$1,105
1	M3420-AO-UG	Tandem Add-On Unit, Urethane Arm Cap	\$1,537
1	M3420-EU-UG	Tandem End Unit, Urethane Arm Cap	\$1,537
			\$5,970

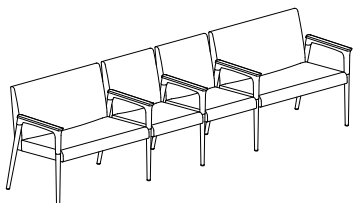

Qty	Model #	Description	COM List
1	M3445-ST-W	40" Wide Bariatric Starter Unit, Wood Arm Caps	\$2,320
2	M3420-AO-W	Tandem Add-On Unit, Wood Arm Cap (\$1,505 each)	\$3,010
1	M3445-EU-W	40" Wide Bariatric End Unit, Wood Arm Cap	\$2,099
			\$7,429

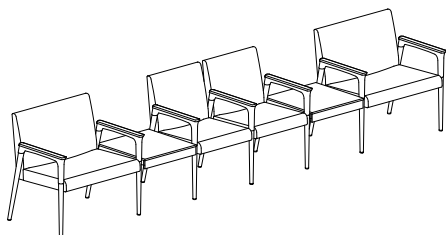



Qty	Model #	Description	COM List
1	M3440-ST-W	34" Wide Bariatric Starter Unit, Wood Arm Caps	\$2,011
2	M3417-21-W	21" Center Inline Table (\$1184 each)	\$2,368
2	M3420-AO-W	Tandem Add-On Unit, Wood Arm Cap (\$1,505 each)	\$3,010
1	M3440-EU-W	34" Wide Bariatric End Unit, Wood Arm Cap	\$1,788
			\$9,177

REPRISE METAL GUEST + TANDEM // DESIGNED BY DAVID DAHL

ORDERING REQUIREMENTS:

- » Model number
- » Nylon arm color
- » Arm cap selection and finish
- » Upholstery selection
- » Options, as applicable

Note: For Corian arm caps, specify '-CO' in place of '-W' after model number and refer to options below for upcharge.

MODEL NUMBER	PRODUCT SPECIFICATIONS	FABRIC GRADES										LEATHER	
		COM	A	1	2	COL		3	4	5	6	7	8
M3450(-)-W 	Patient Chair Wood Arm Caps W 24 ¹ / ₂ D 25 ¹ / ₂ H 44 Seat Height 18 Inside Seat Width 20 Inside Seat Depth 19 Arm Height 25 ¹ / ₂ 2 ¹ / ₄ yds. 40 lbs. COL 45 sq. ft.	1867	2014	2086	2131	2203	2281	2356	2430	2500	2583	2923	3181
M3450(-)-UB (BLACK) M3450(-)-UG (GREY) 	Patient Chair Urethane Arm Caps W 24 ¹ / ₂ D 25 ¹ / ₂ H 44 Seat Height 18 Inside Seat Width 20 Inside Seat Depth 19 Arm Height 25 ¹ / ₂ 2 ¹ / ₄ yds. 40 lbs. COL 45 sq. ft.	1931	2078	2150	2195	2267	2345	2420	2494	2564	2647	2987	3245

Specify Nylon Arm Color
 Black (-BN)
 Grey (-GN)



OPTIONS		
-CO01	Corian Arm Cap (per arm)	84
-SC01	Replaceable Seat Cover	64
-BC01	Replaceable Back Cover	42
-MB01	Moisture Barrier (seat only)	69
-PFM01	Alternate Metal Leg Finish (per arm frame)	78
-NS04	Non-Skid Glides	29

REPRISE METAL GUEST + TANDEM // DESIGNED BY DAVID DAHL

ORDERING REQUIREMENTS:

- » Model number
- » Nylon arm color
- » Arm cap selection and finish
- » Upholstery selection
- » Options, as applicable

Note: For Corian arm caps, specify '-CO' in place of '-W' after model number and refer to options below for upcharge.

MODEL NUMBER	PRODUCT SPECIFICATIONS	FABRIC GRADES										LEATHER			
		COM	A	1	2	COL		3	4	5	6	7	8	L1	L2
M3457(-)-W 	Easy Access/Hip Chair Wood Arm Caps W 24 ¹ / ₂ D 25 ¹ / ₂ H 39 ¹ / ₂ Seat Height 25 Inside Seat Width 20 Inside Seat Depth 19 Arm Height 32 ¹ / ₂ 1 ¹ / ₂ yds. 44 lbs. COL 30 sq. ft.	2115	2213	2261	2291	2339	2391	2441	2490	2537	2592	2819	2991		
M3457(-)-UB (BLACK) M3457(-)-UG (GREY) 	Easy Access/Hip Chair Urethane Arm Caps W 24 ¹ / ₂ D 25 ¹ / ₂ H 39 ¹ / ₂ Seat Height 25 Inside Seat Width 20 Inside Seat Depth 19 Arm Height 32 ¹ / ₂ 1 ¹ / ₂ yds. 44 lbs. COL 30 sq. ft.	2179	2277	2325	2355	2403	2455	2505	2554	2601	2656	2883	3055		

Brushed Stainless Steel
foot step is positioned 6.5"
from the floor.



Specify Nylon Arm Color
Black (-BN)
Grey (-GN)

OPTIONS		
-CO01	Corian Arm Cap (per arm)	84
-SC01	Replaceable Seat Cover	64
-BC01	Replaceable Back Cover	42
-MB01	Moisture Barrier (seat only)	69
-PFM01	Alternate Metal Leg Finish (per arm frame)	78
-NS04	Non-Skid Glides	29

REPRISE METAL GUEST + TANDEM // DESIGNED BY DAVID DAHL

PRODUCT FEATURES:

- » Concealed velcro attachment.
- » Replacement seat and back covers can be easily field installed on previously ordered Reprise Metal models with replaceable cover option.
- » Reprise models originally ordered with standard fixed upholstery can utilize replacement seat and/or back covers, however some upholstery work will be required to remove original upholstery covers.

MODEL NUMBER	PRODUCT SPECIFICATIONS	FABRIC GRADES										LEATHER	
		COM	A	1	2	COL 3	4	5	6	7	8	L1	L2
MRSC-3410 	Replacement Upholstered Seat Cover 1 yd. COL 20 sq. ft. Applies to: M3410 Guest M3420 Tandem M3450 Patient Chair M3457 Easy Access/Hip Chair	178	243	275	295	327	362	395	428	459	496	647	762
MRBC-3410 	Replacement Upholstered Back Cover 1 yd. COL 20 sq. ft. Applies to: M3410 Guest M3420 Tandem M3457 Easy Access/Hip Chair	198	263	295	315	347	382	415	448	479	516	667	782
OPTIONS													
-MB01	Moisture Barrier (seat only)	69											

REPRISE METAL GUEST + TANDEM // DESIGNED BY DAVID DAHL

PRODUCT FEATURES:

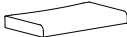
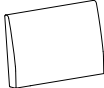
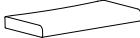
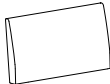

- » Concealed velcro attachment.
- » Replacement seat and back covers can be easily field installed on previously ordered Reprise Metal models with replaceable cover option.
- » Reprise models originally ordered with standard fixed upholstery can utilize replacement seat and/or back covers, however some upholstery work will be required to remove original upholstery covers.

MODEL NUMBER	PRODUCT SPECIFICATIONS	FABRIC GRADES										LEATHER	
		COM	A	1	2	COL		3	4	5	6	7	8
MRSC-3440 	34" Wide Bariatric Settee Replacement Upholstered Seat Cover 1 yd. COL 20 sq. ft.	247	312	344	364	396	431	464	497	528	565	716	831
MRBC-3440 	34" Wide Bariatric Settee Replacement Upholstered Back Cover 1 1/2 yds. COL 30 sq. ft.	247	345	393	423	471	523	573	622	669	724	951	1123
MRSC-3445 	40" Wide Bariatric Settee Replacement Upholstered Seat Cover 1 1/4 yds. COL 25 sq. ft.	247	329	369	394	434	477	519	560	599	645	834	977
MRBC-3445 	40" Wide Bariatric Settee Replacement Upholstered Back Cover 1 1/2 yds. COL 30 sq. ft.	247	345	393	423	471	523	573	622	669	724	951	1123
OPTIONS													
-MB02	Moisture Barrier (seat only)	133											

REPRISE METAL GUEST + TANDEM // DESIGNED BY DAVID DAHL

PRODUCT FEATURES:

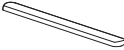
- » Replacement hardware included with replacement frames.

MODEL NUMBER	PRODUCT SPECIFICATIONS	LIST
<p>M3410-()-05R (RIGHT ARM, AS SEATED) M3410-()-05C (CENTER ARM, AS SEATED) M3410-()-05L (LEFT ARM, AS SEATED)</p> 	<p>Replacement Guest Chair Frame No Arm Cap 8 lbs.</p>	<p>315</p>
<p>Specify Nylon Arm Color Black (-BN) Grey (-GN)</p>		
<p>3410-07W (WOOD)</p> 	<p>Replacement Wood Arm Cap 2 lbs.</p>	<p>177</p>
<p>3410-07UB (BLACK) 3410-07UG (GREY)</p> 	<p>Replacement Urethane Arm Cap, Black or Grey 2 lbs.</p>	<p>152</p>
<p>3410-07C (CORIAN)</p> 	<p>Replacement Corian Arm Cap (standard colors only) 2 lbs.</p>	<p>281</p>

OPTIONS		
-PFM01	Alternate Metal Leg Finish (per arm frame)	78
-PFW01	Premium Wood Finish, Arm Cap (per arm)	12
-NS02	Non-Skid Glides	15

REPRISE METAL GUEST + TANDEM // DESIGNED BY DAVID DAHL

UPHOLSTERY COMBINATIONS:

- » When combining two COM/COV/COL fabrics, or fabrics with the same grade, add \$120 List per unit.
- » When combining three COM/COV/COL fabrics, or fabrics with the same grade, add \$150 List per unit.
- » When combining different grades of fabric, price will be based on the highest grade specified.
- » Two-tone upholstery examples and yardage requirements for the most common combinations are listed below. Additional combinations available, please contact client services for yardage requirements and pricing.
- » Note: Yardage amounts are based on fabric which is plain (i.e. non-directional) and a full 54" wide.
- » Appropriate upholstery code must be included.



Code **RE1**
Models COM Requirement
 All Guest Seat = 1 yd.
 & Easy Back = 1 yd.
 Access Units



Code **RE2**
Models COM Requirement
 All 34" W Seat = 1 yd.
 Bariatric Back = 1 1/2 yds.
 Units

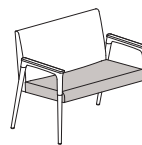

Code **RE3**
Models COM Requirement
 All 40" W Seat = 1 1/4 yds.
 Bariatric Back = 1 1/2 yds.
 Units



Code **RE4**
Models COM Requirement
 M3450-W Seat = 1 1/4 yds.
 M3450-U Back = 2 1/4 yds.

REPRISE WOOD SEATING



MARCH 1, 2026
VA IDIQ CONTRACT (FY26)
(DEALER HELD)

REPRISE WOOD GUEST + TANDEM // DESIGNED BY DAVID DAHL



PRODUCT FEATURES:

- » All models feature clean-outs on all sides, including between seat and back, for maintenance ease.
- » Radiused arm caps for smooth surface contact.
- » Wall-saver leg design.
- » Field-replaceable components available, refer to pages 17-19.
- » Optional replaceable seat upholstery available on all units.
- » Replacement seat and back covers (excluding patient chair) can be easily field-installed on previously ordered Reprise Wood models with standard fixed upholstery. Contact client services for instructions.
- » All dimensions are nominal.

TANDEM + MODULAR FEATURES:

- » To build tandem configurations, always specify units from left-to-right, as facing.
- » Available in two and three-seat combinations or as reconfigurable modular units.
- » Inline connecting tables available in 15" and 21" widths, with beech veneer, laminate or Corian tops. Custom sizes available, contact client services for pricing.
- » **Note: Please include layout drawings or sketch with each order.**
- » Arcadia will pre-assemble units at the factory to maximize shipping allowances and minimize field assembly.

SPECIFICATIONS:

- » Four arm cap options: beech wood, black urethane, grey urethane and Corian.
- » For Corian arm caps, please specify '-CO' in place of the '-W' after model number with color selection and refer to options for upcharge.
- » Wood arm caps, as well as veneer connecting tables, available in all standard and custom wood finishes on beech.
- » For Super Matte Sable Beech, premium wood finish upcharge applies. Refer to options section for pricing.
- » For custom wood finishes to arm caps and/or inline table, please add one-time upcharge of \$514 List per color per order.
- » For custom laminates (applies to connecting tables only), add \$642 List per color per order. Pre-approval required, please contact client services.
- » Corian arm caps and inline tables available in six standard colors. For non-standard colors, please contact client services for pricing.

REPRISE WOOD GUEST + TANDEM // DESIGNED BY DAVID DAHL

CORIAN® COLORS:

- » CWN Designer White
- » CLN Linen
- » CTD Witch Hazel
- » CRC Rain Cloud
- » CGQ Grey Onyx
- » CSQ Stonique

WEIGHT CAPACITY:

- | | |
|-------------------------|-------------------|
| » Guest Chair | 350 lbs. |
| » Preconfigured Tandem | 350 lbs. per seat |
| » Reconfigurable Tandem | 350 lbs. per seat |
| » Bariatric Chairs | 750 lbs. |
| » Patient Chair | 350 lbs. |
| » Easy Access/Hip Chair | 350 lbs. |

ORDERING REQUIREMENTS:

- » Model number
- » Arm cap selection and finish
- » Frame finish
- » Upholstery selection
- » Options, as applicable

REPRISE WOOD GUEST + TANDEM // DESIGNED BY DAVID DAHL

ORDERING REQUIREMENTS:

- » Model number » Upholstery selection
- » Arm cap finish » Options, as applicable
- » Wood frame finish

Note: For Corian arm caps, specify '-CO' in place of '-W' after model number and refer to options below for upcharge.

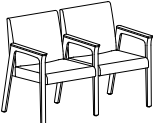
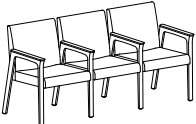
MODEL NUMBER	PRODUCT SPECIFICATIONS	FABRIC GRADES										LEATHER			
		COM	A	1	2	COL		3	4	5	6	7	8	L1	L2
3410-W 	Single Guest Chair Wood Arm Caps W 24 ¹ / ₂ D 25 ¹ / ₂ H 33 ¹ / ₂ Seat Height 18 Inside Seat Width 20 Inside Seat Depth 19 Arm Height 25 ¹ / ₂ 1 ¹ / ₂ yds. 34 lbs. COL 30 sq. ft.	1718	1816	1864	1894	1942	1994	2044	2093	2140	2195	2422	2594		
3410-2-W 	Two-Seat Tandem Wood Arm Caps W 47 D 25 ¹ / ₂ H 33 ¹ / ₂ Seat Height 18 Inside Seat Width 20 Inside Seat Depth 19 Arm Height 25 ¹ / ₂ 3 yds. 62 lbs. COL 60 sq. ft.	3170	3365	3461	3521	3617	3722	3821	3920	4013	4124	4577	4922		
3410-3-W 	Three-Seat Tandem Wood Arm Caps W 70 D 25 ¹ / ₂ H 33 ¹ / ₂ Seat Height 18 Inside Seat Width 20 Inside Seat Depth 19 Arm Height 25 ¹ / ₂ 4 ¹ / ₂ yds. 91 lbs. COL 90 sq. ft.	4619	4912	5056	5146	5290	5447	5596	5744	5884	6050	6730	7247		



OPTIONS

-PFW01	Premium Wood Finish, Arm Cap (per arm)	12
-PFW03	Premium Wood Finish, Frame	34
-CO01	Corian Arm Cap (per arm)	84
-SC01	Replaceable Seat Cover (per seat)	64
-BC01	Replaceable Back Cover (per back)	42
-MB01	Moisture Barrier (seat only, per seat)	69
-NS02	Non-Skid Glides (per arm frame)	15

REPRISE WOOD GUEST + TANDEM // DESIGNED BY DAVID DAHL

ORDERING REQUIREMENTS:

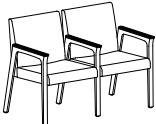
- » Model number
- » Wood frame finish
- » Upholstery selection
- » Options, as applicable

MODEL NUMBER	PRODUCT SPECIFICATIONS	FABRIC GRADES										LEATHER	
		COM	A	1	2	COL		3	4	5	6	7	8
3410-UB (BLACK) 3410-UG (GREY) 	Single Guest Chair Urethane Arm Caps W 24 ¹ / ₂ D 25 ¹ / ₂ H 33 ¹ / ₂ Seat Height 18 Inside Seat Width 20 Inside Seat Depth 19 Arm Height 25 ¹ / ₂ 1 ¹ / ₂ yds. 34 lbs. COL 30 sq. ft.	1782	1880	1928	1958	2006	2058	2108	2157	2204	2259	2486	2658
3410-2-UB (BLACK) 3410-2-UG (GREY) 	Two-Seat Tandem Urethane Arm Caps W 47 D 25 ¹ / ₂ H 33 ¹ / ₂ Seat Height 18 Inside Seat Width 20 Inside Seat Depth 19 Arm Height 25 ¹ / ₂ 3 yds. 62 lbs. COL 60 sq. ft.	3266	3461	3557	3617	3713	3818	3917	4016	4109	4220	4673	5018
3410-3-UB (BLACK) 3410-3-UG (GREY) 	Three-Seat Tandem Urethane Arm Caps W 70 D 25 ¹ / ₂ H 33 ¹ / ₂ Seat Height 18 Inside Seat Width 20 Inside Seat Depth 19 Arm Height 25 ¹ / ₂ 4 ¹ / ₂ yds. 91 lbs. COL 90 sq. ft.	4747	5040	5184	5274	5418	5575	5724	5872	6012	6178	6858	7375

OPTIONS

-PFW03	Premium Wood Finish, Frame	34
-SC01	Replaceable Seat Cover (per seat)	64
-BC01	Replaceable Back Cover (per back)	42
-MB01	Moisture Barrier (seat only, per seat)	69
-NS02	Non-Skid Glides (per arm frame)	15

REPRISE WOOD GUEST + TANDEM // DESIGNED BY DAVID DAHL

ORDERING REQUIREMENTS:

- » Model number
- » Upholstery selection
- » Arm cap finish
- » Options, as applicable
- » Wood frame finish

Note: For Corian arm caps, specify '-CO' in place of '-W' after model number and refer to options below for upcharge.

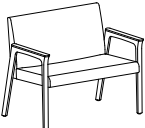
MODEL NUMBER	PRODUCT SPECIFICATIONS	FABRIC GRADES										LEATHER			
		COM	A	1	2	COL		3	4	5	6	7	8	L1	L2
3440-W	 <p>Bariatric Settee, 34" Wide Wood Arm Caps W 34 D 25¹/₂ H 33¹/₂ Seat Height 18 Inside Seat Width 30 Inside Seat Depth 19 Arm Height 25¹/₂ 2¹/₂ yds. 45 lbs. COL 50 sq. ft.</p>	2064	2227	2307	2357	2437	2524	2607	2689	2767	2859	3237	3524		
3445-W	 <p>Bariatric Settee, 40" Wide Wood Arm Caps W 40 D 25¹/₂ H 33¹/₂ Seat Height 18 Inside Seat Width 33 Inside Seat Depth 19 Arm Height 25¹/₂ 2¹/₂ yds. 68 lbs. COL 50 sq. ft.</p>	2428	2591	2671	2721	2801	2888	2971	3053	3131	3223	3601	3888		



OPTIONS

-PFW01	Premium Wood Finish, Arm Cap (per arm)	12
-PFW03	Premium Wood Finish, Frame	34
-CO01	Corian Arm Cap (per arm)	84
-SC02	Replaceable Seat Cover	84
-BC02	Replaceable Back Cover	64
-MB02	Moisture Barrier	133
-NS04	Non-Skid Glides	29

REPRISE WOOD GUEST + TANDEM // DESIGNED BY DAVID DAHL

ORDERING REQUIREMENTS:

- » Model number
- » Wood frame finish
- » Upholstery selection
- » Options, as applicable

MODEL NUMBER	PRODUCT SPECIFICATIONS	FABRIC GRADES										LEATHER	
		COM	A	1	2	COL		3	4	5	6	7	8
3440-UB (BLACK) 3440-UG (GREY) 	Bariatric Settee, 34" Wide Urethane Arm Caps W 34 D 25 ¹ / ₂ H 33 ¹ / ₂ Seat Height 18 Inside Seat Width 30 Inside Seat Depth 19 Arm Height 25 ¹ / ₂ 2 ¹ / ₂ yds. 45 lbs. COL 50 sq. ft.	2128	2291	2371	2421	2501	2588	2671	2753	2831	2923	3301	3588
3445-UB (BLACK) 3445-UG (GREY) 	Bariatric Settee, 40" Wide Urethane Arm Caps W 40 D 25 ¹ / ₂ H 33 ¹ / ₂ Seat Height 18 Inside Seat Width 33 Inside Seat Depth 19 Arm Height 25 ¹ / ₂ 2 ¹ / ₂ yds. 68 lbs. COL 50 sq. ft.	2492	2655	2735	2785	2865	2952	3035	3117	3195	3287	3665	3952

OPTIONS

-PFW03	Premium Wood Finish, Frame	34
-SC02	Replaceable Seat Cover	84
-BC02	Replaceable Back Cover	64
-MB02	Moisture Barrier	133
-NS04	Non-Skid Glides	29



REPRISE WOOD GUEST + TANDEM // DESIGNED BY DAVID DAHL

SPECIFICATIONS:

- » Includes arm frame for connecting purposes. To add seating units, subsequent chair will always be -AO (add-on) or -EU (end unit).
- » Tables are beech veneer or laminate with hardwood edge, 3/4" thick.
- » For Corian top, please specify '-CO' next to model number. Top will be 1 1/2" thick.

ORDERING REQUIREMENTS:

- » Model number
- » Wood frame finish
- » Arm cap selection and finish
- » Table top finish
- » Options, as applicable

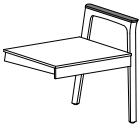
MODEL NUMBER	PRODUCT SPECIFICATIONS	TABLE TOP FINISH	
		VENEER OR LAMINATE	CORIAN (-CO)
3417-15-W 	15" Inline Connecting Table Wood Arm Cap W 15 D 21 13 lbs. Field Installed	956	1549
3417-21-W 	21" Inline Connecting Table Wood Arm Cap W 21 D 21 14 lbs. Field Installed	1084	1881
3417-15-UB (BLACK) 3417-15-UG (GREY) 	15" Inline Connecting Table Urethane Arm Cap W 15 D 21 14 lbs. Field-Installed	988	1581
3417-21-UB (BLACK) 3417-21-UG (GREY) 	21" Inline Connecting Table Urethane Arm Cap W 21 D 21 15 lbs. Field-Installed	1116	1913

OPTIONS		
-PFW01	Premium Wood Finish, Arm Cap (per arm)	12
-PFW03	Premium Wood Finish, Frame	34
-PFW04	Premium Wood Finish, Connecting Table	44
-CO01	Corian Arm Cap (apply to wood arm cap List price)	84
-NS02	Non-Skid Glides	15

REPRISE WOOD GUEST + TANDEM // DESIGNED BY DAVID DAHL

ORDERING GUIDELINES:

- » To build tandem configurations, always specify units from left-to-right as facing.
- » Starter units ('-ST') represent the first seating model in a configuration with subsequent modular units building onto them towards the right.
- » Add-On units ('-AO') can only be added next to Starter units or other Add-On units.
- » End-units ('-EU') represent the final seating model in a configuration.
- » Center tables are for inline placement only (cannot start or end a configuration) and includes arm frame for connecting purposes. To add seating units, subsequent chair will always be the 'AO' (add-on) or 'EU' (end unit).
- » For Corian arm caps, specify '-CO' in place of '-W' after model number and refer to options below for upcharge.
- » Refer page 3 for ordering requirements.

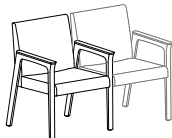
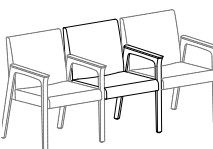
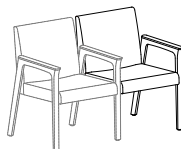
MODEL NUMBER	PRODUCT SPECIFICATIONS	FABRIC GRADES										LEATHER			
		COM	A	1	2	COL		3	4	5	6	7	8	L1	L2
3420-ST-W 	Tandem Starter Unit Wood Arm Caps W 24 ¹ / ₂ D 25 ¹ / ₂ H 33 ¹ / ₂ Seat Height 18 Inside Seat Width 20 Inside Seat Depth 19 Arm Height 25 ¹ / ₂ 1 ¹ / ₂ yds. 34 lbs. COL 30 sq. ft.	1720	1818	1866	1896	1944	1996	2046	2095	2142	2197	2424	2596		
3420-AO-W 	Tandem Add-On Unit Wood Arm Cap W 22 ¹ / ₂ D 25 ¹ / ₂ H 33 ¹ / ₂ Seat Height 18 Inside Seat Width 20 Inside Seat Depth 19 Arm Height 25 ¹ / ₂ 1 ¹ / ₂ yds. 31 lbs. COL 30 sq. ft.	1510	1608	1656	1686	1734	1786	1836	1885	1932	1987	2214	2386		
3420-EU-W 	Tandem End Unit Wood Arm Cap W 22 ¹ / ₂ D 25 ¹ / ₂ H 33 ¹ / ₂ Seat Height 18 Inside Seat Width 20 Inside Seat Depth 19 Arm Height 25 ¹ / ₂ 1 ¹ / ₂ yds. 31 lbs. COL 30 sq. ft.	1510	1608	1656	1686	1734	1786	1836	1885	1932	1987	2214	2386		
	Connecting Tables Page 7 Bariatric Models Pages 10-13														

OPTIONS		
-PFW01	Premium Wood Finish, Arm Cap (per arm)	12
-PFW03	Premium Wood Finish, Frame	34
-CO01	Corian Arm Cap (per arm)	84
-SC01	Replaceable Seat Cover (per seat)	64
-BC01	Replaceable Back Cover (per back)	42
-MB01	Moisture Barrier (seat only, per seat)	69
-NS02	Non-Skid Glides (per arm frame)	15

REPRISE WOOD GUEST + TANDEM // DESIGNED BY DAVID DAHL

ORDERING GUIDELINES:

- » To build tandem configurations, always specify units from left-to-right as facing.
- » Starter units ('-ST') represent the first seating model in a configuration with subsequent modular units building onto them towards the right.
- » Add-On units ('-AO') can only be added next to Starter units or other Add-On units.
- » End-units ('-EU') represent the final seating model in a configuration.
- » Center tables are for inline placement only (cannot start or end a configuration) and includes arm frame for connecting purposes. To add seating units, subsequent chair will always be the 'AO' (add-on) or 'EU' (end unit).
- » For Corian arm caps, specify '-CO' in place of '-W' after model number and refer to options below for upcharge.
- » Refer page 4 for ordering requirements.

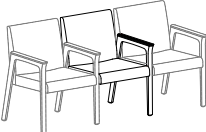
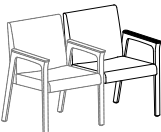

MODEL NUMBER	PRODUCT SPECIFICATIONS	FABRIC GRADES										LEATHER	
		COM	A	1	2	COL		3	4	5	6	7	8
3420-ST-UB (BLACK) 3420-ST-UG (GREY) 	Tandem Starter Unit Urethane Arm Caps W 24 ¹ / ₂ D 25 ¹ / ₂ H 33 ¹ / ₂ Seat Height 18 Inside Seat Width 20 Inside Seat Depth 19 Arm Height 25 ¹ / ₂ 1 ¹ / ₂ yds. 34 lbs. COL 30 sq. ft.	1784	1882	1930	1960	2008	2060	2110	2159	2206	2261	2488	2660
3420-AO-UB (BLACK) 3420-AO-UG (GREY) 	Tandem Add-On Unit Urethane Arm Cap W 22 ¹ / ₂ D 25 ¹ / ₂ H 33 ¹ / ₂ Seat Height 18 Inside Seat Width 20 Inside Seat Depth 19 Arm Height 25 ¹ / ₂ 1 ¹ / ₂ yds. 31 lbs. COL 30 sq. ft.	1542	1640	1688	1718	1766	1818	1868	1917	1964	2019	2246	2418
3420-EU-UB (BLACK) 3420-EU-UG (GREY) 	Tandem End Unit Urethane Arm Cap W 22 ¹ / ₂ D 25 ¹ / ₂ H 33 ¹ / ₂ Seat Height 18 Inside Seat Width 20 Inside Seat Depth 19 Arm Height 25 ¹ / ₂ 1 ¹ / ₂ yds. 31 lbs. COL 30 sq. ft.	1542	1640	1688	1718	1766	1818	1868	1917	1964	2019	2246	2418
	Connecting Tables Page 7 Bariatric Models Pages 10-13												

OPTIONS		
-PFW03	Premium Wood Finish, Frame	34
-SC01	Replaceable Seat Cover (per seat)	64
-BC01	Replaceable Back Cover (per back)	42
-MB01	Moisture Barrier (seat only, per seat)	69
-NS02	Non-Skid Glides (per arm frame)	15

REPRISE WOOD GUEST + TANDEM // DESIGNED BY DAVID DAHL

ORDERING GUIDELINES:

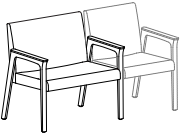
- » To build tandem configurations, always specify units from left-to-right as facing.
- » Starter units ('-ST') represent the first seating model in a configuration with subsequent modular units building onto them towards the right.
- » Add-On units ('-AO') can only be added next to Starter units or other Add-On units.
- » End-units ('-EU') represent the final seating model in a configuration.
- » Center tables are for inline placement only (cannot start or end a configuration) and includes arm frame for connecting purposes. To add seating units, subsequent chair will always be the 'AO' (add-on) or 'EU' (end unit).
- » **Bariatric tandem chairs cannot be adjoined together side-by-side.**
- » For Corian arm caps, please specify "-CO" in place of the "-W" after model number (with color selection) and refer to options below for upcharge.»
- » Refer page 3 for ordering requirements.

MODEL NUMBER	PRODUCT SPECIFICATIONS	FABRIC GRADES										LEATHER	
		COM	A	1	2	COL		3	4	5	6	7	8
3440-ST-W 	Tandem Bariatric Starter Unit 34" Wide, Wood Arm Caps W 34 D 25 ¹ / ₂ H 33 ¹ / ₂ Seat Height 18 Inside Seat Width 30 Inside Seat Depth 19 Arm Height 25 ¹ / ₂ 2 ¹ / ₂ yds. 45 lbs. COL 50 sq. ft.	2135	2298	2378	2428	2508	2595	2678	2760	2838	2930	3308	3595
3440-AO-W 	Tandem Bariatric Add-On Unit 34" Wide, Wood Arm Cap W 32 D 25 ¹ / ₂ H 33 ¹ / ₂ Seat Height 18 Inside Seat Width 30 Inside Seat Depth 19 Arm Height 25 ¹ / ₂ 2 ¹ / ₂ yds. 41 lbs. COL 50 sq. ft.	1821	1984	2064	2114	2194	2281	2364	2446	2524	2616	2994	3281
3440-EU-W 	Tandem Bariatric End Unit 34" Wide, Wood Arm Cap W 32 D 25 ¹ / ₂ H 33 ¹ / ₂ Seat Height 18 Inside Seat Width 30 Inside Seat Depth 19 Arm Height 25 ¹ / ₂ 2 ¹ / ₂ yds. 41 lbs. COL 50 sq. ft.	1821	1984	2064	2114	2194	2281	2364	2446	2524	2616	2994	3281

Connecting Tables Page 7
 Tandem Seating Pages 8-9

OPTIONS		
-PFW01	Premium Wood Finish, Arm Cap (per arm)	12
-PFW03	Premium Wood Finish, Frame	34
-CO01	Corian Arm Cap (per arm)	84
-SC02	Replaceable Seat Cover	84
-BC02	Replaceable Back Cover	64
-MB02	Moisture Barrier	133
-NS04	Non-Skid Glides	29

REPRISE WOOD GUEST + TANDEM // DESIGNED BY DAVID DAHL

ORDERING GUIDELINES:

- » To build tandem configurations, always specify units from left-to-right as facing.
- » Starter units ('-ST') represent the first seating model in a configuration with subsequent modular units building onto them towards the right.
- » Add-On units ('-AO') can only be added next to Starter units or other Add-On units.
- » End-units ('-EU') represent the final seating model in a configuration.
- » Center tables are for inline placement only (cannot start or end a configuration) and includes arm frame for connecting purposes. To add seating units, subsequent chair will always be the 'AO' (add-on) or 'EU' (end unit).
- » **Bariatric tandem chairs cannot be adjoined together side-by-side.**
- » Refer page 4 for ordering requirements.

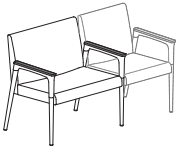
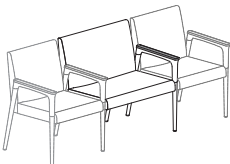
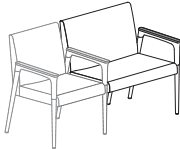

MODEL NUMBER	PRODUCT SPECIFICATIONS	FABRIC GRADES										LEATHER			
		COM	A	1	2	COL		3	4	5	6	7	8	L1	L2
3440-ST-UB (BLACK) 3440-ST-UG (GREY) 	Tandem Bariatric Starter Unit 34" Wide, Urethane Arm Caps W 34 D 25 ¹ / ₂ H 33 ¹ / ₂ Seat Height 18 Inside Seat Width 30 Inside Seat Depth 19 Arm Height 25 ¹ / ₂ 2 ¹ / ₂ yds. 45 lbs. COL 50 sq. ft.	2199	2362	2442	2492	2572	2659	2742	2824	2902	2994	3372	3659		
3440-AO-UB (BLACK) 3440-AO-UG (GREY) 	Tandem Bariatric Add-On Unit 34" Wide, Urethane Arm Cap W 32 D 25 ¹ / ₂ H 33 ¹ / ₂ Seat Height 18 Inside Seat Width 30 Inside Seat Depth 19 Arm Height 25 ¹ / ₂ 2 ¹ / ₂ yds. 41 lbs. COL 50 sq. ft.	1885	2048	2128	2178	2258	2345	2428	2510	2588	2680	3058	3345		
3440-EU-UB (BLACK) 3440-EU-UG (GREY) 	Tandem Bariatric End Unit 34" Wide, Urethane Arm Cap W 32 D 25 ¹ / ₂ H 33 ¹ / ₂ Seat Height 18 Inside Seat Width 30 Inside Seat Depth 19 Arm Height 25 ¹ / ₂ 2 ¹ / ₂ yds. 41 lbs. COL 50 sq. ft.	1885	2048	2128	2178	2258	2345	2428	2510	2588	2680	3058	3345		
	Connecting Tables Page 7 Tandem Seating Pages 8-9														

OPTIONS		
-PFW03	Premium Wood Finish, Frame	34
-SC02	Replaceable Seat Cover (per seat)	84
-BC02	Replaceable Back Cover (per back)	64
-MB02	Moisture Barrier (seat only, per seat)	133
-NS02	Non-Skid Glides (per arm frame)	15

REPRISE WOOD GUEST + TANDEM // DESIGNED BY DAVID DAHL

ORDERING GUIDELINES:

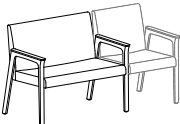
- » To build tandem configurations, always specify units from left-to-right as facing.
- » Starter units ('-ST') represent the first seating model in a configuration with subsequent modular units building onto them towards the right.
- » Add-On units ('-AO') can only be added next to Starter units or other Add-On units.
- » End-units ('-EU') represent the final seating model in a configuration.
- » Center tables are for inline placement only (cannot start or end a configuration) and includes arm frame for connecting purposes. To add seating units, subsequent chair will always be the 'AO' (add-on) or 'EU' (end unit).
- » **Bariatric tandem chairs cannot be adjoined together side-by-side.**
- » For Corian arm caps, please specify "-CO" in place of the "-W" after model number (with color selection) and refer to options below for upcharge.
- » Refer page 3 for ordering requirements.

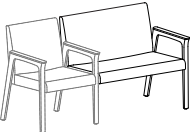
MODEL NUMBER	PRODUCT SPECIFICATIONS	FABRIC GRADES										LEATHER				
		COM	A	1	2	COL					3	4	5	6	7	8
3445-ST-W 	Tandem Bariatric Starter Unit 40" Wide, Wood Arm Caps W 40 D 25 ¹ / ₂ H 33 ¹ / ₂ Seat Height 18 Inside Seat Width 33 Inside Seat Depth 19 Arm Height 25 ¹ / ₂ 2 ¹ / ₂ Yds. 68 lbs. COL 50 sq. ft.	2418	2581	2661	2711	2791	2878	2961	3043	3121	3213	3591	3878			
3445-AO-W 	Tandem Bariatric Add-On Unit 40" Wide, Wood Arm Cap W 38 D 25 ¹ / ₂ H 33 ¹ / ₂ Seat Height 18 Inside Seat Width 33 Inside Seat Depth 19 Arm Height 25 ¹ / ₂ 2 ¹ / ₂ Yds. 64 lbs. COL 50 sq. ft.	2122	2285	2365	2415	2495	2582	2665	2747	2825	2917	3295	3582			
3445-EU-W 	Tandem Bariatric End Unit 40" Wide, Wood Arm Cap W 38 D 25 ¹ / ₂ H 33 ¹ / ₂ Seat Height 18 Inside Seat Width 33 Inside Seat Depth 19 Arm Height 25 ¹ / ₂ 2 ¹ / ₂ Yds. 64 lbs. COL 50 sq. ft.	2122	2285	2365	2415	2495	2582	2665	2747	2825	2917	3295	3582			



Connecting Tables Page 7
 Tandem Seating Pages 8-9

OPTIONS		
-PFW01	Premium Wood Finish, Arm Cap (per arm)	12
-PFW03	Premium Wood Finish, Frame	34
-CO01	Corian Arm Cap (per arm)	84
-SC02	Replaceable Seat Cover	84
-BC02	Replaceable Back Cover	64
-MB02	Moisture Barrier	133
-NS04	Non-Skid Glides	29

REPRISE WOOD GUEST + TANDEM // DESIGNED BY DAVID DAHL

ORDERING GUIDELINES:

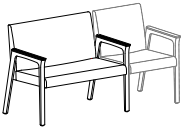
- » To build tandem configurations, always specify units from left-to-right as facing.
- » Starter units ('-ST') represent the first seating model in a configuration with subsequent modular units building onto them towards the right.
- » Add-On units ('-AO') can only be added next to Starter units or other Add-On units.
- » End-units ('-EU') represent the final seating model in a configuration.
- » Center tables are for inline placement only (cannot start or end a configuration) and includes arm frame for connecting purposes. To add seating units, subsequent chair will always be the 'AO' (add-on) or 'EU' (end unit).
- » **Bariatric tandem chairs cannot be adjoined together side-by-side.**
- » Refer page 4 for ordering requirements.

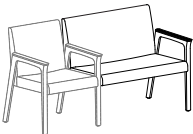
MODEL NUMBER	PRODUCT SPECIFICATIONS	FABRIC GRADES										LEATHER				
		COM	A	1	2	COL					3	4	5	6	7	8
3445-ST-UB (BLACK) 3445-ST-UG (GREY) 	Tandem Bariatric Starter Unit 40" Wide, Urethane Arm Caps W 40 D 25 ¹ / ₂ H 33 ¹ / ₂ Seat Height 18 Inside Seat Width 33 Inside Seat Depth 19 Arm Height 25 ¹ / ₂ 2 ¹ / ₂ yds. 68 lbs. COL 50 sq. ft.	2482	2645	2725	2775	2855	2942	3025	3107	3185	3277	3655	3942			
3445-AO-UB (BLACK) 3445-AO-UG (GREY) 	Tandem Bariatric Add-On Unit 40" Wide, Urethane Arm Cap W 38 D 25 ¹ / ₂ H 33 ¹ / ₂ Seat Height 18 Inside Seat Width 33 Inside Seat Depth 19 Arm Height 25 ¹ / ₂ 2 ¹ / ₂ yds. 64 lbs. COL 50 sq. ft.	2186	2349	2429	2479	2559	2646	2729	2811	2889	2981	3359	3646			
3445-EU-UB (BLACK) 3445-EU-UG (GREY) 	Tandem Bariatric End Unit 40" Wide, Urethane Arm Cap W 38 D 25 ¹ / ₂ H 33 ¹ / ₂ Seat Height 18 Inside Seat Width 33 Inside Seat Depth 19 Arm Height 25 ¹ / ₂ 2 ¹ / ₂ yds. 64 lbs. COL 50 sq. ft.	2186	2349	2429	2479	2559	2646	2729	2811	2889	2981	3359	3646			

Connecting Tables Page 7
Tandem Seating Pages 8-9

OPTIONS		
-PFW03	Premium Wood Finish, Frame	34
-SC02	Replaceable Seat Cover (per seat)	84
-BC02	Replaceable Back Cover (per back)	64
-MB02	Moisture Barrier (seat only, per seat)	133
-NS02	Non-Skid Glides (per arm frame)	15

REPRISE WOOD GUEST + TANDEM // DESIGNED BY DAVID DAHL

CONFIGURATION EXAMPLES:

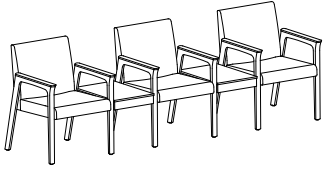

Qty	Model #	Description	COM List
1	3420-ST-W	Tandem Starter Unit	\$1,720
2	3417-15	15" Center Inline Table (\$956 each)	\$1,912
1	3420-AO-W	Tandem Add-On Unit	\$1,510
1	3420-EU-W	Tandem End Unit	\$1,510
			<u>\$6,652</u>

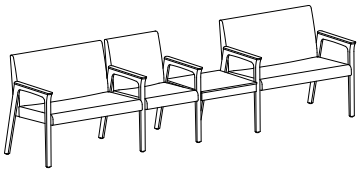

Qty	Model #	Description	COM List
1	3440-ST-W	Tandem 34" Wide Bariatric Starter Unit	\$2,135
1	3420-AO-W	Tandem Add-On Unit	\$1,510
1	3417-21	21" Center Inline Table	\$1,084
1	3440-EU-W	34" Wide Bariatric End Unit	\$1,821
			<u>\$6,550</u>

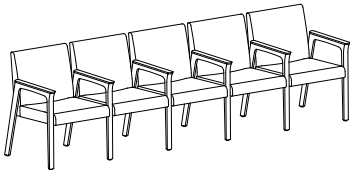

Qty	Model #	Description	COM List
1	3420-ST-W	Tandem Starter Unit	\$1,720
3	3420-AO-W	Tandem Add-On Unit (\$1,510 each)	\$4,530
1	3420-EU-W	Tandem End Unit	\$1,510
			<u>\$7,760</u>

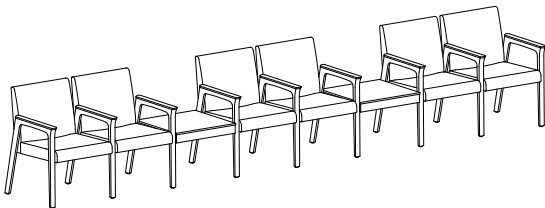

Qty	Model #	Description	COM List
1	3420-ST-W	Tandem Starter Unit	\$1,720
4	3420-AO-W	Tandem Add-On Unit (\$1,510 each)	\$6,040
2	3417-21	21" Center Inline Table (\$1,084 each)	\$2,168
1	3420-EU-W	Tandem End Unit	\$1,510
			<u>\$11,438</u>

REPRISE WOOD GUEST + TANDEM // DESIGNED BY DAVID DAHL

ORDERING REQUIREMENTS:

- » Model number
- » Upholstery selection
- » Arm cap finish
- » Options, as applicable
- » Wood frame finish

Note: For Corian arm caps, specify '-CO' in place of '-W' after model number and refer to options below for upcharge.

MODEL NUMBER	PRODUCT SPECIFICATIONS	FABRIC GRADES										LEATHER			
		COM	A	1	2	COL		3	4	5	6	7	8	L1	L2
3450-W	Patient Chair Wood Arm Caps W 24 ¹ / ₂ D 25 ¹ / ₂ H 44 Seat Height 18 Inside Seat Width 20 Inside Seat Depth 19 Arm Height 25 ¹ / ₂ 2 ¹ / ₄ yds. 37 lbs. COL 45 sq. ft.	1861	2008	2080	2125	2197	2275	2350	2424	2494	2577	2917	3175		
3450-UB (BLACK) 3450-UG (GREY)	Patient Chair Urethane Arm Caps W 24 ¹ / ₂ D 25 ¹ / ₂ H 44 Seat Height 18 Inside Seat Width 20 Inside Seat Depth 19 Arm Height 25 ¹ / ₂ 2 ¹ / ₄ yds. 37 lbs. COL 45 sq. ft.	1925	2072	2144	2189	2261	2339	2414	2488	2558	2641	2981	3239		

OPTIONS



-PFW01	Premium Wood Finish, Arm Cap (per arm)	12
-PFW03	Premium Wood Finish, Frame	34
-CO01	Corian Arm Cap (per arm)	84
-SC01	Replaceable Seat Cover (per seat)	64
-BC01	Replaceable Back Cover (per back)	42
-MB01	Moisture Barrier (seat only, per seat)	69
-NS04	Non-Skid Glides	29

REPRISE WOOD GUEST + TANDEM // DESIGNED BY DAVID DAHL

ORDERING REQUIREMENTS:

- » Model number
- » Upholstery selection
- » Arm cap finish
- » Options, as applicable
- » Wood frame finish

Note: For Corian arm caps, specify '-CO' in place of '-W' after model number and refer to options below for upcharge.

MODEL NUMBER	PRODUCT SPECIFICATIONS	FABRIC GRADES										LEATHER			
		COM	A	1	2	COL		3	4	5	6	7	8	L1	L2
3457-W 	Easy Access/Hip Chair Wood Arm Caps W 24 ¹ / ₂ D 25 ¹ / ₂ H 39 ¹ / ₂ Seat Height 25 Inside Seat Width 20 Inside Seat Depth 19 Arm Height 32 ¹ / ₂ 1 ¹ / ₂ yds. 40 lbs. COL 30 sq. ft.	2145	2243	2291	2321	2369	2421	2471	2520	2567	2622	2849	3021		
3457-UB (BLACK) 3457-UG (GREY) 	Easy Access/Hip Chair Urethane Arm Caps W 24 ¹ / ₂ D 25 ¹ / ₂ H 39 ¹ / ₂ Seat Height 25 Inside Seat Width 20 Inside Seat Depth 19 Arm Height 32 ¹ / ₂ 1 ¹ / ₂ yds. 40 lbs. COL 30 sq. ft.	2209	2307	2355	2385	2433	2485	2535	2584	2631	2686	2913	3085		



OPTIONS

-PFW01	Premium Wood Finish, Arm Cap (per arm)	12
-PFW03	Premium Wood Finish, Frame	34
-CO01	Corian Arm Cap (per arm)	84
-SC01	Replaceable Seat Cover (per seat)	64
-BC01	Replaceable Back Cover (per back)	42
-MB01	Moisture Barrier (seat only, per seat)	69
-NS04	Non-Skid Glides	29

REPRISE WOOD GUEST + TANDEM // DESIGNED BY DAVID DAHL

PRODUCT FEATURES:

- » Concealed velcro attachment.
- » Replacement seat and back covers can be easily field installed on previously ordered Reprise Wood models with replaceable cover option.
- » Reprise models originally ordered with standard fixed upholstery can utilize replacement seat and/or back covers, however some upholstery work will be required to remove original upholstery covers.

MODEL NUMBER	PRODUCT SPECIFICATIONS	FABRIC GRADES										LEATHER	
		COM	A	1	2	COL 3	4	5	6	7	8	L1	L2
RSC-3410 	Replacement Upholstered Seat Cover 1 yd. COL 20 sq. ft.	179	244	276	296	328	363	396	429	460	497	648	763
	Applies to: 3410 Guest 3420 Tandem 3450 Patient Chair 3457 Easy Access/Hip Chair												
RBC-3410 	Replacement Upholstered Back Cover 1 yd. COL 20 sq. ft.	202	267	299	319	351	386	419	452	483	520	671	786
	Applies to: 3410 Guest 3420 Tandem 3457 Hip Chair												

OPTIONS

-MB01	Moisture Barrier (seat only, per seat)	69
-------	--	----

REPRISE WOOD GUEST + TANDEM // DESIGNED BY DAVID DAHL

PRODUCT FEATURES:

- » Concealed velcro attachment.
- » Replacement seat and back covers can be easily field installed on previously ordered Reprise Wood models with replaceable cover option.
- » Reprise models originally ordered with standard fixed upholstery can utilize replacement seat and/or back covers, however some upholstery work will be required to remove original upholstery covers.

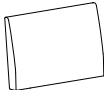
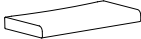
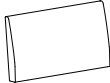
MODEL NUMBER	PRODUCT SPECIFICATIONS	FABRIC GRADES										LEATHER			
		COM	A	1	2	COL		3	4	5	6	7	8	L1	L2
RSC-3440 	34" Wide Bariatric Settee Replacement Upholstered Seat Cover 1 yd. COL 20 sq. ft.	248	313	345	365	397	432	465	498	529	566	717	832		
RBC-3440 	34" Wide Bariatric Settee Replacement Upholstered Back Cover 1 1/2 yds. COL 30 sq. ft.	248	346	394	424	472	524	574	623	670	725	952	1124		
RSC-3445 	40" Wide Bariatric Settee Replacement Upholstered Seat Cover 1 1/4 yds. COL 25 sq. ft.	248	330	370	395	435	478	520	561	600	646	835	978		
RBC-3445 	40" Wide Bariatric Settee Replacement Upholstered Back Cover 1 1/2 yds. COL 30 sq. ft.	202	267	299	319	351	386	419	452	483	520	671	786		



OPTIONS

-MB02	Moisture Barrier (seat only, per seat)	133
-------	--	-----

REPRISE WOOD GUEST + TANDEM // DESIGNED BY DAVID DAHL

PRODUCT FEATURES:

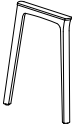
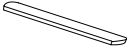
- » Replacement hardware included with replacement frames.

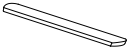
MODEL NUMBER	PRODUCT SPECIFICATIONS	LIST
3410-05R (RIGHT ARM, AS SEATED) 3410-05C (CENTER ARM, AS SEATED) 3410-05L (LEFT ARM, AS SEATED)	Replacement Guest Chair No Arm Cap 8 lbs.	329
		
3410-07W (WOOD)	Replacement Wood Arm Cap 2 lbs.	177
		
3410-07UB (BLACK) 3410-07UG (GREY)	Replacement Urethane Arm Cap, Black or Grey 2 lbs.	152
		
3410-07C (CORIAN)	Replacement Corian Arm Cap (standard colors only) 2 lbs.	281
		

OPTIONS		
-PFW01	Premium Wood Finish, Arm Cap (per arm)	12
-PFW02	Premium Wood Finish (per arm frame)	22
-NS02	Non-Skid Glides	15

REPRISE WOOD GUEST + TANDEM // DESIGNED BY DAVID DAHL

UPHOLSTERY COMBINATIONS:

- » When combining two COM/COV/COL fabrics, or fabrics with the same grade, add \$120 List per unit.
- » When combining three COM/COV/COL fabrics, or fabrics with the same grade, add \$150 List per unit.
- » When combining different grades of fabric, price will be based on the highest grade specified.
- » Two-tone upholstery examples and yardage requirements for the most common combinations are listed below. Additional combinations available, please contact client services for yardage requirements and pricing.
- » Note: Yardage amounts are based on fabric which is plain (i.e. non-directional) and a full 54" wide.
- » Appropriate upholstery code must be included.



Code	RE1
<u>Models</u>	<u>COM Requirement</u>
All Guest & Easy Access/Hip Chair Units	Seat = 1 yd. Back = 1 yd.



Code	RE2
<u>Models</u>	<u>COM Requirement</u>
All 34" W Bariatric Units	Seat = 1 yd. Back = 1 ¹ / ₂ yds.

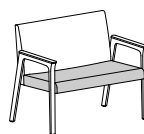

Code	RE3
<u>Models</u>	<u>COM Requirement</u>
All 40" W Bariatric Units	Seat = 1 ¹ / ₄ yds. Back = 1 ¹ / ₂ yds.



Code	RE4
<u>Models</u>	<u>COM Requirement</u>
3450-W 3450-U	Seat = 1 ¹ / ₄ yds. Back = 2 ¹ / ₄ yds.

SCENERY SEATING



MARCH 1, 2026
VA IDIQ CONTRACT (FY26)
(DEALER HELD)

SCENERY LOUNGE + MODULAR // DESIGNED BY 5D STUDIO



PRODUCT FEATURES:

- » Modular configurations comprised of lounge, love seat and sofa models in addition to corner units and benches.
- » Models with upholstered ledge along the back perimeter provide perching support as well as additional workspace choices. Ledge depth is 9", with maximum weight capacity of 275 lbs. for lounge units, and 500 lbs. for love seats and sofas.
- » Optional wood bridge is suspended between armless models with the upholstered ledge and must be specified with a bench. Bridge maximum weight capacity is 200 lbs.
- » Bench units are directional.
- » Corner units are for ganging applications only (leg formation does not allow it to stand up on its own). Ganging brackets included.
- » Refer to page 10-13 for power unit options and standard placement locations.
- » Units that require cartoning will ship KD (legs will need to be field-installed). For blanket-wrap shipments, legs will be attached.
- » All dimensions are nominal.

MODULAR ARRANGEMENTS:

- » One ganging bracket connects two units together.
- » For units attaching to benches with connecting bridges, ganging brackets are required.
- » **Note: Please include layout drawings or sketch with order.**
- » Field assembly required.



SPECIFICATIONS:

- » Upholstery direction must be specified on corner units when patterned fabrics are selected. In the absence of specific instructions, Arcadia reserves the right to upholster units at our discretion.

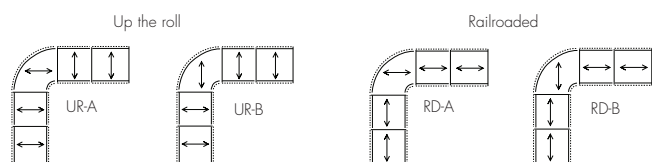

- » Wood bridge available in ash and walnut veneer, with solid wood edge on the inside perimeter and exposed plywood edge on the outside perimeter. Edge finish will match veneer finish selection.
- » For Alabaster and Super Matte Sable Ash, premium wood finish upcharge applies. Refer to options section for pricing.
- » For custom wood finishes, please add one-time upcharge of \$514 List per color per order.
- » Laminate bridge tops also available. Edge facing the inside is post-formed to deliver a seamless finish from the top surface to the edge underside. Edge facing the outside is exposed plywood edge.

SCENERY LOUNGE + MODULAR // DESIGNED BY 5D STUDIO

SPECIFICATIONS CONTINUED:

- » For standard wood grain and solid black laminates, exposed plywood edge will be finished to match.
- » For all other standard solid color laminates, exposed plywood edge will be natural (clear coat) as standard, unless otherwise specified.
- » Edges are also available in all standard wood finishes, please specify. For custom edge finishes (e.g. to match standard solid color laminates), please add one-time upcharge of \$514 List per color, per order.
- » For custom laminates, add \$642 List per color per order. Please note that selection must have post-forming capabilities. Pre-approval required, please contact client services.
- » Wood grain direction will run lengthwise.
- » Die-cast aluminum legs available in standard and premium finishes.

STANDARD METAL LEG FINISHES:

- » 0299 Polished Aluminum
- » 0405 Charcoal Grey
- » 0535 Metallic Silver
- » 0630 Satin Black

PREMIUM METAL LEG FINISHES:

- » 0605 Matte Black
- » 0705 Matte Cotton
- » 0788 Glossy Cotton
- » 0805 Oasis
- » 0905 Mint
- » 1005 Mercury
- » 1105 Canary
- » 1205 Stone
- » 1305 Sage
- » 1405 Ice Blue
- » 1505 Clay

ORDERING REQUIREMENTS:

- » Model number
- » Metal leg finish
- » Upholstery selection
- » Wood bridge finish, as applicable
- » Options, as applicable

SCENERY LOUNGE + MODULAR // DESIGNED BY 5D STUDIO

ORDERING REQUIREMENTS:

- » Model number
- » Upholstery selection
- » Leg finish
- » Options, as applicable

Note: Models below cannot be ganged.

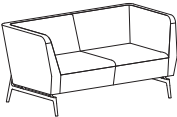
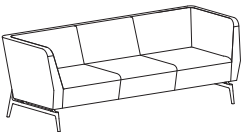



MODEL NUMBER	PRODUCT SPECIFICATIONS	FABRIC GRADES										LEATHER	
		COM	A	1	2	COL		3	4	5	6	7	8
6401 	Lounge Chair W 33 ¹ / ₂ D 30 ¹ / ₂ H 29 Seat Height 17 Inside Seat Width 20 Inside Seat Depth 22 4 ¹ / ₄ yds. 53 lbs. COL 85 sq. ft.	2722	2999	3135	3220	3356	3504	3645	3785	3917	4074	4716	5204
6402 	Love Seat W 57 ¹ / ₂ D 30 ¹ / ₂ H 29 Seat Height 17 Inside Seat Width 44 Inside Seat Depth 22 5 ¹ / ₂ yds. 73 lbs. COL 110 sq. ft.	3751	4109	4285	4395	4571	4763	4945	5126	5297	5500	6331	6963
6403 	Sofa W 81 ¹ / ₂ D 30 ¹ / ₂ H 29 Seat Height 17 Inside Seat Width 68 Inside Seat Depth 22 6 ³ / ₄ yds. 95 lbs. COL 135 sq. ft.	4692	5131	5347	5482	5698	5934	6157	6380	6589	6839	7858	8634

OPTIONS		
-PFM02	Premium Metal Finish	111
-NS04	Non-Skid Glides	29

SCENERY LOUNGE + MODULAR // DESIGNED BY 5D STUDIO

ORDERING REQUIREMENTS:

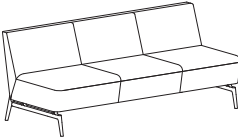
- » Model number
- » Metal leg finish
- » Upholstery selection
- » Options, as applicable

MODEL NUMBER	PRODUCT SPECIFICATIONS	FABRIC GRADES										LEATHER			
		COM	A	1	2	COL		3	4	5	6	7	8	L1	L2
6410 	Armless Lounge Chair W 24 D 30 ¹ / ₂ H 29 Seat Height 17 Inside Seat Width 24 Inside Seat Depth 22 2 ³ / ₄ yds. 39 lbs. COL 45 sq. ft.	2153	2300	2372	2417	2489	2567	2642	2716	2786	2869	3209	3467		
6420 	Armless Love Seat W 48 D 30 ¹ / ₂ H 29 Seat Height 17 Inside Seat Width 48 Inside Seat Depth 22 3 ¹ / ₂ yds. 60 lbs. COL 70 sq. ft.	3179	3407	3519	3589	3701	3823	3939	4054	4163	4292	4821	5223		
6430 	Armless Sofa W 72 D 30 ¹ / ₂ H 29 Seat Height 17 Inside Seat Width 72 Inside Seat Depth 22 5 ¹ / ₄ yds. 82 lbs. COL 105 sq. ft.	4132	4474	4642	4747	4915	5098	5272	5445	5608	5802	6595	7198		
6440 	Corner Unit* W 29 ¹ / ₂ D 29 ¹ / ₂ H 29 Seat Height 17 Inside Seat Width 22 ¹ / ₄ Inside Seat Depth 22 ¹ / ₄ 2 ³ / ₄ yds. 55 lbs. COL 55 sq. ft.	2674	2853	2941	2996	3084	3180	3271	3362	3447	3549	3964	4280		



*Includes ganging connectors.

OPTIONS		
-PFM02	Premium Metal Finish	111
-NS04	Non-Skid Glides	29
GC08 (ordered separately)	Ganging Connector	102

SCENERY LOUNGE + MODULAR // DESIGNED BY 5D STUDIO

ORDERING REQUIREMENTS:

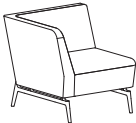
- » Model number
- » Metal leg finish
- » Upholstery selection
- » Options, as applicable



MODEL NUMBER	PRODUCT SPECIFICATIONS	FABRIC GRADES										LEATHER	
		COM	A	1	2	COL		3	4	5	6	7	8
6410-R 	Single Seat, Right Arm as Seated W 29 D 30 ¹ / ₂ H 29 Seat Height 17 Inside Seat Width 24 Inside Seat Depth 22 2 ³ / ₄ yds. 60 lbs. COL 55 sq. ft.	2660	2839	2927	2982	3070	3166	3257	3348	3433	3535	3950	4266
		2660	2839	2927	2982	3070	3166	3257	3348	3433	3535	3950	4266
6410-L 	Single Seat, Left Arm as Seated W 29 D 30 ¹ / ₂ H 29 Seat Height 17 Inside Seat Width 24 Inside Seat Depth 22 2 ³ / ₄ yds. 60 lbs. COL 55 sq. ft.	2660	2839	2927	2982	3070	3166	3257	3348	3433	3535	3950	4266
		2660	2839	2927	2982	3070	3166	3257	3348	3433	3535	3950	4266

OPTIONS		
-PFM02	Premium Metal Finish	111
-NS04	Non-Skid Glides	29
GC08 (ordered separately)	Ganging Connector	102

SCENERY LOUNGE + MODULAR // DESIGNED BY 5D STUDIO

ORDERING REQUIREMENTS:

- » Model number
- » Metal leg finish
- » Upholstery selection
- » Options, as applicable

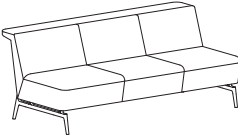
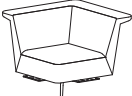
MODEL NUMBER	PRODUCT SPECIFICATIONS	FABRIC GRADES										LEATHER	
		COM	A	1	2	COL		3	4	5	6	7	8
6411 	Armless Lounge Chair with Ledge W 24 D 35 ¹ / ₄ H 29 Seat Height 17 Inside Seat Width 24 Inside Seat Depth 22 2 ³ / ₄ yds. 42 lbs. COL 55 sq. ft.	2345	2524	2612	2667	2755	2851	2942	3033	3118	3220	3635	3951
6421 	Armless Love Seat with Ledge W 48 D 35 ¹ / ₄ H 29 Seat Height 17 Inside Seat Width 48 Inside Seat Depth 22 4 yds. 68 lbs. COL 80 sq. ft.	3351	3611	3739	3819	3947	4087	4219	4351	4475	4623	5227	5687
6431 	Armless Sofa with Ledge W 72 D 35 ¹ / ₄ H 29 Seat Height 17 Inside Seat Width 72 Inside Seat Depth 22 5 ¹ / ₄ yds. 94 lbs. COL 105 sq. ft.	4316	4658	4826	4931	5099	5282	5456	5629	5792	5986	6779	7382
6441 	Corner Unit with Ledge* W 35 ¹ / ₄ D 35 ¹ / ₄ H 29 Seat Height 17 Inside Seat Width 22 ¹ / ₄ Inside Seat Depth 22 ¹ / ₄ 3 ³ / ₄ yds. 60 lbs. COL 75 sq. ft.	2975	3219	3339	3414	3534	3665	3789	3913	4029	4168	4734	5165

*Includes ganging connectors.

OPTIONS		
-PFM02	Premium Metal Finish	111
-NS04	Non-Skid Glides	29
GC08 (ordered separately)	Ganging Connector	102

SCENERY LOUNGE + MODULAR // DESIGNED BY 5D STUDIO

ORDERING REQUIREMENTS:

- » Model number
- » Metal leg finish
- » Upholstery selection
- » Options, as applicable

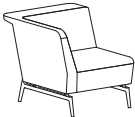
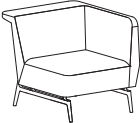

MODEL NUMBER	PRODUCT SPECIFICATIONS	FABRIC GRADES										LEATHER				
		COM	A	1	2	COL					3	4	5	6	7	8
6411-R 	Single Seat, Right Arm as Seated W 29 D 35 ¹ / ₄ H 29 Seat Height 17 Inside Seat Width 24 Inside Seat Depth 22 3 ¹ / ₄ yds. 65 lbs. COL 65 sq. ft.	2836	3048	3152	3217	3321	3434	3542	3649	3750	3870	4361	4734			
		2836	3048	3152	3217	3321	3434	3542	3649	3750	3870	4361	4734			
6411-L 	Single Seat, Left Arm as Seated W 29 D 35 ¹ / ₄ H 29 Seat Height 17 Inside Seat Width 24 Inside Seat Depth 22 3 ¹ / ₄ yds. 65 lbs. COL 65 sq. ft.	2836	3048	3152	3217	3321	3434	3542	3649	3750	3870	4361	4734			
		2836	3048	3152	3217	3321	3434	3542	3649	3750	3870	4361	4734			

OPTIONS		
-PFM02	Premium Metal Finish	111
-NS04	Non-Skid Glides	29
GC08 (ordered separately)	Ganging Connector	102

SCENERY LOUNGE + MODULAR // DESIGNED BY 5D STUDIO

ORDERING REQUIREMENTS:

- » Model number
- » Upholstery selection
- » Leg finish
- » Options, as applicable
- » **Note: Bench units are directional**

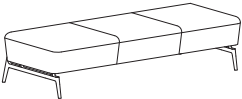
MODEL NUMBER	PRODUCT SPECIFICATIONS	FABRIC GRADES										LEATHER	
		COM	A	1	2	COL		3	4	5	6	7	8
6461 	Single Seat Bench W 24 D 30 ¹ / ₂ H 17 1 ¹ / ₂ yds. 32 lbs. COL 30 sq. ft.	1684	1782	1830	1860	1908	1960	2010	2059	2106	2161	2388	2560
6462 	Two-Seat Bench W 48 D 30 ¹ / ₂ H 17 2 ¹ / ₄ yds. 48 lbs. COL 45 sq. ft.	2293	2440	2512	2557	2629	2707	2782	2856	2926	3009	3349	3607
6463 	Three-Seat Bench W 72 D 30 ¹ / ₂ H 17 3 yds. 64 lbs. COL 60 sq. ft.	2930	3125	3221	3281	3377	3482	3581	3680	3773	3884	4337	4682

OPTIONS		
-PFM02	Premium Metal Finish	111
-NS04	Non-Skid Glides	29
GC08 (ordered separately)	Gangng Connector	102



SCENERY LOUNGE + MODULAR // DESIGNED BY 5D STUDIO

ORDERING REQUIREMENTS:

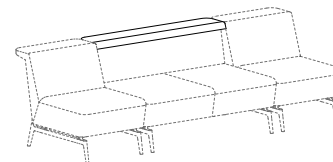
- » Model number
- » Wood species
- » Wood finish



Note: Must be specified with bench unit for stability purposes. Please include layout drawings Include layout drawings or sketch with order

MODEL NUMBER	PRODUCT SPECIFICATIONS	VENEER OR LAMINATE
<p>6448</p> 	<p>48" Wide Bridge Depth: 9" Thickness: 2"</p>	<p>1161</p>
<p>6472</p> 	<p>72" Wide Bridge Depth: 9" Thickness: 2"</p>	<p>1399</p>

OPTIONS





-PFW02	Premium Wood Finish	22
--------	---------------------	----

SCENERY LOUNGE + MODULAR // DESIGNED BY 5D STUDIO

ORDERING REQUIREMENTS:

- » Power unit model number should follow applicable seating model number.

Note: No hardwire option available for this series.

MODEL NUMBER	PRODUCT SPECIFICATIONS	LIST
<p>IUR-B (BLACK FINISH) IUR-G (GREY FINISH) IUR-W (WHITE FINISH)</p> 	<p>Integrated USB Unit</p> <ul style="list-style-type: none"> » Dimensions: 1³/₄" Diameter » Black, grey or white finish » Dual USB charging ports » 72" electrical cord (only length available) » UL listed » Integrated placement on seat end units or any seat back, refer to page 12 for standard locations 	320
<p>IPR-B (BLACK FINISH) IPR-G (GREY FINISH) IPR-W (WHITE FINISH)</p> 	<p>Integrated Power Unit</p> <ul style="list-style-type: none"> » Dimensions: 1³/₄" Diameter » Black, grey or white finish » One (1) simplex outlet » 72" electrical cord (only length available) » UL listed » Integrated placement on seat end units or any seat back, refer to page 12 for standard locations 	320
<p>USB1-B (BLACK FINISH)</p> 	<p>USB Charging Dock 1</p> <ul style="list-style-type: none"> » Dimensions: 1" W x 1¹/₄" D x 3³/₄" H » Black finish » 5V DC 2.1A (10.5 watts) USB charging port with blue LED back lighting » 96" electrical cord (only length available) » UL listed » Placement can be below any seating unit » Unit is positioned 3" from left or right edge as well as centered, please specify location (left, center or right, as seated) 	135
<p>USB3-B (BLACK FINISH)</p> 	<p>USB Charging Dock 3</p> <ul style="list-style-type: none"> » Dimensions: 2¹/₂" W x 1¹/₂" D x 3³/₄" H » Black finish » One (1) USB-A and one (1) USB-C charging ports with blue LED back lighting » 96" electrical cord (only length available) » UL listed » Placement can be below any seating unit » Unit is positioned 3" from left or right edge as well as centered, please specify location (left, center or right, as seated) 	179

SCENERY LOUNGE + MODULAR // DESIGNED BY 5D STUDIO

ORDERING REQUIREMENTS:

- » Power unit model number should follow applicable seating model number.

Note: No hardwire option available for this series.

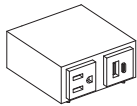
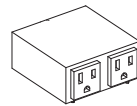
MODEL NUMBER	PRODUCT SPECIFICATIONS	LIST
<p>MT3-B (BLACK FINISH) MT3-W (WHITE FINISH)</p> 	<p>Mini-Tap 3</p> <ul style="list-style-type: none"> » Dimensions: 3" W x 3" D x 1³/₄" H » Black or white finish » One (1) simplex outlet, one (1) USB-A and one (1) USB-C charging port » 72" electrical cord (only length available) » UL listed » Placement can be below any seating unit » Unit is positioned 3" from left or right edge as well as centered, please specify location (left, center or right, as seated) 	<p>399</p>
<p>MT2-B (BLACK FINISH) MT2-W (WHITE FINISH)</p> 	<p>Mini-Tap 2</p> <ul style="list-style-type: none"> » Dimensions: 3" W x 3" D x 1³/₄" H » Black or white finish » Two (2) simplex outlets » 72" electrical cord (only length available) » Placement can be below any seating unit » Unit is positioned 3" from left or right edge as well as centered, please specify location (left, center or right, as seated) 	<p>367</p>

SCENERY LOUNGE + MODULAR // DESIGNED BY 5D STUDIO

STANDARD POWER UNIT LOCATIONS:

» For Integrated USB and Integrated Power units, standard placement is as follows:

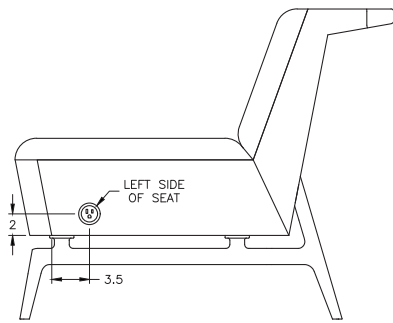

Side placement (armless models only)

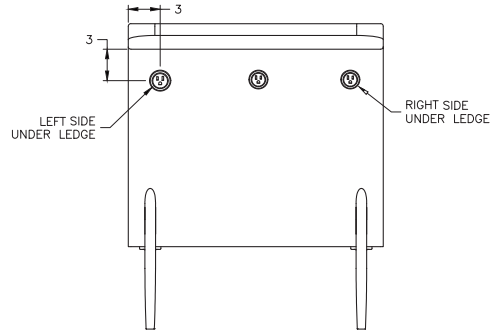

Back placement - specify left, center* or right, as facing back

*Center position not available on love seat models

SCENERY LOUNGE + MODULAR // DESIGNED BY 5D STUDIO

CONFIGURATION EXAMPLES:

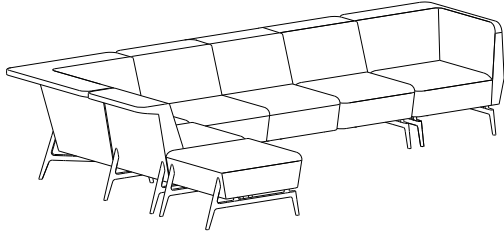

Qty	Model #	Description	COM List
1	6461	Single Seat Bench	\$1,684
1	6411	Armless Lounge Chair with Ledge	\$2,345
1	6441	Corner Unit with Ledge	\$2,975
1	6431	Armless Sofa with Ledge	\$4,316
1	6411-L	Single Seat, Left Arm	\$2,836
			\$14,156

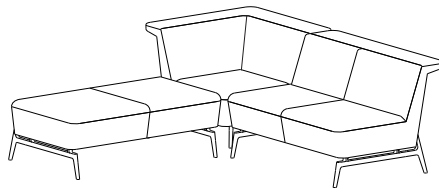

Qty	Model #	Description	COM List
1	6462	Two-Seat Bench	\$2,293
1	6441	Corner Unit with Ledge	\$2,975
1	6421	Armless Love Seat with Ledge	\$3,351
			\$8,619

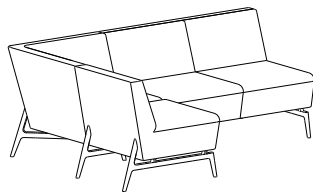

Qty	Model #	Description	COM List
1	6410	Armless Lounge Chair	\$2,153
1	6440	Corner Unit	\$2,674
1	6420	Armless Love Seat	\$3,179
			\$8,006

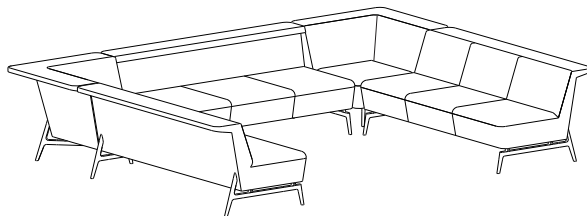

Qty	Model #	Description	COM List
2	6431	Armless Sofa with Ledge (\$4,316 each)	\$8,632
2	6441	Corner Unit with Ledge (\$2,975 each)	\$5,950
1	6472	72" Wide Wood Bridge	\$1,399
1	6463	Three-Seat Bench	\$2,930
			\$18,911

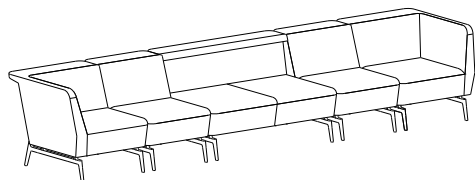

Qty	Model #	Description	COM List
1	6411-R	Single Seat, Right Arm	\$2,836
2	6411	Armless Lounge Chair with Ledge (\$2,345 each)	\$4,690
1	6448	48" Wide Wood Bridge	\$1,161
1	6462	Two-Seat Bench	\$2,293
1	6411-L	Single Seat, Left Arm	\$2,836
			\$13,816

Note: Scenery ganging connectors not included in pricing examples as shown above.

SCENERY LOUNGE + MODULAR // DESIGNED BY 5D STUDIO

UPHOLSTERY COMBINATIONS:

- » When combining two COM/COV/COL fabrics, or fabrics with the same grade, add \$120 List per unit.
- » When combining different grades of fabric, price will be based on the highest grade specified.
- » Two-tone upholstery examples and yardage requirements for the most common combinations are listed below. Additional combinations available, please contact client services for yardage requirements and pricing.
- » Note: Yardage amounts are based on fabric which is plain (i.e. non-directional) and a full 54" wide.
- » Appropriate upholstery code must be included.



Code SC1
Model 6401
COM Requirement
 Seat Cushion Only = 1 yd.
 Balance of Unit = 3¹/₂ yds.

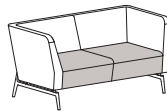

Code SC2
Model 6402
COM Requirement
 Seat Cushion Only = 1¹/₂ yds.
 Balance of Unit = 4¹/₄ yds.

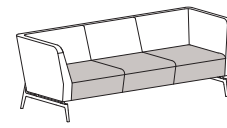

Code SC3
Model 6403
COM Requirement
 Seat Cushion Only = 2¹/₄ yds.
 Balance of Unit = 4³/₄ yds.



Code SC4
Model 6410
COM Requirement
 Seat Cushion = 1¹/₄ yds.
 Back Cushion = 1¹/₄ yds.



Code SC5
Model 6420
COM Requirement
 Seat Cushion Only = 1¹/₂ yds.
 Balance of Unit = 2¹/₄ yds.

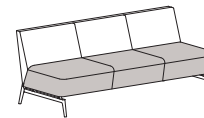

Code SC6
Model 6430
COM Requirement
 Seat Cushion Only = 2¹/₂ yds.
 Balance of Unit = 2³/₄ yds.



Code SC7
Model 6440
COM Requirement
 Seat Cushion = 1 yd.
 Back Cushion = 2¹/₂ yds.



Code SC8
Model 6410-R
 6410-L
COM Requirement
 Seat Cushion Only = 1 yd.
 Balance of Unit = 2¹/₂ yds.



Code SC9
Model 6411
COM Requirement
 Seat Cushion Only = 1¹/₄ yds.
 Balance of Unit = 1³/₄ yds.



Code SC10
Model 6421
COM Requirement
 Seat Cushion = 1¹/₂ yds.
 Back Cushion = 2³/₄ yds.

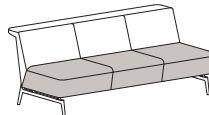

Code SC11
Model 6431
COM Requirement
 Seat Cushion Only = 2¹/₂ yds.
 Balance of Unit = 3³/₄ yds.



Code SC12
Model 6441
COM Requirement
 Seat Cushion Only = 1 yd.
 Balance of Unit = 3¹/₂ yds.



Code SC13
Model 6411-R
 6411-L
COM Requirement
 Seat Cushion Only = 1 yd.
 Balance of Unit = 2³/₄ yds.

SOA SEATING



arcadia

MARCH 1, 2026
VA IDIQ CONTRACT (FY26)
(DEALER HELD)

SOA GUEST + TANDEM // DESIGNED BY CLAUDIO BELLINI STUDIO



PRODUCT FEATURES:

- » All models feature clean-outs on all sides, including between seat and back, for maintenance ease.
- » Elliptical metal tube frame and radiused arm caps for smooth surface contact.
- » Wall-saver leg design.
- » Passive-flex back.
- » Field-replaceable components available, refer to pages 11-12.
- » To further extend the product life-cycle while contributing to sustainable alternatives, upholstered seat and/or upholstered back cushions can be returned to the factory for repurposing or recycling, with new replacements to be provided as ordered. Refer to page 11 for details.
- » All dimensions are nominal.

TANDEM + MODULAR FEATURES:

- » Available in two, three and four-seat models or as reconfigurable modular configurations.
- » To build modular configurations, always specify units from left-to-right, as facing.
- » Connecting tables can only be specified with modular configurations due to attachment requirements. As such, reconfigurability may be limited or additional connecting arm frames may be required. Please contact client services to verify.
- » Connecting tables available in beech veneer, laminate, Fenix or Corian.
- » Bariatric models are not available for modular configurations.
- » **Layout drawings or sketch must be included with each order.**
- » Arcadia will pre-assemble units at the factory to maximize shipping allowances and minimize field assembly.

SPECIFICATIONS:

- » Elliptical metal tube frame available in standard as well as premium finishes and features black glides.
- » Three arm cap options: beech wood, black urethane and Corian.
- » For Corian arm caps, please specify '-CO' in place of the '-W' after model number with color selection and refer to options for upcharge.
- » Wood arm caps, as well as veneer connecting tables, available in all standard and custom wood finishes on beech.
- » For Super Matte Sable Beech, premium wood finish upcharge applies. Refer to options section for pricing.
- » For custom wood finishes to arm caps and/or tables, please add one-time upcharge of \$514 List per color per order.
- » For custom laminates on connecting tables, add \$642 List per color per order. Pre-approval required, please contact client services.
- » Corian arm caps and connecting tables available in six standard colors. For non-standard colors, please contact client services for pricing.

SOA GUEST + TANDEM // DESIGNED BY CLAUDIO BELLINI STUDIO

STANDARD METAL FRAME FINISHES:

- » 0405 Charcoal Grey
- » 0535 Metallic Silver
- » 0630 Satin Black

PREMIUM METAL FRAME FINISHES:

- » 0605 Matte Black
- » 0705 Matte Cotton
- » 0788 Glossy Cotton
- » 0805 Oasis
- » 0905 Mint
- » 1005 Mercury
- » 1105 Canary
- » 1205 Stone
- » 1305 Sage
- » 1405 Ice Blue
- » 1505 Clay

CORIAN® COLORS:

- » CWN Designer White
- » CLN Linen
- » CTD Witch Hazel
- » CRC Rain Cloud
- » CGQ Grey Onyx
- » CSQ Stonique

FENIX® COLORS:

- » FJ0032 Bianco Kos
- » FJ0720 Nero Ingo
- » FJ0725 Grigio Efeso
- » FJ0718 Grigio Londra
- » FJ0724 Grigio Bromo

WEIGHT CAPACITY:

- » Guest Chair 500 lbs.
- » Easy Access/Hip Chair 500 lbs.
- » Preconfigured Tandem 500 lbs. per seat
- » Reconfigurable Tandem 500 lbs. per seat
- » Bariatric Settee 1000 lbs.





ORDERING REQUIREMENTS:

- » Model number
- » Arm cap selection and finish
- » Metal frame finish
- » Upholstery selection
- » Options, as applicable

SOA GUEST + TANDEM // DESIGNED BY CLAUDIO BELLINI STUDIO

ORDERING REQUIREMENTS:

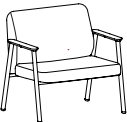
- » Model number
- » Arm cap selection and finish
- » Metal frame finish
- » Upholstery selection
- » Options, as applicable

MODEL NUMBER	PRODUCT SPECIFICATIONS	FABRIC GRADES										LEATHER	
		COM	A	1	2	COL		3	4	5	6	7	8
9210-W 	 Guest Chair Wood Arm Caps W 26 ¹ / ₂ D 29 H 35 Seat Height 18 ¹ / ₂ Inside Seat Width 21 Inside Seat Depth 19 ¹ / ₂ Arm Height 25 ³ / ₄ 2 ¹ / ₄ yds. 45 lbs. COL 45 sq. ft.	1663	1810	1882	1927	1999	2077	2152	2226	2296	2379	2719	2977
9236-W 	36" Wide Bariatric Settee Wood Arm Caps W 36 ¹ / ₂ D 29 H 35 Seat Height 18 ¹ / ₂ Inside Seat Width 31 Inside Seat Depth 19 ¹ / ₂ Arm Height 25 ³ / ₄ 3 yds. 61 lbs. COL 60 sq. ft.	2144	2339	2435	2495	2591	2696	2795	2894	2987	3098	3551	3896
9257-W 	Easy Access/Hip Chair Wood Arm Caps W 26 ¹ / ₂ D 29 ¹ / ₂ H 40 ³ / ₄ Seat Height 25 Inside Seat Width 21 Inside Seat Depth 19 ¹ / ₂ Arm Height 32 ¹ / ₄ 2 ¹ / ₄ yds. 48 lbs. COL 45 sq. ft.	1829	1976	2048	2093	2165	2243	2318	2392	2462	2545	2885	3143



OPTIONS		
-PFW02	Premium Wood Finish, Arm Caps	22
-CO01	Corian Arm Cap (per arm)	84
-MB01	Moisture Barrier (seat only)	69
-PFM02	Premium Metal Finish	111
-NS04	Non-Skid Glides	29

 = Available on quick-ship program (standard wood arm cap finishes and metallic silver frame finish only).

SOA GUEST + TANDEM // DESIGNED BY CLAUDIO BELLINI STUDIO

ORDERING REQUIREMENTS:

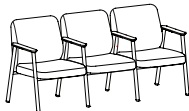
- » Model number
- » Arm cap selection and finish
- » Metal frame finish
- » Upholstery selection
- » Options, as applicable

MODEL NUMBER	PRODUCT SPECIFICATIONS	FABRIC GRADES										LEATHER	
		COM	A	1	2	COL					L1	L2	
9210-2-W 	Two-Seat Tandem Wood Arm Caps W 50 D 29 H 35 Seat Height 18 ¹ / ₂ Inside Seat Width 21 Inside Seat Depth 19 ¹ / ₂ Arm Height 25 ³ / ₄ 4 ¹ / ₄ yds. 80 lbs. COL 85 sq. ft.	2919	3196	3332	3417	3553	3701	3842	3982	4114	4271	4913	5401
9210-3-W 	Three-Seat Tandem Wood Arm Caps W 73 ³ / ₄ D 29 H 35 Seat Height 18 ¹ / ₂ Inside Seat Width 21 Inside Seat Depth 19 ¹ / ₂ Arm Height 25 ³ / ₄ 6 yds. 115 lbs. COL 120 sq. ft.	4306	4696	4888	5008	5200	5410	5608	5806	5992	6214	7120	7810
9210-4-W 	Four-Seat Tandem Wood Arm Caps W 97 ¹ / ₄ D 29 H 35 Seat Height 18 ¹ / ₂ Inside Seat Width 21 Inside Seat Depth 19 ¹ / ₂ Arm Height 25 ³ / ₄ 8 yds. 150 lbs. COL 160 sq. ft.	5695	6215	6471	6631	6887	7167	7431	7695	7943	8239	9447	10367

OPTIONS

-PFW01	Premium Wood Finish, Arm Cap (per arm)	12
-CO01	Corian Arm Cap (per arm)	84
-MB01	Moisture Barrier (seat only, per seat)	133
-PFM01	Premium Metal Finish (per arm frame)	78
-NS02	Non-Skid Glides (per arm frame)	15

SOA GUEST + TANDEM // DESIGNED BY CLAUDIO BELLINI STUDIO

ORDERING INSTRUCTIONS:

- » To build tandem configurations, always specify units from left-to-right as facing.
- » Starter units ('-ST') represent the first seating model in a configuration with subsequent modular units building onto them towards the right.
- » Add-On units ('-AO') can only be added next to Starter units.
- » End-units ('-EU') represent the final seating model in a configuration.
- » End tables can only start or end a configuration, therefore they will always come before a Starter unit or after an End unit (i.e. Add-On units cannot be specified next to connecting tables).
- » Inline and corner tables are for intermediate placement only (cannot start or end a configuration) and for specification purposes, will always come before a Starter and End unit (i.e. Add-On units cannot be specified next to connecting tables).
- » Refer to page 9 for connecting tables.
- » **Layout drawing or sketch must be provided with each order.**

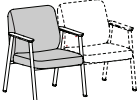
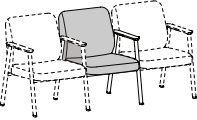
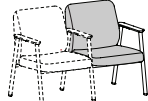
MODEL NUMBER	PRODUCT SPECIFICATIONS	FABRIC GRADES										LEATHER			
		COM	A	1	2	COL		3	4	5	6	7	8	L1	L2
9220-ST-W 	Tandem Starter Unit Wood Arm Caps W 26 ¹ / ₂ D 29 H 35 Seat Height 18 ¹ / ₂ Inside Seat Width 21 Inside Seat Depth 19 ¹ / ₂ Arm Height 25 ³ / ₄ 2 ¹ / ₄ yds. 45 lbs. COL 45 sq. ft.	1663	1810	1882	1927	1999	2077	2152	2226	2296	2379	2719	2977		
9220-AO-W 	Tandem Add-On Unit Wood Arm Caps W 24 ¹ / ₂ D 29 H 35 Seat Height 18 ¹ / ₂ Inside Seat Width 21 Inside Seat Depth 19 ¹ / ₂ Arm Height 25 ³ / ₄ 2 ¹ / ₄ yds. 35 ¹ / ₂ lbs. COL 45 sq. ft.	1564	1711	1783	1828	1900	1978	2053	2127	2197	2280	2620	2878		
9220-EU-W 	Tandem End Unit Wood Arm Caps W 24 ¹ / ₂ D 29 H 35 Seat Height 18 ¹ / ₂ Inside Seat Width 21 Inside Seat Depth 19 ¹ / ₂ Arm Height 25 ³ / ₄ 2 ¹ / ₄ yds. 35 ¹ / ₂ lbs. COL 45 sq. ft.	1564	1711	1783	1828	1900	1978	2053	2127	2197	2280	2620	2878		

OPTIONS		
-PFW01	Premium Wood Finish, Arm Cap (per arm)	12
-CO01	Corian Arm Cap (per arm)	84
-MB01	Moisture Barrier (seat only, per seat)	133
-PFM01	Premium Metal Finish (per arm frame)	78
-NS02	Non-Skid Glides (per arm frame)	15

SOA GUEST + TANDEM // DESIGNED BY CLAUDIO BELLINI STUDIO

ORDERING INSTRUCTIONS:

- » To build tandem configurations, always specify units from left-to-right as facing.
- » Starter units ('-ST') represent the first seating model in a configuration with subsequent modular units building onto them towards the right.
- » Add-On units ('-AO') can only be added next to Starter units.
- » End-units ('-EU') represent the final seating model in a configuration.
- » End tables can only start or end a configuration, therefore they will always come before a Starter unit or after an End unit (i.e. Add-On units cannot be specified next to connecting tables).
- » Inline and corner tables are for intermediate placement only (cannot start or end a configuration) and for specification purposes, will always come before a Starter and End unit (i.e. Add-On units cannot be specified next to connecting tables).
- » Refer to page 9 for connecting tables.
- » **Layout drawing or sketch must be provided with each order.**

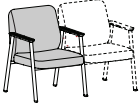
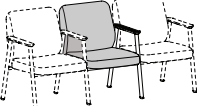
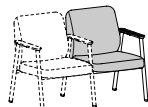



MODEL NUMBER	PRODUCT SPECIFICATIONS	FABRIC GRADES										LEATHER	
		COM	A	1	2	COL 3	4	5	6	7	8	L1	L2
9220-ST-U 	Tandem Starter Unit Black Urethane Arm Caps W 26 ¹ / ₂ D 29 H 35 Seat Height 18 ¹ / ₂ Inside Seat Width 21 Inside Seat Depth 19 ¹ / ₂ Arm Height 25 ³ / ₄ 2 ¹ / ₄ yds. 45 lbs. COL 45 sq. ft.	1544	1691	1763	1808	1880	1958	2033	2107	2177	2260	2600	2858
9220-AO-U 	Tandem Add-On Unit Black Urethane Arm Caps W 24 ¹ / ₂ D 29 H 35 Seat Height 18 ¹ / ₂ Inside Seat Width 21 Inside Seat Depth 19 ¹ / ₂ Arm Height 25 ³ / ₄ 2 ¹ / ₄ yds. 35 ¹ / ₂ lbs. COL 45 sq. ft.	1505	1652	1724	1769	1841	1919	1994	2068	2138	2221	2561	2819
9220-EU-U 	Tandem End Unit Black Urethane Arm Caps W 24 ¹ / ₂ D 29 H 35 Seat Height 18 ¹ / ₂ Inside Seat Width 21 Inside Seat Depth 19 ¹ / ₂ Arm Height 25 ³ / ₄ 2 ¹ / ₄ yds. 35 ¹ / ₂ lbs. COL 45 sq. ft.	1505	1652	1724	1769	1841	1919	1994	2068	2138	2221	2561	2819

OPTIONS		
-MB01	Moisture Barrier (seat only, per seat)	69
-PFM01	Premium Metal Finish (per arm frame)	78
-NS02	Non-Skid Glides (per arm frame)	15

SOA GUEST + TANDEM // DESIGNED BY CLAUDIO BELLINI STUDIO

ORDERING INSTRUCTIONS:

- » Connecting tables can only be specified as part of a modular configuration due to attachment requirements.
- » Models ordered separately.
- » Layout drawing or sketch must be provided with each order.

MODEL NUMBER	PRODUCT SPECIFICATIONS	VENEER OR LAMINATE	FENIX (-FE)	CORIAN (-CO)
9217-22 	Inline Connecting Table W 22 D 22 13 lbs.	914	1650	1499
9218-22L 	Left End Connecting Table (as facing) W 22 D 22 13 lbs.	1007	1743	1592
9218-22R 	Right End Connecting Table (as facing) W 22 D 22 13 lbs.	1007	1743	1592
9219-90 	Corner Connecting Table W 22 D 22 13 lbs.	1373	2109	1958
OPTIONS				
-PFW04	Premium Wood Finish	44		
-PFM01	Premium Metal Leg Finish	78		
-NS02	Non-Skid Glides	15		

SOA GUEST + TANDEM // DESIGNED BY CLAUDIO BELLINI STUDIO

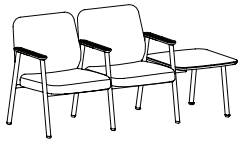

<u>Qty</u>	<u>Model #</u>	<u>Description</u>	<u>COM List</u>
1	9220-ST-U	Tandem Starter Unit, Urethane Arm Caps	\$1,544
1	9220-EU-U	Tandem End Unit, Urethane Arm Caps	\$1,505
1	9218-22R	Right End Connecting Table	\$1,007
			\$4,056

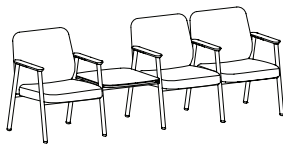

<u>Qty</u>	<u>Model #</u>	<u>Description</u>	<u>COM List</u>
1	9220-ST-W	Tandem Starter Unit, Wood Arm Caps	\$1,663
1	9217-22	Inline Connecting Table	\$914
1	9220-ST-W	Tandem Starter Unit, Wood Arm Caps	\$1,663
1	9220-EU-W	Tandem End Unit, Wood Arm Cap	\$1,564
			\$5,804

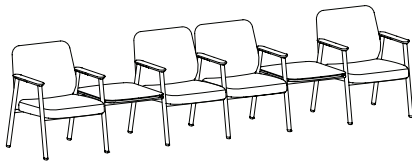

<u>Qty</u>	<u>Model #</u>	<u>Description</u>	<u>COM List</u>
1	9220-ST-W	Tandem Starter Unit, Wood Arm Caps	\$1,663
1	9217-22	Inline Connecting Table	\$914
1	9220-ST-W	Tandem Starter Unit, Wood Arm Caps	\$1,663
1	9220-EU-W	Tandem End Unit, Wood Arm Cap	\$1,564
1	9217-22	Inline Connecting Table	\$914
1	9220-ST-W	Tandem Starter Unit, Wood Arm Caps	\$1,663
			\$8,381

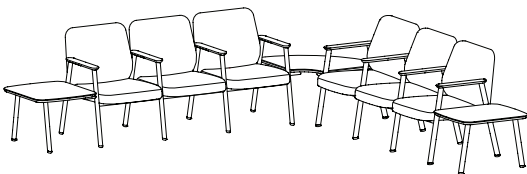





<u>Qty</u>	<u>Model #</u>	<u>Description</u>	<u>COM List</u>
1	9218-22L	Left End Connecting Table	\$1,007
1	9220-ST-W	Tandem Starter Unit, Wood Arm Caps	\$1,663
1	9220-AO-W	Tandem Add-On Unit, Wood Arm Cap	\$1,564
1	9220-EU-W	Tandem End Unit, Wood Arm Cap	\$1,564
1	9219-90-W	Corner Table	\$1,373
1	9220-ST-W	Tandem Starter Unit, Wood Arm Caps	\$1,663
1	9220-AO-W	Tandem Add-On Unit, Wood Arm Cap	\$1,564
1	9220-EU-W	Tandem End Unit, Wood Arm Cap	\$1,564
1	9218-22R	Right End Connecting Table	\$1,007
			\$12,969

SOA GUEST + TANDEM // DESIGNED BY CLAUDIO BELLINI STUDIO

RECLAIM PROGRAM:

To further extend the product life-cycle while contributing to sustainable outcomes, Arcadia offers a recycling program on upholstered seat and/or back cushions for when damages occur or as aesthetic changes dictate. To participate, please follow the guidelines below.

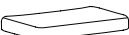



- » Submit a new purchase order for cushions needing replacement.
- » Standard lead-time is fifteen business days from receipt of fabric.
- » When new cushions are received and applicable cushions replaced, deposit old cushions inside the same shipping carton and contact Client Services to arrange pick-up. Return shipment costs will be covered by Arcadia.
- » All returned cushions will be disassembled for recycling and/or repurposed into other products.

MODEL NUMBER	PRODUCT SPECIFICATIONS	FABRIC GRADES										LEATHER	
		COM	A	1	2	COL 3	4	5	6	7	8	L1	L2
RS-9210 	Replacement Upholstered Seat, Guest and Tandem Models 1 yd. COL 20 sq. ft. Applies to: 9210 Guest + Preconfigured Tandem 9220 Modular Units	172	237	269	289	321	356	389	422	453	490	641	756
RS-9257 	Replacement Upholstered Seat, Easy Access/Hip Model 1 yd. COL 20 sq. ft.	172	237	269	289	321	356	389	422	453	490	641	756
RB-9210 	Replacement Upholstered Back, Guest, Tandem and Easy Access/Hip Models 1 yd. COL 20 sq. ft. Applies to: 9210 Guest + Preconfigured Tandem 9220 Modular Units 9257 Easy Access/Hip Chair	200	265	297	317	349	384	417	450	481	518	669	784
RS-9236 	36" Wide Bariatric Settee Replacement Upholstered Seat 1 yd. COL 20 sq. ft.	187	252	284	304	336	371	404	437	468	505	656	771
RB-9236 	36" Wide Bariatric Settee Replacement Upholstered Back 1 1/2 yds. COL 30 sq. ft.	221	319	367	397	445	497	547	596	643	698	925	1097
OPTIONS													
-MB01	Moisture Barrier (RS-9210 and RS9257 only)			69									
-MB02	Moisture Barrier (RS-9236 only)			133									

SOA GUEST + TANDEM // DESIGNED BY CLAUDIO BELLINI STUDIO

PRODUCT FEATURES:

- » Replacement hardware included with replacement frames.

MODEL NUMBER	PRODUCT SPECIFICATIONS	LIST
<p>9210-05R (RIGHT ARM, AS SEATED) 9210-05L (LEFT ARM, AS SEATED) 9210-05C (CENTER ARM)</p> 	<p>Replacement Arm Frame No Arm Cap 8 lbs.</p>	231
<p>9210-07W (WOOD)</p> 	<p>Replacement Wood Arm Cap 2 lbs.</p>	195
<p>9210-07UB (BLACK)</p> 	<p>Replacement Black Urethane Arm Cap 2 lbs.</p>	109
<p>9210-07C (CORIAN)</p> 	<p>Replacement Corian Arm Cap (standard colors only) 2 lbs.</p>	189

OPTIONS		
-PFW01	Premium Wood Finish, Wood Arm Cap	12
-PFM01	Premium Metal Finish (per arm frame)	78
-NS02	Non-Skid Glides	15

SOA GUEST + TANDEM // DESIGNED BY CLAUDIO BELLINI STUDIO

UPHOLSTERY COMBINATIONS:

- » For upholstery combinations, refer to the pricing below:
- » When combining two COM/COV/COL fabrics, or fabrics with the same grade, add \$120 per unit.
- » When combining three or more COM/COV/COL fabrics, or fabrics with the same grade, add \$150 per unit.
- » When combining different grades of fabric, price will be based on the highest grade specified.
- » Two-tone upholstery examples and yardage requirements for the most common combinations are listed below. Additional combinations available, please contact Client Services yardage requirements and pricing.
- » Note: Yardage amounts are based on fabric which is plain (i.e. non-directional) and a full 54" wide.
- » Appropriate upholstery code must be included.



Code	S01
<u>Models</u>	<u>COM Requirement</u>
All Guest	Seat = 1 yd.
& Easy	Back = 1 ¹ / ₄ yds.
Access Units	



Code	S02
<u>Models</u>	<u>COM Requirement</u>
36" W	Seat = 1 ¹ / ₂ yds.
Bariatric	Back = 2 yds.
Settee	

SOLEIL GUEST SEATING



arcadia

MARCH 1, 2026
VA IDIQ CONTRACT (FY26)
(DEALER HELD)

SOLEIL GUEST + TANDEM // DESIGNED BY DAVID DAHL



PRODUCT FEATURES:



- Arm cap features radiused edges for smooth surface contact.
- All styles field-replaceable.



- Passive flex back motion provides long-term seated comfort.



- Clean-outs on every side, including between the seat and back.
- Enables crumbs and debris to fall through for maintenance ease.



- Metal seat frame construction ensures durability and allows in-field component replacement.

SOLEIL GUEST + TANDEM // DESIGNED BY DAVID DAHL

PRODUCT FEATURES CONTINUED:

- » Wall-saver leg design.
- » Optional replaceable seat upholstery available on all units.
- » Replacement seat covers can be easily field-installed on previously ordered Soleil models with standard fixed upholstery. Contact client services for instructions.
- » All dimensions are nominal.

TANDEM + MODULAR FEATURES:

- » To build tandem configurations, always specify units from left-to-right, as facing.
- » Available in two and three-seat combinations or as reconfigurable modular units.
- » Seats, together with backs, are specified individually, as are arm frame units.
- » Inline, corner and end tables available for reconfigurable modular units only, with beech veneer, laminate or Corian tops.
- » Veneer and laminate tables are 3³/₄" wide at its thickest point in back, and narrows to 1¹/₄" wide in front.
- » Corian top is affixed to table surface increasing overall table height by 1/2".
- » **Note: Please include layout drawings or sketch with each order.**
- » Arcadia will pre-assemble units at the factory to maximize shipping allowances and minimize field assembly.

SPECIFICATIONS:

- » Arm caps available in wood, black urethane, grey urethane and Corian.
- » Wood arm caps standard in beech, in all standard and custom finishes.
- » Walnut and white oak wood arm cap options also offered. Please specify 'WC03' next to model number and add applicable upcharge.
- » Premium wood finish upcharge applies to the following wood finishes. Refer to options section for pricing.
 - Super Matte Sable Beech
 - Alabaster Oak
 - Super Matte Sable Oak
- » For custom wood finishes, please add one-time upcharge of \$514 List per color per order.
- » Corian arm caps and tables available in four standard colors. For non-standard colors, please contact client services for pricing.
- » For Corian arm caps, a wood species and finish must be specified for the arm cap lower portion.
- » Tables available in beech veneer as well as laminate and Corian.
- » For custom laminates, add \$642 List per color per order. Pre-approval required, please contact client services.
- » Veneer and laminate tables feature matching edges as standard.
- » **Table with Corian top, wood edge finish selection must be specified.**
- » Metal frame available in standard and premium finishes.

STANDARD METAL FRAME FINISHES:

- » 0405 Charcoal Grey
- » 0535 Metallic Silver

PREMIUM METAL FRAME FINISHES:

- » 0605 Matte Black
- » 0705 Matte Cotton
- » 0788 Glossy Cotton
- » 0805 Oasis
- » 0905 Mint
- » 1005 Mercury
- » 1105 Canary
- » 1205 Stone
- » 1305 Sage
- » 1405 Ice Blue
- » 1505 Clay

CORIAN® COLORS:

- » CWN Designer White
- » CLN Linen
- » CTD Witch Hazel
- » CRC Rain Cloud
- » CGQ Grey Onyx
- » CSQ Stonique

WEIGHT CAPACITY:

- » Guest Chair 350 lbs.
- » Preconfigured Tandem 350 lbs. per seat
- » Reconfigurable Tandem 350 lbs. per seat
- » Bariatric Chairs 750 lbs.
- » Patient Chair 350 lbs.
- » Easy Access/Hip Chair 350 lbs.



ORDERING REQUIREMENTS:

- » Model number
- » Upper arm cap finish
- » Lower arm cap finish, as applicable
- » Metal frame finish
- » Upholstery selection
- » Options, as applicable

SOLEIL GUEST + TANDEM // DESIGNED BY DAVID DAHL

ORDERING REQUIREMENTS:

- » Model number
- » Upper arm cap finish
- » Lower arm cap finish, as applicable
- » Metal frame finish
- » Upholstery selection
- » Options, as applicable

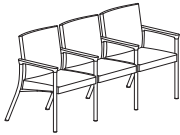
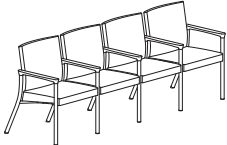
MODEL NUMBER	PRODUCT SPECIFICATIONS	ARM CAPS	FABRIC GRADES										LEATHER	
			COM	A	1	2	COL		3	4	5	6	7	8
4410-W (BEECH) 4410-UB (BLACK URETHANE) 4410-UG (GREY URETHANE) 4410-CO (CORIAN)	Single Guest Chair W 24 ¹ / ₂ D 26 ¹ / ₂ H 34 Seat Height 18 Inside Seat Width 20 ¹ / ₂ Inside Seat Depth 18 Arm Height 24 ³ / ₄ 1 ¹ / ₂ yds. 29 lbs.	Beech*	1595	1693	1741	1771	1819	1871	1921	1970	2017	2072	2299	2471
		Urethane	1595	1693	1741	1771	1819	1871	1921	1970	2017	2072	2299	2471
		Corian	2005	2103	2151	2181	2229	2281	2331	2380	2427	2482	2709	2881
														
4410-2-W (BEECH) 4410-2-UB (BLACK URETHANE) 4410-2-UG (GREY URETHANE) 4410-2-CO (CORIAN)	Two-Seat Tandem W 46 ¹ / ₂ D 26 ¹ / ₂ H 34 Seat Height 18 Inside Seat Width 20 ¹ / ₂ Inside Seat Depth 18 Arm Height 24 ³ / ₄ 3 yds. 58 lbs.	Beech*	2905	3100	3196	3256	3352	3457	3556	3655	3748	3859	4312	4657
		Urethane	2905	3100	3196	3256	3352	3457	3556	3655	3748	3859	4312	4657
		Corian	3520	3715	3811	3871	3967	4072	4171	4270	4363	4474	4927	5272
														
4410-3-W (BEECH) 4410-3-UB (BLACK URETHANE) 4410-3-UG (GREY URETHANE) 4410-3-CO (CORIAN)	Three-Seat Tandem W 69 D 26 ¹ / ₂ H 34 Seat Height 18 Inside Seat Width 20 ¹ / ₂ Inside Seat Depth 18 Arm Height 24 ³ / ₄ 4 ¹ / ₂ yds. 87 lbs.	Beech*	4215	4508	4652	4742	4886	5043	5192	5340	5480	5646	6326	6843
		Urethane	4215	4508	4652	4742	4886	5043	5192	5340	5480	5646	6326	6843
		Corian	5035	5328	5472	5562	5706	5863	6012	6160	6300	6466	7146	7663
														
4410-4-W (BEECH) 4410-4-UB (BLACK URETHANE) 4410-4-UG (GREY URETHANE) 4410-4-CO (CORIAN)	Four-Seat Tandem W 91 ¹ / ₂ D 26 ¹ / ₂ H 34 Seat Height 18 Inside Seat Width 20 ¹ / ₂ Inside Seat Depth 18 Arm Height 24 ³ / ₄ 6 yds. 116 lbs.	Beech*	5523	5913	6105	6225	6417	6627	6825	7023	7209	7431	8337	9027
		Urethane	5523	5913	6105	6225	6417	6627	6825	7023	7209	7431	8337	9027
		Corian	6548	6938	7130	7250	7442	7652	7850	8048	8234	8456	9362	10052
														

OPTIONS

-MB01	Moisture Barrier (seat only, per seat)	69
-SC01	Replaceable Seat Cover Feature (per seat)	64
-WC03	Walnut/White Oak Wood Arm Cap (per arm)	129
-NS02	Non-Skid Glides (per arm frame)	15
-PFM01	Premium Metal Finish (per arm frame)	78
-PFW01	Premium Wood Finish, Arm Cap (per arm)	12

*For walnut or white oak wood arm cap options, please specify finish and add applicable upcharge.

SOLEIL GUEST + TANDEM // DESIGNED BY DAVID DAHL

ORDERING REQUIREMENTS:

- » Model number
- » Upper arm cap finish
- » Lower arm cap finish, as applicable
- » Metal frame finish
- » Upholstery selection
- » Options, as applicable

MODEL NUMBER	PRODUCT SPECIFICATIONS	ARM CAPS	FABRIC GRADES										LEATHER	
			COM	A	1	2	COL		3	4	5	6	7	8
4440-W (BEECH) 4440-UB (BLACK URETHANE) 4440-UG (GREY URETHANE) 4440-CO (CORIAN)	Bariatric Settee, 34" Wide W 34 D 26 ¹ / ₂ H 34 Seat Height 18 Inside Seat Width 30 Inside Seat Depth 18 Arm Height 24 ³ / ₄ 2 ¹ / ₂ yds. 40 lbs.	Beech*	2054	2217	2297	2347	2427	2514	2597	2679	2757	2849	3227	3514
		Urethane	2054	2217	2297	2347	2427	2514	2597	2679	2757	2849	3227	3514
		Corian	2464	2627	2707	2757	2837	2924	3007	3089	3167	3259	3637	3924
4445-W (BEECH) 4445-UB (BLACK URETHANE) 4445-UG (GREY URETHANE) 4445-CO (CORIAN)	Bariatric Settee, 40" Wide W 40 D 26 ¹ / ₂ H 34 Seat Height 18 Inside Seat Width 36 Inside Seat Depth 18 Arm Height 24 ³ / ₄ 2 ³ / ₄ yds. 44 lbs.	Beech*	2337	2516	2604	2659	2747	2843	2934	3025	3110	3212	3627	3943
		Urethane	2337	2516	2604	2659	2747	2843	2934	3025	3110	3212	3627	3943
		Corian	2747	2926	3014	3069	3157	3253	3344	3435	3520	3622	4037	4353

OPTIONS

-MB02	Moisture Barrier (seat only)	133
-SC02	Replaceable Seat Cover Feature	84
-WC03	Walnut/White Oak Wood Arm Cap (per arm)	129
-NS04	Non-Skid Glides	29
-PFM02	Premium Metal Finish	111
-PFW01	Premium Wood Finish, Arm Cap (per arm)	12

*For walnut or white oak wood arm cap options, please specify finish and add applicable upcharge.

SOLEIL GUEST + TANDEM // DESIGNED BY DAVID DAHL

ORDERING REQUIREMENTS:

- » Model number
- » Upper arm cap finish
- » Lower arm cap finish, as applicable
- » Metal frame finish
- » Upholstery selection
- » Options, as applicable

MODEL NUMBER	PRODUCT SPECIFICATIONS	ARM CAPS	COM	A	1	2	FABRIC GRADES						LEATHER	
							COL 3	4	5	6	7	8	L1	L2
4450-W (BEECH) 4450-UB (BLACK URETHANE) 4450-UG (GREY URETHANE) 4450-CO (CORIAN)	Patient Chair W 24 ¹ / ₂ D 26 ¹ / ₂ H 42 ¹ / ₂ Seat Height 18 Inside Seat Width 20 ¹ / ₂ Inside Seat Depth 18 Arm Height 24 ³ / ₄ 1 ³ / ₄ yds. 31 lbs.	Beech*	1663	1777	1833	1868	1924	1985	2043	2101	2155	2220	2484	2685
		Urethane	1663	1777	1833	1868	1924	1985	2043	2101	2155	2220	2484	2685
		Corian	2073	2187	2243	2278	2334	2395	2453	2511	2565	2630	2894	3095
4457-W (BEECH) 4457-UB (BLACK URETHANE) 4457-UG (GREY URETHANE) 4457-CO (CORIAN)	Easy Access/Hip Chair W 24 ¹ / ₂ D 26 ¹ / ₂ H 41 ¹ / ₂ Seat Height 25 Inside Seat Width 20 ¹ / ₂ Inside Seat Depth 18 Arm Height 32 ¹ / ₄ 1 ¹ / ₂ yds. 42 lbs.	Beech*	2012	2110	2158	2188	2236	2288	2338	2387	2434	2489	2716	2888
		Urethane	2012	2110	2158	2188	2236	2288	2338	2387	2434	2489	2716	2888
		Corian	2422	2520	2568	2598	2646	2698	2748	2797	2844	2899	3126	3298



OPTIONS

-MB01	Moisture Barrier (seat only)	69
-SC01	Replaceable Seat Cover Feature	64
-WC03	Walnut/White Oak Wood Arm Cap (per arm)	129
-NS04	Non-Skid Glides	29
-PFM02	Premium Metal Finish	111
-PFW01	Premium Wood Finish, Arm Cap (per arm)	12

*For walnut or white oak wood arm cap options, please specify finish and add applicable upcharge.

SOLEIL GUEST + TANDEM // DESIGNED BY DAVID DAHL

ORDERING REQUIREMENTS:

- » Model number
- » Upholstery selection
- » Options, as applicable

Note: For tandem configurations only.

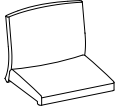
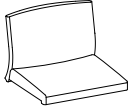
MODEL NUMBER	PRODUCT SPECIFICATIONS	FABRIC GRADES										LEATHER	
		COM	A	1	2	COL 3	4	5	6	7	8	L1	L2
4420	20¹/₂" Wide Seat & Back 1 ¹ / ₂ yds. 16 lbs.	985	1083	1131	1161	1209	1261	1311	1360	1407	1462	1689	1861
													
4430	30" Wide Seat & Back 2 ¹ / ₂ yds. 23 lbs.	1351	1514	1594	1644	1724	1811	1894	1976	2054	2146	2524	2811
													
4436	36" Wide Seat & Back 2 ³ / ₄ yds. 26 lbs.	1619	1798	1886	1941	2029	2125	2216	2307	2392	2494	2909	3225
													
	Arm Frames Page 7 Connecting Tables Page 8												



OPTIONS		
-MB01	Moisture Barrier, 20 ¹ / ₂ " Wide (seat only)	69
-MB02	Moisture Barrier, 30" and 36" Wide (seat only)	133
-SC01	Replaceable Seat Cover Feature, 20 ¹ / ₂ " Wide	64
-SC02	Replaceable Seat Cover Feature, 30" and 36" Wide	84

SOLEIL GUEST + TANDEM // DESIGNED BY DAVID DAHL

ORDERING REQUIREMENTS:

- » Model number
- » Upper arm cap finish
- » Lower arm cap finish, as applicable
- » Metal frame finish
- » Options, as applicable

Note: For tandem configurations only.

MODEL NUMBER	PRODUCT SPECIFICATIONS	ARM CAP	LIST
4400-R-W (BEECH) 4400-R-UB (BLACK URETHANE) 4400-R-UG (GREY URETHAN) 4400-R-CO (CORIAN)	Metal Arm Frame with Arm Cap Right (as facing) 7 lbs.	Beech*	311
		Urethane	311
		Corian	516
			
4400-L-W (BEECH) 4400-L-UB (BLACK URETHANE) 4400-L-UG (GREY URETHANE) 4400-L-CO (CORIAN)	Metal Arm Frame with Arm Cap Left (as facing) 7 lbs.	Beech*	311
		Urethane	311
		Corian	516
			
4400-C-W (BEECH) 4400-C-UB (BLACK URETHANE) 4400-C-UG (GREY URETHANE) 4400-C-CO (CORIAN)	Metal Arm Frame with Arm Cap, Center 8 lbs.	Beech*	336
		Urethane	336
		Corian	541
			
Seats & Backs Models Page 6 Connecting Tables Page 8			

OPTIONS		
-WC03	Walnut/White Oak Wood Arm Cap (per arm)	129
-NS01	Non-Skid Glides (per arm)	10
-PFM01	Premium Metal Finish (per arm frame)	78
-PFW01	Premium Wood Finish, Arm Cap (per arm)	12

*For walnut or white oak wood arm cap options, please specify finish and add applicable upcharge.

SOLEIL GUEST + TANDEM // DESIGNED BY DAVID DAHL

ORDERING REQUIREMENTS:

- » Model number
- » Wood species
- » Wood finish
- » Metal leg finish, as applicable
- » Options, as applicable

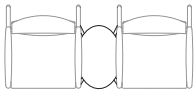
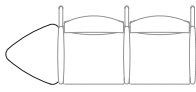
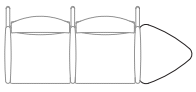
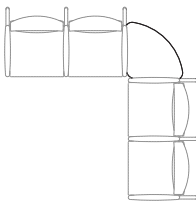





MODEL NUMBER	PRODUCT SPECIFICATIONS	TABLE TOP FINISH	
		VENEER OR LAMINATE	CORIAN (-CO)
4417 	Center Table Inline Add-On W 14 D 20 13 lbs. Field Installed	809	1313
4418-L 	End Table, Left (as facing) W 19 D 20 ^{1/2} 9 lbs. Field Installed	968	1777
4418-R 	End Table, Right (as facing) W 19 D 20 ^{1/2} 9 lbs. Field Installed	968	1777
4419-90 	90-Degree Corner Table W 22 ^{1/2} D 22 ^{1/2} 12 lbs. Field Installed	1041	2347

OPTIONS		
-NS01	Non-Skid Glides	10
-PFM01	Premium Metal Finish (per leg)	78
-PFW01	Premium Wood Finish	12

SOLEIL GUEST + TANDEM // DESIGNED BY DAVID DAHL

ORDERING REQUIREMENTS:

- » Model number
- » Upholstery selection, as applicable
- » Arm cap finish, as applicable

MODEL NUMBER	PRODUCT SPECIFICATIONS	FABRIC GRADES										LEATHER			
		COM	A	1	2	COL		3	4	5	6	7	8	L1	L2
SSC-4410 	Replacement Upholstered Seat Cover Only 3/4 yd.	166	215	239	254	278	304	329	354	377	405	518	604		
	Applies to: 4410 Guest 4420 Tandem 4450 Patient Chair 4457 Easy Access/Hip Chair														
SSC-4440 	34" Wide Bariatric Settee Replacement Upholstered Seat Cover Only 1 yd.	257	322	354	374	406	441	474	507	538	575	726	841		
SSC-4445 	40" Wide Bariatric Settee Replacement Upholstered Seat Cover Only 1 1/4 yds.	257	339	379	404	444	487	529	570	609	655	844	987		
44-W (WOOD) 	Replacement Arm Cap, Wood 2 lbs.	166													
44-UB (BLACK URETHANE) 44-UG (GREY URETHANE) 	Replacement Arm Cap Black or Grey Urethane 2 lbs.	166													
44-CO (CORIAN) 	Replacement Arm Cap, Corian (standard colors only) 2 lbs.	285													





OPTIONS

-PFW01	Premium Wood Finish, Arm Cap (per arm)	12
--------	--	----

SOLEIL GUEST + TANDEM // DESIGNED BY DAVID DAHL

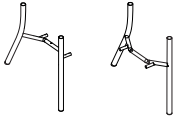
ORDERING REQUIREMENTS:

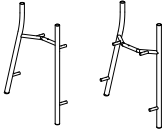

- » Model number
- » Metal frame/leg finish, as applicable
- » Options, as applicable

MODEL NUMBER		LIST
<p>SA-4410-R (RIGHT ARM, AS SEATED) SA-4410-L (LEFT ARM, AS SEATED)</p> 	<p>Replacement Guest Chair Arm Frame (Arm Cap Not Included) 5 lbs.</p>	284
<p>SA-4410-C (CENTER ARM)</p> 	<p>Replacement Guest Chair Arm Frame (Arm Cap Not Included) 6 lbs.</p>	309
<p>SA-4457-R (RIGHT ARM, AS SEATED) SA-4457-L (LEFT ARM, AS SEATED)</p> 	<p>Replacement Easy Access/Hip Chair Arm Frame (Arm Cap Not Included) 6.5 lbs.</p>	302
<p>SA-4457-FR</p> 	<p>Replacement Easy Access/Hip Chair Foot Rest 7 lbs.</p>	333
<p>SL-4418-R SL-4418-L</p> 	<p>Replacement End Table Leg, Right (as seated) Replacement End Table Leg, Left (as seated) 5 lbs.</p>	284
OPTIONS		
-NS01	Non-Skid Glides	10
-PFM01	Premium Metal Finish (per leg)	78

SOLEIL GUEST + TANDEM // DESIGNED BY DAVID DAHL

ORDERING REQUIREMENTS:

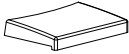
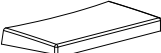
- » Model number
- » Upholstery selection



MODEL NUMBER	PRODUCT SPECIFICATIONS	FABRIC GRADES										LEATHER	
		COM	A	1	2	COL		3	4	5	6	7	8
SST-4410 	Replacement Seat Frame, Foam & Upholstery Cover 3/4 yd. 7 lbs.	414	463	487	502	526	552	577	602	625	653	766	852
	Applies to: 4410 Guest 4420 Tandem 4450 Patient Chair 4457 Easy Access/Hip Chair												
SST-4440 	34" Wide Bariatric Settee, Replacement Seat Frame, Foam & Upholstery Cover 1 1/2 yds. 10 lbs.	685	750	782	802	834	869	902	935	966	1003	1154	1269
SST-4445 	40" Wide Bariatric Settee, Replacement Seat Frame, Foam & Upholstery Cover 1 1/2 yds. 12 lbs.	837	919	959	984	1024	1067	1109	1150	1189	1235	1424	1567

OPTIONS		
-MB01	Moisture Barrier, 20 1/2" Wide (seat only)	69
-MB02	Moisture Barrier, 30" and 36" Wide (seat only)	133
-SC01	Replaceable Seat Cover Feature for SST-4410	64
-SC02	Replaceable Seat Cover Feature for SST-4440/SST-4445	84

SOLEIL GUEST + TANDEM // DESIGNED BY DAVID DAHL

ORDERING REQUIREMENTS:

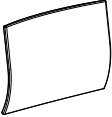
- » Model number
- » Upholstery selection

MODEL NUMBER	PRODUCT SPECIFICATIONS	FABRIC GRADES										LEATHER	
		COM	A	1	2	COL		3	4	5	6	7	8
SBK-4410 	Replacement Back Frame, Foam & Upholstery Cover 3/4 yd. 9 lbs.	448	497	521	536	560	586	611	636	659	687	800	886
SBK-4440 	34" Wide Bariatric Settee, Replacement Back Frame, Foam & Upholstery Cover 1 1/2 yds. 13 lbs.	723	821	869	899	947	999	1049	1098	1145	1200	1427	1599
SBK-4445 	40" Wide Bariatric Settee, Replacement Back Frame, Foam & Upholstery Cover 1 1/2 yds. 18 lbs.	871	969	1017	1047	1095	1147	1197	1246	1293	1348	1575	1747
SBK-4450 	Patient Chair, Replacement Back Frame, Foam & Upholstery Cover 1 yd. 9 lbs.	684	749	781	801	833	868	901	934	965	1002	1153	1268

SOLEIL GUEST + TANDEM // DESIGNED BY DAVID DAHL

CONFIGURATION EXAMPLES:

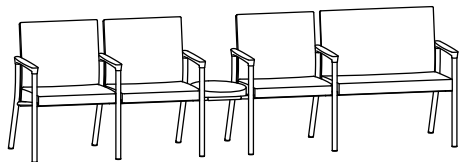

Qty	Model #	Description	COM List
3	4420	20 ¹ / ₂ " Wide Seat & Back (\$985 each)	\$2,955
1	4430	30" Wide Seat & Back	\$1,351
1	4400-L-W	Metal Arm, Left (as facing), Beech Arm Cap	\$311
1	4400-R-W	Metal Arm, Right (as facing), Beech Arm Cap	\$311
4	4400-C-W	Metal Arm, Center, Beech Arm Cap (\$336 each)	\$1,344
1	4417	Center Table	\$809
11			\$7,081

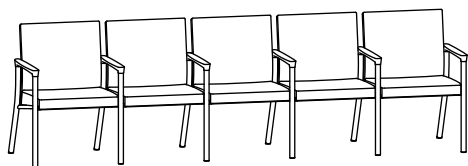

Qty	Model #	Description	COM List
5	4420	20 ¹ / ₂ " Wide Seat & Back (\$985 each)	\$4,925
1	4400-L-W	Metal Arm, Left (as facing), Beech Arm Cap	\$311
1	4400-R-W	Metal Arm, Right (as facing), Beech Arm Cap	\$311
4	4400-C-W	Metal Arm, Center, Beech Arm Cap (\$336 each)	\$1,344
11			\$6,891

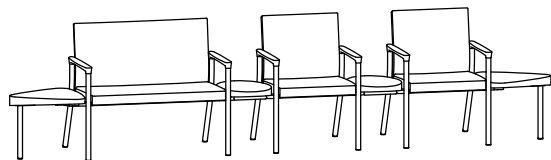

Qty	Model #	Description	COM List
1	4436	36" Wide Seat & Back	\$1,619
2	4420	20 ¹ / ₂ " Wide Seat & Back (\$985 each)	\$1,970
6	4400-C-CO	Metal Arm, Center, Corian Arm Cap (\$541 each)	\$3,246
1	4418-L-CO	End Table, Left, Corian Top	\$1,777
2	4417-CO	Center Table, Corian Top (\$1,313 each)	\$2,626
1	4418-R-CO	End Table, Right, Corian Top	\$1,777
13			\$13,015

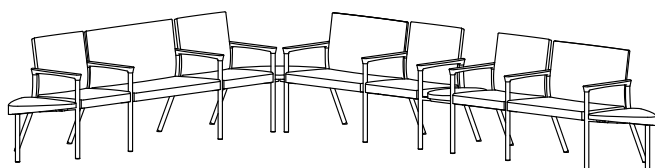

Qty	Model #	Description	COM List
4	4420	20 ¹ / ₂ " Wide Seat & Back (\$985 each)	\$3,940
2	4430	30" Wide Seat & Back (\$1,351 each)	\$2,702
1	4436	36" Wide Seat & Back	\$1,619
10	4400-C-U	Metal Arm, Center, Black Urethane Arm Cap (\$336 each)	\$3,360
1	4418-L	End Table, Left, Wood Top	\$968
1	4419-90	90-Degree Table, Wood Top	\$1,041
1	4417	Center Table, Wood Top	\$809
1	4418-R	End Table, Right, Wood Top	\$968
21			\$15,407

SOLEIL GUEST + TANDEM // DESIGNED BY DAVID DAHL

UPHOLSTERY COMBINATIONS:

- » When combining two COM/COV/COL fabrics, or fabrics with the same grade, add \$120 List per unit.
- » When combining three COM/COV/COL fabrics, or fabrics with the same grade, add \$150 List per unit.
- » When combining different grades of fabric, price will be based on the highest grade specified.
- » Two-tone upholstery examples and yardage requirements for the most common combinations are listed below. Additional combinations available, please contact client services for yardage requirements and pricing.
- » Note: Yardage amounts are based on fabric which is plain (i.e. non-directional) and a full 54" wide.
- » Appropriate upholstery code must be included.



Code	SH1
<u>Models</u>	<u>COM Requirement</u>
All Guest & Easy Access/Hip Chair Units	Seat = $\frac{3}{4}$ yd. Back = $\frac{3}{4}$ yd.

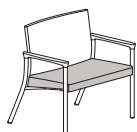

Code	SH2
<u>Models</u>	<u>COM Requirement</u>
All 34" W Bariatric Units	Seat = 1 yd. Back = $1\frac{1}{2}$ yds.

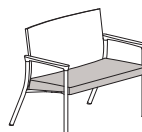

Code	SH3
<u>Models</u>	<u>COM Requirement</u>
All 40" W Bariatric Units	Seat = 1 yd. Back = $1\frac{1}{2}$ yds.



Code	SH4
<u>Models</u>	<u>COM Requirement</u>
4450	Seat = $\frac{3}{4}$ yd. Back = 1 yd.

SOLEIL LOUNGE SEATING



arcadia

MARCH 1, 2026
VA IDIQ CONTRACT (FY26)
(DEALER HELD)

SOLEIL LOUNGE // DESIGNED BY DAVID DAHL



PRODUCT FEATURES:



- Arm cap features radiused edges for smooth surface contact.
- All styles field-replaceable.



- Passive flex back motion provides long-term seated comfort.



- Clean-outs on every side, including between the seat and back.
- Enables crumbs and debris to fall through for maintenance ease.



- Metal seat frame construction ensures durability and allows in-field component replacement.

SOLEIL LOUNGE // DESIGNED BY DAVID DAHL

PRODUCT FEATURES CONTINUED:

- » **Wall-saver leg design.**
- » **Optional replaceable seat upholstery.**
- » **Replacement seat covers can be easily field installed on previously ordered Soleil models with standard fixed upholstery. Contact client services for instructions.**

SPECIFICATIONS:

- » **Metal frame available in standard and premium finishes.**
- » **Arm caps available in wood, black urethane, grey urethane and Corian.**
- » **Wood arm caps available in beech, as standard.**
- » **Walnut and white oak wood arm cap options also offered. Please specify 'WC03' next to model number and add applicable upcharge.**
- » **All standard and custom wood finishes available.**
- » **Premium wood finish upcharge applies to the following wood finishes. Refer to options section for pricing.**
 - **Super Matte Sable Beech**
 - **Alabaster Oak**
 - **Super Matte Sable Oak**
- » **For custom wood finishes, please add one-time upcharge of \$514 List per color per order.**
- » **For Corian arm caps, a wood species and finish must be specified for the arm cap lower portion.**
- » **Maximum weight capacity is 350 lbs.**
- » **All dimensions are nominal.**

STANDARD METAL FRAME FINISHES:

- » **0405 Charcoal Grey**
- » **0535 Metallic Silver**

PREMIUM METAL FRAME FINISHES:

- » **0605 Matte Black**
- » **0705 Matte Cotton**
- » **0788 Glossy Cotton**
- » **0805 Oasis**
- » **0905 Mint**
- » **1005 Mercury**
- » **1105 Canary**
- » **1205 Stone**
- » **1305 Sage**
- » **1405 Ice Blue**
- » **1505 Clay**

CORIAN® COLORS:

- » **CWN Designer White**
- » **CLN Linen**
- » **CTD Witch Hazel**
- » **CRC Rain Cloud**
- » **CGQ Grey Onyx**
- » **CSQ Stonique**



ORDERING REQUIREMENTS:

- » **Model number**
- » **Upper arm cap finish**
- » **Lower arm cap finish, as applicable**
- » **Metal frame finish**
- » **Upholstery selection**
- » **Options, as applicable**

SOLEIL LOUNGE // DESIGNED BY DAVID DAHL

ORDERING REQUIREMENTS:

- » Model number
- » Upper arm cap finish
- » Lower arm cap finish, as applicable
- » Metal frame finish
- » Upholstery selection
- » Options, as applicable

MODEL NUMBER	PRODUCT SPECIFICATIONS	FABRIC GRADES										LEATHER	
		COM	A	1	2	COL		3	4	5	6	7	8
4461-W 	Lounge Chair, Beech* Arm Caps W 26 ¹ / ₂ D 26 H 32 ¹ / ₂ Seat Height 17 ¹ / ₂ Inside Seat Width 22 ¹ / ₂ Inside Seat Depth 18 ¹ / ₂ Arm Height 24 1 ¹ / ₂ yds. 35 lbs.	2252	2350	2398	2428	2476	2528	2578	2627	2674	2729	2956	3128
4461-UB (BLACK) 4461-UG (GREY) 	Lounge Chair, Urethane Arm Caps W 26 ¹ / ₂ D 26 H 32 ¹ / ₂ Seat Height 17 ¹ / ₂ Inside Seat Width 22 ¹ / ₂ Inside Seat Depth 18 ¹ / ₂ Arm Height 24 1 ¹ / ₂ yds. 35 lbs.	2252	2350	2398	2428	2476	2528	2578	2627	2674	2729	2956	3128
4461-CO 	Lounge Chair, Corian Arm Caps W 26 ¹ / ₂ D 26 H 32 ¹ / ₂ Seat Height 17 ¹ / ₂ Inside Seat Width 22 ¹ / ₂ Inside Seat Depth 18 ¹ / ₂ Arm Height 24 1 ¹ / ₂ yds. 35 lbs.	2662	2760	2808	2838	2886	2938	2988	3037	3084	3139	3366	3538

OPTIONS



-WC03	Walnut/White Oak Wood Arm Cap (per arm)	129
-MB02	Moisture Barrier, Seat Only	133
-SC02	Replaceable Seat Cover Feature	84
-NS04	Non-Skid Glides	29
-PFM02	Premium Metal Finish	111
-PFW01	Premium Wood Finish, Arm cap (per arm)	12

*For walnut or white oak wood arm cap options, please specify finish and add applicable upcharge.

SOLEIL LOUNGE // DESIGNED BY DAVID DAHL

ORDERING REQUIREMENTS:

- » Model number
- » Upholstery selection, as applicable
- » Metal frame finish, as applicable
- » Arm cap finish, as applicable
- » Options, as applicable

MODEL NUMBER	PRODUCT SPECIFICATIONS	FABRIC GRADES										LEATHER	
		COM	A	1	2	COL		3	4	5	6	7	8
SSC-4461 	Lounge Chair Replacement Upholstered Seat Cover Only 3/4 yd.	260	309	333	348	372	398	423	448	471	499	612	698
SST-4461 	Lounge Chair Replacement Seat Frame, Foam and Upholstery Cover 3/4 yd. 9 lbs.	674	723	747	762	786	812	837	862	885	913	1026	1112
SBK-4461 	Lounge Chair Replacement Back Frame, Foam and Upholstery Cover 3/4 yd. 11 lbs.	813	862	886	901	925	951	976	1001	1024	1052	1165	1251

MODEL NUMBER		LIST
SA-4461-R (RIGHT ARM, AS SEATED) SA-4461-L (LEFT ARM, AS SEATED) 	Replacement Lounge Chair Arm Frame, No Arm Cap 9 lbs.	284
44-W (BEECH) 	Replacement Lounge Arm Cap, Beech Wood 2 lbs.	166
44-UB (BLACK URETHANE) 44-UG (GREY URETHANE) 	Replacement Lounge Arm Cap, Black or Grey Urethane 2 lbs.	166
44-CO (CORIAN) 	Replacement Lounge Arm Cap, Corian (standard colors only) 2 lbs.	285

OPTIONS		
-WC03	Walnut/White Oak Wood Arm Cap (per arm)	129
-MB02	Moisture Barrier, Seat Only	133
-SC02	Replaceable Seat Cover Feature	84
-NS04	Non-Skid Glides	29
-PFM02	Premium Metal Finish	111
-PFW01	Premium Wood Finish, Arm cap (per arm)	12

*For walnut or white oak wood arm cap options, please specify finish and add applicable upcharge.

SOLEIL LOUNGE // DESIGNED BY DAVID DAHL

UPHOLSTERY COMBINATIONS:

- » When combining two COM/COV/COL fabrics, or fabrics with the same grade, add \$120 List per unit.
- » When combining three COM/COV/COL fabrics, or fabrics with the same grade, add \$150 List per unit.
- » When combining different grades of fabric, price will be based on the highest grade specified.
- » Two-tone upholstery examples and yardage requirements for the most common combinations are listed below. Additional combinations available, please contact client services for yardage requirements and pricing.
- » Note: Yardage amounts are based on fabric which is plain (i.e. non-directional) and a full 54" wide.
- » Appropriate upholstery code must be included.



Code	SH15
<u>Models</u>	<u>COM Requirement</u>
4461	Seat = $\frac{3}{4}$ yd. Back = $\frac{3}{4}$ yd.

SOLEIL TABLES



arcadia

MARCH 1, 2026
VA IDIQ CONTRACT (FY26)
(DEALER HELD)

SOLEIL OCCASIONAL TABLES // DESIGNED BY DAVID DAHL



PRODUCT FEATURES/SPECIFICATIONS:

- » Tables manufactured in beech, walnut and white oak.
- » Three standard material finish options:
 - Beech, walnut or white oak veneer top tier with matching veneer body as standard, unless otherwise specified.
 - Laminate top tier with laminate body as standard, unless otherwise specified.
 - Corian top tier with veneer or laminate body. **Wood species and finish selection must be specified.**
- » Two-tone finishing (top and bottom tier) available at no upcharge.
- » Premium wood finish upcharge applies to the following wood finishes. Refer to options section for pricing.
 - Super Matte Sable Beech
 - Alabaster Oak
 - Super Matte Sable Oak
- » For custom wood finishes, please add one-time upcharge of \$514 List per color per order.
- » For custom laminates, add \$642 List per color per order. Pre-approval required, please contact client services.
- » For Corian top, specify “-CO” next to model number. Corian top is affixed to table top surface increasing overall table height by 1/2". Please note that a 1/8" reveal will be present. For non-standard colors, please contact client services for pricing.
- » Metal legs available in standard and premium finishes. Beech wood leg also available.
- » Limited power capability available. Please contact client services for details and placement.
- » All dimensions are nominal.

CORIAN® COLORS:

- » CWN Designer White
- » CLN Linen
- » CTD Witch Hazel
- » CRC Rain Cloud
- » CGQ Grey Onyx
- » CSQ Stonique

SOLEIL OCCASIONAL TABLES // DESIGNED BY DAVID DAHL

STANDARD METAL LEG FINISHES:

- » **0405 Charcoal Grey**
- » **0535 Metallic Silver**

PREMIUM METAL LEG FINISHES:

- » **0605 Matte Black**
- » **0705 Matte Cotton**
- » **0788 Glossy Cotton**
- » **0805 Oasis**
- » **0905 Mint**
- » **1005 Mercury**
- » **1105 Canary**
- » **1205 Stone**
- » **1305 Sage**
- » **1405 Ice Blue**
- » **1505 Clay**

ORDERING REQUIREMENTS:



- » **Model number**
- » **Wood species**
- » **Wood finish**
- » **Metal leg finish**
- » **Options, as applicable**

SOLEIL OCCASIONAL TABLES // DESIGNED BY DAVID DAHL

ORDERING REQUIREMENTS:

- » Model number
- » Wood species
- » Wood finish
- » Metal leg finish
- » Options, as applicable

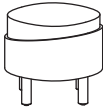
Note: Table with laminate or Corian top, finish selection for table body must be specified.

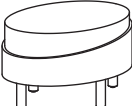
		MODEL NUMBER	VENEER OR LAMINATE	CORIAN (-CO)	WEIGHT (Veneer/Laminate Top)
440 	Round Table 18" Dia. x 16" H 18" Dia. x 20" H 24" Dia. x 16" H 36" Dia. x 16" H	440-1816	1751	2298	23
		440-1820	1869	2412	25
		440-2416	2073	2952	36
		440-3616	3394	5703	60
442 	Triangle Table 20" W x 20" L x 16" H 20" W x 20" L x 20" H 33" W x 33" L x 16" H	442-202016	1869	2370	25
		442-202020	2018	2499	27
		442-333316	2707	4658	66
447 	Ellipse Table 28" W x 20" L x 16" H 36" W x 24" L x 16" H	447-282016	2186	3115	32
		447-362416	2487	3746	47

OPTIONS

-WL01	Beech Wood Legs, specify finish	156
-NS04	Non-Skid Glides	29
-PFM01	Premium Metal Leg Finish	78
-PFW01	Premium Wood Finish, Legs	12
-PFW04	Premium Wood Finish, Table	44

THEME SEATING



arcadia

MARCH 1, 2026
VA IDIQ CONTRACT (FY26)
(DEALER HELD)

THEME GUEST // DESIGNED BY CHRIS & JON PANICHELLA



PRODUCT FEATURES:

- » Two back options: fully upholstered and wood shell with upholstered back cushion.
- » Seat features suspension support for optimum comfort.
- » Maximum weight capacity is 300 lbs.
- » All dimensions are nominal.

SPECIFICATIONS:

- » Available in beech and walnut, in all standard and custom wood finishes.
- » For Super Matte Sable Beech, premium wood finish upcharge applies. Refer to options section for pricing.
- » For custom wood finishes, please add one-time upcharge of \$514 List per color per order.



ORDERING REQUIREMENTS:

- » Model number
- » Wood species
- » Wood finish
- » Upholstery selection

THEME GUEST // DESIGNED BY CHRIS & JON PANICHELLA

ORDERING REQUIREMENTS:

- » Model number
- » Wood species
- » Wood finish
- » Upholstery selection

MODEL NUMBER	PRODUCT SPECIFICATIONS	FABRIC GRADES											LEATHER		
		WOOD SPECIES	COM	A	1	2	COL 3	4	5	6	7	8	L1	L2	
1410 	Guest Chair, Wood Back with Upholstered Cushion W 20 ¹ / ₄ D 22 H 31 ¹ / ₂ Seat Height 18 Inside Seat Width 19 ¹ / ₂ Inside Seat Depth 18 1 yd. 22 lbs. COL 20 sq. ft.	Beech	1488	1553	1585	1605	1637	1672	1705	1738	1769	1806	1957	2072	
		Walnut	2086	2151	2183	2203	2235	2270	2303	2336	2367	2404	2555	2670	
1411 	Guest Chair, Fully Upholstered W 20 ¹ / ₄ D 22 ¹ / ₄ H 31 ¹ / ₂ Seat Height 18 Inside Seat Width 19 ¹ / ₂ Inside Seat Depth 18 1 ¹ / ₂ yds. 21 lbs. COL 30 sq. ft.	Beech	1385	1483	1531	1561	1609	1661	1711	1760	1807	1862	2089	2261	
		Walnut	1982	2080	2128	2158	2206	2258	2308	2357	2404	2459	2686	2858	
OPTIONS															
-PFW03	Premium Wood Finish														34
-NS04	Non-Skid Glides														29

UPTOWN SOCIAL SEATING



arcadia

MARCH 1, 2026
VA IDIQ CONTRACT (FY26)
(DEALER HELD)

UPTOWN SOCIAL BENCHES // DESIGNED BY CHRIS & JON PANICHELLA



PRODUCT FEATURES:

- » Single, 2-seat, 3-seat benches as well as square and round models.
- » Select benches available with integrated tables.
- » Tables feature upholstered body with three top surface options.
- » Tufted stitching detail available on seat cushions, please refer to individual pages for applicable upcharge.
- » **The application of softer foam, together with inherent stretch properties among fabrics, may create varying degrees of comfort wrinkles on seat cushions.**
- » Die-cast aluminum legs feature adjustable glides.
- » Weight capacity listed on each page.
- » All dimensions are nominal.

SPECIFICATIONS:

- » Table tops offered in veneer, laminate or Corian.
- » Veneer offered in walnut and white oak, in all standard and custom wood finishes.
- » For Alabaster and Super Matte Sable Oak, premium wood finish upcharge applies. Refer to options section for pricing.
- » For custom laminates, add \$642 List per color per order. Pre-approval required, please contact client services.
- » Tables with veneer, standard wood grain or solid black laminate, edge finish will always match top finish color, unless otherwise specified.
- » For all other solid color laminates, edge will be natural exposed plywood with a clear coat finish as standard, unless otherwise specified.
- » For Corian top, specify "-CO" next to model number. Corian top is 1/2" thick and will increase overall table height by 1/4".
- » Optional wood trim is featured on all sides and can be specified in walnut and white oak, in all standard and custom finishes.
- » For custom wood finishes to tables and/or wood trim, please add one-time upcharge of \$514 List per color per order.
- » Metal legs available in standard and premium finishes.

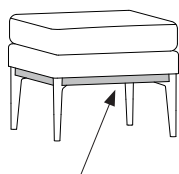

optional wood trim

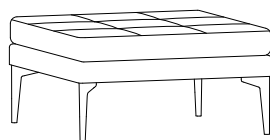

optional tufted stitching detail

UPTOWN SOCIAL BENCHES // DESIGNED BY CHRIS & JON PANICHELLA

CORIAN® COLORS:

- » CWN Designer White
- » CLN Linen
- » CTD Witch Hazel
- » CRC Rain Cloud
- » CGQ Grey Onyx
- » CSQ Stonique

STANDARD METAL BASE FINISHES:

- » 0299 Polished Aluminum
- » 0405 Charcoal Grey
- » 0535 Metallic Silver
- » 0630 Satin Black

PREMIUM METAL BASE FINISHES:

- » 0605 Matte Black
- » 0705 Matte Cotton
- » 0788 Glossy Cotton
- » 0805 Oasis
- » 0905 Mint
- » 1005 Mercury
- » 1105 Canary
- » 1205 Stone
- » 1305 Sage
- » 1405 Ice Blue
- » 1505 Clay

POWER UNITS:

- » For placement on integrated tables only.
- » Unit will be positioned in the center as standard, unless otherwise specified.
- » Black or white finish with 120" electrical cord (no hardwire option available for this series).
- » UL listed.

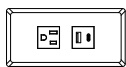

PX3
5⁷/₈" W x 2⁷/₈" D
One outlet, one USB-A and one USB-C charging port



PX4
7¹/₄" W x 2⁷/₈" D
Two outlets, one USB-A and one USB-C charging port



ORDERING REQUIREMENTS:

- » Model number
- » Metal leg finish
- » Upholstery selection, as applicable
- » Options, as applicable

UPTOWN SOCIAL BENCHES // DESIGNED BY CHRIS & JON PANICHELLA

ORDERING REQUIREMENTS:

- » Model number
- » Metal leg finish
- » Upholstery selection
- » Options, as applicable

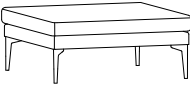
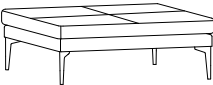

MODEL NUMBER	PRODUCT SPECIFICATIONS	FABRIC GRADES										LEATHER	
		COM	A	1	2	COL		3	4	5	6	7	8
5120-18 	18" Square Bench W 18 D 18 H 17 ¹ / ₄ 1 ¹ / ₂ yds. 19 lbs. COL 30 sq. ft.	1615	1713	1761	1791	1839	1891	1941	1990	2037	2092	2319	2491
5120-24 	24" Square Bench W 24 D 24 H 17 ¹ / ₄ 1 ³ / ₄ yds. 24 lbs. COL 35 sq. ft.	1873	1987	2043	2078	2134	2195	2253	2311	2365	2430	2694	2895
5120-30 	30" Square Bench W 30 D 30 H 17 ¹ / ₄ 2 ³ / ₄ yds. 33 lbs. COL 55 sq. ft.	2234	2413	2501	2556	2644	2740	2831	2922	3007	3109	3524	3840
5120-36 	36" Square Bench W 36 D 36 H 17 ¹ / ₄ 2 ³ / ₄ yds. 42 lbs. COL 55 sq. ft.	2718	2897	2985	3040	3128	3224	3315	3406	3491	3593	4008	4324
5120-42 	42" Square Bench W 42 D 42 H 17 ¹ / ₄ 4 yds. 53 lbs. COL 80 sq. ft.	3004	3264	3392	3472	3600	3740	3872	4004	4128	4276	4880	5340

OPTIONS			WEIGHT CAPACITY
-WT01	Wood Trim - 18" and 24" Square	375	#5120-18 350 lbs. #5120-24 350 lbs. #5120-30 350 lbs. #5120-36 700 lbs. #5120-42 700 lbs.
-WT02	Wood Trim - 30" and 36" Square	522	
-WT03	Wood Trim - 42" Square	637	
-TSS01	Tufted Stitch Detail	166	
-NS04	Non-Skid Glides	29	
-PFM04	Premium Metal Leg Finish	188	
-PFW02	Premium Wood Finish	22	

UPTOWN SOCIAL BENCHES // DESIGNED BY CHRIS & JON PANICHELLA

ORDERING REQUIREMENTS:

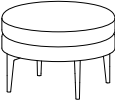
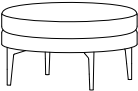
- » Model number
- » Metal leg finish
- » Upholstery selection
- » Options, as applicable

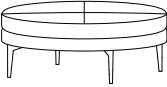
MODEL NUMBER	PRODUCT SPECIFICATIONS	FABRIC GRADES										LEATHER	
		COM	A	1	2	COL		3	4	5	6	7	8
5125-18 	18" Round Bench W 18 D 18 H 17 ¹ / ₄ 1 ¹ / ₄ yds. 16 lbs. COL 25 sq. ft.	1640	1722	1762	1787	1827	1870	1912	1953	1992	2038	2227	2370
5125-24 	24" Round Bench W 24 D 24 H 17 ¹ / ₄ 2 yds. 20 lbs. COL 40 sq. ft.	1857	1987	2051	2091	2155	2225	2291	2357	2419	2493	2795	3025
5125-30 	30" Round Bench W 30 D 30 H 17 ¹ / ₄ 3 yds. 40 lbs. COL 60 sq. ft.	2248	2443	2539	2599	2695	2800	2899	2998	3091	3202	3655	4000
5125-36 	36" Round Bench W 36 D 36 H 17 ¹ / ₄ 3 ¹ / ₂ yds. 56 lbs. COL 70 sq. ft.	2741	2969	3081	3151	3263	3385	3501	3616	3725	3854	4383	4785
5125-42 	42" Round Bench W 42 D 42 H 17 ¹ / ₄ 4 ¹ / ₂ yds. 69 lbs. COL 90 sq. ft.	3051	3344	3488	3578	3722	3879	4028	4176	4316	4482	5162	5679

OPTIONS		
-WT01	Wood Trim - 18" and 24" Round	375
-WT02	Wood Trim - 30" and 36" Round	522
-WT03	Wood Trim - 42" Round	637
-TSS01	Tufted Stitch Detail	166
-NS04	Non-Skid Glides	29
-PFM04	Premium Metal Leg Finish	188
-PFW02	Premium Wood Finish	22

WEIGHT CAPACITY

- #5125-18 350 lbs.
- #5125-24 350 lbs.
- #5125-30 350 lbs.
- #5125-36 700 lbs.
- #5125-42 700 lbs.

UPTOWN SOCIAL BENCHES // DESIGNED BY CHRIS & JON PANICHELLA

UPHOLSTERY COMBINATIONS:

- » When combining two COM/COV/COL fabrics, or fabrics with the same grade, add \$120 List per unit.
- » When combining three COM/COV/COL fabrics, or fabrics with the same grade, add \$150 List per unit.
- » When combining different grades of fabric, price will be based on the highest grade specified.
- » Two-tone upholstery examples and yardage requirements for the most common combinations are listed below. Additional combinations available, please contact client services for yardage requirements and pricing.
- » Note: Yardage amounts are based on fabric which is plain (i.e. non-directional) and a full 54" wide.
- » Appropriate upholstery code must be included.



Code US46
Model COM Requirement
 5120-18 Seat Cushion = 1¹/₄ yds.
 Balance of Bench = 3³/₄ yd.



Code US47
Model COM Requirement
 5120-24 Seat Cushion = 1¹/₂ yds.
 Balance of Bench = 1 yd.

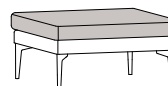

Code US48
Model COM Requirement
 5120-30 Seat Cushion = 2 yds.
 Balance of Bench = 1¹/₄ yds.

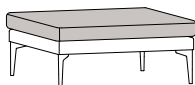

Code US49
Model COM Requirement
 5120-36 Seat Cushion = 2¹/₄ yds.
 Balance of Bench = 1¹/₄ yds.

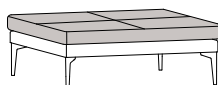

Code US50
Model COM Requirement
 5120-42 Seat Cushion = 3 yds.
 Balance of Bench = 1¹/₂ yds.



Code US51
Model COM Requirement
 5125-18 Seat Cushion = 1 yd.
 Balance of Bench = 3³/₄ yds.



Code US52
Model COM Requirement
 5125-24 Seat Cushion = 1¹/₂ yds.
 Balance of Bench = 1 yd.

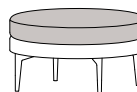

Code US53
Model COM Requirement
 5125-30 Seat Cushion = 2¹/₄ yds.
 Balance of Bench = 1 yd.

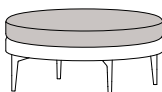

Code US54
Model COM Requirement
 5125-36 Seat Cushion = 2¹/₂ yds.
 Balance of Bench = 1¹/₄ yds.

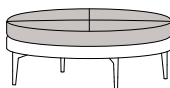

Code US55
Model COM Requirement
 5125-42 Seat Cushion = 3¹/₄ yds.
 Balance of Bench = 1¹/₂ yds.

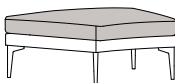

Code US24
Model COM Requirement
 5126 Seat Cushion = 3 yds.
 Balance of Bench = 1¹/₄ yds.

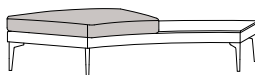

Code US25
Model COM Requirement
 5114-TL Seat Cushion = 3 yds.
 5114-TR Balance of Bench = 1¹/₂ yds.

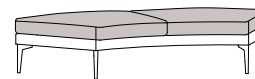

Code US26
Model COM Requirement
 5127 Seat Cushion = 6¹/₄ yds.
 Balance of Bench = 1¹/₂ yds.

UPTOWN SOCIAL BENCHES // DESIGNED BY CHRIS & JON PANICHELLA

UPHOLSTERY COMBINATIONS:

- » When combining two COM/COV/COL fabrics, or fabrics with the same grade, add \$120 List per unit.
- » When combining three COM/COV/COL fabrics, or fabrics with the same grade, add \$150 List per unit.
- » When combining different grades of fabric, price will be based on the highest grade specified.
- » Two-tone upholstery examples and yardage requirements for the most common combinations are listed below. Additional combinations available, please contact client services for yardage requirements and pricing.
- » Note: Yardage amounts are based on fabric which is plain (i.e. non-directional) and a full 54" wide.
- » Appropriate upholstery code must be included.

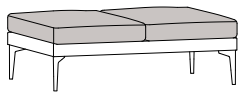

Code US56
Model 5128
COM Requirement
Seat Cushion = 2¹/₄ yds.
Balance of Bench = 1¹/₄ yds.

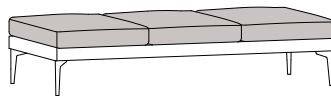

Code US57
Model 5129
COM Requirement
Seat Cushion = 3¹/₄ yds.
Balance of Bench = 1¹/₂ yds.

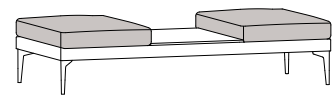

Code US58
Model 5129-T
COM Requirement
Seat Cushion = 3 yds.
Balance of Bench = 1¹/₂ yds.

UPTOWN SOCIAL LOUNGE + MODULAR //

DESIGNED BY CHRIS AND JON PANICHELLA



PRODUCT FEATURES:

- » Arm and armless lounge, love seat, sofa and chaise models available individually or in modular combinations with integrated tables and/or benches.
- » 4" and 7" arm widths available on lounge, love seat and sofa models. Chaise lounge available with 4" arm width only.
- » Back and seat cushions are removable for cleaning or replacement purposes.
- » Integrated tables feature upholstered body and three top surface options: veneer, laminate and Corian.
- » Stand-alone tables available in all wood or with upholstered body.
- » Die-cast aluminum legs feature adjustable glides for leveling purposes.
- » Maximum weight capacity is 350 lbs. for lounge chairs, 700 lbs. for love seats and chaise models, and 1000 lbs. for sofas.
- » Optional wood trim is featured on all sides below the seat or table frame. Available in walnut and white oak, in all standard and custom finishes, please refer to individual pages for applicable upcharge.
- » Tufted stitching detail available on back and seat cushion, please refer to individual pages for applicable upcharge.
- » **The application of softer foam, together with inherent stretch properties among fabrics, may create varying degrees of comfort wrinkles on seat and/or back cushions.**
- » All dimensions are nominal.

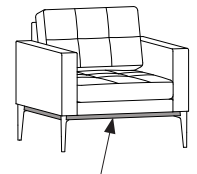

optional wood trim shown with tufting stitch detail

SEATING POWER UNITS:

- » Available on front or side of arms. Specify left or right, as seated.
- » Standard placement for seating units is depicted below. For placement elsewhere, please contact client services.
- » Black or white finish with 120" electrical cord (no hardwire option available for this series).
- » UL listed.



PX1
5¹/₄" W x 2¹/₂" D
One outlet, one USB-A and one USB-C charging port



PX2
6⁵/₈" W x 2¹/₂" D
Two outlets, one USB-A and one USB-C charging port

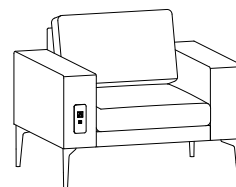

front of arm placement is 3" from the bottom of the frame, centered vertically

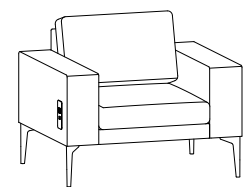

side of arm placement is 3" both vertically and horizontally from the bottom of the frame

UPTOWN SOCIAL LOUNGE + MODULAR //

DESIGNED BY CHRIS AND JON PANICHELLA

TABLE POWER UNITS:

- » Available on all table tops.
- » Unit will be positioned in the center of integrated tables, 5" from the rear, as standard, unless otherwise specified.
- » Black or white finish with 120" electrical cord (no hardwire option available for this series).
- » UL listed.

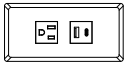

PX3
5⁷/₈" W x 2⁷/₈" D
One outlet, one USB-A and one USB-C charging port

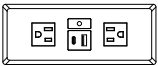

PX4
7¹/₄" W x 2⁷/₈" D
Two outlets, one USB-A and one USB-C charging port

MODULAR ARRANGEMENTS:

- » Optional ganging bracket connects two units together.
- » **Note: Please include layout drawings or sketch with order.**
- » Field assembly required.



SPECIFICATIONS:

- » Upholstery direction must be specified on corner units when patterned fabrics are selected. In the absence of specific instructions, Arcadia reserves the right to upholster units at our discretion.

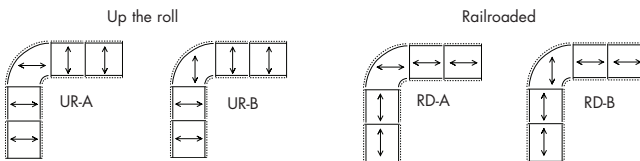

- » Optional wood arm cap offered in walnut or white oak, as well as Corian.
- » Integrated table tops available in walnut and white oak veneer, laminate or Corian (body is always upholstered).
- » For integrated tables with veneer, standard wood grain or solid black laminate, edge finish will always match top finish color, unless otherwise specified. All other solid color laminates, edge will be natural exposed plywood with a clear coat finish as standard, unless otherwise specified.
- » Stand-alone tables available with upholstered body, or as follows:
 - Walnut or white oak veneer top with matching veneer body as standard, unless otherwise specified.
 - Laminate top with laminate body as standard, unless otherwise specified.
 - Corian top with veneer or laminate body. **Wood species and finish selection must be specified.**
- » For Alabaster and Super Matte Sable Oak, premium wood finish upcharge applies. Refer to options section for pricing.
- » For custom wood finishes to tables, wood trim and/or pull-up table, please add one-time upcharge of \$514 List per color per order.
- » For custom laminates, add \$642 List per color per order. Pre-approval required, please contact client services.
- » For Corian top, specify "-CO" next to model number. For all wood tables, Corian is affixed to top surface increasing overall table height by 1/2". Additionally, a 1/8" reveal will be present. When specified with upholstered sides, Corian top will increase overall table height by 1/4".
- » Die-cast aluminum legs available in standard and premium finishes, options listed below.

STANDARD METAL BASE FINISHES:

- » 0299 Polished Aluminum
- » 0405 Charcoal Grey
- » 0535 Metallic Silver
- » 0630 Satin Black

PREMIUM METAL BASE FINISHES:

- » 0605 Matte Black
- » 0705 Matte Cotton
- » 0788 Glossy Cotton
- » 0805 Oasis
- » 0905 Mint
- » 1005 Mercury
- » 1105 Canary
- » 1205 Stone
- » 1305 Sage
- » 1405 Ice Blue
- » 1505 Clay

UPTOWN SOCIAL LOUNGE + MODULAR //

DESIGNED BY CHRIS AND JON PANICHELLA

CORIAN® COLORS:

- » **CWN Designer White**
- » **CLN Linen**
- » **CTD Witch Hazel**
- » **CRC Rain Cloud**
- » **CGQ Grey Onyx**
- » **CSQ Stonique**

ORDERING REQUIREMENTS:

- » **Model number**
- » **Metal leg finish**
- » **Upholstery selection**
- » **Options, as applicable**

UPTOWN SOCIAL LOUNGE + MODULAR //

DESIGNED BY CHRIS AND JON PANICHELLA

ORDERING REQUIREMENTS:

- » Model number
- » Metal leg finish
- » Upholstery selection
- » Options, as applicable

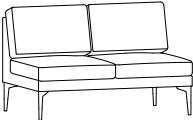
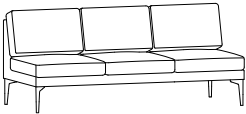
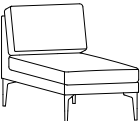
MODEL NUMBER	PRODUCT SPECIFICATIONS	FABRIC GRADES										LEATHER	
		COM	A	1	2	COL		3	4	5	6	7	8
5101 	% Lounge Chair, Armless W 25 D 31 ³ / ₄ H 31 Seat Height 17 ¹ / ₄ Inside Seat Width 25 Inside Seat Depth 22 3 ¹ / ₂ yds. 42 lbs. COL 70 sq. ft.	2192	2420	2532	2602	2714	2836	2952	3067	3176	3305	3834	4236
5102 	Love Seat, Armless W 50 D 31 ³ / ₄ H 31 Seat Height 17 ¹ / ₄ Inside Seat Width 50 Inside Seat Depth 22 5 ³ / ₄ yds. 62 lbs. COL 115 sq. ft.	3054	3428	3612	3727	3911	4112	4302	4492	4670	4883	5751	6412
5103 	Sofa, Armless W 75 D 31 ³ / ₄ H 31 Seat Height 17 ¹ / ₄ Inside Seat Width 75 Inside Seat Depth 22 9 yds. 97 lbs. COL 180 sq. ft.	4514	5099	5387	5567	5855	6170	6467	6764	7043	7376	8735	9770
5105 	Chaise Lounge, Armless W 25 D 57 ³ / ₄ H 31 Seat Height 17 ¹ / ₄ Inside Seat Width 25 Inside Seat Depth 47 5 ³ / ₄ yds. 61 lbs. COL 115 sq. ft.	2718	3092	3276	3391	3575	3776	3966	4156	4334	4547	5415	6076

To add single arms, please refer to page 9

OPTIONS		
-WT01	Wood Trim - Lounge Chair	375
-WT02	Wood Trim - Love Seat & Chaise Lounge	522
-WT03	Wood Trim - Sofa	637
-TSB01	Tufted Stitch Detail, Back Cushion (per cushion)	133
-TSS01	Tufted Stitch Detail, Seat Cushion (per cushion)	166
-TSS02	Tufted Stitch Detail, Chaise Lounge Seat Cushion	193
-NS04	Non-Skid Glides	29
-PFM04	Premium Metal Leg Finish	188
-PFW02	Premium Wood Finish, Wood Trim	22
-GC07 (ordered separately)	Ganging Connector	102



% = Available on quick-ship program (standard finishes only).

UPTOWN SOCIAL LOUNGE + MODULAR //

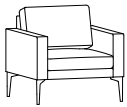

DESIGNED BY CHRIS AND JON PANICHELLA

ORDERING REQUIREMENTS:

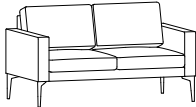
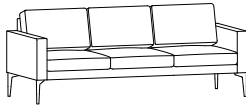
- » Model number
- » Metal leg finish
- » Upholstery selection
- » Options, as applicable

MODEL NUMBER	PRODUCT SPECIFICATIONS	FABRIC GRADES										LEATHER				
		COM	A	1	2	COL					3	4	5	6	7	8
5101-4LR 	 Lounge Chair, 4\" Arms W 33 D 31 ³ / ₄ H 31 Seat Height 17 ¹ / ₄ Inside Seat Width 25 Inside Seat Depth 22 6 ¹ / ₂ yds. 65 lbs. COL 130 sq. ft.	2879	3302	3510	3640	3848	4075	4290	4504	4706	4946	5928	6675			
5102-4LR 	Love Seat, 4\" Arms W 58 D 31 ³ / ₄ H 31 Seat Height 17 ¹ / ₄ Inside Seat Width 50 Inside Seat Depth 22 8 ³ / ₄ yds. 95 lbs. COL 175 sq. ft.	3741	4310	4590	4765	5045	5351	5640	5929	6200	6524	7845	8851			
5103-4LR 	Sofa, 4\" Arms W 83 D 31 ³ / ₄ H 31 Seat Height 17 ¹ / ₄ Inside Seat Width 75 Inside Seat Depth 22 12 yds. 120 lbs. COL 240 sq. ft.	5201	5981	6365	6605	6989	7409	7805	8201	8573	9017	10829	12209			

OPTIONS

-WC01	4\" Wood Arm Cap, Per Arm	427
-CO05	4\" Corian Arm Cap, Per Arm	232
-WT01	Wood Trim - Lounge Chair	375
-WT02	Wood Trim - Love Seat & Chaise Lounge	522
-WT03	Wood Trim - Sofa	637
-TSB01	Tufted Stitch Detail, Back Cushion (per cushion)	133
-TSS01	Tufted Stitch Detail, Seat Cushion (per cushion)	166
-NS04	Non-Skid Glides	29
-PFM04	Premium Metal Leg Finish	188
-PFW01	Premium Wood Finish, Arm Cap (per arm)	12
-PFW02	Premium Wood Finish, Wood Trim	22
-PX1(-)	 Power Matrix 1 (one power, one USB-A, one USB-C)	514
-PX2(-)	 Power Matrix 2 (dual power, one USB-A, one USB-C)	538
-GC07 (ordered separately)	Ganging Connector	102

Note: For power matrix faceplate, please specify black (-B) or white (-W) finish.



 = Available on quick-ship program (standard finishes only). PX1 and PX2 power unit quick-ship applies to model 5101-4LR only.



UPTOWN SOCIAL LOUNGE + MODULAR //

DESIGNED BY CHRIS AND JON PANICHELLA

ORDERING REQUIREMENTS:

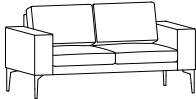
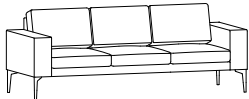
- » Model number
- » Metal leg finish
- » Upholstery selection
- » Options, as applicable

MODEL NUMBER	PRODUCT SPECIFICATIONS	FABRIC GRADES										LEATHER				
		COM	A	1	2	COL					3	4	5	6	7	8
5101-7LR 	 Lounge Chair, 7" Arms W 39 D 31 ³ / ₄ H 31 Seat Height 17 ¹ / ₄ Inside Seat Width 25 Inside Seat Depth 22 6 ¹ / ₂ yds. 75 lbs. COL 130 sq. ft.	2942	3365	3573	3703	3911	4138	4353	4567	4769	5009	5991	6738			
5102-7LR 	Love Seat, 7" Arms W 64 D 31 ³ / ₄ H 31 Seat Height 17 ¹ / ₄ Inside Seat Width 50 Inside Seat Depth 22 8 ³ / ₄ yds. 105 lbs. COL 175 sq. ft.	3804	4373	4653	4828	5108	5414	5703	5992	6263	6587	7908	8914			
5103-7LR 	Sofa, 7" Arms W 89 D 31 ³ / ₄ H 31 Seat Height 17 ¹ / ₄ Inside Seat Width 75 Inside Seat Depth 22 12 yds. 130 lbs. COL 240 sq. ft.	5264	6044	6428	6668	7052	7472	7868	8264	8636	9080	10892	12272			

OPTIONS		
-WC02	7" Wood Arm Cap, Per Arm	470
-CO06	7" Corian Arm Cap, Per Arm	307
-WT01	Wood Trim - Lounge Chair	375
-WT02	Wood Trim - Love Seat & Chaise Lounge	522
-WT03	Wood Trim - Sofa	637
-TSB01	Tufted Stitch Detail, Back Cushion (per cushion)	133
-TSS01	Tufted Stitch Detail, Seat Cushion (per cushion)	166
-NS04	Non-Skid Glides	29
-PFM04	Premium Metal Leg Finish	188
-PFW01	Premium Wood Finish, Arm Cap (per arm)	12
-PFW02	Premium Wood Finish, Wood Trim	22
-PX1(-)	 Power Matrix 1 (one power, one USB-A, one USB-C)	514
-PX2(-)	 Power Matrix 2 (dual power, one USB-A, one USB-C)	538
-GC07 (ordered separately)	Ganging Connector	102

Note: For power matrix faceplate, please specify black (-B) or white (-W) finish.

 = Available on quick-ship program (standard finishes only). PX1 and PX2 power unit quick-ship applies to model 5101-7LR only.

UPTOWN SOCIAL LOUNGE + MODULAR //

DESIGNED BY CHRIS AND JON PANICHELLA

ORDERING REQUIREMENTS:

- » Model number
- » Upholstery selection
- » Options, as applicable

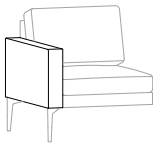
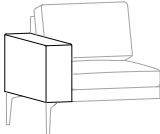
MODEL NUMBER	PRODUCT SPECIFICATIONS	FABRIC GRADES										LEATHER	
		COM	A	1	2	COL		3	4	5	6	7	8
XXXX-4LA (LEFT ARM) XXXX-4RA (RIGHT ARM) 	4" End Arm, specify placement as seated 1 1/2 yds. 12 lbs. COL 30 sq. ft.	346	444	492	522	570	622	672	721	768	823	1050	1222
XXXX-7LA (LEFT ARM) XXXX-7RA (RIGHT ARM) 	7" End Arm, specify placement as seated 1 1/2 yds. 17 lbs. COL 30 sq. ft.	376	474	522	552	600	652	702	751	798	853	1080	1252

OPTIONS		
-WC01	4" Wood Arm Cap, Per Arm	427
-CO05	4" Corian Arm Cap, Per Arm	232
-WC02	7" Wood Arm Cap, Per Arm	470
-CO06	7" Corian Arm Cap, Per Arm	307
-PFW01	Premium Wood Finish, Arm Cap (per arm)	22
-PX1(-)	Power Matrix 1 (one power, one USB-A, one USB-C)	514
-PX2(-)	Power Matrix 2 (dual power, one USB-A, one USB-C)	538

Note: For power matrix faceplate, please specify black (-B) or white (-W) finish.



UPTOWN SOCIAL LOUNGE + MODULAR //

DESIGNED BY CHRIS AND JON PANICHELLA

ORDERING REQUIREMENTS:

- » Model number
- » Table wood species
- » Table wood finish
- » Metal leg finish
- » Upholstery selection
- » Options, as applicable

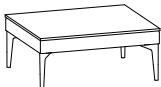
Note: For Corian top, specify '-CO' after model number and add appropriate upcharge. Body is veneer or laminate, finish must be specified.

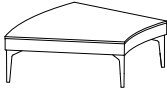
MODEL NUMBER	PRODUCT SPECIFICATIONS	FABRIC GRADES										LEATHER	
		COM	A	1	2	COL		3	4	5	6	7	8
5115-2531-U 	25" Wide Table, Wood Top with Upholstered Body W 25 D 31 H 12 ¹ / ₄ 3/4 yd. 29 lbs. COL 15 sq. ft.	1607	1656	1680	1695	1719	1745	1770	1795	1818	1846	1959	2045
5115-3131-U 	31" Wide Table, Wood Top with Upholstered Body W 31 D 31 H 12 ¹ / ₄ 1 yd. 31 lbs. COL 20 sq. ft.	1889	1954	1986	2006	2038	2073	2106	2139	2170	2207	2358	2473
5116-U 	30-Degree Table, Wood Top with Upholstered Body W 31 D 31 H 12 ³ / ₄ 1 yd. 30 lbs. COL 20 sq. ft.	1784	1849	1881	1901	1933	1968	2001	2034	2065	2102	2253	2368

OPTIONS		
-WT01	Wood Trim	375
-COT03	Corian Table Top, 25" Wide Table	1503
-COT04	Corian Table Top, 31" Wide Table and 30-Degree Table	2067
-NS04	Non-Skid Glides	29
-PFM04	Premium Metal Leg Finish	188
-PFW02	Premium Wood Finish, Wood Trim	22
-PFW04	Premium Wood Finish, Table Top	44
-PX3-()	Power Matrix 3 (one power, one USB-A, one USB-C)	514
-PX4-()	Power Matrix 4 (dual power, one USB-A, one USB-C)	538
-GC07 (ordered separately)	Ganging Connector	102

Note: For power matrix faceplate, please specify black (-B) or white (-W) finish.



UPTOWN SOCIAL LOUNGE + MODULAR //

DESIGNED BY CHRIS AND JON PANICHELLA

ORDERING REQUIREMENTS:

- » Model number
- » Wood species
- » Wood finish
- » Metal leg finish
- » Options, as applicable

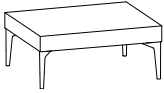
Note: For Corian tops, specify '-CO' after model number and select color. Body is veneer or laminate, finish must be specified.

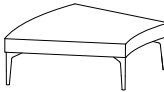
MODEL NUMBER	PRODUCT SPECIFICATIONS	TABLE TOP FINISH	
		VENEER OR LAMINATE	CORIAN (-CO)
 <p>5115-2531-W</p>	<p>25" Wide Table, Wood Top & Body W 25 D 31 H 12¹/₄ 29 lbs.</p>	1845	3348
 <p>5115-3131-W</p>	<p>31" Wide Table, Wood Top & Body W 31 D 31 H 12¹/₄ 31 lbs.</p>	2076	4143
 <p>5116-W</p>	<p>30-Degree Table, Wood Top & Body W 31 D 31 H 12¹/₄ 30 lbs.</p>	2076	4143

OPTIONS		
-WT01	Wood Trim	375
-NS04	Non-Skid Glides	29
-PFM04	Premium Metal Leg Finish	188
-PFW02	Premium Wood Finish, Wood Trim	22
-PFW04	Premium Wood Finish, Table Top	44
-PX3(-)	Power Matrix 3 (one power, one USB-A, one USB-C)	514
-PX4(-)	Power Matrix 4 (dual power, one USB-A, one USB-C)	538
-GC07 (ordered separately)	Ganging Connector	102

Note: For power matrix faceplate, please specify black (-B) or white (-W) finish.

UPTOWN SOCIAL LOUNGE + MODULAR //

DESIGNED BY CHRIS AND JON PANICHELLA

ORDERING REQUIREMENTS:

- » Model number
- » Upholstery selection

Note: Pillows are upholstered on both sides, with concealed zipper enclosure.

Note: Vinyl, polyurethane and leather upholstery not available.

MODEL NUMBER	PRODUCT SPECIFICATIONS	FABRIC GRADES									
		COM	A	1	2	3	4	5	6	7	8
5118-1616	16" Square Pillow W 16 D 3 H 16 3/4 yd. 1 lb.	172	221	245	260	284	310	335	360	383	411
5118-1818	18" Square Pillow W 18 D 3 H 18 3/4 yd. 1 lb.	178	227	251	266	290	316	341	366	389	417
5118-2020	20" Square Pillow W 20 D 3 H 20 3/4 yd. 1 lb.	188	237	261	276	300	326	351	376	399	427
5118-1018	10" x 18" Rectangle Pillow W 18 D 3 H 10 1/2 yd. 1 lb.	176	209	225	235	251	268	285	301	317	335
5119	6" x 18" Bolster Pillow Dia. 6 L 18 3/4 yd. 1 lb.	223	272	296	311	335	361	386	411	434	462

UPTOWN SOCIAL LOUNGE + MODULAR //

DESIGNED BY CHRIS AND JON PANICHELLA

CONFIGURATION EXAMPLES

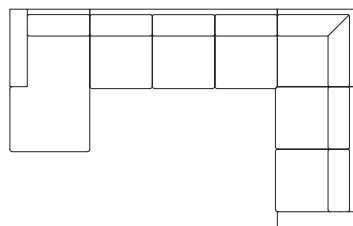

Qty	Model #	Description	COM List
1	5102-4LA	Love Seat, Left Arm (as seated)	\$3,400
1	5104	Corner Unit	\$2,426
1	5103	Armless Sofa	\$4,514
<u>1</u>	<u>5105-4RA</u>	<u>Chaise Lounge, Right Arm (as seated)</u>	<u>\$3,064</u>
4			\$13,404

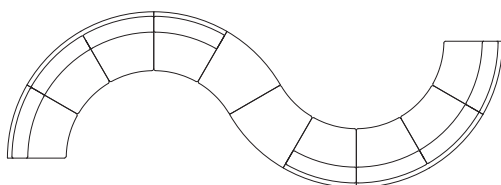

Qty	Model #	Description	COM List
2	5106	30-Degree Single Seat, Armless (\$2,718 each)	\$5,436
2	5107	60-Degree Two-Seat, Armless (\$4,514 each)	\$9,028
<u>2</u>	<u>5113-TL</u>	<u>60-Degree Lounge/Table Combination (\$4,331 each)</u>	<u>\$8,662</u>
6			\$23,126

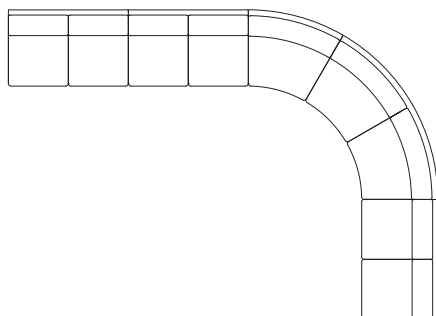

Qty	Model #	Description	COM List
3	5102	Armless Love Seat (\$3,054 each)	\$9,162
1	5107	60-Degree Two-Seat, Armless	\$4,514
<u>1</u>	<u>5106</u>	<u>30-Degree Single Seat, Armless</u>	<u>\$2,718</u>
5			\$16,394

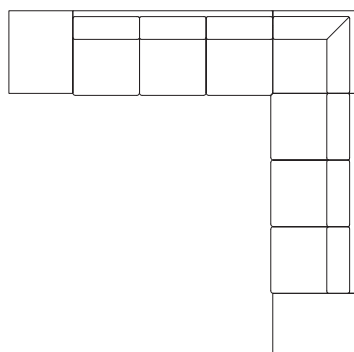

Qty	Model #	Description	COM List
2	5115-2531-W	25" Wide Tables (\$1,845 each)	\$3,690
2	5103	Armless Sofa (\$4,514 each)	\$9,028
<u>1</u>	<u>5104</u>	<u>Corner Unit</u>	<u>\$2,426</u>
5			\$15,144

Note: Uptown Social ganging connectors not included in pricing examples as shown above.

UPTOWN SOCIAL LOUNGE + MODULAR //

DESIGNED BY CHRIS AND JON PANICHELLA

UPHOLSTERY COMBINATIONS:

- » When combining two COM/COV/COL fabrics, or fabrics with the same grade, add \$120 List per unit.
- » When combining three COM/COV/COL fabrics, or fabrics with the same grade, add \$150 List per unit.
- » When combining different grades of fabric, price will be based on the highest grade specified.
- » Two-tone upholstery examples and yardage requirements for the most common combinations are listed below. Additional combinations available, please contact client services for yardage requirements and pricing.
- » Note: Yardage amounts are based on fabric which is plain (i.e. non-directional) and a full 54" wide.
- » Appropriate upholstery code must be included.



Code US1
Model COM Requirement
 5101 Seat Cushion Only = 1³/₄ yds.
 Balance of Chair = 2¹/₂ yds.

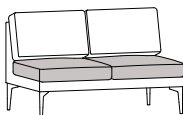

Code US2
Model COM Requirement
 5102 Seat Cushion Only = 2¹/₂ yds.
 Balance of Chair = 3³/₄ yds.

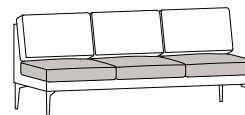

Code US3
Model COM Requirement
 5103 Seat Cushion Only = 3³/₄ yds.
 Balance of Chair = 5¹/₂ yds.



Code US4
Model COM Requirement
 5105 Seat Cushion Only = 2¹/₂ yds.
 Balance of Chair = 2¹/₂ yds.

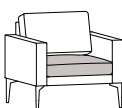

Code US5
Model COM Requirement
 5101-4LR Seat Cushion Only = 1³/₄ yds.
 Balance of Chair = 4 yds.

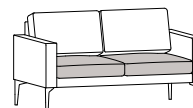

Code US6
Model COM Requirement
 5102-4LR Seat Cushion Only = 2¹/₂ yds.
 Balance of Chair = 5¹/₄ yds.

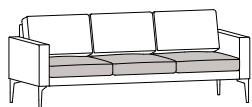

Code US7
Model COM Requirement
 5103-4LR Seat Cushion Only = 3³/₄ yds.
 Balance of Chair = 7 yds.

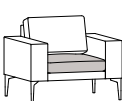

Code US8
Model COM Requirement
 5101-7LR Seat Cushion Only = 1³/₄ yds.
 Balance of Chair = 4 yds.

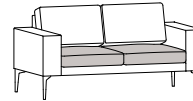

Code US9
Model COM Requirement
 5102-7LR Seat Cushion Only = 2¹/₂ yds.
 Balance of Chair = 5¹/₄ yds.

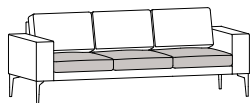

Code US10
Model COM Requirement
 5103-7LR Seat Cushion Only = 3³/₄ yds.
 Balance of Chair = 7 yds.



Code US11
Model COM Requirement
 5104 Seat Cushion Only = 1¹/₂ yds.
 Balance of Chair = 4¹/₄ yds.

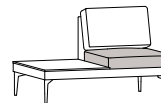

Code US12
Model COM Requirement
 5111-TL Seat Cushion Only = 3³/₄ yds.
 5111-TR Balance of Chair = 2³/₄ yds.

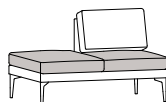

Code US13
Model COM Requirement
 5111-BL Seat Cushion Only = 3 yds.
 5111-BR Balance of Chair = 2³/₄ yds.

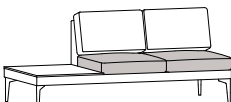

Code US14
Model COM Requirement
 5112-TL Seat Cushion Only = 2¹/₂ yds.
 5112-TR Balance of Chair = 4¹/₄ yds.

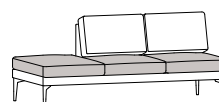

Code US15
Models COM Requirement
 5112-BR Seat Cushion Only = 3³/₄ yds.
 5112-BL Balance of Chair = 4¹/₂ yds.

UPTOWN SOCIAL LOUNGE + MODULAR //

DESIGNED BY CHRIS AND JON PANICHELLA

UPHOLSTERY COMBINATIONS:

- » When combining two COM/COV/COL fabrics, or fabrics with the same grade, add \$120 List per unit.
- » When combining three COM/COV/COL fabrics, or fabrics with the same grade, add \$150 List per unit.
- » When combining different grades of fabric, price will be based on the highest grade specified.
- » Two-tone upholstery examples and yardage requirements for the most common combinations are listed below. Additional combinations available, please contact client services for yardage requirements and pricing.
- » Note: Yardage amounts are based on fabric which is plain (i.e. non-directional) and a full 54" wide.
- » Appropriate upholstery code must be included.



Code US16
Model COM Requirement
 5121 Seat Cushion Only = 1¹/₂ yds.
 Balance of Chair = 1 yd.

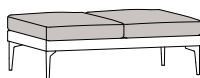

Code US17
Model COM Requirement
 5122 Seat Cushion Only = 3 yds.
 Balance of Chair = 1¹/₄ yds.

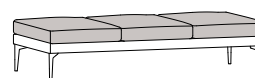

Code US18
Models COM Requirement
 5123 Seat Cushion Only = 4¹/₄ yds.
 Balance of Chair = 1¹/₂ yds.

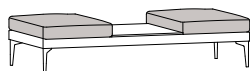

Code US19
Model COM Requirement
 5124 Seat Cushion Only = 3 yds.
 Balance of Chair = 1¹/₂ yds.



Code US20
Model COM Requirement
 5106 Seat Cushion Only = 2¹/₄ yds.
 Balance of Chair = 3¹/₄ yds.

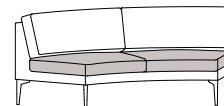

Code US21
Models COM Requirement
 5107 Seat Cushion Only = 4¹/₄ yds.
 Balance of Chair = 6³/₄ yds.

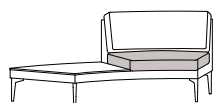

Code US22
Model COM Requirement
 5113-TL Seat Cushion Only = 3³/₄ yds.
 5113-TR Balance of Chair = 2 yds.

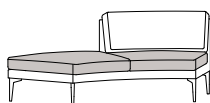

Code US23
Model COM Requirement
 5113-BL Seat Cushion Only = 4¹/₂ yds.
 5113-BR Balance of Chair = 3³/₄ yds.



Code US24
Model COM Requirement
 5126 Seat Cushion Only = 3 yds.
 Balance of Bench = 1¹/₄ yds.

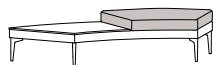

Code US25
Model COM Requirement
 5114-TL Seat Cushion = 3 yds.
 5114-TR Balance of Bench = 1¹/₂ yds.

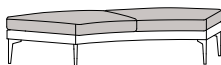

Code US26
Model COM Requirement
 5127 Seat Cushion = 6¹/₄ yds.
 Balance of Bench = 1¹/₂ yds.

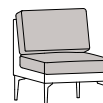

Code US27
Model COM Requirement
 5101 Back & Seat Cushion = 2¹/₂ yds.
 Balance of Chair = 2 yds.

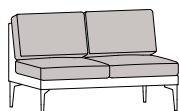

Code US28
Model COM Requirement
 5102 Back & Seat Cushion = 3³/₄ yds.
 Balance of Chair = 2³/₄ yds.

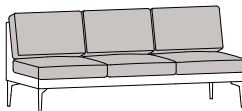

Code US29
Models COM Requirement
 5103 Back & Seat Cushion = 5¹/₄ yds.
 Balance of Chair = 3¹/₂ yds.

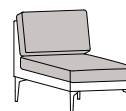

Code US30
Model COM Requirement
 5105 Back & Seat Cushion = 3 yds.
 Balance of Chair = 2¹/₂ yds.

UPTOWN SOCIAL LOUNGE + MODULAR //

DESIGNED BY CHRIS AND JON PANICHELLA

UPHOLSTERY COMBINATIONS:

- » When combining two COM/COV/COL fabrics, or fabrics with the same grade, add \$120 List per unit.
- » When combining three COM/COV/COL fabrics, or fabrics with the same grade, add \$150 List per unit.
- » When combining different grades of fabric, price will be based on the highest grade specified.
- » Two-tone upholstery examples and yardage requirements for the most common combinations are listed below. Additional combinations available, please contact client services for yardage requirements and pricing.
- » Note: Yardage amounts are based on fabric which is plain (i.e. non-directional) and a full 54" wide.
- » Appropriate upholstery code must be included.

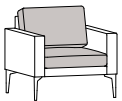

Code US31
Model 5101-4LR
COM Requirement
 Back & Seat Cushion = 2¹/₂ yds.
 Balance of Chair = 3¹/₂ yds.

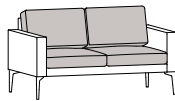

Code US32
Models 5102-4LR
COM Requirement
 Back & Seat Cushion = 3³/₄ yds.
 Balance of Chair = 4¹/₄ yds.

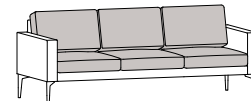

Code US33
Model 5103-4LR
COM Requirement
 Back & Seat Cushion = 5¹/₄ yds.
 Balance of Chair = 5 yds.



Code US34
Model 5101-7LR
COM Requirement
 Back & Seat Cushion = 2¹/₂ yds.
 Balance of Chair = 3¹/₂ yds.

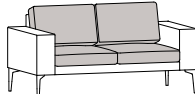

Code US35
Model 5102-7LR
COM Requirement
 Back & Seat Cushion = 3³/₄ yds.
 Balance of Chair = 4¹/₄ yds.

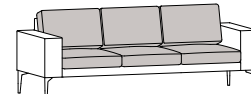

Code US36
Model 5103-7LR
COM Requirement
 Back and Seat Cushion = 5¹/₄ yds.
 Balance of Chair = 5 yds.



Code US37
Model 5104
COM Requirement
 Back and Seat Cushion = 3 yds.
 Balance of Chair = 3¹/₄ yds.

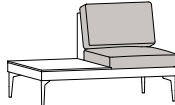

Code US38
Model 5111-TR
COM Requirement
 Back and Seat Cushion = 2¹/₂ yds.
 5111-TL Balance of Chair = 2 yds.

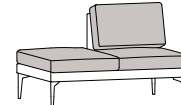

Code US39
Model 5111-BR
COM Requirement
 Back & Seat Cushion = 3¹/₂ yds.
 5111-BL Balance of Chair = 2 yds.

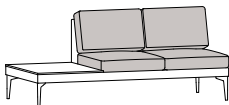

Code US40
Model 5112-TL
COM Requirement
 Back & Seat Cushion = 4 yds.
 5112-TR Balance of Chair = 3 yds.

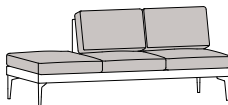

Code US41
Model 5112-BL
COM Requirement
 Back & Seat Cushion = 5¹/₄ yds.
 5112-BR Balance of Chair = 3¹/₄ yds.

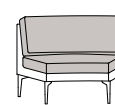

Code US42
Model 5106
COM Requirement
 Back & Seat Cushion = 3¹/₄ yds.
 Balance of Chair = 2¹/₄ yds.

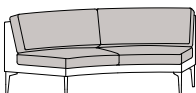

Code US43
Model 5107
COM Requirement
 Back & Seat Cushion = 6¹/₄ yds.
 Balance of Chair = 4¹/₂ yds.

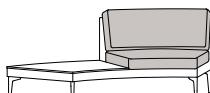

Code US44
Models 5113-TL
COM Requirement
 Back & Seat Cushion = 3 yds.
 5113-TR Balance of Chair = 2¹/₂ yds.

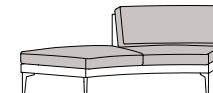

Code US45
Model 5113-BL
COM Requirement
 Back & Seat Cushion = 5³/₄ yds.
 5113-BR Balance of Chair = 2³/₄ yds.